



lancaster
moble

Autumn Sunrise Subdivision

Transportation Impact
Analysis

Tualatin, Oregon

Date:

September 20, 2021a

Prepared for:

David Force, Lennar Northwest

Copy:

Mimi Doukas, AKS Engineering & Forestry, LLC

Prepared by:

Nick Mesler, EIT

Jennifer Danziger, PE



RENEWS: 12-31-21

Executive Summary	4
Project Description	6
Introduction	6
Location Description	6
Site Trips	11
Trip Generation	11
Trip Distribution	13
Traffic Volumes	19
Existing Conditions	19
Background Conditions	23
Buildout Conditions	24
Safety Analysis	31
Crash History Review	31
Sight Distance	34
Access Spacing	35
Warrant Analysis	35
Operational Analysis	38
Intersection Capacity Analysis	38
Performance Standards	38
Delay & Capacity Analysis	38
Queue Storage	44
Conclusions	45
Appendix A – Site Data	
Appendix B – Traffic Counts	
Appendix C – Safety	
Appendix D - Operations	
Appendix E – Commercial Scenarios	



List of Figures

Figure 1: Project Vicinity and Intersection Lane Geometry	7
Figure 2A: Trip Distribution	14
Figure 2B: Trip Distribution with Basalt Creek Parkway Extension	15
Figure 3A: Trip Assignment – Phases 1 – 2	16
Figure 3B: Trip Assignment – Phases 1 – 4	17
Figure 3C: Trip Assignment – Phases 1 – 4 with Basalt Parkway Extension	18
Figure 4: Existing Traffic Volumes	22
Figure 5A: Year 2024 Background Conditions	25
Figure 5B: Year 2026 Background Conditions	26
Figure 5C: Year 2026 Background Conditions with Basalt Parkway Extension	27
Figure 6A: Year 2024 Buildout Conditions	28
Figure 6B: Year 2026 Buildout Conditions	29
Figure 6C: Year 2026 Buildout Conditions with Basalt Parkway Extension	30

List of Tables

Table 1: Roadway Characteristics	8
Table 2: Vicinity Intersection Descriptions	9
Table 3: Trip Generation Summary	11
Table 4: Trip Generation by Phase	12
Table 5: Year 2021 Existing Condition Traffic Volume Development	19
Table 6: Crash Type Summary	31
Table 7: Crash Severity and Rate Summary	32
Table 8: Summary of Left-Turn Lane Warrant Evaluation	36
Table 9: Summary of Right-Turn Lane Warrant Evaluation	36
Table 10: Summary of Preliminary Traffic Signal Warrant Evaluation	37
Table 11: Capacity Analysis Summary	39
Table 12: Capacity Analysis Summary – I-5 Southbound Off- Ramp with RTP Improvement	44

Executive Summary

1. The proposed Autumn Sunrise Subdivision includes the development of 400 residential lots on a site located south of SW Norwood Road, west of Interstate 5, north of SW Greenhill Lane, and east of SW Boones Ferry Road in Tualatin, Oregon. Although the site also includes two lots zoned for neighborhood commercial use, this report does not incorporate the impacts of the future commercial development on those lots. In coordination with agency staff, a separate land use application and traffic study will be prepared at the time that development of those lots is proposed.
2. The site will initially take all access from SW Norwood Road but includes a connection to SW Boones Ferry Road will be added with later phases.
3. The project site (Tax Lots 2S135D 100, 400, 401, 500, 501, 600, 800, & 900) is approximately 61.99 acres and is zoned medium low density residential. The surrounding land uses are compatible to the proposed project, consisting of predominately residential neighborhoods and schools that serve the residents.
4. The proposed development is estimated to generate 271 morning peak hour, 358 evening peak hour, and 3,596 daily trips.
5. Based on a review of the most recent five years of available crash data, no significant trends or crash patterns were identified at any of the study intersections. Accordingly, no safety mitigation is recommended per the crash data analysis.
6. At the proposed site access on SW Boones Ferry Road, field observations show that at least 500 feet is available looking in either direction as measured from the edge of the closest vehicular travel lane.
7. At the proposed site accesses on SW Norwood Road, dense foliage restricts existing sight lines; however, preliminary assessment of horizontal and vertical curvature indicate that the 500-foot sight distance requirement is expected to be satisfied.
8. On SW Boones Ferry Road, the access spacing standard of 600 feet will not be met with construction of the access aligned opposite a future frontage road connection on the west side of the street, as requested by Washington County. Overall spacing will be improved with consolidation of access on the street's east side.
9. On SW Norwood Road, the access spacing standard of 100 feet will be met with construction of the site accesses aligned opposite existing roadways.
10. Left-turn lane warrants are not met at either proposed site access intersection on SW Norwood Road for either peak hour under the 2026 buildout scenario for any analysis period or direction of travel.
11. Right-turn lane warrants are met at the proposed site access on SW Boones Ferry Road under the 2026 buildout scenario for both analysis periods. Given the 45-mph posted speed and higher traffic volumes, a northbound turn lane is recommended at this access.
12. Right-turn lane warrants are not met at either proposed site access intersection on SW Norwood Road for either peak hour under the 2026 buildout scenario for any analysis period. The warrant is initially met at the site access opposite SW 89th Avenue at SW Norwood Road under 2024 Buildout conditions; however, the lane is not needed once the site access at SW Boones Ferry Road is opened. Therefore, no right-turn lane is recommended.



13. Traffic signal warrants are not met at any unsignalized intersection in the study area under either buildout scenario for any analysis period.
14. Three intersections show operational results that do not meet standards under at least one scenario:
 - o The intersection of SW Boones Ferry Road at SW Avery Street is expected to operate acceptably under all scenarios except the 2026 Buildout conditions without the Basalt Creek Parkway extension. Based on the operational analysis, which shows that construction of the Basalt Creek Parkway Extension is expected to result in improved operations, and the conservatively high estimates of forecast growth, no mitigation is recommended at this intersection.
 - o The intersection of SW Boones Ferry Road at SW Iowa Drive is expected to operate with LOS F conditions under all scenarios and demand is expected to exceed capacity under 2026 Buildout conditions during the morning peak hour. Since signal warrants are not met and field observations show that delays are lower because the eastbound approach operates with a separate right-turn lane during congested conditions, no mitigation is recommended. However, the City could consider striping separate left- and right-turn lanes on the eastbound approach to formalize the lane configuration.
 - o The intersection of the I-5 Southbound Off-Ramp at SW Elligsen Road is expected to operate with a v/c ratio that exceeds the OHP mobility target of 0.85 for freeway ramps for the morning peak hour for the existing condition and all subsequent scenarios. The 2018 RTP includes Project 11489 in the financially-constrained list, which would construct a second right-turn lane on the exit ramp. With this improvement, the ramps would operate well below the 0.85 mobility target. Although the RTP project acknowledges that conditions are currently congested, the time period for the improvement is identified as 2028-2040. Since the planned improvements for the interchange are part of the financially-constrained RTP and the contributing volumes and impact of the proposed development is relatively small, no project mitigation is recommended for this intersection.
15. All other study area intersections are projected to operate acceptably per each applicable performance standard under all analysis scenarios; no other mitigation is recommended.
16. Storage recommendations for the site access intersection at SW Boones Ferry Road include:
 - o Maximum queues were estimated at two vehicles or 50 feet for the southbound left, which can easily be accommodated in the existing center refuge lane. The recommended striping for the southbound left-turn lane should include 100 feet of storage and the appropriate deceleration for the 45-mph posted speed.
 - o The northbound left will rarely have a queue since frontage road to the west will only serve a few homes. This lane is recommended to be striped as a two-way, left-turn lane to allow for a two-stage westbound left-turn movement from the site access.
 - o Maximum queues were estimated at six vehicles or 150 feet for the westbound left-movement with a two-lane approach for the site access. These queues will not affect the closest public street connection ("M" Street) to the east.

Project Description

Introduction

The proposed Autumn Sunrise Subdivision includes the development of 400 residential lots on a site located south of SW Norwood Road, west of Interstate 5, north of SW Greenhill Lane, and east of SW Boones Ferry Road in Tualatin, Oregon. Although the site also includes two lots zoned for neighborhood commercial use, this report does not incorporate the impacts of the future commercial development on those lots. In coordination with agency staff, a separate land use application and traffic study will be prepared at the time that development of those lots is proposed. The site will initially take all access from SW Norwood Road but includes a connection to SW Boones Ferry Road will be added with later phases. A site plan is provided in Appendix A.

The purpose of this study is to determine whether the transportation system within the vicinity of the site is capable of safely and efficiently supporting the proposed development and to determine any mitigation that may be necessary to do so.

Based on prior scoping coordination with the City of Tualatin, Washington County, and ODOT, the report includes safety and capacity analyses at 15 intersections:

1. SW Boones Ferry Road & SW Sagert Street
2. SW Boones Ferry Road & SW Avery Street
3. SW Boones Ferry Road & SW Ibach Street
4. SW Boones Ferry Road & SW Iowa Drive
5. SW Boones Ferry Road & SW Norwood Road
6. SW Boones Ferry Road & Site Access
7. SW Boones Ferry Road & SW Greenhill Lane
8. SW Boones Ferry Road & SW Day Road
9. SW Boones Ferry Road & SW 95th Avenue
10. I-5 Southbound Ramps & SW Elligsen Road
11. I-5 Northbound Ramps & SW Elligsen Road
12. Site Access/SW 89th Avenue & SW Norwood Road
13. Site Access/SW Vermillion Drive & SW Norwood Road
14. SW 82nd Avenue & SW Norwood Road
15. SW 65th Avenue & SW Norwood Road

Detailed information on traffic counts, trip generation calculations, safety analyses, and level of service calculations are included in the appendix to this report.

Location Description

The project site (Tax Lots 2S135D 100, 400, 401, 500, 501, 600, 800, & 900) is approximately 61.99 acres and is zoned medium low density residential. The surrounding land uses are compatible to the proposed project, consisting of predominately residential neighborhoods and schools that serve the residents. Future access to the site will be provided via three new, proposed driveways:

- A full access driveway directly across SW Norwood Road from the SW 89th Avenue intersection
- A full access driveway directly across SW Norwood Road from the SW Vermillion Drive intersection
- A full access driveway along SW Boones Ferry Road across from a future frontage road connection

A site plan is included in Appendix A and the site location is shown in Figure 1.

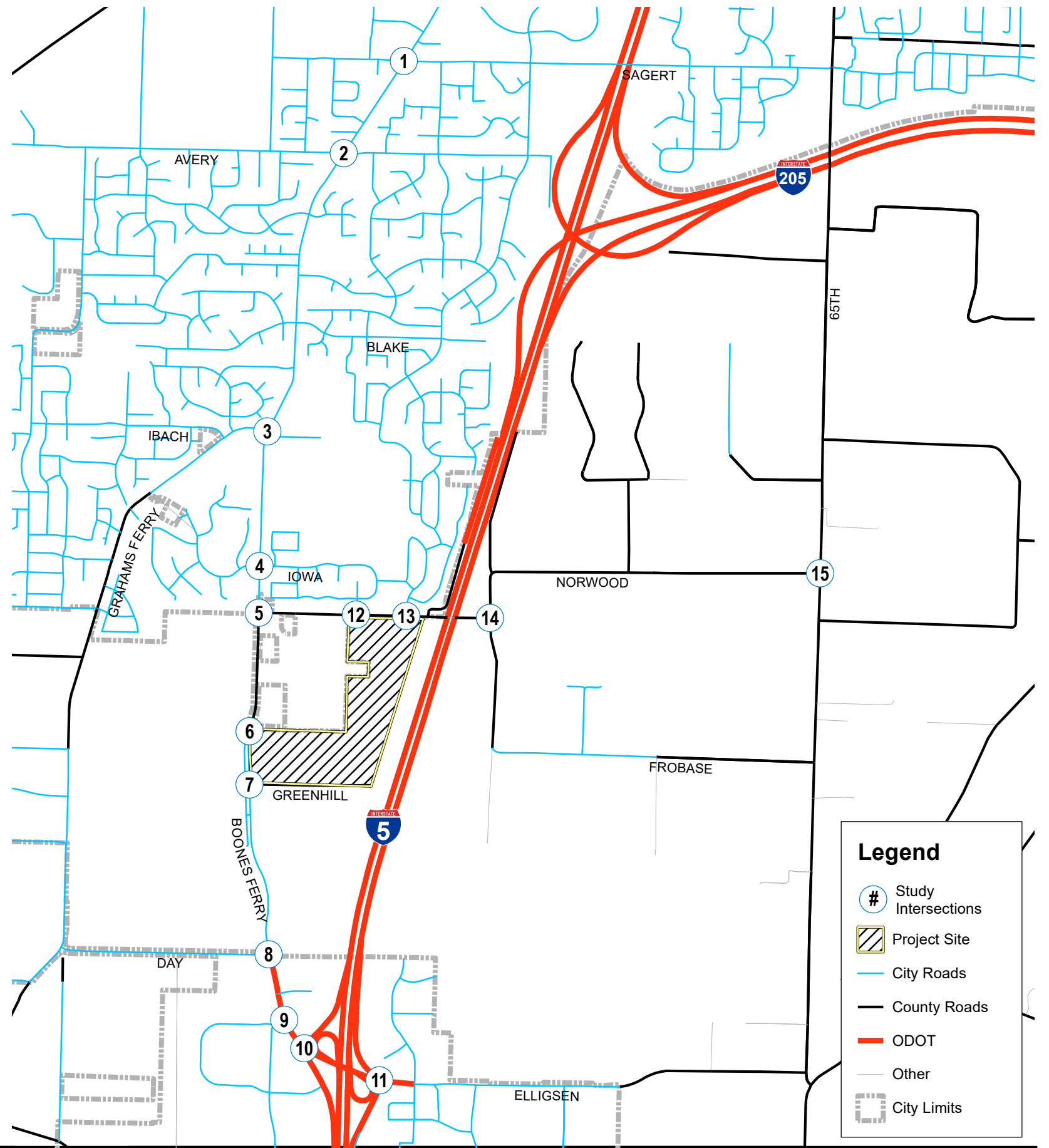
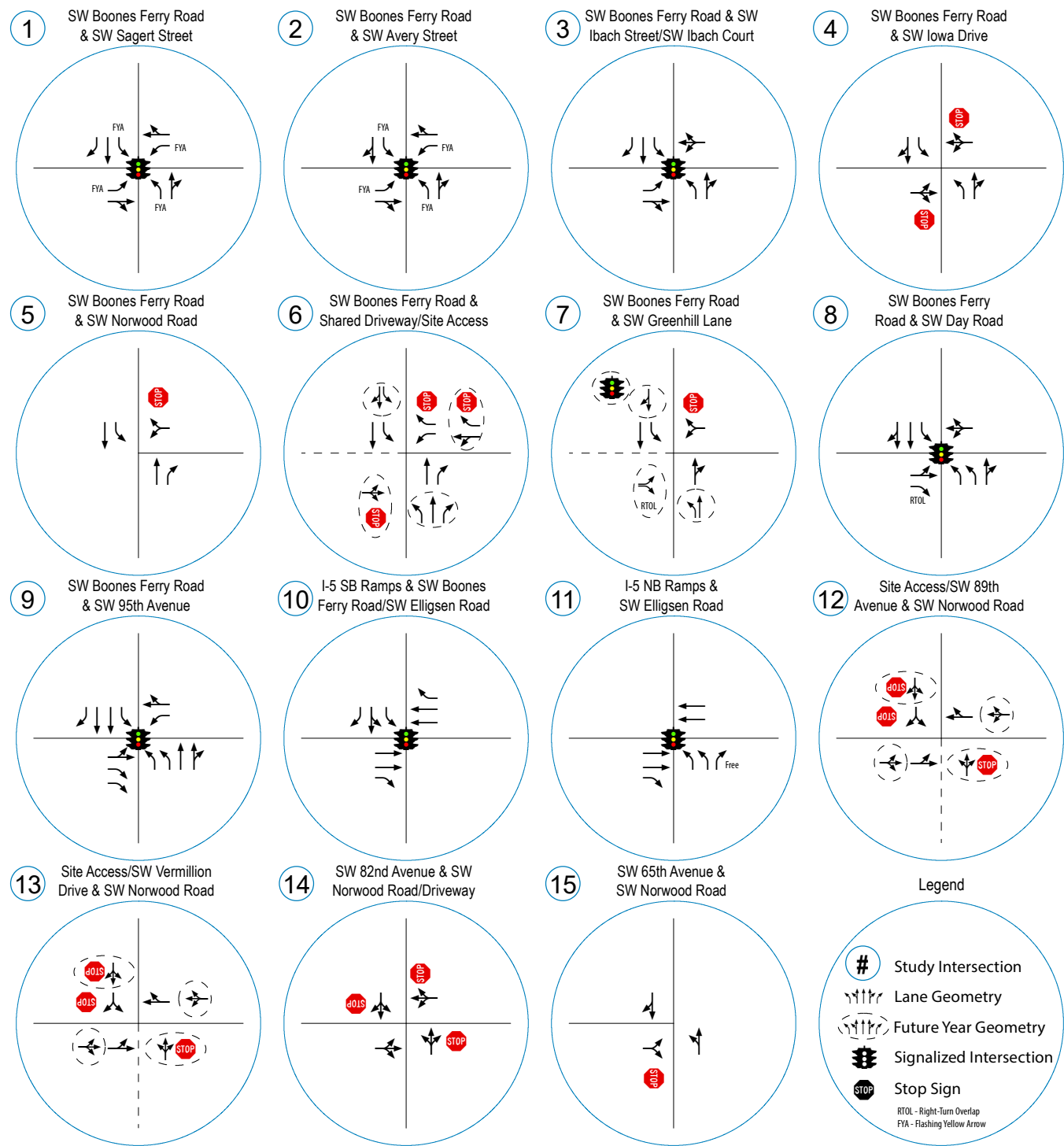

Vicinity Streets

Thirteen roadways within the study area are expected to be impacted by the proposed development. The characteristics of these roadways are summarized in Table 1.

Table 1: Roadway Characteristics

Street Name	Jurisdiction	Functional Classification	Posted Speed	Curbs & Sidewalks	On-Street Parking	Bicycle Facilities
SW Boones Ferry Road	City of Tualatin / Washington County / ODOT	Major Arterial / Arterial / District Highway	35 / 45 / 35 mph	Both Sides (Sidewalks Added with Project)	None	Class II Bike Lanes
SW 89 th Avenue	City of Tualatin	Local	25 mph ¹	Both Sides	Permitted	None
SW Vermillion Drive	City of Tualatin	Local	25 mph	Both Sides	Permitted	None
SW 82 nd Avenue	Washington County	Major Collector	45 mph	None	None	None
SW 65 th Avenue	Washington County	Arterial	45 mph	None	None	None
SW Sagert Street	City of Tualatin	Minor / Major Collector	25 / 30 mph	Partial Both Sides	None	Class II Bike Lanes
SW Avery Street	City of Tualatin	Major / Minor Collector	35 / 25 mph	Both Sides	None	Class II Bike Lanes
SW Ibach Street / Court	City of Tualatin	Major Collector / Local	35 / 25 mph	Both Sides	None	Class II Bike Lanes
SW Iowa Drive	City of Tualatin	Minor Collector	25 mph	Both Sides	None	None
SW Norwood Road	Washington County	Collector (Major Collector ²)	45 mph	Both Sides	None	None
SW Day Road	City of Wilsonville	Major Arterial	40 mph	South Side	None	Class II Bike Lanes
SW Elligsen Road	ODOT	District Highway (Major Arterial ³)	35 mph	Both Sides	None	Class II Bike Lanes
SW 95 th Avenue	City of Wilsonville	Minor Arterial	35 mph	Both Sides	None	Class II Bike Lanes

Notes:

1. Statutory speed.
2. City of Tualatin Classification.
3. City of Wilsonville Classification.

Study Intersections

Through coordination with the City of Tualatin, Washington County, and ODOT, fifteen (15) study intersections were identified for evaluation. The existing characteristics of these intersections are summarized in Table 2. A vicinity map showing the project site, vicinity streets, and study intersection configurations is shown in Figure 1.

Table 2: Vicinity Intersection Descriptions

	Intersection	Geometry	Traffic Control	Phasing/Stopped Approaches
1	SW Boones Ferry Road & SW Sagert Street	Four-Legs	Signalized	All Protected/ Permitted Left
2	SW Boones Ferry Road & SW Avery Street	Four-Legs	Signalized	All Protected/ Permitted Left
3	SW Boones Ferry Road & SW Ibach Street/SW Ibach Court	Four-Legs	Signalized	Protected NB/SB Left
4	SW Boones Ferry Road & SW Iowa Drive	Four-Legs	Stop-Controlled	WB/EB Stop-Controlled
5	SW Boones Ferry Road & SW Norwood Road	Three-Legs	Stop-Controlled	WB Stop-Controlled
6	SW Boones Ferry Road & Site Access (Future)	Three-Legs	Stop-Controlled	WB Stop-Controlled
7	SW Boones Ferry Road & SW Greenhill Lane	Three-Legs	Stop-Controlled	WB Stop-Controlled
8	SW Boones Ferry & SW Day Road	Four-Legs	Signalized	Protected NB/SB Left Right Turn Overlap
9	SW Boones Ferry & SW 95 th Avenue	Four-Legs	Signalized	NB/SB Protected Left EB Right Turn Overlap
10	I-5 Southbound Off-Ramp & SW Elligsen Road	Four-Legs	Signalized	Partial SB Right Turn Overlap with EB Through EB/WB Right Yield Controlled
11	I-5 Northbound Off-Ramp & SW Elligsen Road	Four-Legs	Signalized	EB/NB Right Yield Controlled
12	SW 89th Avenue/Site Access (Future) & SW Norwood Road	Three-Legs ¹	Stop-Controlled	SB Stop-Controlled
13	SW Vermillion Drive/Site Access (Future) & SW Norwood Road	Three-Legs ¹	Stop-Controlled	SB Stop-Controlled
14	SW 82nd Avenue & SW Norwood Road	Four-Legs	Stop-Controlled	NB/SB Stop-Controlled Except SB Free Right
15	SW 65th Avenue & SW Norwood Road	Three-Legs	Stop-Controlled	EB Stop-Controlled

Note

1. The southern leg of intersections 12 and 13 will be constructed by the project and will be stop controlled.

Public Transit

The project is located near one transit line that has stops within an approximate one-half mile walking/biking distance of the site.

Route 96 – Tualatin/I-5 provides weekday rush-hour service between Commerce Circle and the Mohawk Park & Ride in Tualatin, and regular service between Mohawk Park & Ride and Portland City Center. Weekday service is scheduled from approximately 5:15 AM to 9:10 PM with headways of approximately 30 to 60 minutes. There is currently no weekend or holiday service. The nearest bus stops to the site are currently located at:

- SW Boones Ferry Road and SW Norwood Road
- SW Boones Ferry Road and SW Greenhill Lane

Trimet might consider adding another stop at the proposed site access on SW Boones Ferry Road to serve the proposed development.

Site Trips

The proposed development includes the construction of 320 detached home lots and 80 attached home lots. A supplemental memorandum addressing potential development of the commercial parcels abutting SW Boones Ferry Road is included in Appendix E. This memorandum includes trip generation for several potential commercial development scenarios of different intensities.

Trip Generation

To estimate trips that will be generated by the redevelopment, trip equations from the *Trip Generation Manual*¹ were used based on the number of dwelling units (DU). Land Use 210 – *Single-Family Detach Housing* was applied to the 320 detached units in the site while Land Use 220 – *Multifamily Housing (Low-Rise)* was applied to the 80 attached units.

As shown in Table 3, the trip generation calculations show that the proposed Autumn Sunrise Subdivision is estimated to generate 271 trips during the morning peak hour, 358 trips during the evening peak hour, and 3,596 daily trips during the average weekday.

Table 3: Trip Generation Summary

ITE Code	Intensity (DU)	Morning Peak Hour			Evening Peak Hour			Daily Trips
		In	Out	Total	In	Out	Total	
Single-Family Detached Housing	320	58	174	232	195	115	310	3,032
Multifamily Housing (Low-Rise)	80	9	30	39	30	18	48	564
Total	400	67	204	271	225	133	358	3,596

Note: Trip equations were applied for these land uses.

Table 4 presents the number and type of housing units and the trip generation by phase of development. With Phases 1 and 2, all site access will be taken from SW Norwood Road. The site access to SW Boones Ferry Road will be constructed with the completion of Phase 3. Phase 1 is expected to be constructed in year 2023 with each phase completed the subsequent year. Full buildout would occur in year 2026.

¹ Institute of Transportation Engineers (ITE), *Trip Generation Manual*, 10th Edition, 2017.

Table 4: Trip Generation by Phase

Phase	Intensity (DU)			Morning Peak Hour			Evening Peak Hour			Daily Trips
	Single	Multi	Total	In	Out	Total	In	Out	Total	
1	85	24	109 (27%)	18	55	73	61	36	97	975
2	41	14	55 (14%)	9	28	37	30	18	48	487
3	91	42	133 (33%)	21	65	86	71	42	113	1,158
4	103	0	103 (26%)	19	56	75	63	37	100	976
<i>Subtotal (1-2)</i>	<i>126</i>	<i>38</i>	<i>164 (41%)</i>	<i>27</i>	<i>83</i>	<i>110</i>	<i>91</i>	<i>54</i>	<i>145</i>	<i>1,462</i>
<i>Subtotal (1-3)</i>	<i>217</i>	<i>80</i>	<i>297 (74%)</i>	<i>48</i>	<i>148</i>	<i>196</i>	<i>162</i>	<i>96</i>	<i>258</i>	<i>2,620</i>
Total (1-4)	320	80	400	67	204	271	225	133	358	3,596



Trip Distribution

The directional distribution of site trips to/from the project site is necessary to identify intersections to be included in the study area of the TIA. A select zone analysis using Metro's Regional Travel Demand Forecasting Model for the base year and future year were conducted for the site's Transportation Analysis Zone (TAZ). The trip distribution in this memorandum reports general consistency with the findings from the model.

- Approximately 40 percent of site trips will travel to/from the north on SW Boones Ferry Road
 - Approximately 3 percent of site trips will travel to/from Tualatin High School
 - Approximately 5 percent of site trips will travel to/from the west along SW Ibach Street
 - Approximately 2 percent of site trips will travel to/from northern neighborhoods
 - Approximately 10 percent of site trips will travel to/from the west along SW Avery Street
 - Approximately 10 percent of site trips will travel to/from the east along SW Sagert Street
 - Approximately 10 percent of site trips will continue to/from the north along SW Boones Ferry Road
- Approximately 45 percent of site trips will travel to/from the south on SW Boones Ferry Road
 - Approximately 10 percent will travel to/from west on SW Day Road
 - Approximately 15 percent will travel to/from north on Interstate 5
 - Approximately 10 percent will travel to/from south on Interstate 5
 - Approximately 10 percent will travel to/from east on SW Elligsen Road
- Approximately 15 percent of site trips will travel to/from the east on SW Norwood Road
 - Approximately 10 percent will travel to/from the north on SW 65th Avenue
 - Approximately 5 percent will travel to/from the south on SW 65th Avenue

Basalt Creek Parkway extension

Washington County is currently engineering the extension of the Basalt Creek Parkway eastward from SW Grahams Ferry Road to SW Boones Ferry Road at a connection just south of SW Greenhill Lane. Both city and county staff requested an analysis of the study area without and with the extension. The following changes in trip distribution with the Basalt Creek Parkway extension anticipated are:

- Shift seven (7) percent of project trips heading north on SW Boones Ferry Road (continuing onto SW Ibach Street and SW Avery Street) to the Basalt Creek Parkway extension.
- Shift eight (8) percent of project trips heading south on SW Boones Ferry Road (continuing onto SW Day Road) to the Basalt Creek Parkway extension.

These changes are not anticipated to change the project study area. The anticipated project trip distribution and assignment of site trips generated during the morning and evening peak hours without and with the Basalt Creek Parkway extension are provided in Figure 2A and B, respectively.

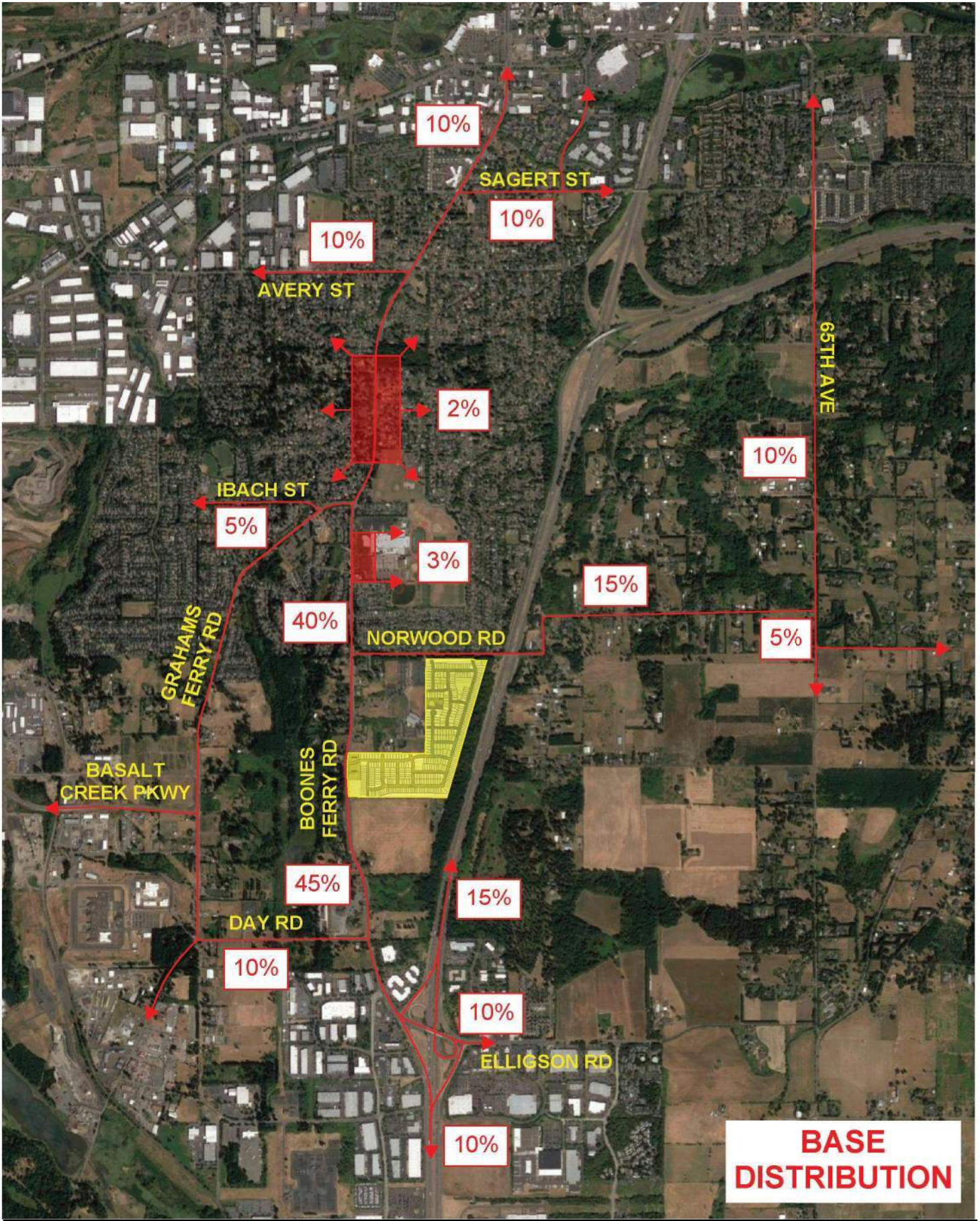

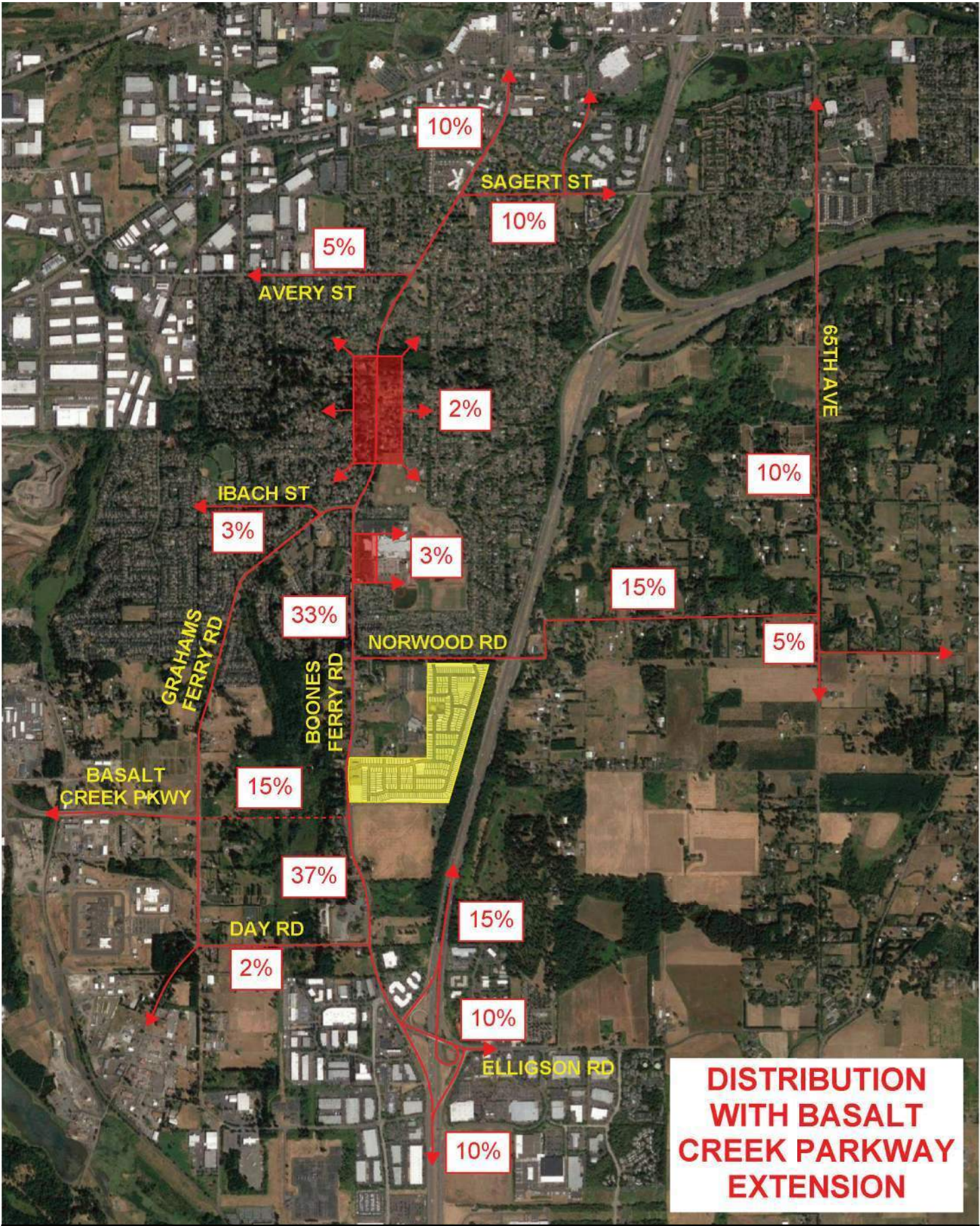

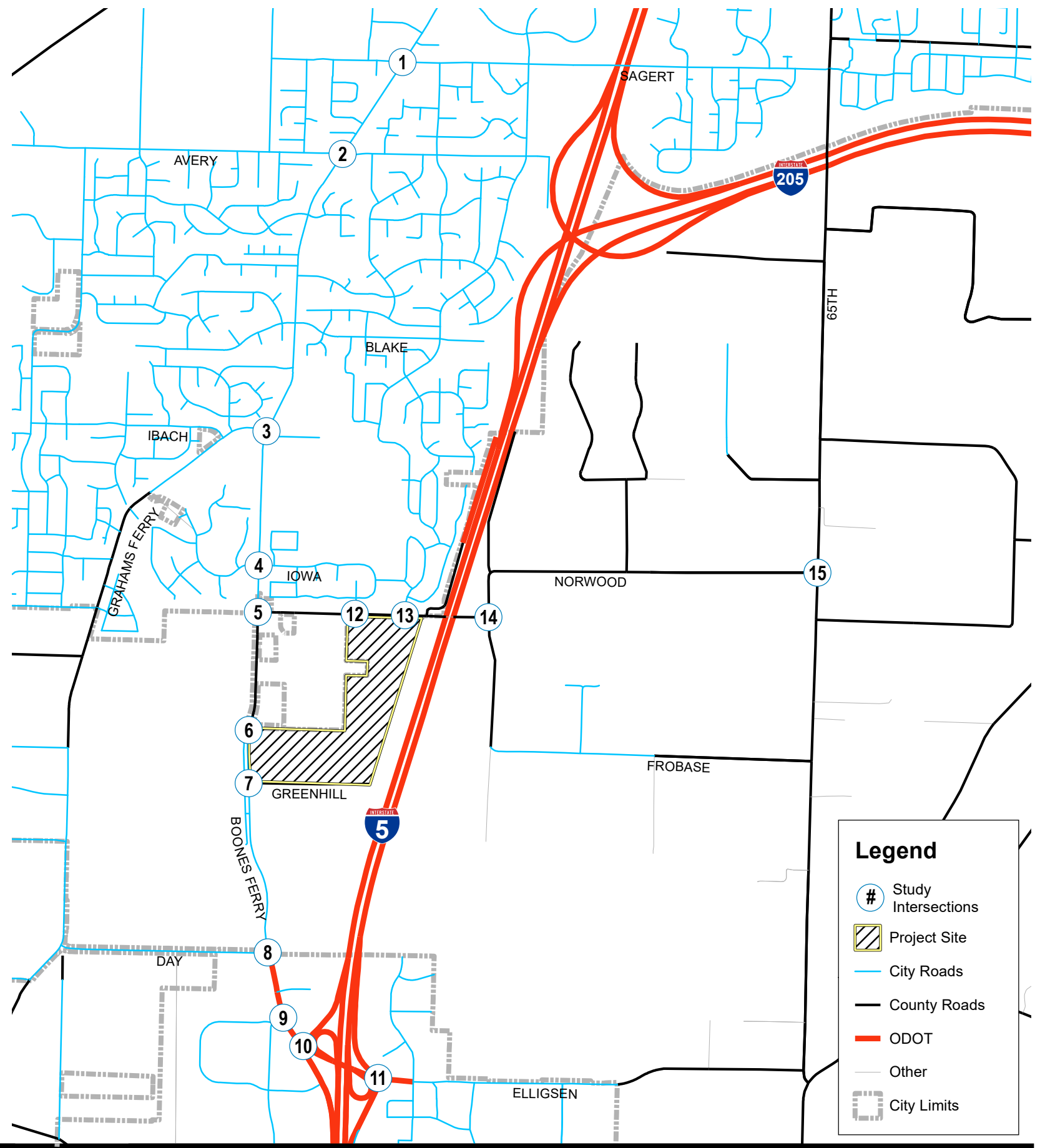
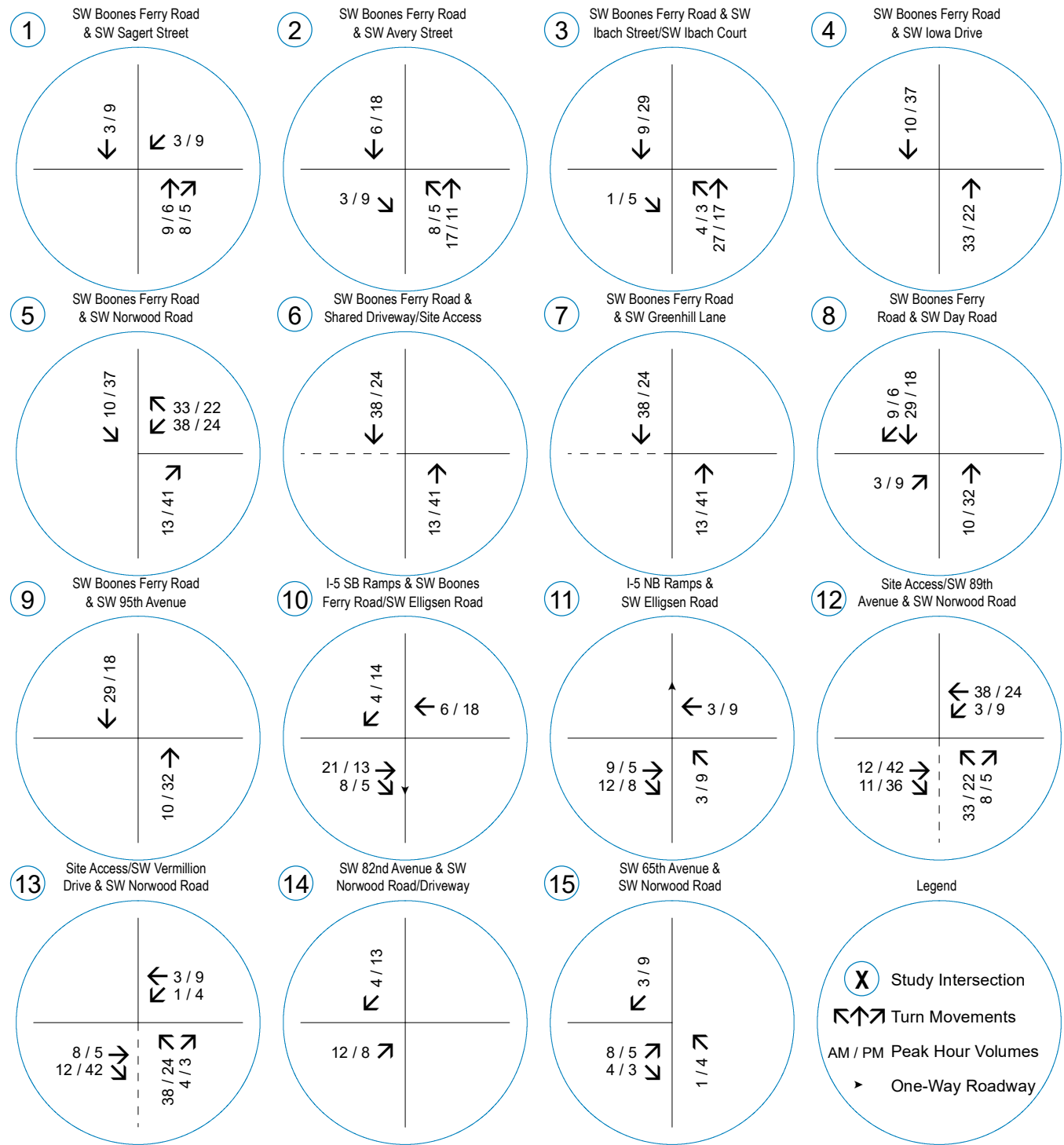

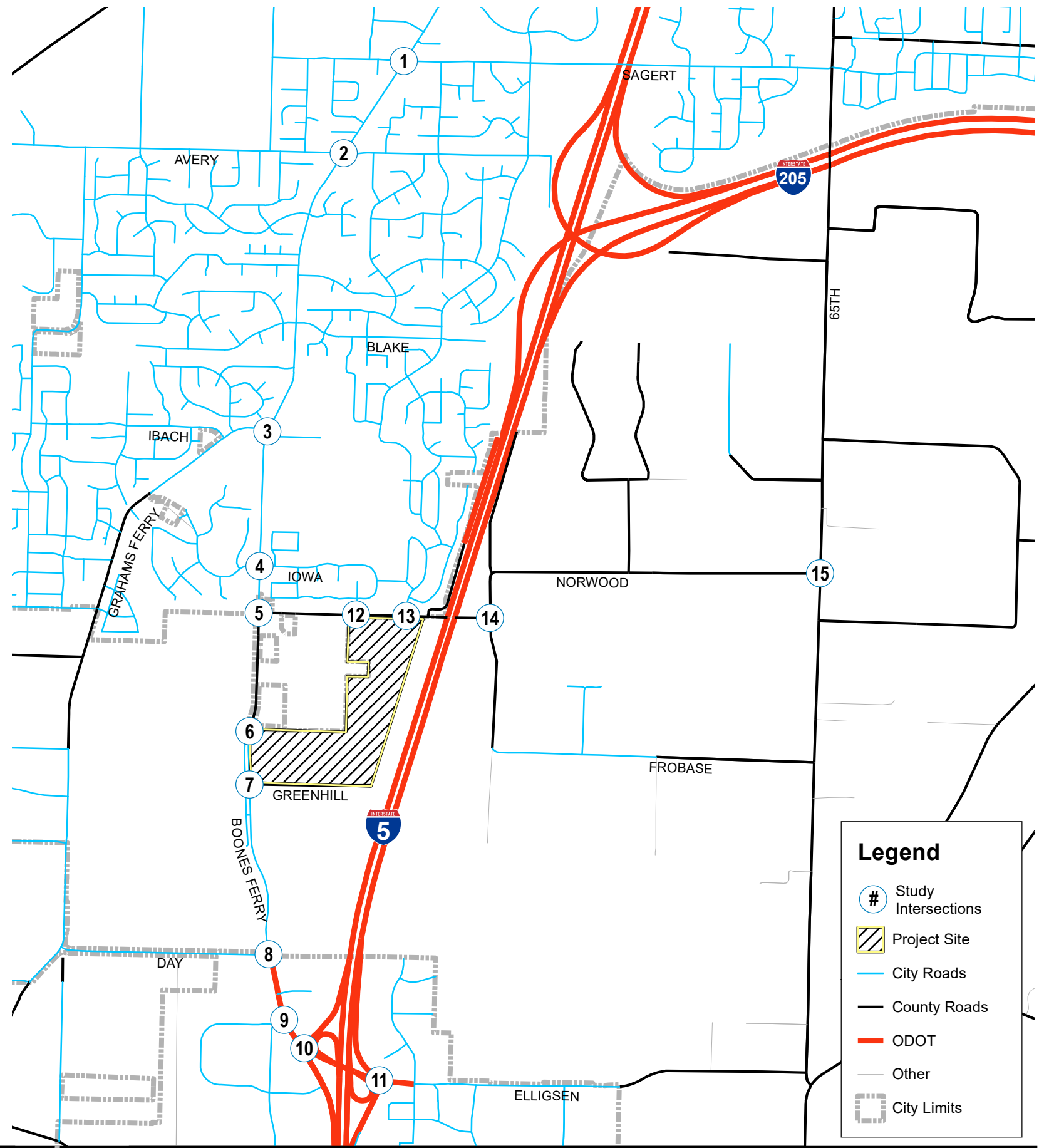
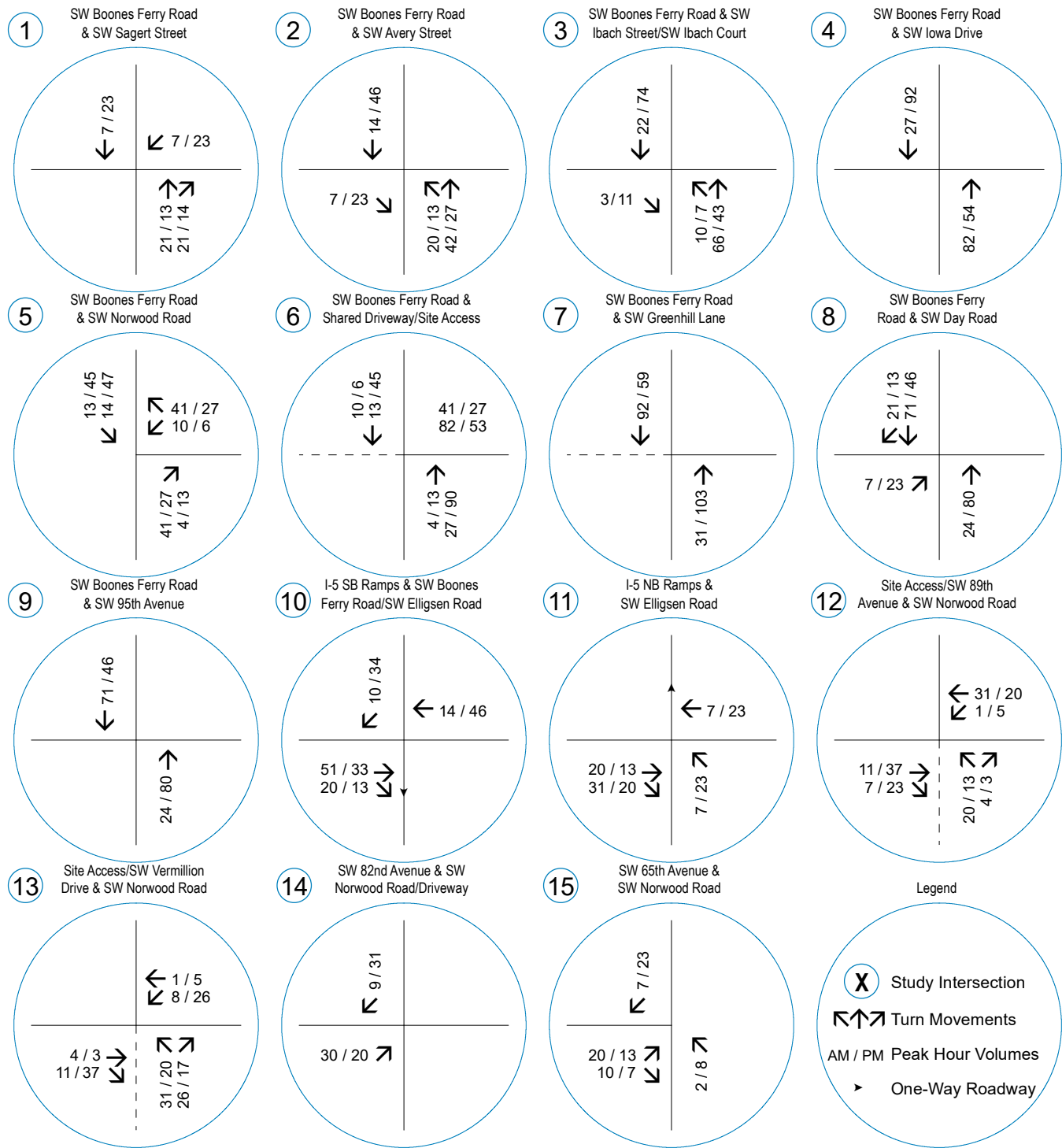

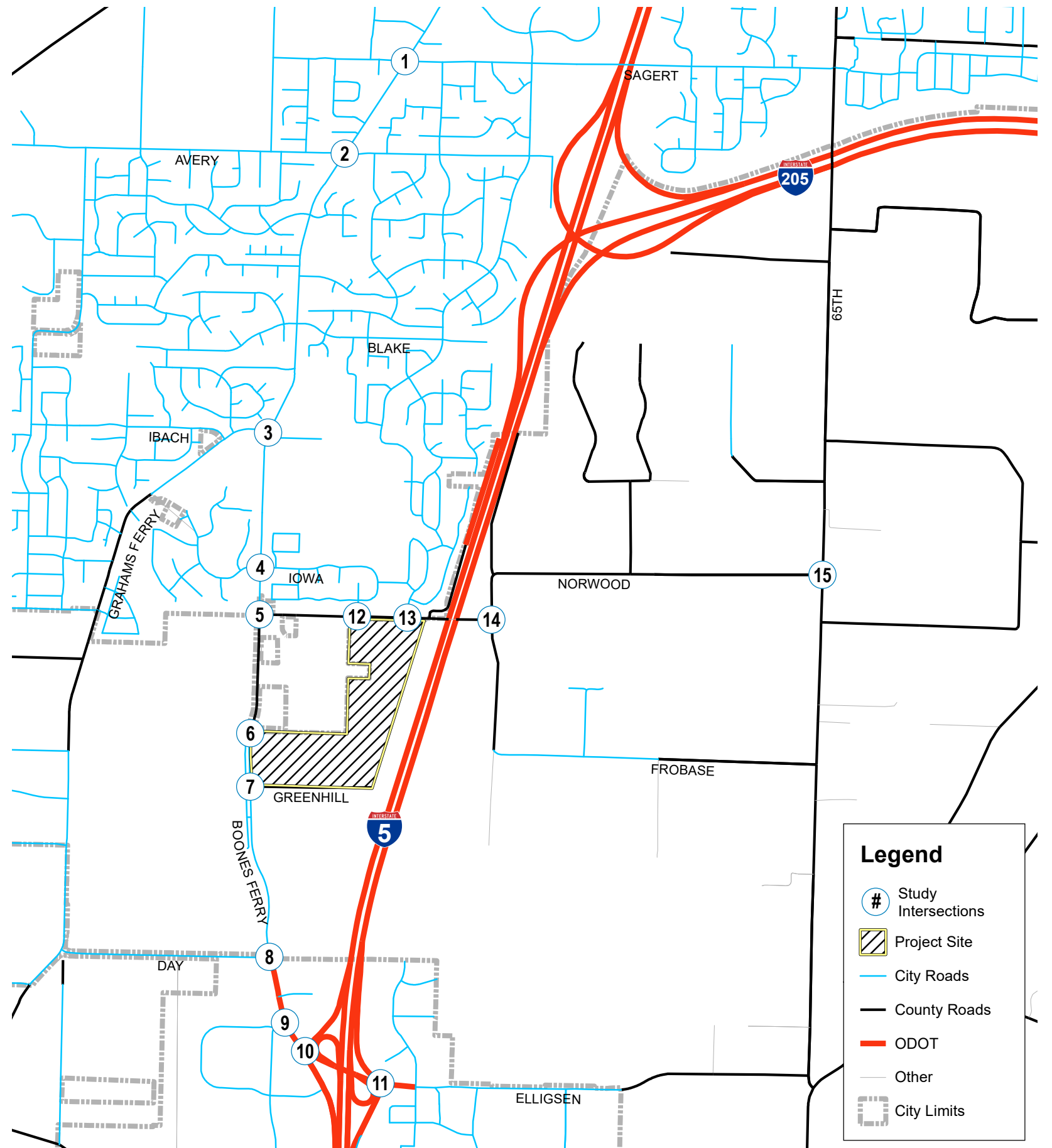
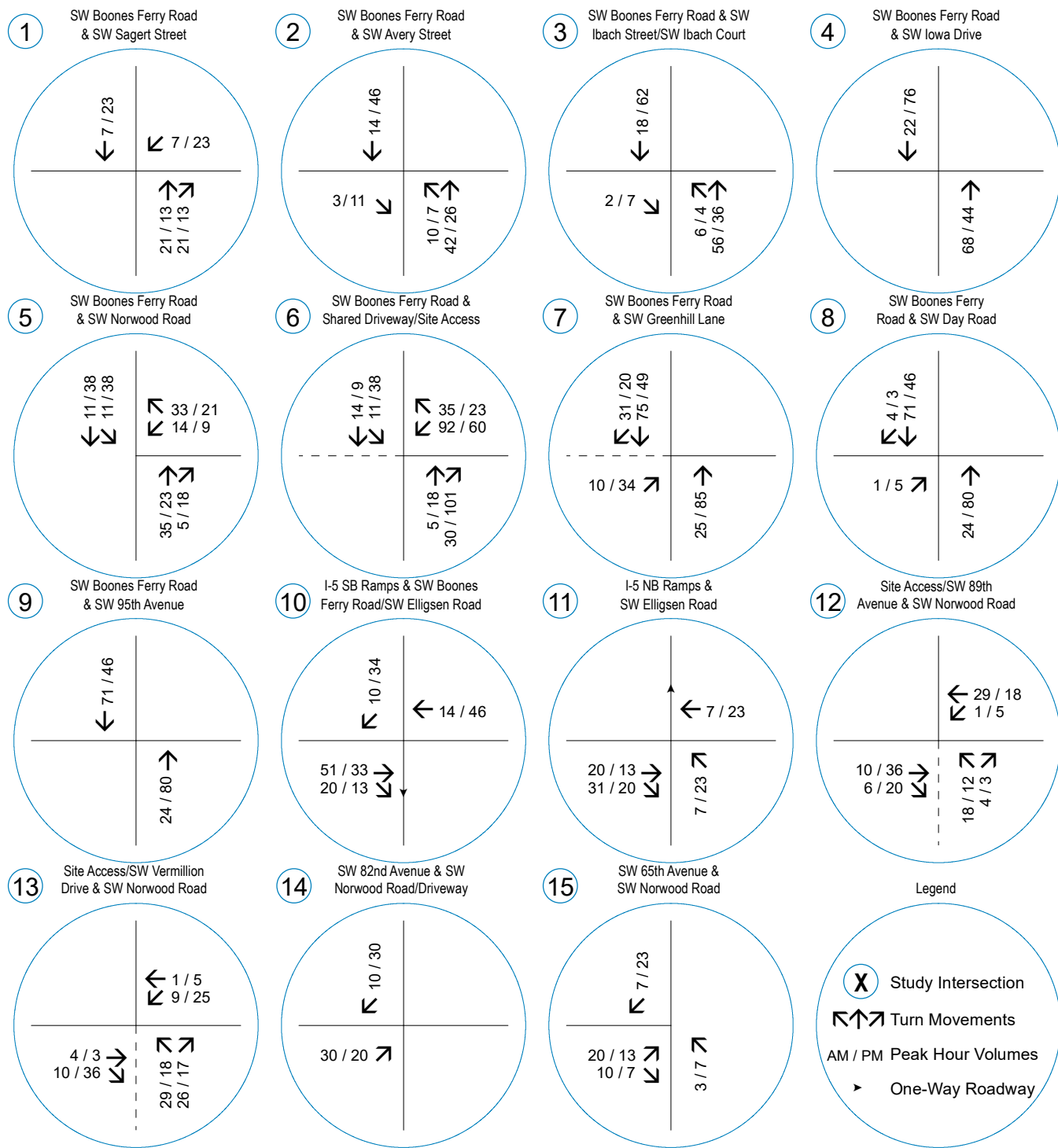

Traffic Volumes

Existing Conditions

The COVID-19 pandemic initiated a significant decrease in traffic due to policies on social distancing that have closed or limited business operations, reduced commuting as many people work from home, and shifted schools to distance learning. Data collection under these altered conditions does not reflect normal volumes on the study area roadways. Historical traffic data was available at some locations, but many of the study area intersections did not have counts in the past five years or were not reflective of the current roadway network. Therefore, a combination of current counts and historical traffic counts were used to approximate year 2021 existing conditions. Agency staff from City of Tualatin, Washington County, and ODOT approved the general methodology for adjusting counts during the scoping of this project; the specific dates and adjustments are presented in Table 5.

Table 5: Year 2021 Existing Condition Traffic Volume Development

Intersection		Count Date	Adjustment Methodology
1	SW Boones Ferry Road & SW Sagert Street	5/6/2021	<ul style="list-style-type: none"> AM/PM adjustment factors of 1.345/1.125 derived from historical link count on SW Boones Ferry Road Volumes balanced with adjacent intersection to south
2	SW Boones Ferry Road & SW Avery Street	10/29/2019	<ul style="list-style-type: none"> Historical count grown by 2%
3	SW Boones Ferry Road & SW Ibach Street	4/27/2017	<ul style="list-style-type: none"> Historical count grown by 4% Volumes balanced with adjacent intersection to north
4	SW Boones Ferry Road & SW Iowa Drive	9/29/2020	<ul style="list-style-type: none"> AM/PM adjustment factors from SW Norwood Road applied to intersection Volumes balanced with adjacent intersection to south
5	SW Boones Ferry Road & SW Norwood Road	9/29/2020	<ul style="list-style-type: none"> AM adjustment factor of 1.827 derived from historical link counts grown at 2%/year to year 2021 on SW Boones Ferry Road and SW Norwood Road PM adjustment factor of 1.071 derived from historical turning movement count grown at 2%/year to year 2021
6	SW Boones Ferry Road & Site Access (Future)	-	<ul style="list-style-type: none"> Through volumes balanced with adjacent intersection to north
7	SW Boones Ferry Road & SW Greenhill Lane	-	<ul style="list-style-type: none"> Through volumes balanced with adjacent intersection to north Turning movements from ITE rates for residences on SW Greenhill Lane

Table 5: Year 2021 Existing Condition Traffic Volume Development

Intersection		Count Date	Adjustment Methodology
8	SW Boones Ferry & SW Day Road	3/30/2021	<ul style="list-style-type: none"> AM/PM adjustment factors of 1.489/1.326 for south leg derived from historical count on SW Boones Ferry Road to south grown at 2%/year to year 2021 Turning movements on west and east legs balanced with adjacent intersection to north
9	SW Boones Ferry & SW 95 th Avenue	6/8/2021	<ul style="list-style-type: none"> AM/PM adjustment factors of 1.214/1.117 derived from historical counts on SW Boones Ferry Road grown at 2%/year to year 2021 Volumes balanced with adjacent intersection to south
10	I-5 Southbound Off-Ramp & SW Elligsen Road	9/29/2020	<ul style="list-style-type: none"> AM/PM adjustment factors of 1.241/1.070 derived from historical link counts on SW Boones Ferry Road and interchange ramps grown at 2%/year to year 2021 Volumes balanced with adjacent intersection to west & east
11	I-5 Northbound Off-Ramp & SW Elligsen Road	9/29/2020	<ul style="list-style-type: none"> AM/PM adjustment factors of 1.241/1.070 derived from historical link counts on SW Boones Ferry Road and interchange ramps grown at 2%/year to year 2021 Volumes balanced with adjacent intersection to west
12	SW 89th Avenue & SW Norwood Road	9/29/2020	<ul style="list-style-type: none"> AM/PM adjustment factors of 1.876/1.596 derived from historical link counts on SW Norwood Road at 2%/year to year 2021
13	SW Vermillion Drive & SW Norwood Road	9/29/2020	<ul style="list-style-type: none"> AM/PM adjustment factors of 1.876/1.596 derived from historical link counts on SW Norwood Road east of SW Boones Ferry Road at 2%/year to year 2021 Volumes balanced with adjacent intersection to west
14	SW 82nd Avenue & SW Norwood Road	10/7/2020	<ul style="list-style-type: none"> AM/PM adjustment factors of 2.114/1.238 derived from historical link counts on SW Norwood Road east of SW 82nd Avenue at 2%/year to year 2021 Volumes balanced with adjacent intersection to west
15	SW 65th Avenue & SW Norwood Road	9/29/2020	<ul style="list-style-type: none"> AM/PM adjustment factors of 2.588/1.566 derived from historical turning movement count at intersection at 2%/year to year 2021

One notable trend about the adjustment factors is that they are consistently greater during the morning peak hour than the evening peak hour. The morning volumes appear to be much lower than historical traffic due to the pandemic’s impacts on both commuting and school. The differences were generally greater at the intersections closer to Tualatin High School and lesser at the intersections further away.

Another notable trend was that peak hour factors for the data collected during the pandemic were lower than many of the historical factors. This trend likely reflects less congestion on the area roadways and, consequently,



less peak traffic spreading over the hour. For the operations analysis, the higher peak hour factors were applied to the intersection volumes.

The resulting 2021 existing condition traffic volumes during the morning and evening peak hours are displayed in Figure 4.



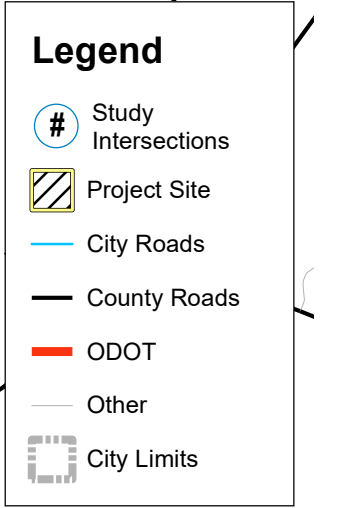
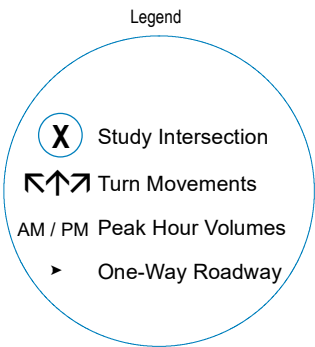
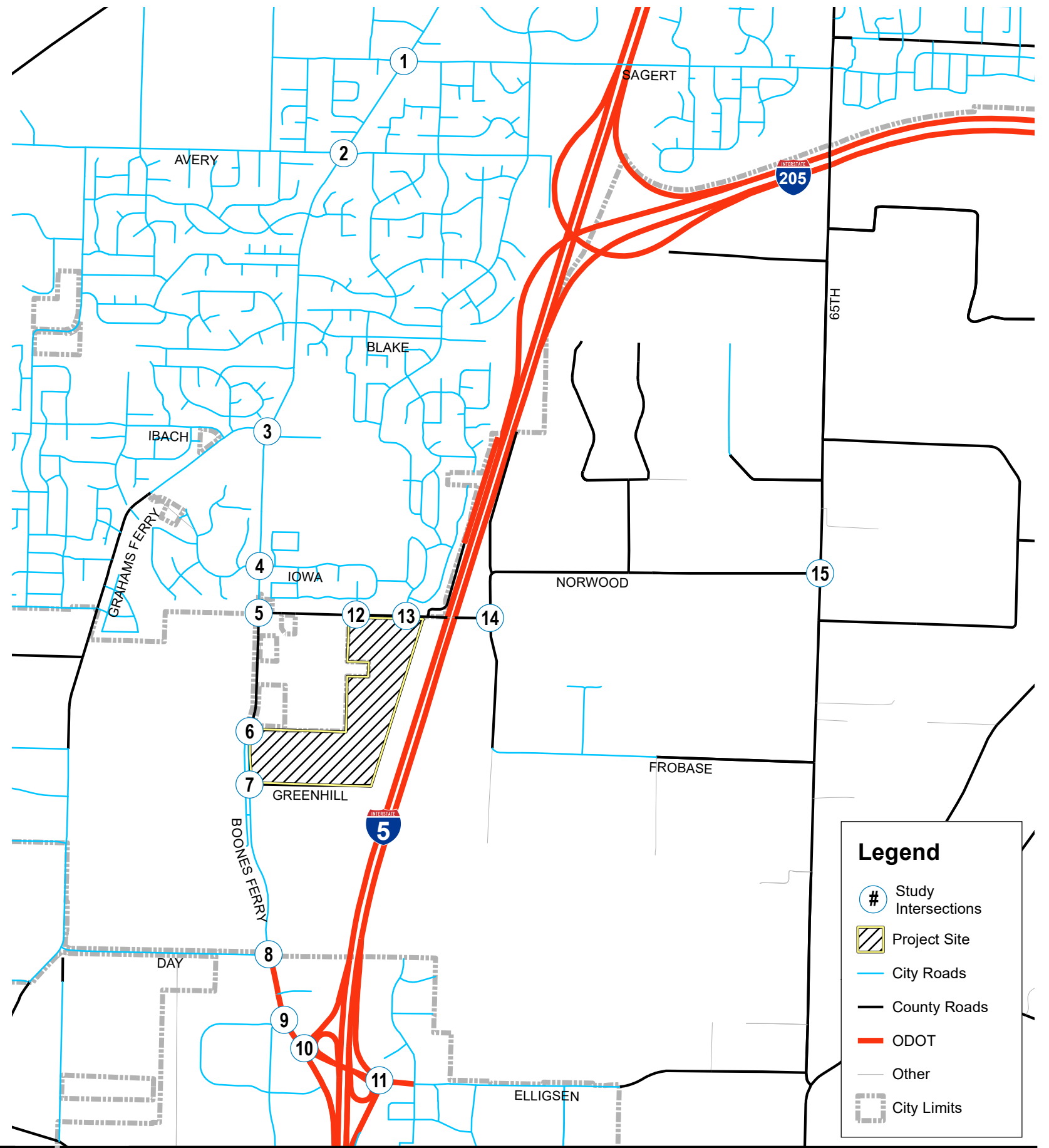
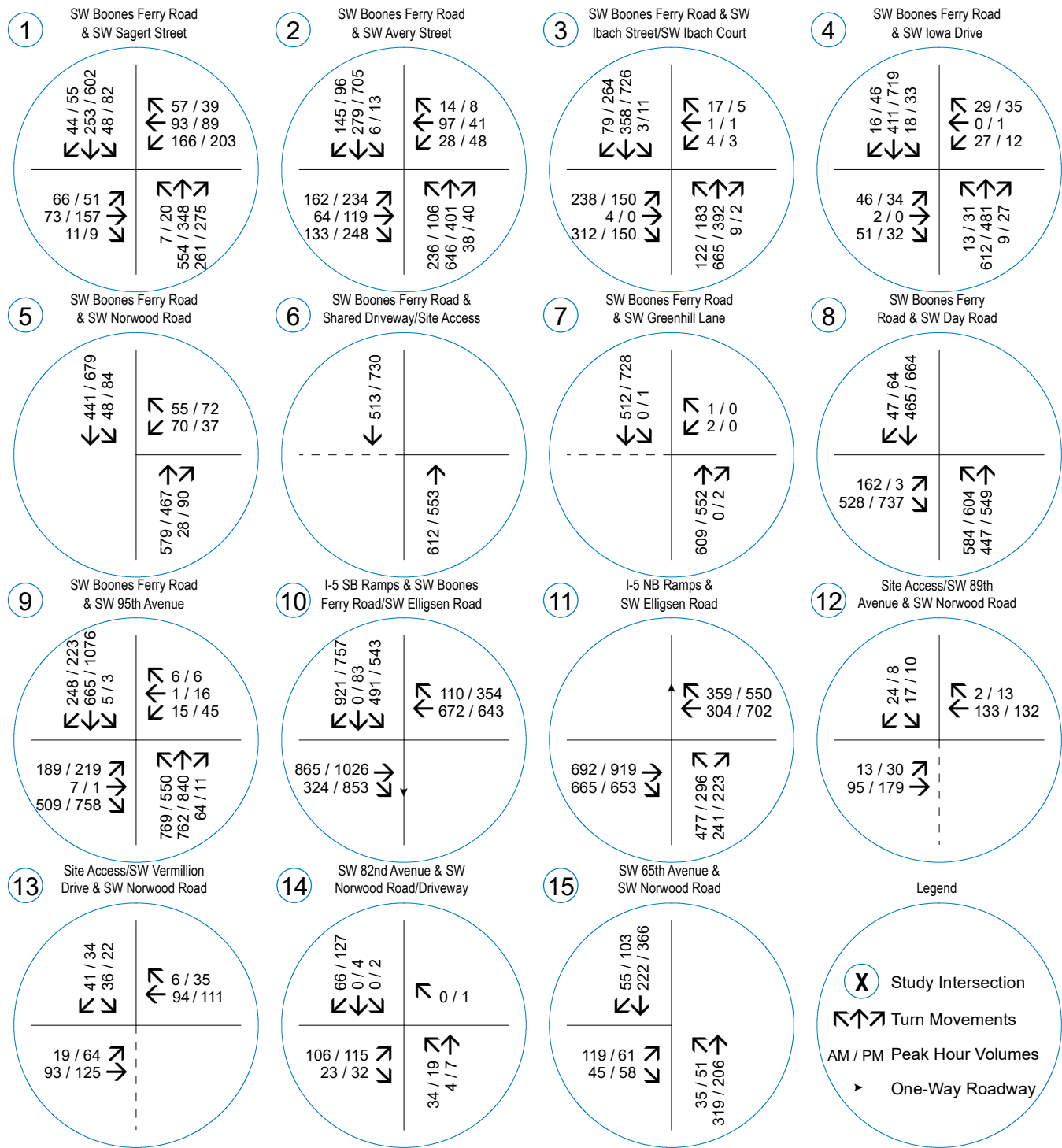

Background Conditions

To provide analysis of the impact of the proposed development on the nearby transportation facilities, an estimate of future traffic volumes is required. Two components were included in the background traffic estimates: 1) general growth and 2) growth associated with planned developments.

For the background growth, an annual growth rate of two percent per year was applied to the adjusted year 2021 existing traffic volumes. This growth rate is generally consistent with historical growth rates on study area roadways.

For planned development related growth, the Affordable Housing development known as Plambeck Gardens, is planned to be constructed to the north of the project site along SW Boones Ferry Road. The buildout year for this project was assumed to be 2025, which corresponds with the Phase 3 development year the proposed Autumn Sunrise project. Therefore, trip assignment associated with this nearby development was included in the 2026 background year scenario. Plambeck Gardens traffic was assumed to share the access on SW Boones Ferry Road with Autumn Sunrise. Detailed project trip information can be found in Appendix B.

Background Year 2024

Phases 1 and 2 of the proposed development are anticipated to be completed in the year 2024 with all site access taken from SW Norwood Road; the site access on SW Boones Ferry Road will not be constructed with these phases. Background traffic volumes were estimated to correspond with this interim access condition. Background Year 2024 conditions assume three years of growth. The year 2024 background traffic volumes are displayed in Figure 5A.

Background Year 2026

By the year 2026, all phases of the proposed development are anticipated to be completed with site access on both SW Norwood Road and SW Boones Ferry Road. Background traffic volumes were estimated to correspond with this full access condition. Background Year 2026 conditions assume five years of growth plus the planned Plambeck Gardens project. The year 2026 background traffic volumes are displayed in Figure 5B.

Background Year 2026 with Basalt Creek Parkway Extension

Washington County is currently engineering the extension of the Basalt Creek Parkway eastward from SW Grahams Ferry Road to SW Boones Ferry Road at a connection just south of SW Greenhill Lane. Construction is planned to begin in 2023 with completion anticipated in 2025 but is contingent on securing funding for the project.

Since funding and the construction timeline are indefinite, this project was not assumed as part of the base transportation network. However, an analysis scenario with the planned project has been developed to understand how it might change traffic operations with the proposed project. Short-term traffic volumes were not developed in the County study for this phase of the Basalt Creek Parkway project; therefore, several assumptions about traffic shifts were assumed to estimate study area traffic with completion of the extension:

- 50 percent of the northbound traffic currently turning left from SW Boones Ferry Road to SW Day Road will continue traveling northward and turn left on the Basalt Creek Parkway Extension.

- 50 percent of the eastbound traffic currently turning right from SW Day Road to SW Boones Ferry Road will travel along the Basalt Creek Parkway Extension and turn right on SW Boones Ferry Road at the new intersection.
- 80 percent of the southbound traffic currently turning right from SW Boones Ferry Road to SW Day Road will turn on the Basalt Creek Parkway Extension instead of continuing south to SW Day Road.
- 80 percent of the eastbound traffic currently turning left from SW Day Road to SW Boones Ferry Road will travel along the Basalt Creek Parkway Extension and turn left onto SW Boones Ferry Road at the new intersection.
- Traffic shifts from roadways north of SW Day Road are anticipated to be relatively small as most shifts from those roads likely occurred when earlier phases of the project were constructed. The earlier phases included the extension of SW 124th Avenue southward from SW Tualatin-Sherwood Road to SW Tonquin Road and the construction of the Basalt Creek Parkway connection between SW Tonquin Road and SW Grahams Ferry Road.
- The Basalt Creek Parkway Extension will disconnect the western north-south frontage road along the west side of at SW Boones Ferry Road from its current access point. The frontage road connection opposite the proposed Autumn Sunrise site access is assumed to be opened with the Basalt Creek Parkway Extension.

The year 2026 background traffic volumes with the Basalt Creek Parkway Extension are displayed in Figure 5C.

Buildout Conditions

Buildout traffic volumes were estimated by adding the trip assignment for the proposed development (shown in Figure 3A, Figure 3B, and Figure 3C) to the background traffic volumes.

Background Year 2024

Peak hour trips associated with Phases 1 and 2 were added to the projected year 2024 background volumes to obtain the expected 2024 buildout volumes. The resulting year 2024 buildout traffic volumes are shown in Figure 6A.

Buildout Year 2026

Peak hour trips associated with all development phases were added to the projected year 2026 background volumes obtain the expected 2026 buildout volumes. The year 2026 buildout traffic volumes are shown in Figure 6B.

Buildout Year 2026 with Basalt Creek Parkway Extension

The Basalt Creek Parkway Extension is expected to change traffic patterns for the project trips as well as background conditions. The peak hour trip assignment with the Basalt Creek Parkway extension were added to the projected year 2026 background volumes with the extension to obtain the expected 2026 buildout volumes with the extension. The year 2026 buildout traffic volumes with the Basalt Creek Parkway extension are shown in Figure 6C.

Traffic volumes for the site access at SW Boones Ferry Road with potential commercial development scenarios of different intensities are presented in a supplemental memorandum included in Appendix E.

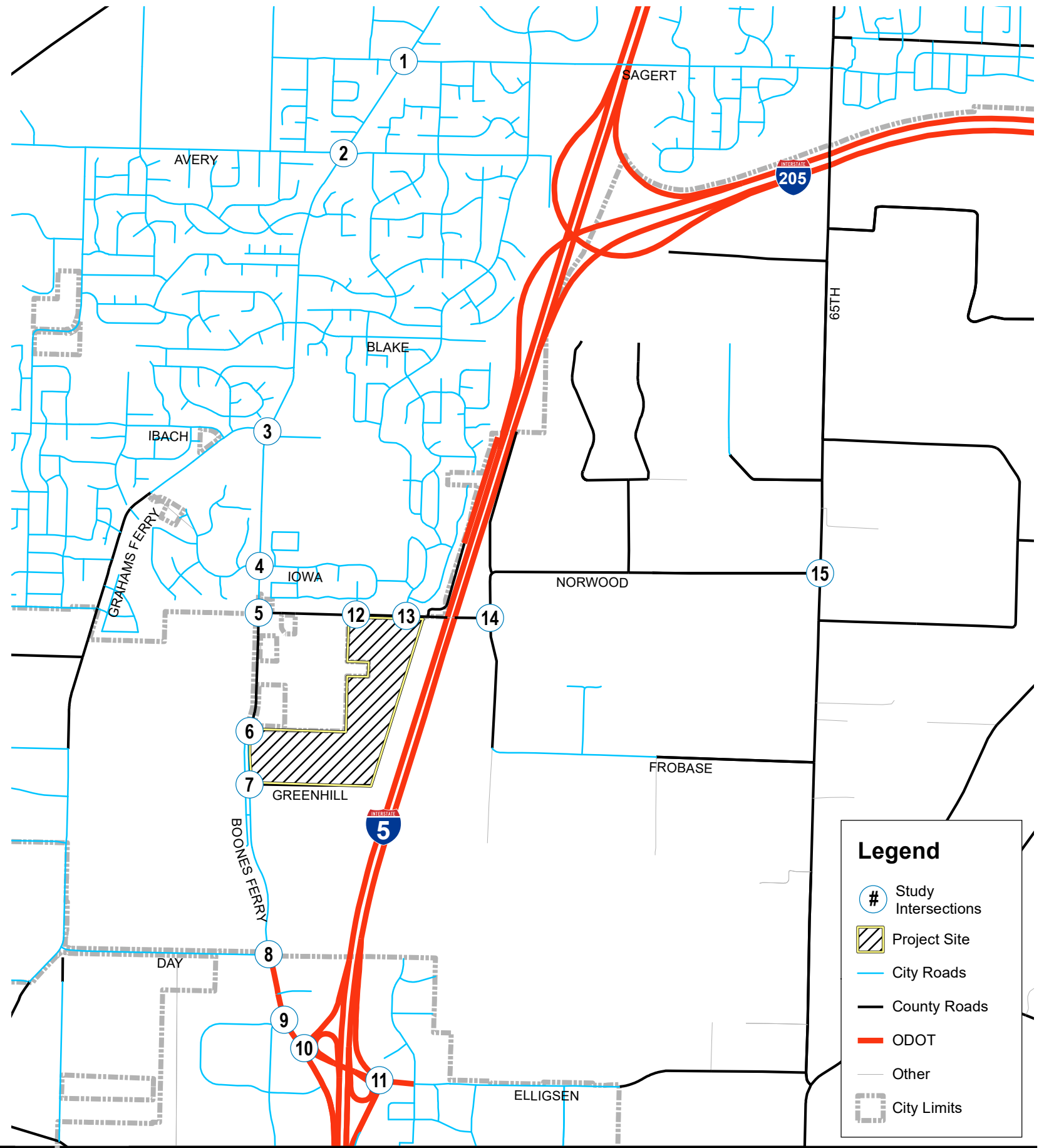
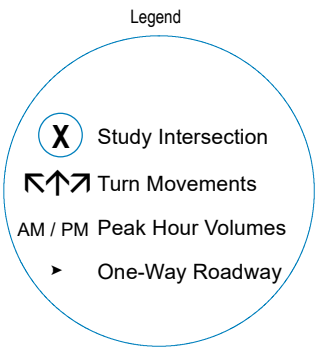
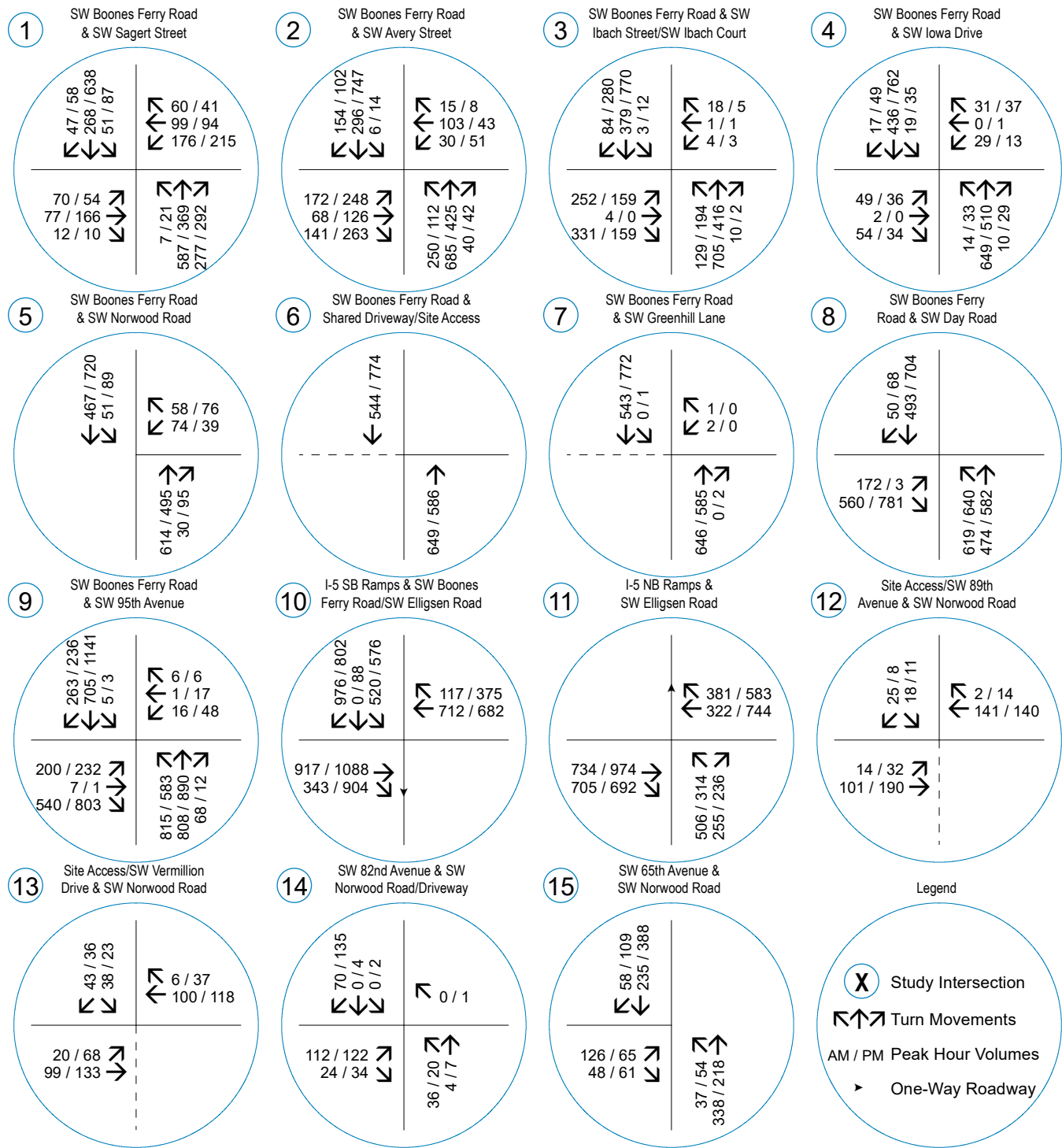

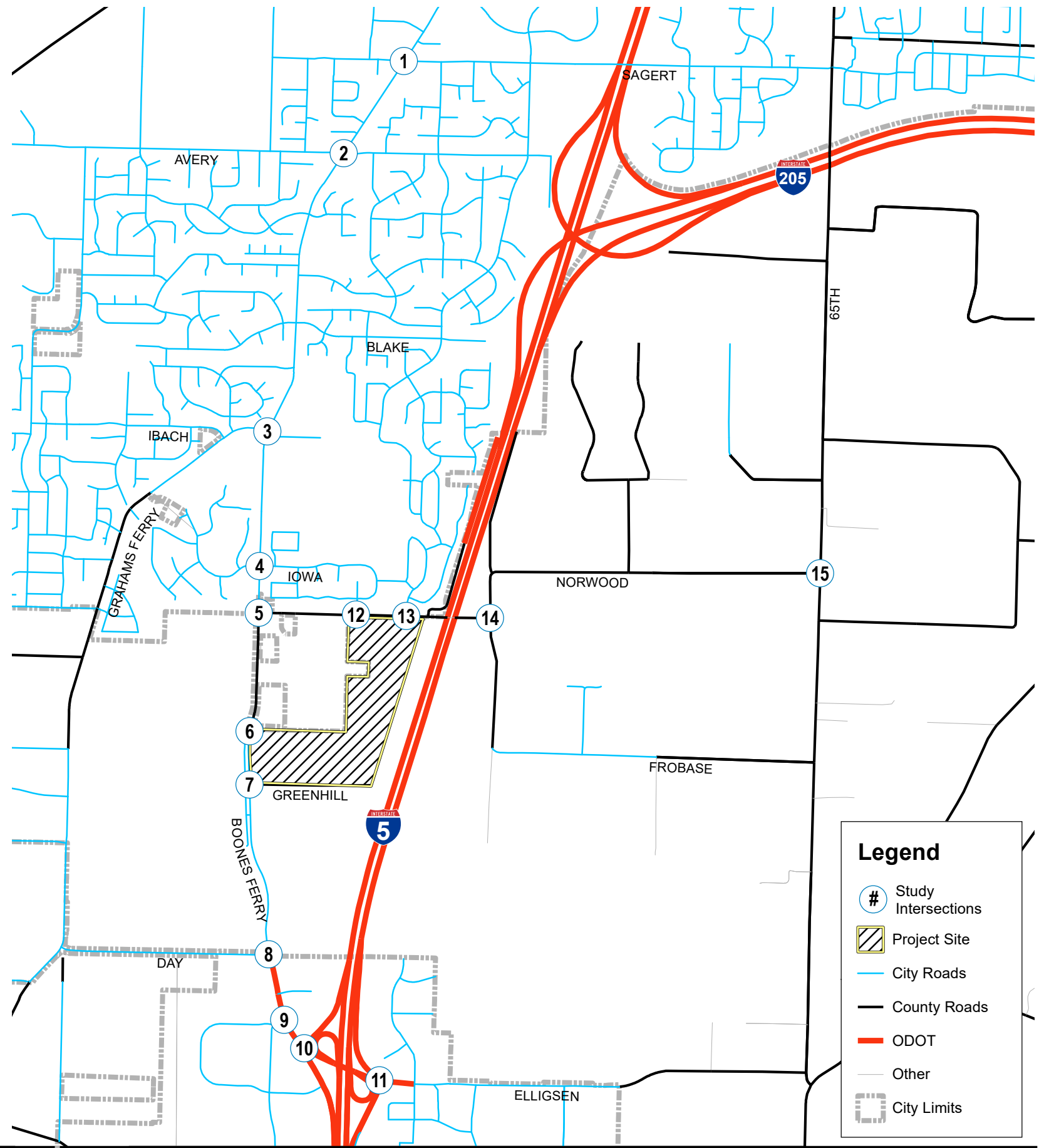
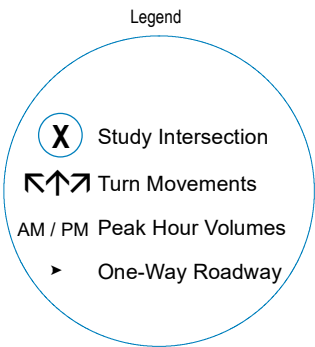
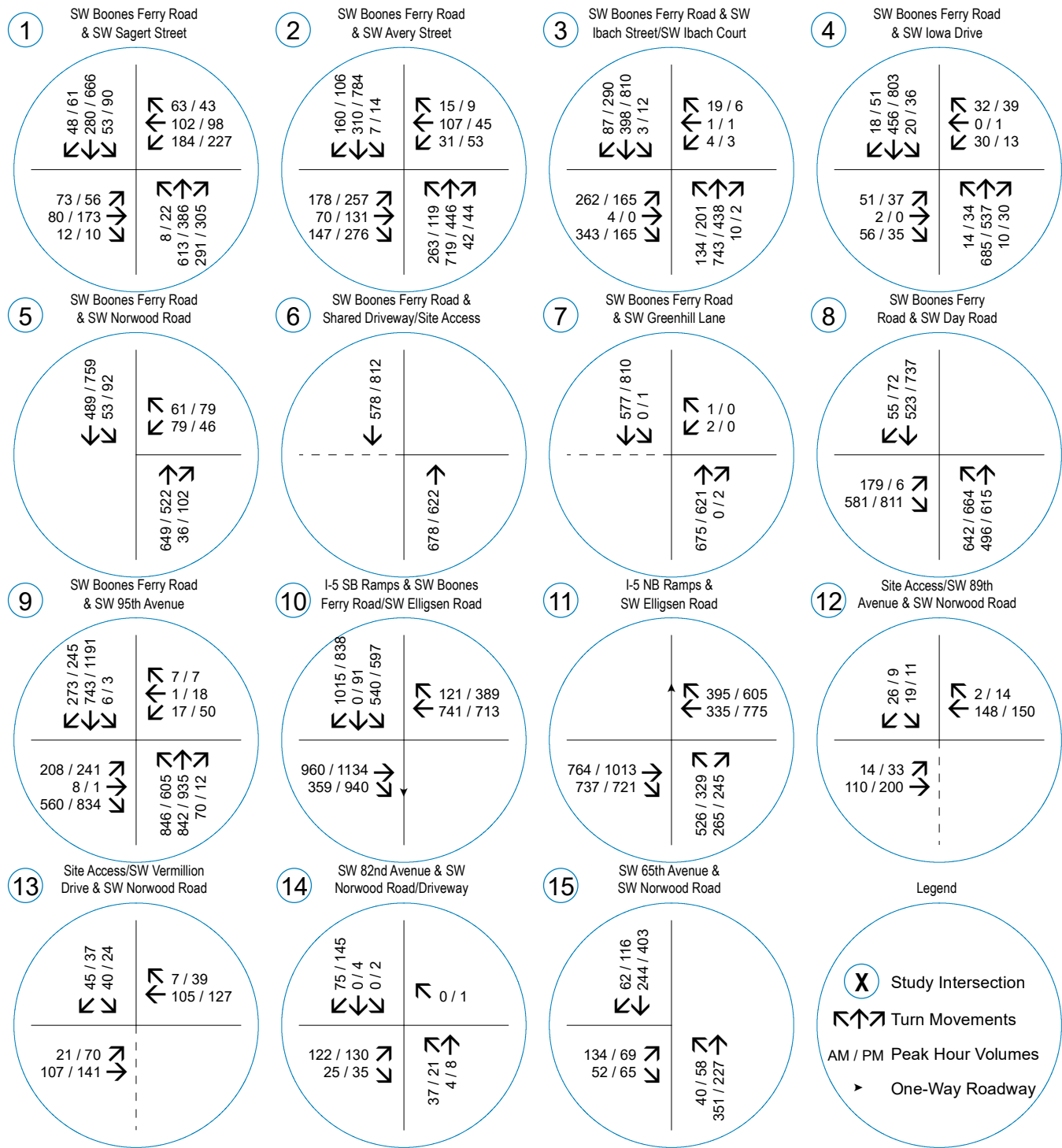

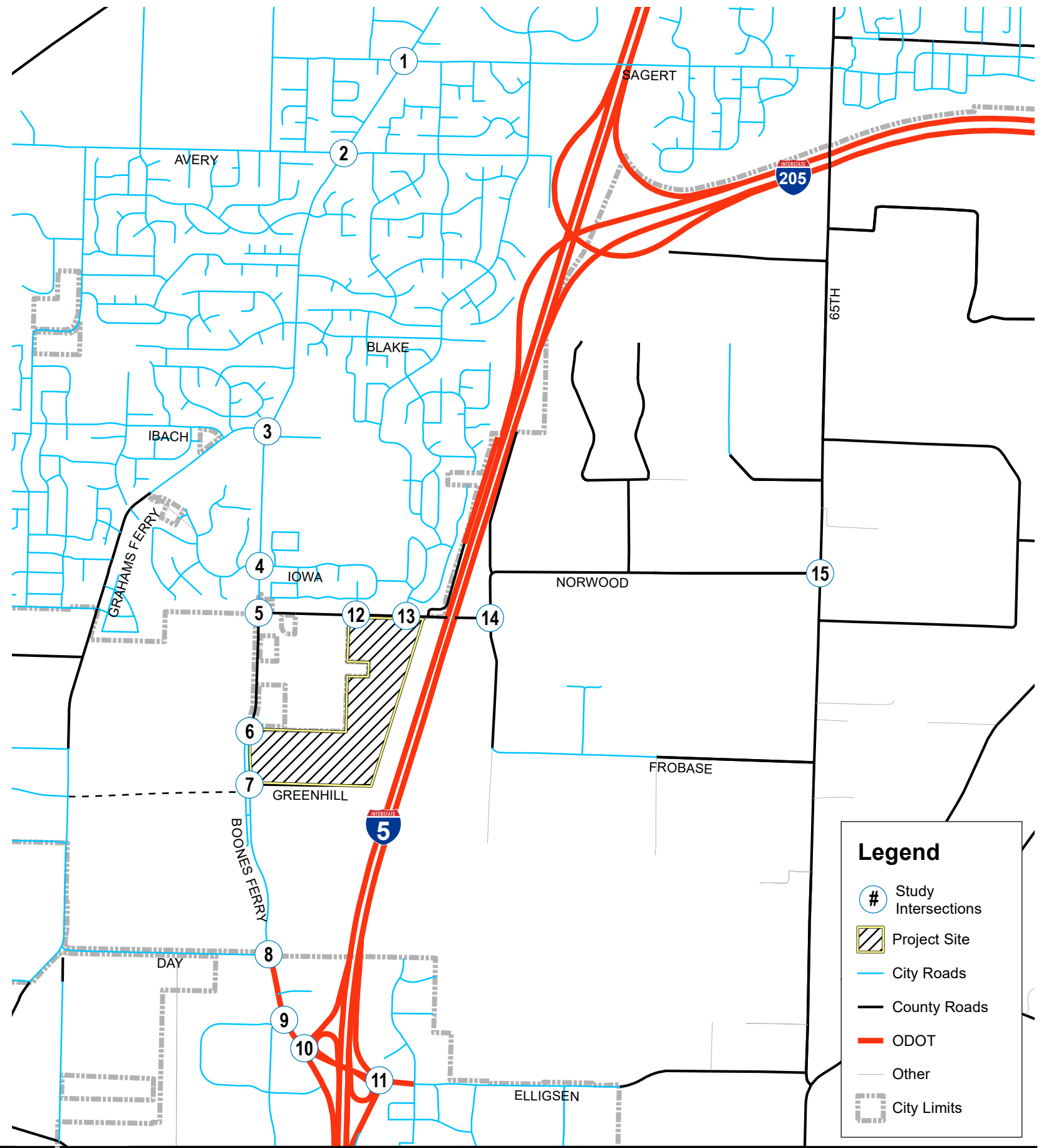
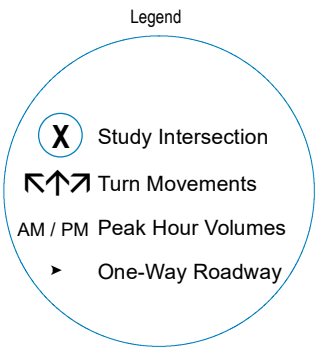
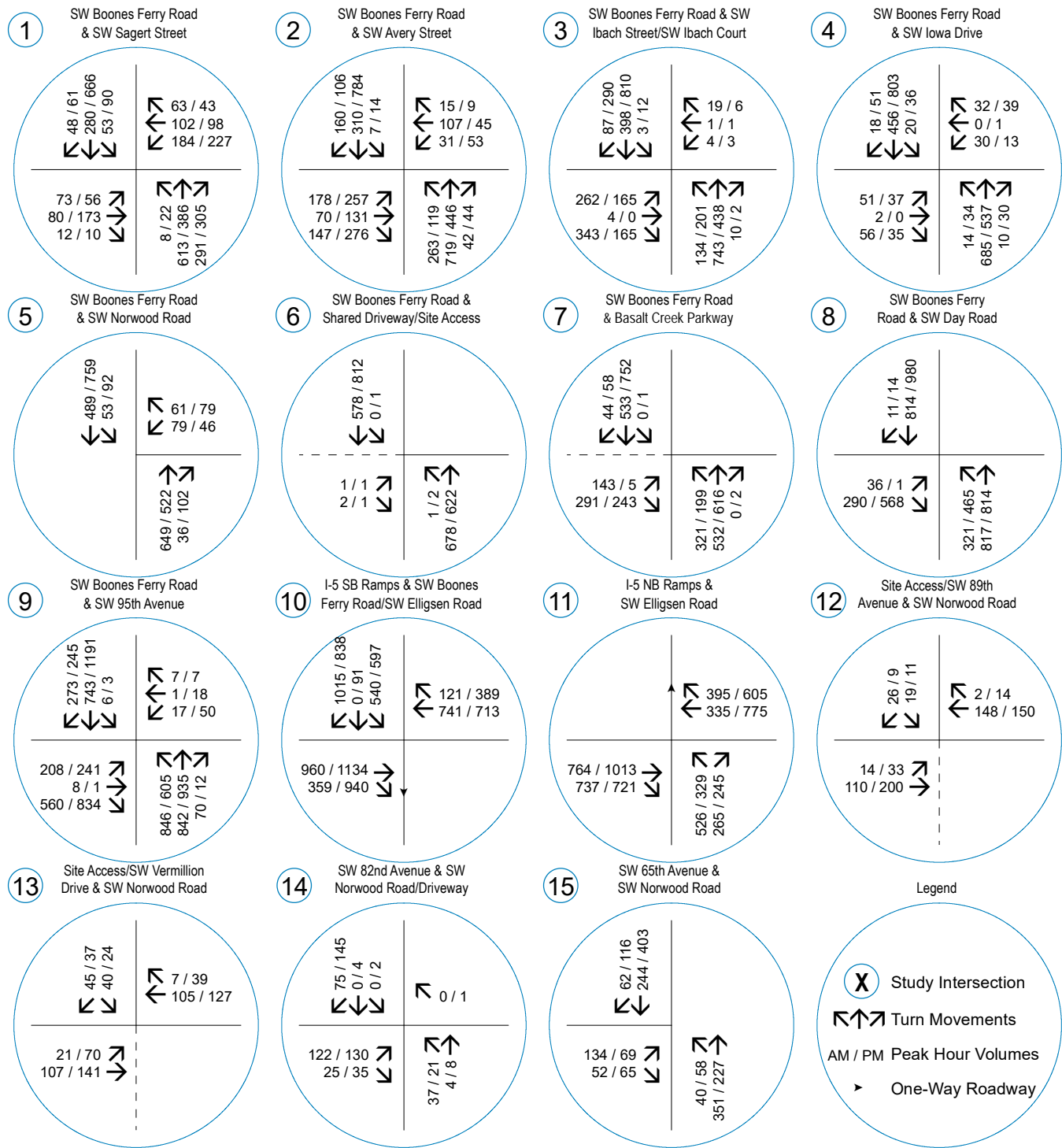

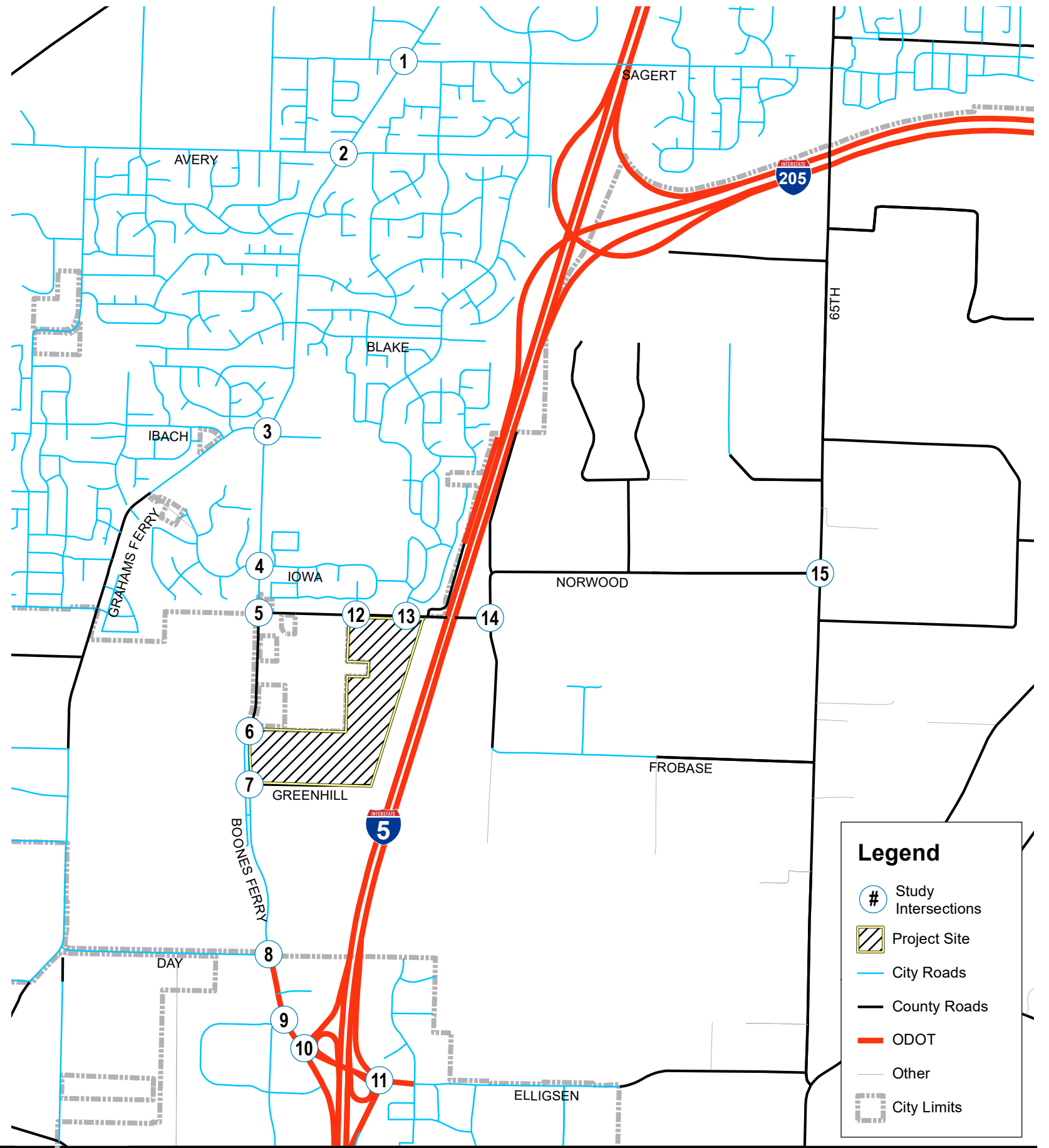
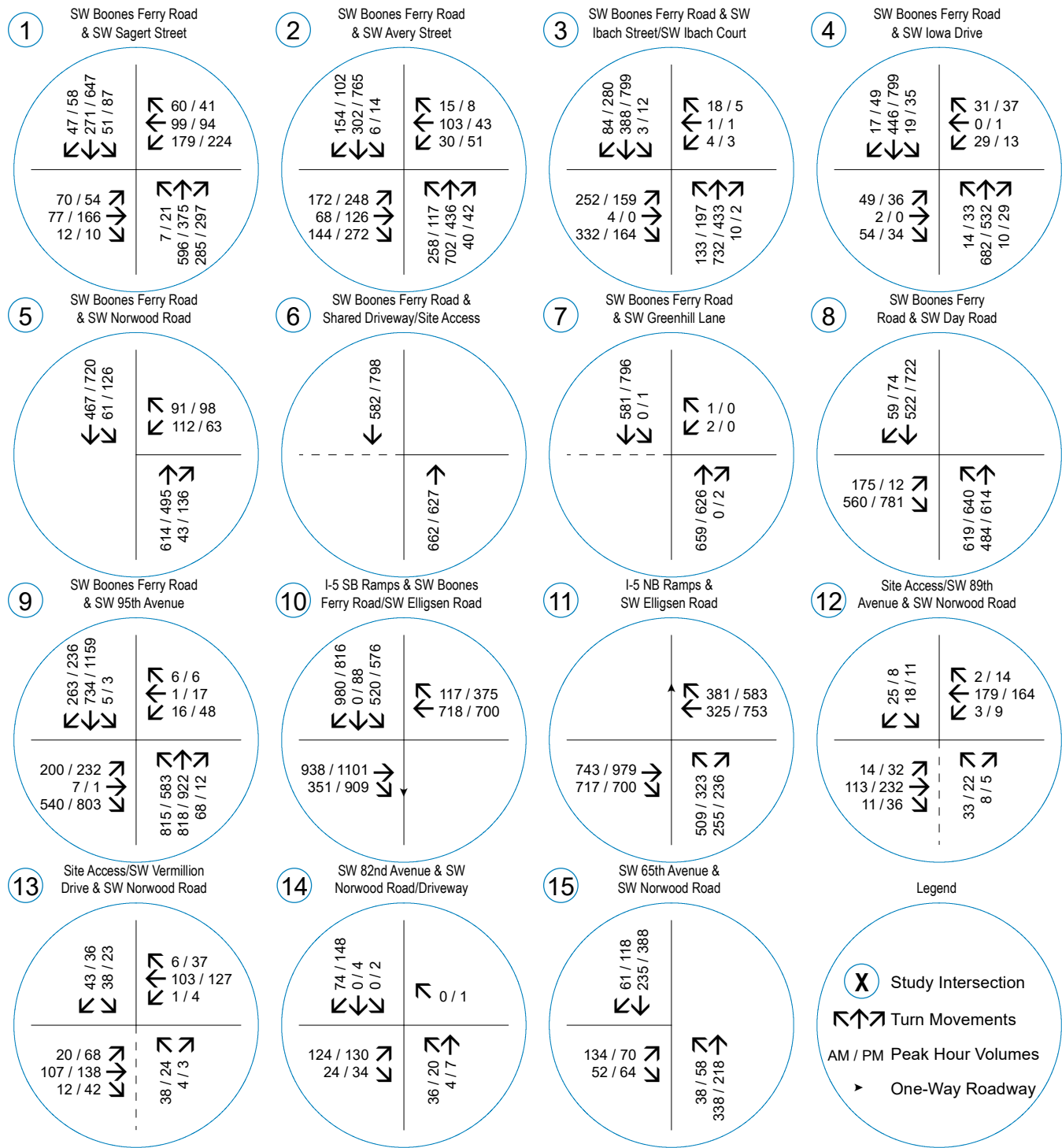

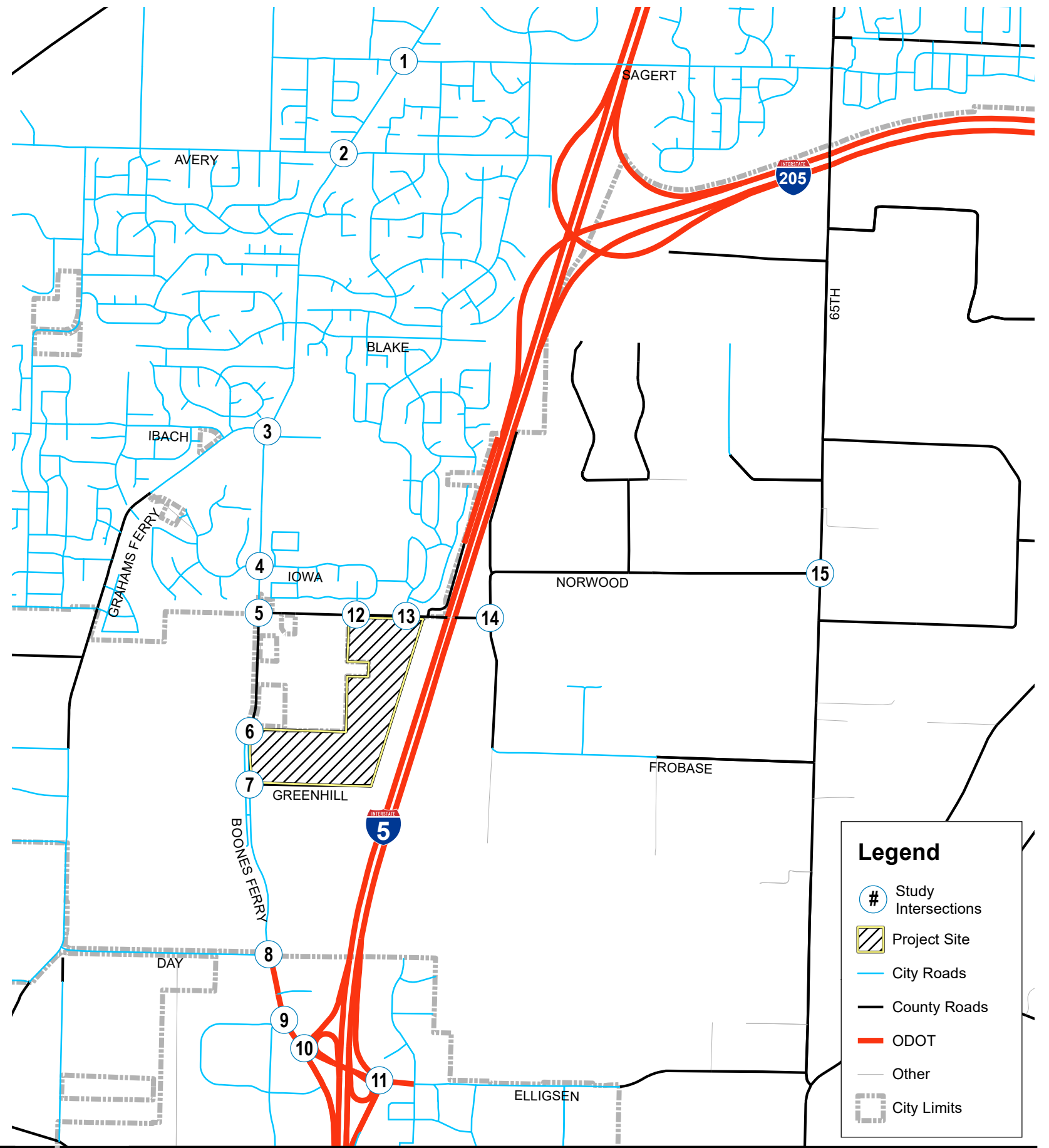
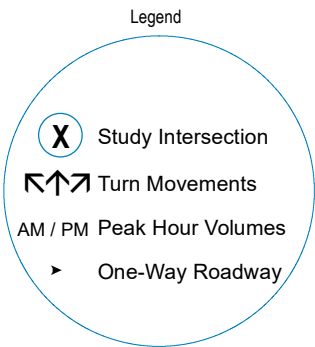
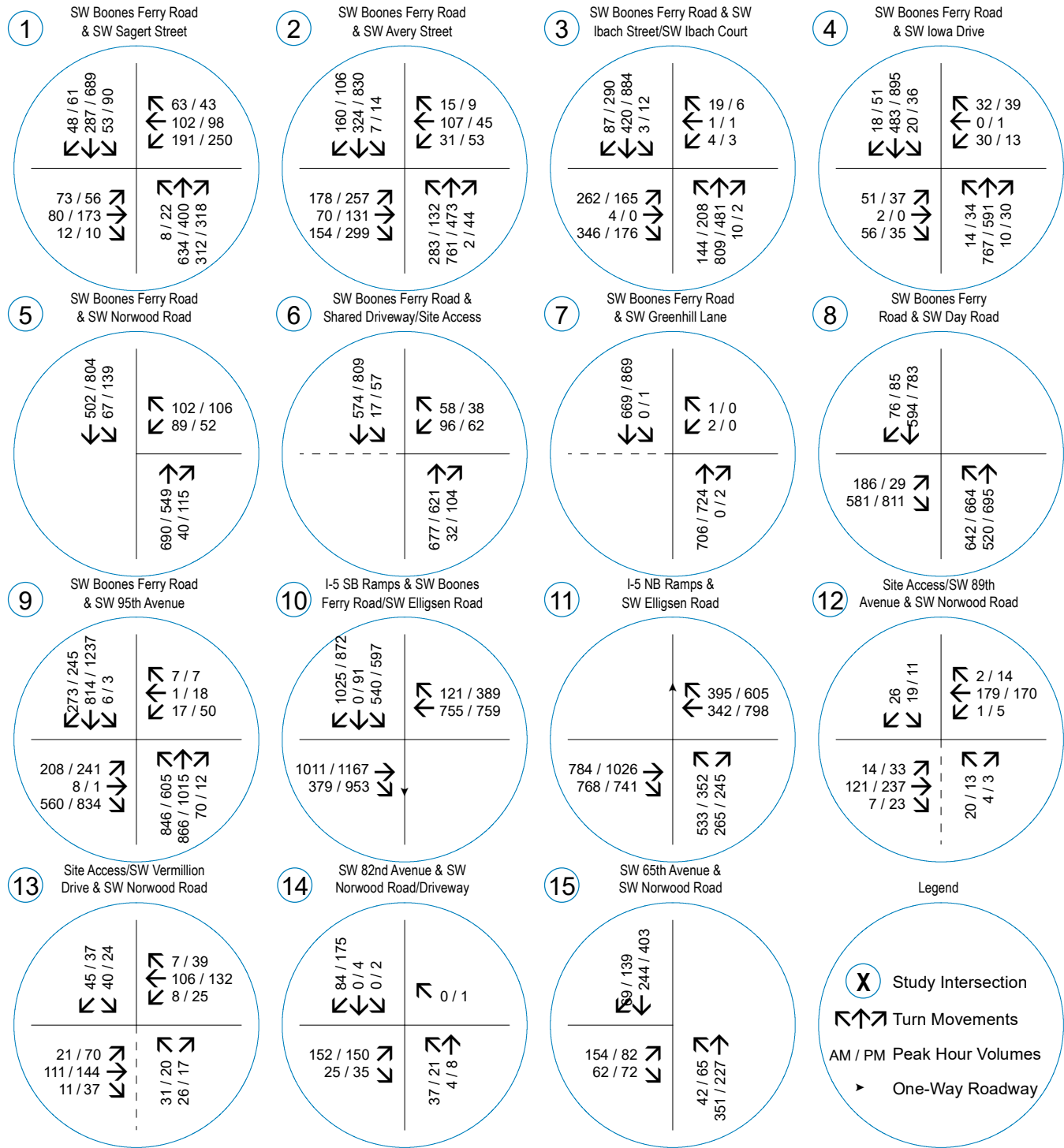

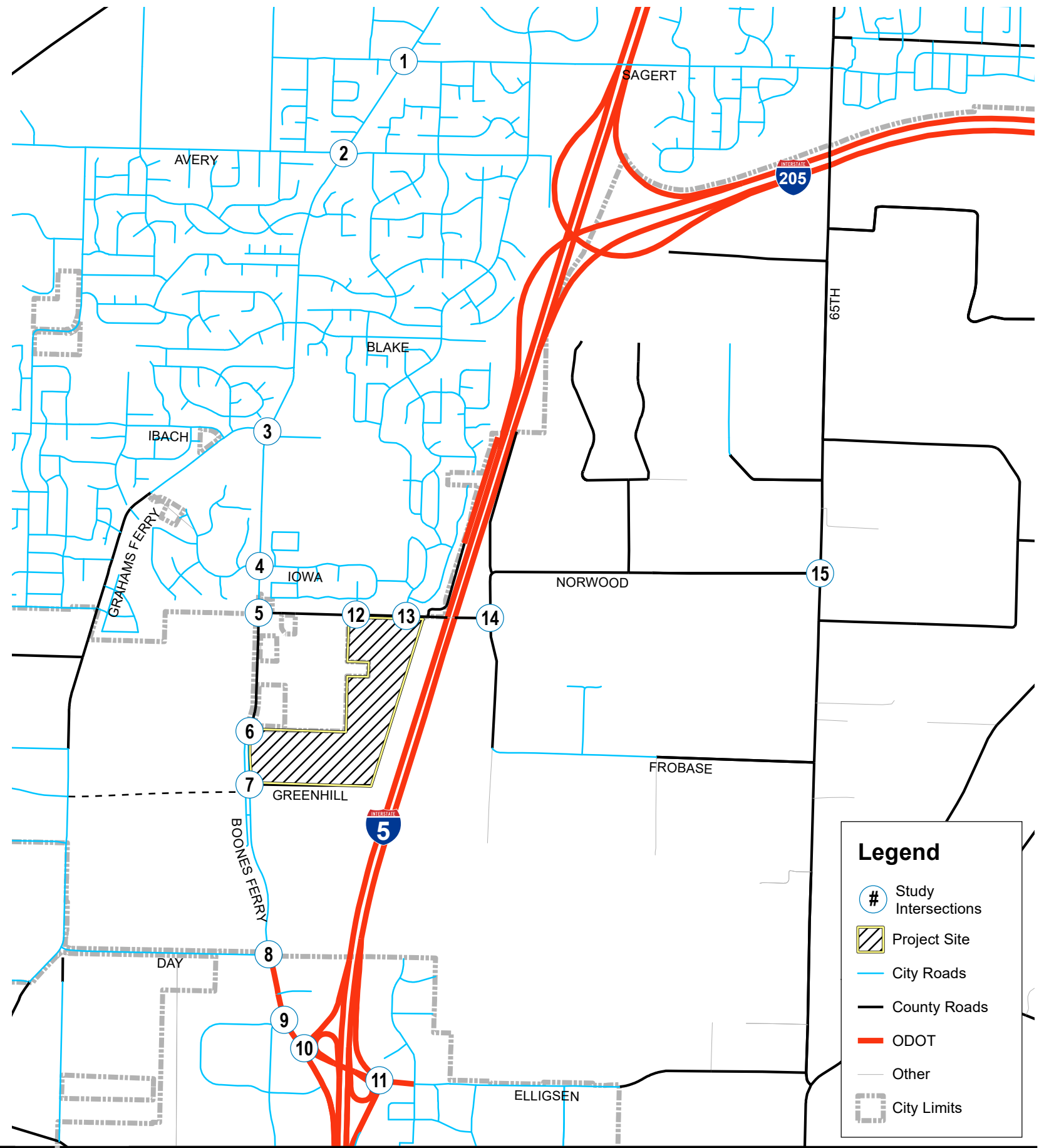
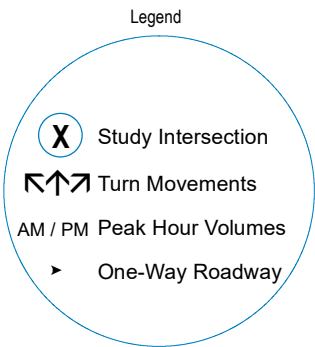
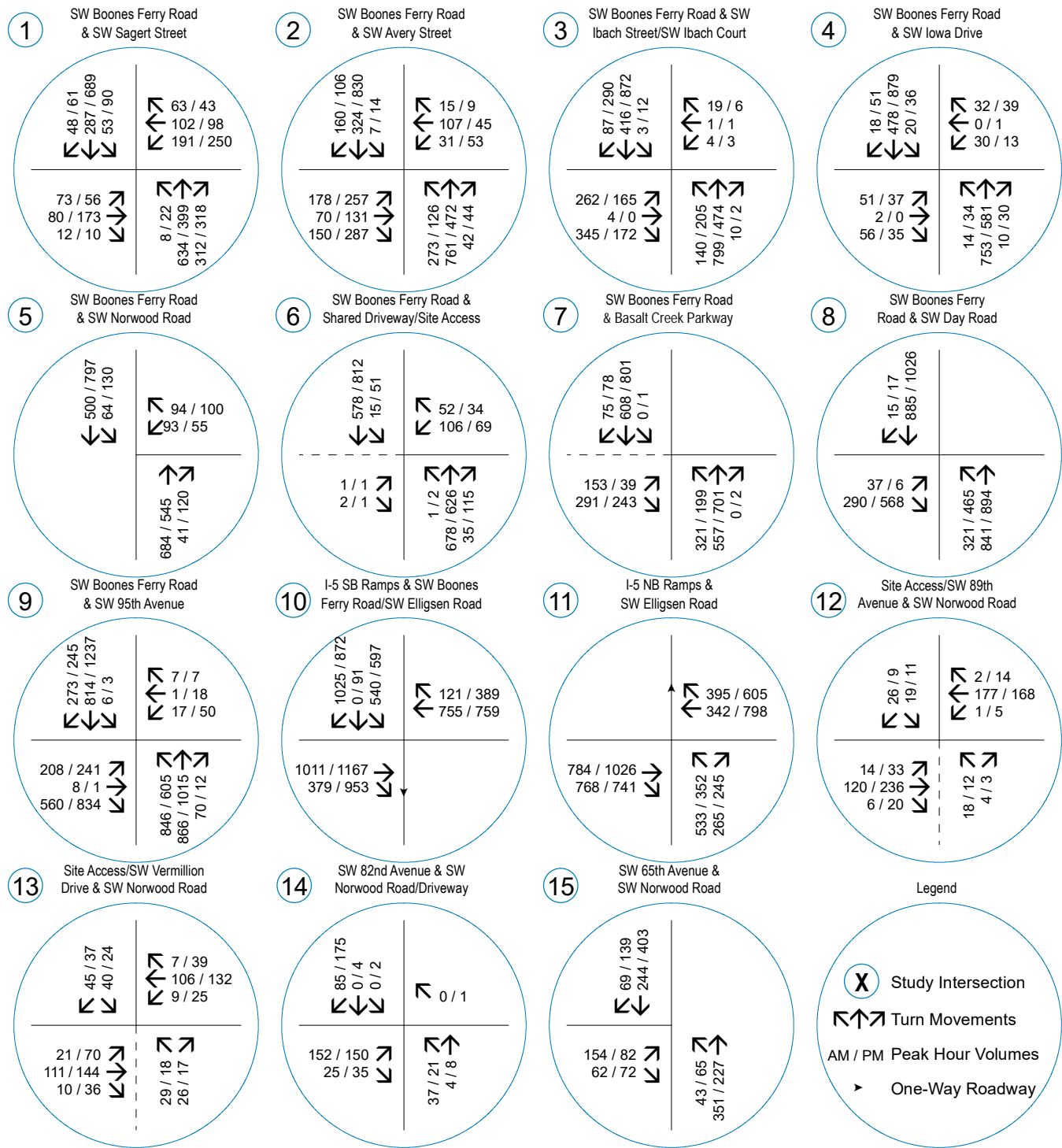

Safety Analysis

Crash History Review

Using data obtained from ODOT’s Crash Data System, a review of approximately five years of the most recent available crash history (January 2015 through December 2019) was performed at the study intersections. The crash data was evaluated based on the number of crashes, the type of collisions, and the severity of the collisions. Crash severity is based on injuries sustained by people involved in the crash, and includes five categories:

- Property Damage Only (PDO)
- Possible Injury (Injury C)
- Non-Incapacitating Injury (Injury B)
- Incapacitating Injury (Injury A)
- Fatality or Fatal Injury

Crash rates provide the ability to compare safety risks at different intersections by accounting for both the number of crashes that have occurred during the study period and the number of vehicles that typically travel through the intersection. Crash rates were calculated using the common assumption that traffic counted during the evening peak period represents approximately 10 percent of the annual average daily traffic (ADT) at the intersection.

Table 6 provides a summary of crash types while Table 7 summarizes crash severities and rates for each of the study intersections. Detailed ODOT crash reports are included in Appendix C.

Table 6: Crash Type Summary

	Intersection	Crash Type							Total Crashes	
		Rear End	Turning	Fixed Object	Angle	Bicycle	Head On	Ped Involved		Sideswipe
1	SW Boones Ferry Road & SW Sagert Street	8	7	0	2	2	0	0	0	19
2	SW Boones Ferry Road & SW Avery Street	17	4	2	0	0	0	0	0	23
3	SW Boones Ferry Road & SW Ibach Street/Court	3	1	1	0	0	0	1	0	6
4	SW Boones Ferry Road & SW Iowa Drive	1	2	0	0	2	0	0	0	5
5	SW Boones Ferry Road & SW Norwood Road	1	3	1	0	0	0	0	0	5
8	SW Boones Ferry Road & SW Day Road	9	2	1	0	0	1	0	1	14
9	SW Boones Ferry Road & SW 95 th Avenue	3	1	1	0	0	0	0	0	5



Table 6: Crash Type Summary

Intersection		Crash Type								Total Crashes
		Rear End	Turning	Fixed Object	Angle	Bicycle	Head On	Ped Involved	Sideswipe	
10	I-5 Southbound Off-Ramp & SW Elligsen Road	30	7	0	2	0	0	0	0	39
11	I-5 Northbound Off-Ramp & SW Elligsen Road	18	2	0	1	0	0	0	0	21
15	SW 65 th Avenue & SW Norwood Road	1	1	0	0	0	0	0	0	2

Table 7: Crash Severity and Rate Summary

Intersection		Crash Severity					Total Crashes	PHV	Crash Rate	90 th % Rate
		PDO	C	B	A	Fatal				
1	SW Boones Ferry Road & SW Sagert Street	8	6	4	1	0	19	1,968	0.53	0.860
2	SW Boones Ferry Road & SW Avery Street	14	8	1	0	0	23	2,101	0.60	0.860
3	SW Boones Ferry Road & SW Ibach Street	1	4	1	0	0	6	1,918	0.17	0.860
4	SW Boones Ferry Road & SW Iowa Drive	1	1	2	1	0	5	1,411	0.19	0.408
5	SW Boones Ferry Road & SW Norwood Road	4	1	0	0	0	5	1,429	0.19	0.293
8	SW Boones Ferry Road & SW Day Road	7	6	0	1	0	14	2,621	0.29	0.509
9	SW Boones Ferry Road & SW 95 th Avenue	4	1	0	0	0	5	3,814	0.07	0.860
10	I-5 Southbound Off-Ramp & SW Elligsen Road	25	13	1	0	0	39	4,428	0.48	0.509
11	I-5 Northbound Off-Ramp & SW Elligsen Road	9	11	1	0	0	21	3,469	0.33	0.509
15	SW 65 th Avenue & SW Norwood Road	1	0	1	0	0	2	845	0.13	0.293



Crash Severity

None of the crashes reported in the five-year analysis period resulted in a fatality but three of the crashes resulted in an incapacitating injury (Type A):

- A turning collision reported at the intersection of SW Boones Ferry Road at SW Sagert Street resulted in two incapacitating injuries. The crash involved three vehicles with the driver at fault making an improper turn.
- A turning collision reported at the intersection of SW Boones Ferry Road at SW Iowa Drive resulted in one incapacitating injury. The crash involved two vehicles with the driver at fault failing to yield the right of way.
- A fixed object collision reported at the intersection of SW Boones Ferry Road at SW Day Road resulted in one incapacitating injury. The crash involved a single vehicle on a rainy day with the driver at fault driving improperly

Pedestrian and Bicycle Collisions

Four of the report crashes involved a bicyclist and one of the reported crashes involved a pedestrian:

- A bicyclist traveling southbound on SW Boones Ferry Road was reportedly struck by a westbound vehicle on SW Sagert Street making a right turn. The bicyclist sustained Type B (non-incapacitating) injuries and the driver was reported at fault.
- A bicyclist riding westbound on the sidewalk on SW Sagert Street was reportedly struck by a vehicle backing northbound from an alley near SW Boones Ferry Road. The bicyclist sustained Type B (non-incapacitating) injuries and the driver was reported as having an obstructed view.
- A pedestrian walking southbound in the west crosswalk was reportedly struck by a northbound vehicle making a left turn onto SW Ibach Street. The pedestrian sustained Type C (possible) injuries and the driver was report at fault for disregarding the traffic signal.
- A bicyclist traveling northbound on SW Boones Ferry Road was reportedly struck by a northbound vehicle making a right turn onto SW Iowa Drive. The bicyclist sustained Type B (non-incapacitating) injuries and the driver was reported at fault.
- A bicyclist traveling northbound on SW Boones Ferry Road was reportedly struck by a northbound vehicle making a left turn onto SW Iowa Drive. The bicyclist sustained Type B (non-incapacitating) injuries and the driver was reported at fault.

ODOT 90th Percentile Crash Rates

Intersection crash rates were compared to the published statewide 90th percentile crash rates within ODOT's Analysis Procedures Manual (APM). According to Exhibit 4-1: Intersection Crash Rates per MEV by Land Type and Traffic Control in the APM, intersections which experience crash rates in excess of 90th percentile crash rates should be "flagged for further analysis".

None of the intersections in the study area were calculated to have crash rates that exceed the 90th percentile crash rates for the intersection type.

ODOT SPIS Review

According to the ODOT TransGIS website, none of the study area intersections were listed in the worst 15 percent of ODOT's 2019 Safety Priority Index System (SPIS) list.

Washington County SPIS List

One of the study area intersections is listed in the Washington County 2015-2017 SPIS List. The intersection of SW Day Road is ranked 323 of 365 based on 11 crashes over a three-year period. The crash analysis shows that most (65 percent) crashes were rear-end collisions and the severity was generally low.

Conclusion

Based on a review of the most recent five years of available crash data, no significant trends or crash patterns were identified at any of the study intersections. Accordingly, no safety mitigation is recommended per the crash data analysis.

Sight Distance

Both SW Boones Ferry Road and SW Norwood Road are under Washington County jurisdiction so intersection sight distance (ISD) was measured and evaluated in accordance with Washington County Community Development Code (CDC) Section 501-8.5.F. Sight distance measurements were made from an entering driver's eye height of 3.5 feet above the roadway surface 15 feet behind the curb line/edge of pavement of the intersecting street to the position of an oncoming vehicle in the major-street traffic lane 4.25 feet above the roadway.

SW Boones Ferry Road Site Access

At the proposed site access on SW Boones Ferry Road, the posted speed is 45 mph, and the roadway has a bike lane which shifts the closest travel lane approximately 7 feet from the curb. Assuming a travel speed 5 mph over the posted speed results in an intersection sight distance requirement of 500 feet. Observations at the proposed site access show that at least 500 feet is available looking in either direction as measured from the edge of the closest vehicular travel lane. Photos are included in Appendix C.

SW Norwood Road Site Accesses

At the proposed site accesses on SW Norwood Road, the posted speed is 45 mph, and the roadway has no bike facilities. Assuming a travel speed 5 mph over the posted speed results in an intersection sight distance requirement of 500 feet. Due to foliage along the roadside, accurate sight distance measurements cannot be taken along the future roadway frontage. SW Norwood Road is straight and horizontal curvature is not anticipated to be an issue. The elevation profiles show that vertical curvature is unlikely to be an issue as well. Based on this preliminary assessment, the 500-foot sight distance requirement is expected to be satisfied at both site accesses on SW Norwood Road. The profiles are included in Appendix C.

Access Spacing

Since all site access will be taken from roadways under Washington County jurisdiction, the county access requirements in Article V of the Community Development Code apply.

SW Boones Ferry Road Site Access

For SW Boones Ferry Road with an arterial classification, the access spacing standard is 600 feet measured between the edge of travel lanes or easements on both sides of the roadway.

To the south, the proposed site access is planned to be approximately 560 feet north of SW Greenhill Lane and aligned opposite a future frontage road connection on the west side of the street, as requested by Washington County. This frontage road is currently closed but will likely be opened when the Basalt Creek Parkway is extended. Siting the driveway further to the north to meet the 600-foot standard on the east side would create an offset intersection but the offset would not create the hazard where vehicles traveling in opposing directions could meet head on in the center refuge lane. However, when measuring the spacing from driveways on the opposite side of the street, the standards would still not be met.

To the north, the proposed site access is planned to be approximately 150 feet south an existing access serving some of the Horizon Christian School facilities. Overall spacing will be improved with consolidation this access, the school facilities access, and the Plambeck Gardens access on the east side of the street. Thus, on the east side of SW Boones Ferry Road, the main entrance to the school would become the closest access at more than 800 feet. On the west side of SW Boones Ferry Road, a driveway serving a single-family home will be the closest access at approximately 270 feet.

SW Norwood Road Site Accesses

For SW Norwood Road with a collector classification, the access spacing standard is 100 feet measured between the edge of travel lanes or easements on both sides of the roadway. Both proposed site accesses will meet this standard.

Warrant Analysis

Turn lane warrants and preliminary traffic signal warrants were examined for the study intersections where such treatments would be applicable. A supplemental memorandum addressing potential development of the commercial parcels abutting SW Boones Ferry Road is included in Appendix E. This memorandum includes warrant evaluations for several potential commercial development scenarios of different intensities.

Left-Turn Lane Warrants

SW Boones Ferry Road already has a center refuge lane that would be serve as a left-turn lane for the site access at that location; however, left-turn lanes are not present on SW Norwood Road. The left-turn lane warrants were examined at the two site accesses on SW Norwood Road using the methodology outlined in the National Cooperative Highway Research Program Report (NCHRP) 457, published by the Transportation Research Board in 2001. These turn-lane warrants are evaluated based on the number of left-turning vehicles, the number of advancing and opposing vehicles, and the roadway travel speed. The results are summarized in Table 8 for year 2026 conditions with full buildout of the proposed development. Detailed information on the warrant analysis is included in Appendix C.

Table 8: Summary of Left-Turn Lane Warrant Evaluation

Intersection & Scenario & Direction	Warrant Met?	
	Morning Peak	Evening Peak
12. SW 89th Ave/Site Access SW Norwood Road		
2026 Buildout – Phases 1–4 – Eastbound	No	No
2026 Buildout – Phases 1–4 – Westbound	No	No
13. SW Vermillion Drive/Site Access SW Norwood Road		
2026 Buildout – Phases 1–4 – Eastbound	No	No
2026 Buildout – Phases 1–4 – Westbound	No	No

As shown in Table 8, left-turn lane warrants are not met at either proposed site access intersection for either peak hour under the 2026 buildout scenario for any analysis period or direction of travel.

Right-Turn Lane Warrants

Right-turn lane warrants were examined all three site accesses using and ODOT methodology. These turn-lane warrants were evaluated based on the number of right-turning vehicles, the number of advancing vehicles, and the roadway travel speed. The results are summarized in Table 9 for Year 2024 conditions with Phases 1 and 2 and Year 2026 conditions with full buildout of the proposed development. Detailed information on the warrant analysis is included in Appendix C.

Table 9: Summary of Right-Turn Lane Warrant Evaluation

Intersection & Scenario	Warrant Met?	
	Morning Peak	Evening Peak
6. SW Boones Ferry Road/Site Access – Northbound		
2026 Buildout – Phases 1–4	Yes	Yes
12. SW 89th Avenue/Site Access/SW Norwood Road – Eastbound		
2024 Buildout – Phases 1–2	No	Yes
2026 Buildout – Phases 1–4	No	No
13. SW Vermillion Drive/Site Access/SW Norwood Road – Eastbound		
2024 Buildout – Phases 1–2	No	No
2026 Buildout – Phases 1–4	No	No

As shown in Table 9, right-turn lane warrants are met at the proposed site access on SW Boones Ferry Road under the 2026 buildout scenario for both analysis periods. Given the 45-mph posted speed and higher traffic volumes, a northbound turn lane is recommended at this access.

Right-turn lane warrants are not met at either proposed site access on SW Norwood Road for either peak hour under the 2026 buildout scenario for any analysis period. The warrant is initially met at the site access opposite



SW 89th Avenue at SW Norwood Road under 2024 Buildout conditions; however, the lane is not needed once the site access at SW Boones Ferry Road is opened. Therefore, no right-turn lane is recommended.

Preliminary Traffic Signal Warrants

Preliminary traffic signal warrants were examined at the unsignalized study area intersections to determine whether the installation of a new traffic signal will be warranted at these intersections upon completion of the proposed development. The results are summarized in Table 10 for Year 2024 conditions with Phases 1 and 2 and Year 2026 conditions with full buildout of the proposed development. Detailed information on the warrant analysis is included in Appendix C.

Table 10: Summary of Preliminary Traffic Signal Warrant Evaluation

Intersection & Scenario	Warrant Met?	
	Based on Morning Peak	Based on Evening Peak
4. SW Iowa Street at SW Boones Ferry Road		
2026 Buildout – Phases 1–4	No	No
5. SW Norwood Road at SW Boones Ferry Road		
2024 Buildout – Phase 1–2	No	No
2026 Buildout – Phases 1–4	No	No
6. Site Access/Frontage Road at SW Boones Ferry Road		
2026 Buildout – Phases 1–4	No	No
12. SW 89th Avenue/Site Access/SW Norwood Road		
2024 Buildout – Phase 1–2	No	No
2026 Buildout – Phases 1–4	No	No
13. SW Vermillion Drive/Site Access/SW Norwood Road		
2024 Buildout – Phase 1–2	No	No
2026 Buildout – Phases 1–4	No	No
14. SW 82nd Avenue & SW Norwood Road		
2026 Buildout – Phases 1–4	No	No
15. SW 65th Avenue & SW Norwood Road		
2026 Buildout – Phases 1–4	No	No

As shown in Table 10, traffic signal warrants are not met at any of these intersection for either peak hour under either buildout scenario for any analysis period.



Operational Analysis

The operations of the transportation were evaluated for the morning and evening peak hours for existing conditions and the future scenarios without and with the proposed development presented in this TIS. A supplemental memorandum addressing potential development of the commercial parcels abutting SW Boones Ferry Road is included in Appendix E. This memorandum includes operations analysis for several potential commercial development scenarios of different intensities.

Intersection Capacity Analysis

A capacity and delay analysis were conducted for each of the study intersections per the signalized and unsignalized intersection analysis methodologies in the *Highway Capacity Manual (HCM)*². Intersections are generally evaluated based on the average control delay experienced by vehicles and are assigned a grade according to their operation. The level of service (LOS) of an intersection can range from LOS A, which indicates very little, or no delay experienced by vehicles, to LOS F, which indicates a high degree of congestion and delay. The volume-to-capacity (v/c) ratio is a measure that compares the traffic volumes (demand) against the available capacity of an intersection.

The analysis was performed using the Synchro (version 10) software which applies the HCM6 methodologies for all but one signalized intersection. At the intersection of the I-5 Southbound Ramps at SW Elligsen Road, the intersection has a nonstandard signal phasing plan that is not accepted by HCM6. Therefore, the HCM2000 methodology was applied at this intersection.

The overall signalized v/c ratios were calculated following the methodologies in Chapter 16 of the ODOT APM for the critical intersection v/c ratio. This methodology was performed for all signalized intersections.

Performance Standards

The following agency performance standards are applicable in the study area:

- The **City of Tualatin** requires intersections to operate at a minimum D and E for signalized and unsignalized intersections, respectively.
- **Washington County** requires intersections to operate with a v/c ratio of 0.99 or less.
- **ODOT** has a target v/c ratio of 0.99 or less for facilities inside Metro except for intersections with highway ramps, which have a target v/c ratio of 0.85.

Delay & Capacity Analysis

The LOS, delay, and v/c results of the capacity analysis are shown in Table 11 for the morning and evening peak hours and six scenarios. Detailed calculations as well as tables showing the relationship between delay and LOS are included in Appendix D.

² Transportation Research Board, *Highway Capacity Manual 6th Edition*, 2016.

Table 11: Capacity Analysis Summary

Intersection & Scenario	Performance Standard	Morning Peak Hour			Evening Peak Hour		
		LOS	Delay (s)	V/C	LOS	Delay (s)	V/C
1. SW Boones Ferry Road & SW Sagert Street							
2021 Existing	D	C	21	0.83	C	21	0.82
2024 Background		C	27	0.87	C	24	0.85
2024 Buildout (Phases 1-2)		C	28	0.88	C	24	0.86
2026 Background		C	30	0.90	C	25	0.88
2026 Buildout (Phases 1-4)		D	35	0.94	C	27	0.91
2026 Buildout w/ BCPE		D	35	0.94	C	27	0.91
2. SW Boones Ferry Road & SW Avery Street							
2021 Existing	E	C	20	0.82	C	34	0.92
2024 Background		C	22	0.84	C	32	0.92
2024 Buildout (Phases 1-2)		C	23	0.85	C	34	0.93
2026 Background		C	25	0.87	D	37	0.96
2026 Buildout (Phases 1-4)		C	28	0.89	D	46	1.01
2026 Buildout w/ BCPE		C	28	0.89	D	44	0.99
3. SW Boones Ferry Road & SW Ibach Street							
2021 Existing	E	B	18	0.78	B	19	0.75
2024 Background		C	21	0.80	C	21	0.79
2024 Buildout (Phases 1-2)		C	23	0.80	C	22	0.81
2026 Background		C	24	0.83	C	23	0.82
2026 Buildout (Phases 1-4)		C	29	0.86	C	27	0.86
2026 Buildout w/ BCPE		C	28	0.86	C	26	0.85
4. SW Boones Ferry Road & SW Iowa Drive							
2021 Existing	E	E	50	0.61	F	52	0.49
2024 Background		F	72	0.75	F	71	0.61
2024 Buildout (Phases 1-2)		F	86	0.81	F	85	0.67
2026 Background		F	100	0.87	F	92	0.70
2026 Buildout (Phases 1-4)		F	165	1.06	F	158	0.90
2026 Buildout w/ BCPE		F	153	1.02	F	140	0.85



Table 11: Capacity Analysis Summary

Intersection & Scenario	Performance Standard	Morning Peak Hour			Evening Peak Hour		
		LOS	Delay (s)	V/C	LOS	Delay (s)	V/C
5. SW Boones Ferry Road & SW Norwood Road							
2021 Existing	E	C	22	0.40	C	17	0.28
2024 Background		C	24	0.45	C	18	0.31
2024 Buildout (Phases 1-2)		E	38	0.71	C	25	0.49
2026 Background		D	27	0.51	C	21	0.36
2026 Buildout (Phases 1-4)		E	42	0.72	D	27	0.51
2026 Buildout w/ BCPE		E	40	0.70	D	26	0.5
6. SW Boones Ferry Road & Shared Driveway							
2026 Buildout (Phases 1-4)	E	C	21	0.33	C	21	0.23
2026 Buildout w/ BCPE		D	27	0.43	D	27	0.31
7. SW Boones Ferry Road & Greenhill Lane							
2021 Existing	0.99	B	14	0.01	A	9	0.00
2024 Background		B	15	0.01	A	9	0.00
2024 Buildout (Phases 1-2)		B	15	0.01	A	9	0.00
2026 Background		C	15	0.01	A	9	0.00
2026 Buildout (Phases 1-4)		C	16	0.01	A	9	0.00
2026 Buildout w/ BCPE		C	16	0.01	A	9	0.00
8. SW Boones Ferry Road & SW Day Road							
2021 Existing	0.99	D	37	0.62	C	31	0.61
2024 Background		D	38	0.65	D	42	0.71
2024 Buildout (Phases 1-2)		D	38	0.67	D	50	0.75
2026 Background		D	38	0.65	D	52	0.78
2026 Buildout (Phases 1-4)		D	37	0.73	D	50	0.79
2026 Buildout w/ BCPE		B	19	0.52	C	34	0.67
9. SW Boones Ferry Road & SW 95th Avenue							
2021 Existing	0.99	C	26	0.74	C	23	0.76
2024 Background		C	26	0.78	C	23	0.81
2024 Buildout (Phases 1-2)		C	26	0.79	C	23	0.81
2026 Background		C	26	0.82	C	23	0.84
2026 Buildout (Phases 1-4)		C	26	0.85	C	22	0.86
2026 Buildout w/ BCPE		C	26	0.85	C	23	0.86



Table 11: Capacity Analysis Summary

Intersection & Scenario	Performance Standard	Morning Peak Hour			Evening Peak Hour		
		LOS	Delay (s)	V/C	LOS	Delay (s)	V/C
10. I-5 Southbound Off-Ramp & SW Elligsen Road							
2021 Existing	0.85	C	22	0.86	C	22	0.65
2024 Background		C	25	0.91	C	22	0.70
2024 Buildout (Phases 1-2)		C	25	0.92	C	22	0.72
2026 Background		C	28	0.96	C	21	0.74
2026 Buildout (Phases 1-4)		C	29	0.96	C	21	0.78
2026 Buildout w/ BCPE		C	29	0.96	C	20	0.78
11. I-5 Northbound Off-Ramp & SW Elligsen Road							
2021 Existing	0.85	C	23	0.42	A	8	0.41
2024 Background		C	23	0.45	A	8	0.43
2024 Buildout (Phases 1-2)		C	24	0.45	A	9	0.44
2026 Background		C	24	0.46	A	9	0.45
2026 Buildout (Phases 1-4)		C	24	0.47	A	9	0.46
2026 Buildout w/ BCPE		C	24	0.47	A	9	0.46
12. SW 89th Avenue/Site Access & SW Norwood Road							
2021 Existing	0.99	B	10	0.07	B	10	0.03
2024 Background		B	10	0.07	B	11	0.03
2024 Buildout (Phases 1-2)		B	12	0.09	B	13	0.06
2026 Background		B	10	0.08	B	11	0.03
2026 Buildout (Phases 1-4)		B	12	0.09	B	13	0.04
2026 Buildout w/ BCPE		B	12	0.08	B	13	0.04
13. SW Vermillion Drive/Site Access & SW Norwood Road							
2021 Existing	0.99	B	10	0.12	B	11	0.12
2024 Background		B	10	0.13	B	12	0.13
2024 Buildout (Phases 1-2)		B	12	0.13	C	16	0.14
2026 Background		B	10	0.14	B	12	0.14
2026 Buildout (Phases 1-4)		B	11	0.15	B	14	0.16
2026 Buildout w/ BCPE		B	11	0.15	B	13	0.14



Table 11: Capacity Analysis Summary

Intersection & Scenario	Performance Standard	Morning Peak Hour			Evening Peak Hour		
		LOS	Delay (s)	V/C	LOS	Delay (s)	V/C
14. SW 82nd Avenue & SW Norwood Road							
2021 Existing	0.99	B	11	0.07	B	11	0.09
2024 Background		B	11	0.08	B	12	0.09
2024 Buildout (Phases 1-2)		B	12	0.09	B	12	0.10
2026 Background		B	11	0.09	B	12	0.10
2026 Buildout (Phases 1-4)		B	12	0.11	B	13	0.11
2026 Buildout w/ BCPE		B	12	0.1	B	13	0.11
15. SW 65th Avenue & R SW Norwood Road							
2021 Existing	0.99	C	19	0.41	C	18	0.32
2024 Background		C	21	0.46	C	19	0.36
2024 Buildout (Phases 1-2)		C	22	0.50	C	20	0.39
2026 Background		C	23	0.52	C	21	0.40
2026 Buildout (Phases 1-4)		D	27	0.61	C	24	0.49
2026 Buildout w/ BCPE		D	27	0.61	C	24	0.49
SW Boones Ferry Road & Basalt Creek Parkway Extension							
2026 Buildout w/ BCPE	0.99	C	29	0.86	C	21	0.72

Notes:

BCPE = Basalt Creek Parkway Extension

Locations that do not meet standards are **BOLDED**.

Three intersections show operational results that do not meet standards under at least one scenario.

SW Boones Ferry Road at SW Avery Road

The intersection of SW Boones Ferry Road at SW Avery Street is expected to operate acceptably under all scenarios except the 2026 Buildout conditions where the overall v/c ratio is expected to exceed capacity. With construction of the Basalt Creek Parkway Extension, the intersection is expected to remain congested but would meet the City of Tualatin LOS standard and demand would not exceed capacity.

Another consideration at this intersection is the amount of forecast traffic growth used in this analysis. For background traffic estimates, all study area volumes were grown at an annual rate of 2 percent per year. By 2026, the background growth alone is estimated at 10 percent. With the added traffic from the Plambeck Gardens site as well as the proposed development, the overall growth in volumes at this intersection is estimated at 15.3 percent in the AM peak hour and 16.2 percent during the PM peak hour. A review of historical trends on SW Avery Street from ODOT's Transportation Data Management System shows growth is relatively slow, averaging less than 1 percent per year. Similar trends are present on SW Boones Ferry Road at locations north of SW Sagert Street and north of SW Norwood Road. These trends indicate that the forecasts used in the



analysis are very conservative representations of traffic volume forecasts and the intersection is likely to operate better than the analysis shows.

Although the Tualatin TSP does identify that this intersection will exceed capacity in the long-range forecast (2035), it does not identify any mitigation to address the deficiency.

Based on the operational analysis, which shows that construction of the Basalt Creek Parkway Extension is expected to result in improved operations, and the conservatively high estimates of forecast growth, no mitigation is recommended at this intersection.

SW Boones Ferry Road at SW Iowa Drive

The intersection of SW Boones Ferry Road at SW Iowa Drive is expected to operate with LOS F conditions under all scenarios and demand is expected to exceed capacity under 2026 Buildout conditions during the morning peak hour. Signal warrants are not met at this intersection.

Field observations show that the eastbound approach operates with separate left- and right-turn lanes even though no lane striping is present. The width of the pavement is approximately 40 feet, which allows drivers to naturally create the two lanes so that right turns can be made without having to wait behind a left-turning vehicle. Analysis shows that approach delays are lower, and capacity is adequate when a right-turn lane is added to the eastbound approach.

The westbound approach does not have the same width and cannot as easily accommodate this lane configuration.

The traffic volume forecasts at this intersection are also conservatively high at this intersection, which contributes to the substantial increases in delay forecast for the side streets. The proposed development will not add any traffic to SW Iowa Drive, all traffic is anticipated to travel through on SW Boones Ferry Road.

Since signal warrants are not met and field observations show that delays are lower because the eastbound approach operates with a separate right-turn lane during congested conditions, no mitigation is recommended. However, the City could consider striping separate left- and right-turn lanes on the eastbound approach to formalize the lane configuration.

I-5 Southbound Off-Ramp & SW Elligsen Road

The intersection of the I-5 Southbound Off-Ramp at SW Elligsen Road is expected to operate with a v/c ratio that exceeds the OHP mobility target of 0.85 for freeway ramps for the morning peak hour for the existing condition and all subsequent scenarios.

The 2018 Regional Transportation Plan (RTP) includes Project 11489 at the I-5 Southbound Off-Ramp at SW Boones Ferry (SW Elligsen Road) in the Financially-Constrained project list. The project would construct a second right-turn lane on the exit ramp with the primary purpose to “relieve current congestion” with a secondary objective to “relieve future congestion.” The City of Wilsonville is the nominating agency although the project is on an ODOT facility.

As shown in Table 12, with the addition of the second southbound lane on the off-ramp, the ramps would operate well below the 0.85 mobility target.

Table 12: Capacity Analysis Summary – I-5 Southbound Off-Ramp with RTP Improvement

Intersection & Scenario	Performance Standard	AM Peak Hour			PM Peak Hour		
		LOS	Delay (s)	V/C	LOS	Delay (s)	V/C
10. I-5 Southbound Off-Ramp & SW Elligsen Road							
2026 Background	0.85	C	20	0.63	B	17	0.60
2026 Buildout (Phases 1-4)		C	20	0.66	B	17	0.61

Although the RTP project acknowledges that conditions are currently congested, the time period for the improvement is identified as 2028-2040 with an estimated cost of \$1.06 million in 2016 dollars. This project is not in the current 2021-2024 Statewide Transportation Improvement Program (STIP). The 2024-2027 STIP will have more than \$2 billion in funding to preserve and improve the state transportation system, but projects have not been identified to date.

During the morning peak hour, when the intersection exceeds the mobility target, the proposed development will contribute less than 2.5 percent of the total traffic through the intersection under the 2026 buildout scenario and only 1.0 percent of the traffic on the off-ramp. The difference between the year 2024 background and buildout conditions is 0.01 in the v/c ratio and less than a second of average delay. The difference between the year 2026 background and buildout conditions is negligible for the v/c ratio and about a second of average delay.

Based on the planned improvements for the interchange that are part of the financially-constrained RTP and the relatively small impact of the proposed development, no project mitigation is recommended for this intersection.

Queue Storage

An analysis of queuing was conducted for the site access to review the storage requirements for the site access intersection at SW Boones Ferry Road. The analysis was conducted based on the results of a SimTraffic simulation. Five (5) simulations were conducted, averaged, and the 95th percentile queue estimates were rounded up to the nearest 25 feet, or the approximate length of one vehicle to estimate the queue lengths. Findings include:

- Maximum queues were estimated at two vehicles or 50 feet for the southbound left, which can easily be accommodated in the existing center refuge lane. The recommended striping for the southbound left-turn lane should include 100 feet of storage and the appropriate deceleration for the 45-mph posted speed.
- The northbound left will rarely have a queue since frontage road to the west will only serve a few homes. This lane is recommended to be striped as a two-way, left-turn lane to allow for a two-stage westbound left-turn movement from the site access.
- Maximum queues were estimated at six vehicles or 150 feet for the westbound left-movement with a two-lane approach for the site access. These queues will not affect the closest public street connection ("M" Street) to the east.



Conclusions

Key findings of this study include:

1. The proposed development is estimated to generate 271 morning peak hour, 358 evening peak hour, and 3,596 daily trips.
2. Based on a review of the most recent five years of available crash data, no significant trends or crash patterns were identified at any of the study intersections. Accordingly, no safety mitigation is recommended per the crash data analysis.
3. At the proposed site access on SW Boones Ferry Road, field observations show that at least 500 feet is available looking in either direction as measured from the edge of the closest vehicular travel lane.
4. At the proposed site accesses on SW Norwood Road, dense foliage restricts existing sight lines; however, preliminary assessment of horizontal and vertical curvature indicate that the 500-foot sight distance requirement is expected to be satisfied.
5. On SW Boones Ferry Road, the access spacing standard of 600 feet will not be met with construction of the access aligned opposite a future frontage road connection on the west side of the street, as requested by Washington County. Overall spacing will be improved with consolidation of access on the east side of the street.
6. On SW Norwood Road, the access spacing standard of 100 feet will be met with construction of the site accesses aligned opposite existing roadways.
7. Left-turn lane warrants are not met at either proposed site access intersection on SW Norwood Road for either peak hour under the 2026 buildout scenario for any analysis period or direction of travel.
8. Right-turn lane warrants are met at the proposed site access on SW Boones Ferry Road under the 2026 buildout scenario for both analysis periods. Given the 45-mph posted speed and higher traffic volumes, a northbound turn lane is recommended at this access.
9. Right-turn lane warrants are not met at either proposed site access intersection on SW Norwood Road for either peak hour under the 2026 buildout scenario for any analysis period. The warrant is initially met at the site access opposite SW 89th Avenue at SW Norwood Road under 2024 Buildout conditions; however, the lane is not needed once the site access at SW Boones Ferry Road is opened. Therefore, no right-turn lane is recommended.
10. Traffic signal warrants are not met at any unsignalized intersection in the study area under either buildout scenario for any analysis period.
11. Three intersections show operational results that do not meet standards under at least one scenario:
 - o The intersection of SW Boones Ferry Road at SW Avery Street is expected to operate acceptably under all scenarios except the 2026 Buildout conditions without the Basalt Creek Parkway extension. Based on the operational analysis, which shows that construction of the Basalt Creek Parkway Extension is expected to result in improved operations, and the conservatively high estimates of forecast growth, no mitigation is recommended at this intersection.

- The intersection of SW Boones Ferry Road at SW Iowa Drive is expected to operate with LOS F conditions under all scenarios and demand is expected to exceed capacity under 2026 Buildout conditions during the morning peak hour. Since signal warrants are not met and field observations show that delays are lower because the eastbound approach operates with a separate right-turn lane during congested conditions, no mitigation is recommended. However, the City could consider striping separate left- and right-turn lanes on the eastbound approach to formalize the lane configuration.
- The intersection of the I-5 Southbound Off-Ramp at SW Elligsen Road is expected to operate with a v/c ratio that exceeds the OHP mobility target of 0.85 for freeway ramps for the morning peak hour for the existing condition and all subsequent scenarios. The 2018 RTP includes Project 11489 in the financially-constrained list, which would construct a second right-turn lane on the exit ramp. With this improvement, the ramps would operate well below the 0.85 mobility target. Although the RTP project acknowledges that conditions are currently congested, the time period for the improvement is identified as 2028-2040. Since the planned improvements for the interchange are part of the financially-constrained RTP and the contributing volumes and impact of the proposed development is relatively small, no project mitigation is recommended for this intersection.
- All other study area intersections are projected to operate acceptably per each applicable performance standard under all analysis scenarios; no other mitigation is recommended.
- Storage recommendations for the site access intersection at SW Boones Ferry Road include:
 - Maximum queues were estimated at two vehicles or 50 feet for the southbound left, which can easily be accommodated in the existing center refuge lane. The recommended striping for the southbound left-turn lane should include 100 feet of storage and the appropriate deceleration for the 45-mph posted speed.
 - The northbound left will rarely have a queue since frontage road to the west will only serve a few homes. This lane is recommended to be striped as a two-way, left-turn lane to allow for a two-stage westbound left-turn movement from the site access.
 - Maximum queues were estimated at six vehicles or 150 feet for the westbound left-movement with a two-lane approach for the site access. These queues will not affect the closest public street connection ("M" Street) to the east.



Appendix A – Site Data

Site Plan

Trip Generation



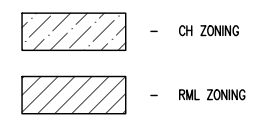
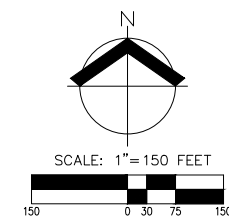
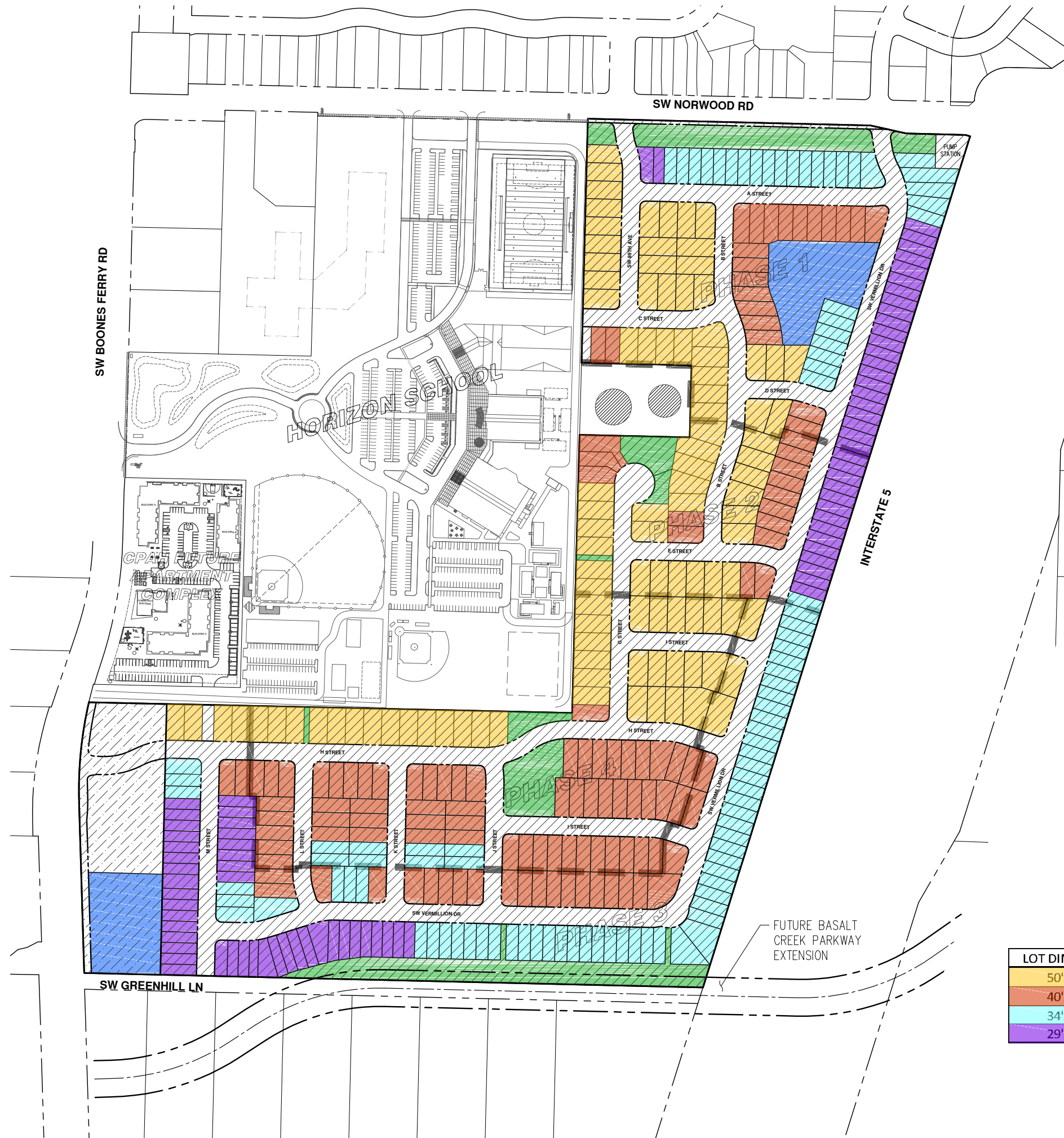

DENSITY CALCULATIONS

RML ZONE	SQ. FT.	ACRES
GROSS SITE AREA:	± 2,688,206	± 61.71
PUBLIC R.O.W. DEDICATION AREA:	± 629,282	± 14.45
CITY RESERVOIR DEDICATION OPEN SPACE AREA:	± 12,879	± 0.30
PRIVATE STREET/ACCESS AREA:	± 5,718	± 0.13
STORMWATER FACILITY AREA:	± 155,691	± 3.57
COMMERCIAL AREA:	± 87,960	± 2.02
PUMP STATION DEDICATION AREA:	± 7,709	± 0.18
NET DEVELOPABLE:	± 1,788,967	± 41.07
AUTUMN SUNRISE SUBDIVISION		
MAXIMUM DENSITY (10 DU PER ACRE)	411 LOTS	
MINIMUM DENSITY (7 DU PER ACRE)	287 LOTS	
REQUIRED OPEN SPACE AREA (9% GROSS):	± 134,410 SQ. FT.	
OPEN SPACE PROVIDED:	± 168,629 SQ. FT.	
PLANNED DENSITY:	400 LOTS	
AVERAGE LOT AREA (ALL DU):	± 4,151 SQ. FT.	
AVERAGE LOT AREA FOR SF DETACHED DU	± 4,411 SQ. FT.	
AVERAGE LOT AREA FOR SF ATTACHED DU	± 3,109 SQ. FT.	
MAXIMUM LOT SIZE	± 7,731 SQ. FT.	
MINIMUM LOT SIZE	± 2,546 SQ. FT.	

LOT DIMENSION	HOUSE TYPE	PH-1	PH-2	PH-3	PH-4	TOTAL UNITS
50'x100'	Detached	35	25	7	35	102
40'x100'	Detached	21	15	25	60	121
34'x100'	Detached	29	1	59	8	97
29'x100'	Attached	24	14	42	-	80

TOTAL UNITS	109	55	133	103	400
-------------	-----	----	-----	-----	-----



TRIP GENERATION CALCULATIONS

Land Use: Single-Family Detached Housing

Land Use Code: 210

Setting/Location: General Urban/Suburban

Variable: Dwelling Units

Variable Value: 320

AM PEAK HOUR

Trip Equation: $T = 0.71(X) + 4.80$

	Enter	Exit	Total
Directional Distribution	25%	75%	
Trip Ends	58	174	232

PM PEAK HOUR

Trip Equation: $\ln(T) = 0.96\ln(X) + 0.20$

	Enter	Exit	Total
Directional Distribution	63%	37%	
Trip Ends	195	115	310

WEEKDAY

Trip Equation: $\ln(T) = 0.92\ln(X) + 2.71$

	Enter	Exit	Total
Directional Distribution	50%	50%	
Trip Ends	1,516	1,516	3,032

SATURDAY

Trip Equation: $\ln(T) = 0.94\ln(X) + 2.56$

	Enter	Exit	Total
Directional Distribution	50%	50%	
Trip Ends	1,464	1,464	2,928



TRIP GENERATION CALCULATIONS

Land Use: Multifamily Housing (Low-Rise)

Land Use Code: 220

Setting/Location: General Urban/Suburban

Variable: Dwelling Units

Variable Value: 80

AM PEAK HOUR

Trip Equation: $\ln(T) = 0.95\ln(X) - 0.51$

	Enter	Exit	Total
Directional Distribution	23%	77%	
Trip Ends	9	30	39

PM PEAK HOUR

Trip Equation: $\ln(T) = 0.89\ln(X) - 0.02$

	Enter	Exit	Total
Directional Distribution	63%	37%	
Trip Ends	30	18	48

WEEKDAY

Trip Equation: $T = 7.56(X) - 40.86$

	Enter	Exit	Total
Directional Distribution	50%	50%	
Trip Ends	282	282	564

SATURDAY

Trip Equation: $T = 14.01(X) - 521.69$

	Enter	Exit	Total
Directional Distribution	50%	50%	
Trip Ends	300	300	600

Appendix B – Traffic Counts

Traffic Counts

In Process Traffic





(303) 216-2439
www.alltrafficdata.net

Location: 1 SW Boones Ferry Rd & SW Sagert St AM

Date: Thursday, May 6, 2021

Peak Hour: 07:30 AM - 08:30 AM

Peak 15-Minutes: 07:50 AM - 08:05 AM

Peak Hour

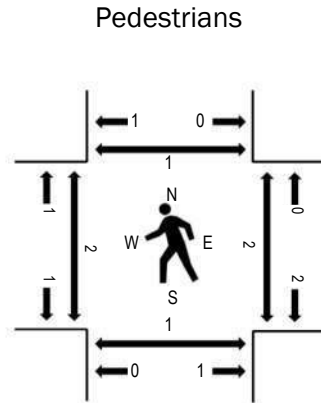
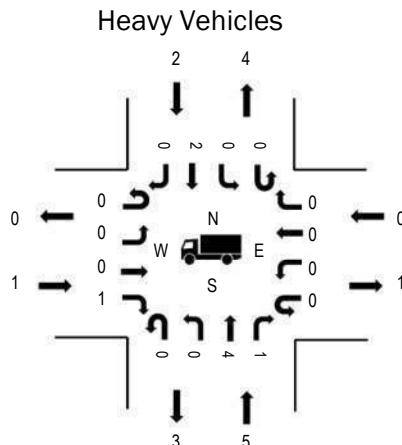
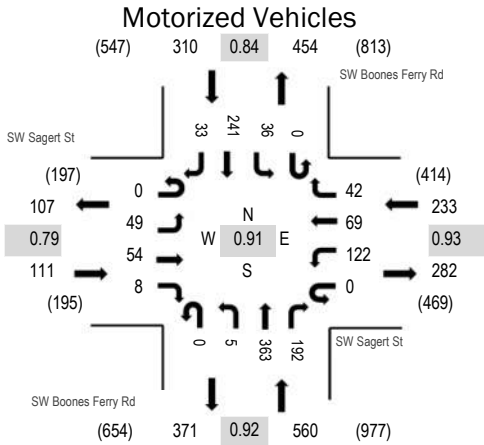

Note: Total study counts contained in parentheses.

	HV%	PHF
EB	0.9%	0.79
WB	0.0%	0.93
NB	0.9%	0.92
SB	0.6%	0.84
All	0.7%	0.91

Traffic Counts - Motorized Vehicles

Interval Start Time	SW Sagert St Eastbound				SW Sagert St Westbound				SW Boones Ferry Rd Northbound				SW Boones Ferry Rd Southbound				Total	Rolling Hour
	U-Turn	Left	Thru	Right	U-Turn	Left	Thru	Right	U-Turn	Left	Thru	Right	U-Turn	Left	Thru	Right		
7:00 AM	0	4	2	0	0	5	4	1	0	1	25	8	0	2	10	2	64	1,008
7:05 AM	0	3	2	0	0	7	2	0	0	0	18	4	0	0	13	4	53	1,054
7:10 AM	0	4	6	0	0	5	5	1	0	0	9	8	0	2	10	1	51	1,105
7:15 AM	0	3	2	0	0	10	4	4	0	0	20	4	0	3	9	1	60	1,160
7:20 AM	0	4	1	0	0	8	5	2	0	2	25	16	0	1	16	5	85	1,189
7:25 AM	0	4	4	0	0	10	6	2	0	1	34	7	0	2	9	4	83	1,209
7:30 AM	0	5	3	0	0	6	2	6	0	1	31	3	0	3	20	0	80	1,214
7:35 AM	0	7	4	0	0	11	12	2	0	1	37	14	0	5	16	3	112	1,206
7:40 AM	0	2	2	0	0	11	2	3	0	0	34	11	0	5	23	4	97	1,201
7:45 AM	0	3	6	0	0	8	8	5	0	1	38	13	0	1	15	2	100	1,186
7:50 AM	0	5	7	3	0	11	10	4	0	0	30	14	0	2	28	5	119	1,186
7:55 AM	0	4	3	0	0	6	5	2	0	1	30	21	0	5	23	4	104	1,153
8:00 AM	0	8	6	0	0	11	10	4	0	0	23	21	0	2	24	1	110	1,125
8:05 AM	0	5	4	1	0	6	5	2	0	0	29	27	0	3	19	3	104	
8:10 AM	0	0	7	2	0	14	3	3	0	0	34	19	0	0	20	4	106	
8:15 AM	0	2	5	0	0	16	4	3	0	0	22	19	0	3	12	3	89	
8:20 AM	0	6	4	2	0	12	6	2	0	1	27	18	0	1	26	0	105	
8:25 AM	0	2	3	0	0	10	2	6	0	0	28	12	0	6	15	4	88	
8:30 AM	0	2	3	0	0	10	2	3	0	0	19	11	0	2	17	3	72	
8:35 AM	0	5	2	1	0	10	6	6	0	1	31	15	0	1	26	3	107	
8:40 AM	0	4	4	1	0	11	3	2	0	1	21	15	0	1	17	2	82	
8:45 AM	0	4	7	0	0	10	4	3	0	1	31	9	0	5	22	4	100	
8:50 AM	0	2	5	0	0	10	2	3	0	0	28	14	0	4	16	2	86	
8:55 AM	0	1	4	0	0	7	5	3	0	0	28	10	0	1	13	4	76	
Count Total	0	89	96	10	0	225	117	72	0	12	652	313	0	60	419	68	2,133	
Peak Hour	0	49	54	8	0	122	69	42	0	5	363	192	0	36	241	33	1,214	

Traffic Counts - Heavy Vehicles, Bicycles on Road, and Pedestrians/Bicycles on Crosswalk

Interval Start Time	Heavy Vehicles					Interval Start Time	Bicycles on Roadway					Interval Start Time	Pedestrians/Bicycles on Crosswalk				
	EB	NB	WB	SB	Total		EB	NB	WB	SB	Total		EB	NB	WB	SB	Total
7:00 AM	0	1	0	0	1	7:00 AM	0	0	0	0	0	7:00 AM	0	0	0	1	1
7:05 AM	0	0	0	0	0	7:05 AM	0	0	0	0	0	7:05 AM	0	0	0	3	3
7:10 AM	0	0	0	0	0	7:10 AM	0	0	1	0	1	7:10 AM	0	0	0	0	0
7:15 AM	0	0	0	0	0	7:15 AM	0	0	0	0	0	7:15 AM	0	0	0	3	3
7:20 AM	0	0	0	0	0	7:20 AM	0	0	0	0	0	7:20 AM	0	0	0	1	1
7:25 AM	0	0	0	0	0	7:25 AM	0	0	0	0	0	7:25 AM	0	0	0	0	0
7:30 AM	0	0	0	0	0	7:30 AM	0	0	0	0	0	7:30 AM	0	0	0	0	0
7:35 AM	0	1	0	0	1	7:35 AM	0	0	0	0	0	7:35 AM	0	1	1	0	2
7:40 AM	0	0	0	1	1	7:40 AM	0	0	0	0	0	7:40 AM	0	0	0	0	0
7:45 AM	0	1	0	0	1	7:45 AM	0	0	0	0	0	7:45 AM	0	0	0	0	0
7:50 AM	0	1	0	1	2	7:50 AM	0	0	0	0	0	7:50 AM	1	0	0	0	1
7:55 AM	0	0	0	0	0	7:55 AM	0	0	0	0	0	7:55 AM	0	0	0	1	1
8:00 AM	0	2	0	0	2	8:00 AM	0	0	0	0	0	8:00 AM	0	0	0	0	0
8:05 AM	0	0	0	0	0	8:05 AM	0	0	0	0	0	8:05 AM	0	0	0	0	0
8:10 AM	1	0	0	0	1	8:10 AM	0	1	0	0	1	8:10 AM	1	0	0	0	1
8:15 AM	0	0	0	0	0	8:15 AM	0	0	0	0	0	8:15 AM	0	0	0	0	0
8:20 AM	0	0	0	0	0	8:20 AM	0	0	0	1	1	8:20 AM	0	0	1	0	1
8:25 AM	0	0	0	0	0	8:25 AM	0	0	0	0	0	8:25 AM	0	0	0	0	0
8:30 AM	0	0	0	1	1	8:30 AM	0	0	0	0	0	8:30 AM	0	0	0	0	0
8:35 AM	0	0	0	0	0	8:35 AM	0	0	0	0	0	8:35 AM	0	0	0	1	1
8:40 AM	0	0	0	0	0	8:40 AM	0	0	0	0	0	8:40 AM	0	0	0	0	0
8:45 AM	0	1	0	0	1	8:45 AM	0	0	0	0	0	8:45 AM	0	0	0	0	0
8:50 AM	0	0	0	0	0	8:50 AM	0	0	0	0	0	8:50 AM	0	0	0	0	0
8:55 AM	0	0	0	0	0	8:55 AM	0	0	0	0	0	8:55 AM	0	2	0	0	2
Count Total	1	7	0	3	11	Count Total	0	1	1	1	3	Count Total	2	3	2	10	17
Peak Hour	1	5	0	2	8	Peak Hour	0	1	0	1	2	Peak Hour	2	1	2	1	6

LOCATION: SW Boones Ferry Rd -- SW Avery St
CITY/STATE: Washington, OR

QC JOB #: 15109507
DATE: Tue, Oct 29 2019

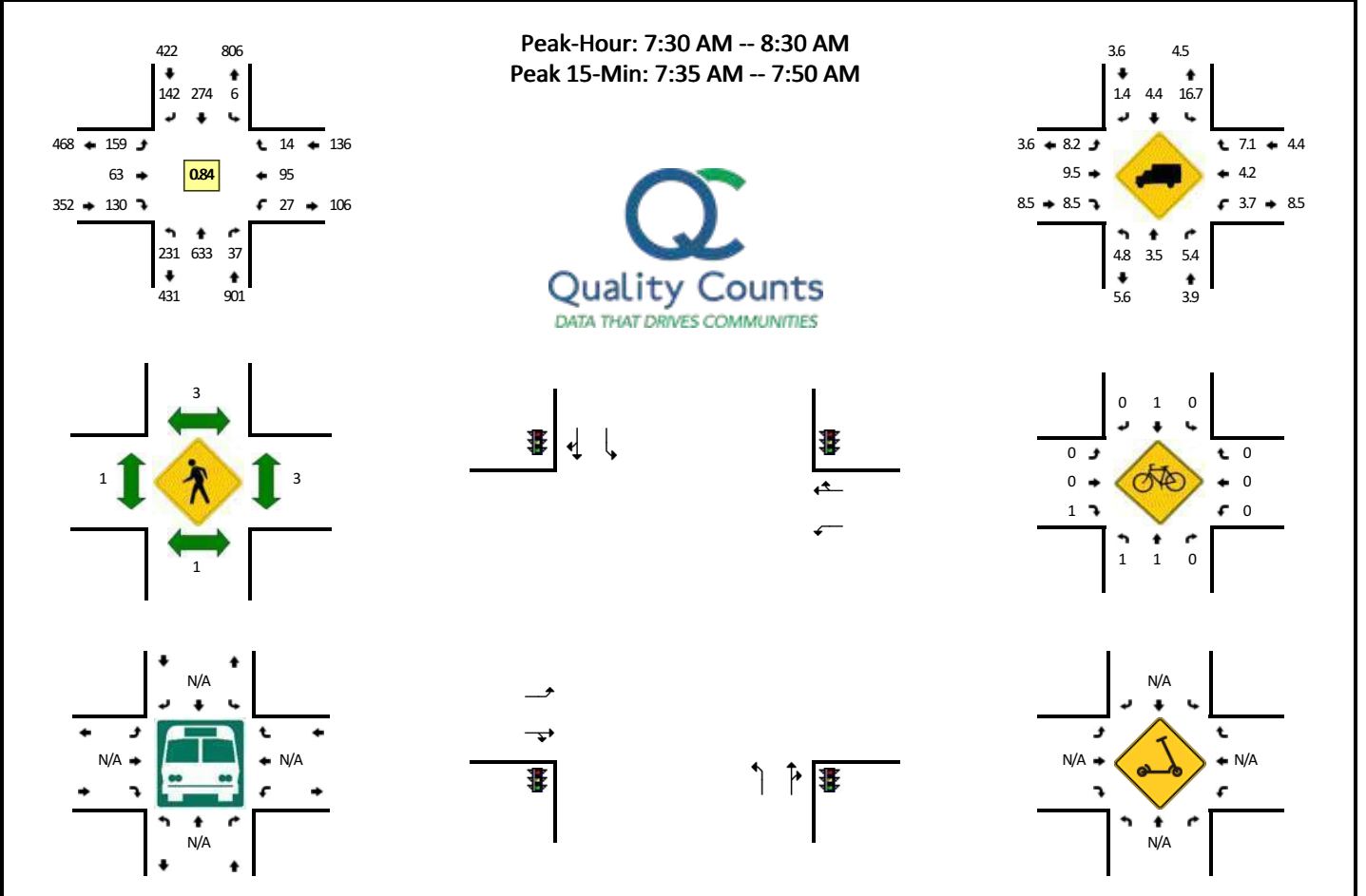

5-Min Count Period Beginning At	SW Boones Ferry Rd (Northbound)				SW Boones Ferry Rd (Southbound)				SW Avery St (Eastbound)				SW Avery St (Westbound)				Total	Hourly Totals
	Left	Thru	Right	U	Left	Thru	Right	U	Left	Thru	Right	U	Left	Thru	Right	U		
7:30 AM	20	52	1	0	0	27	16	0	16	3	5	0	2	7	2	0	151	
7:35 AM	32	59	1	0	0	21	20	0	18	7	15	0	2	13	0	0	188	
7:40 AM	23	45	3	0	3	23	9	0	17	5	19	0	3	8	4	0	162	
7:45 AM	17	63	3	0	0	34	22	0	15	3	16	0	6	7	0	0	186	
7:50 AM	20	47	0	0	0	28	9	0	12	4	11	0	2	14	2	0	149	
7:55 AM	22	65	2	0	0	26	14	0	6	4	14	0	5	10	0	0	168	
8:00 AM	16	55	2	0	1	24	9	0	17	11	9	0	1	12	3	0	160	
8:05 AM	13	52	8	0	0	17	12	0	12	10	13	0	2	8	1	0	148	
8:10 AM	13	69	6	0	0	12	10	0	15	4	4	0	1	5	1	0	140	
8:15 AM	21	53	7	0	2	15	7	0	13	9	7	0	1	4	0	0	139	
8:20 AM	16	42	3	0	0	25	8	0	11	0	11	0	1	4	0	0	121	
8:25 AM	18	31	1	0	0	22	6	0	7	3	6	0	1	3	1	0	99	1811
Peak 15-Min Flowrates	Northbound				Southbound				Eastbound				Westbound				Total	
	Left	Thru	Right	U	Left	Thru	Right	U	Left	Thru	Right	U	Left	Thru	Right	U		
All Vehicles	288	668	28	0	12	312	204	0	200	60	200	0	44	112	16	0	2144	
Heavy Trucks	8	20	0	0	4	8	0	0	4	20	16	0	4	4	0	0	88	
Buses																		
Pedestrians	0	0	0	0	0	4	0	0	0	4	0	0	0	4	0	0	12	
Bicycles																		
Scoters																		

Comments:

LOCATION: SW Boones Ferry Rd -- SW Ibach St
CITY/STATE: Tualatin, OR

QC JOB #: 14391101
DATE: Thu, Apr 27 2017

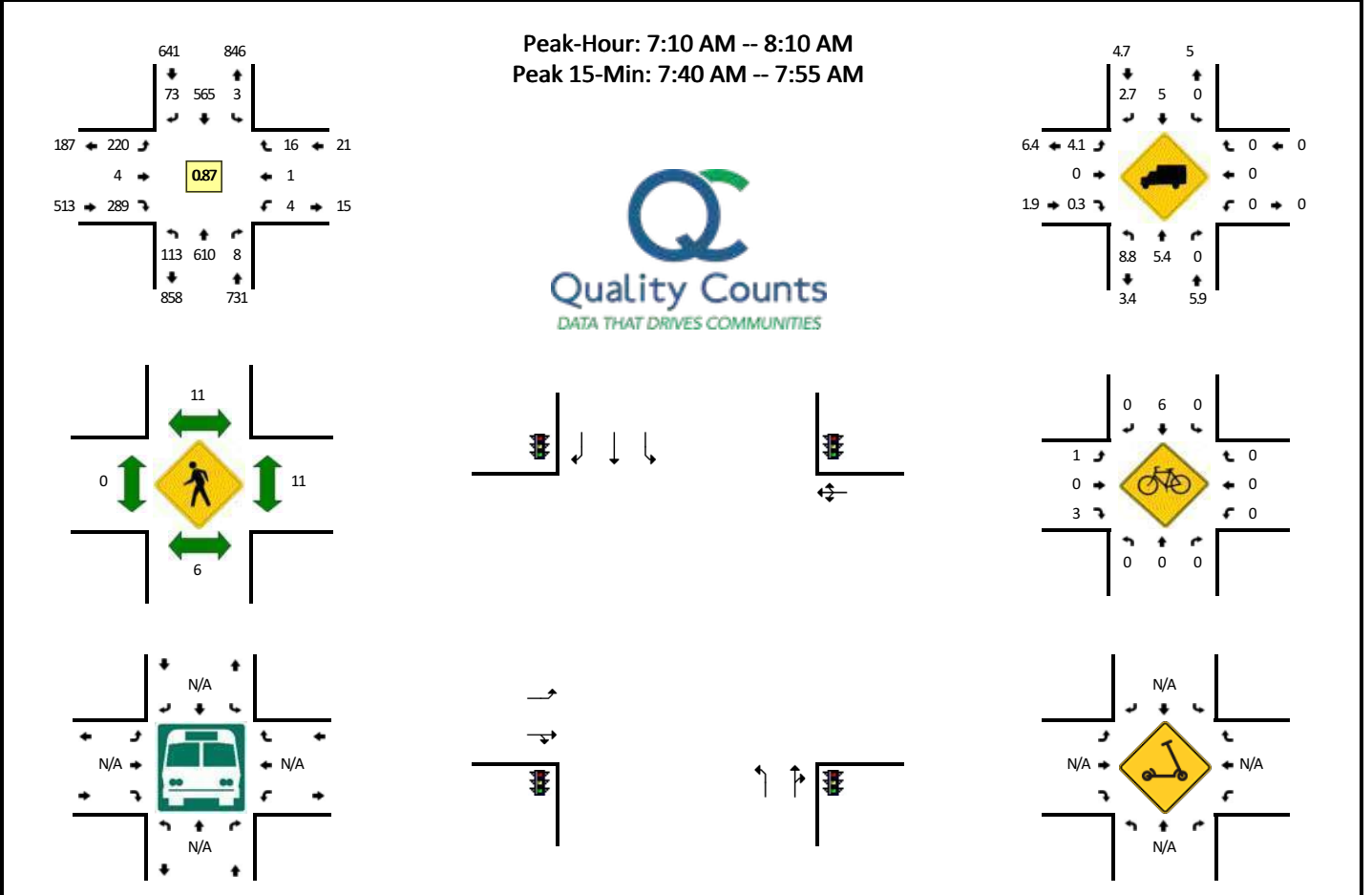

5-Min Count Period Beginning At	SW Boones Ferry Rd (Northbound)				SW Boones Ferry Rd (Southbound)				SW Ibach St (Eastbound)				SW Ibach St (Westbound)				Total	Hourly Totals
	Left	Thru	Right	U	Left	Thru	Right	U	Left	Thru	Right	U	Left	Thru	Right	U		
7:00 AM	5	47	1	0	0	18	2	0	23	0	8	0	1	0	0	0	105	
7:05 AM	3	44	0	0	0	23	4	0	25	0	4	0	0	0	0	0	103	
7:10 AM	2	54	0	0	1	30	3	0	14	0	9	0	2	0	2	0	117	
7:15 AM	8	57	1	0	1	39	3	0	20	0	15	0	1	0	0	0	145	
7:20 AM	7	53	0	0	0	46	5	0	19	0	17	0	0	0	4	0	151	
7:25 AM	5	58	0	0	0	46	4	0	22	0	19	0	0	0	0	0	154	
7:30 AM	8	44	1	0	0	44	8	0	10	1	15	0	0	0	1	0	132	
7:35 AM	6	56	0	0	0	42	6	0	22	0	27	0	0	0	1	0	160	
7:40 AM	14	59	0	0	0	53	5	0	23	0	31	0	0	0	0	0	185	
7:45 AM	16	52	2	0	0	47	4	0	17	1	30	0	0	0	1	0	170	
7:50 AM	7	42	0	0	0	69	3	0	29	1	40	0	1	0	1	0	193	
7:55 AM	14	44	2	0	0	54	11	0	16	0	38	0	0	1	2	0	182	1797
8:00 AM	14	43	1	0	1	50	5	0	14	0	30	0	0	0	2	0	160	1852
8:05 AM	12	48	1	0	0	45	16	0	14	1	18	0	0	0	2	0	157	1906
8:10 AM	4	39	0	0	0	35	16	0	18	0	3	0	0	0	1	0	116	1905
8:15 AM	3	33	0	0	0	33	5	0	17	0	5	0	0	0	0	0	96	1856
8:20 AM	8	43	2	0	0	30	7	0	19	1	6	0	0	0	0	0	116	1821
8:25 AM	7	29	0	0	0	27	9	0	16	1	6	0	0	2	0	0	97	1764
8:30 AM	2	35	0	0	0	25	5	0	8	0	6	0	0	0	0	0	81	1713
8:35 AM	4	22	1	0	0	22	4	0	17	0	3	0	0	0	0	0	73	1626
8:40 AM	5	26	0	0	0	30	12	0	16	0	8	0	0	0	0	0	97	1538
8:45 AM	3	33	0	0	1	15	4	0	21	0	5	0	0	0	1	0	83	1451
8:50 AM	5	24	0	0	0	16	4	0	17	0	6	0	1	0	1	0	74	1332
8:55 AM	7	22	0	0	0	22	7	0	16	0	4	0	0	0	0	0	78	1228
Peak 15-Min Flowrates	Northbound				Southbound				Eastbound				Westbound				Total	
	Left	Thru	Right	U	Left	Thru	Right	U	Left	Thru	Right	U	Left	Thru	Right	U		
All Vehicles	148	612	8	0	0	676	48	0	276	8	404	0	4	0	8	0	2192	
Heavy Trucks	4	12	0	0	0	12	0	0	8	0	0	0	0	0	0	0	36	
Buses																		
Pedestrians		12				12				0				12			36	
Bicycles	0	0	0		0	8	0		0	0	4		0	0	0		12	
Scoters																		

Comments:



(303) 216-2439
www.alltrafficdata.net

Location: 2 SW BOONES FERRY RD & SW IOWA ST AM

Date: Tuesday, September 29, 2020

Peak Hour: 07:15 AM - 08:15 AM

Peak 15-Minutes: 07:40 AM - 07:55 AM

Peak Hour

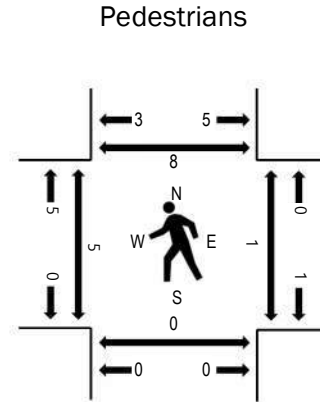
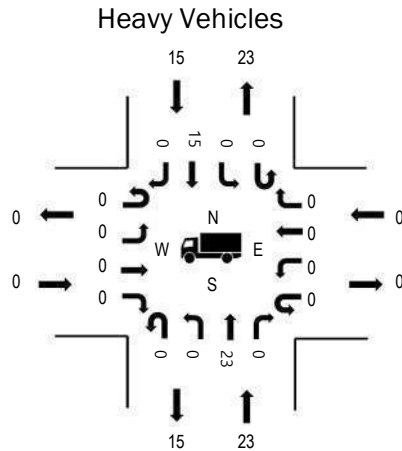
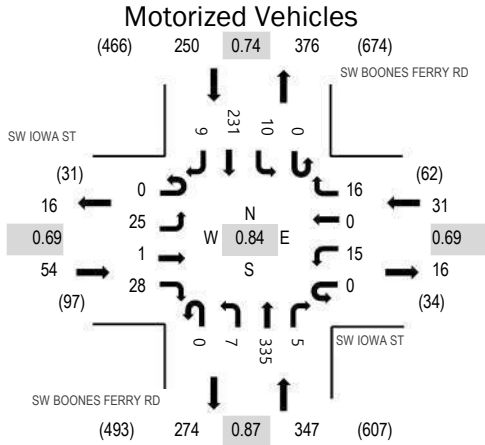

Note: Total study counts contained in parentheses.

	HV%	PHF
EB	0.0%	0.69
WB	0.0%	0.69
NB	6.6%	0.87
SB	6.0%	0.74
All	5.6%	0.84

Traffic Counts - Motorized Vehicles

Interval Start Time	SW IOWA ST Eastbound				SW IOWA ST Westbound				SW BOONES FERRY RD Northbound				SW BOONES FERRY RD Southbound				Total	Rolling Hour
	U-Turn	Left	Thru	Right	U-Turn	Left	Thru	Right	U-Turn	Left	Thru	Right	U-Turn	Left	Thru	Right		
7:00 AM	0	2	0	0	0	0	0	1	0	0	30	0	0	1	17	1	52	673
7:05 AM	0	3	0	1	0	0	0	2	0	0	27	2	0	0	19	0	54	675
7:10 AM	0	2	0	0	0	0	0	0	0	0	24	0	0	0	15	0	41	670
7:15 AM	0	1	0	3	0	1	0	1	0	1	30	1	0	1	15	0	54	682
7:20 AM	0	0	0	0	0	1	0	0	0	0	25	0	0	0	20	0	46	669
7:25 AM	0	0	0	3	0	1	0	2	0	0	37	0	0	0	19	1	63	662
7:30 AM	0	2	0	3	0	1	0	2	0	1	31	1	0	1	14	0	56	640
7:35 AM	0	4	0	3	0	1	0	2	0	0	30	0	0	1	15	0	56	623
7:40 AM	0	1	1	3	0	1	0	0	0	2	33	0	0	1	23	2	67	607
7:45 AM	0	5	0	4	0	3	0	0	0	0	30	0	0	1	28	0	71	591
7:50 AM	0	3	0	1	0	1	0	4	0	0	25	0	0	1	28	1	64	575
7:55 AM	0	3	0	2	0	2	0	2	0	1	15	0	0	2	19	3	49	551
8:00 AM	0	4	0	3	0	2	0	1	0	2	24	2	0	0	15	1	54	559
8:05 AM	0	0	0	1	0	1	0	0	0	0	29	1	0	1	16	0	49	
8:10 AM	0	2	0	2	0	0	0	2	0	0	26	0	0	1	19	1	53	
8:15 AM	0	2	0	1	0	1	0	3	0	1	16	0	0	4	13	0	41	
8:20 AM	0	2	0	1	0	0	0	1	0	0	18	0	0	0	17	0	39	
8:25 AM	0	2	0	3	0	2	0	2	0	1	19	0	0	0	12	0	41	
8:30 AM	0	2	0	2	0	1	0	1	0	0	19	1	0	1	12	0	39	
8:35 AM	0	0	0	2	0	1	0	1	0	1	19	1	0	1	14	0	40	
8:40 AM	0	2	0	2	0	1	0	1	0	1	25	0	0	0	15	4	51	
8:45 AM	0	5	0	2	0	1	0	5	0	0	21	0	0	1	17	3	55	
8:50 AM	0	2	0	1	0	0	0	4	0	1	13	1	0	1	16	1	40	
8:55 AM	0	3	0	1	0	0	0	3	0	1	16	2	0	2	29	0	57	
Count Total	0	52	1	44	0	22	0	40	0	13	582	12	0	21	427	18	1,232	
Peak Hour	0	25	1	28	0	15	0	16	0	7	335	5	0	10	231	9	682	

Traffic Counts - Heavy Vehicles, Bicycles on Road, and Pedestrians/Bicycles on Crosswalk

Interval Start Time	Heavy Vehicles					Interval Start Time	Bicycles on Roadway					Interval Start Time	Pedestrians/Bicycles on Crosswalk				
	EB	NB	WB	SB	Total		EB	NB	WB	SB	Total		EB	NB	WB	SB	Total
7:00 AM	0	3	0	0	3	7:00 AM						7:00 AM	0	0	1	0	1
7:05 AM	0	1	0	0	1	7:05 AM						7:05 AM	1	0	0	0	1
7:10 AM	0	1	0	2	3	7:10 AM						7:10 AM	0	0	1	0	1
7:15 AM	0	0	0	0	0	7:15 AM						7:15 AM	0	0	1	0	1
7:20 AM	0	3	0	0	3	7:20 AM						7:20 AM	0	0	0	2	2
7:25 AM	0	0	0	0	0	7:25 AM						7:25 AM	0	0	0	1	1
7:30 AM	0	2	0	3	5	7:30 AM						7:30 AM	1	0	0	0	1
7:35 AM	0	2	0	1	3	7:35 AM						7:35 AM	0	0	0	2	2
7:40 AM	0	3	0	2	5	7:40 AM						7:40 AM	0	0	0	1	1
7:45 AM	0	1	0	2	3	7:45 AM						7:45 AM	3	0	0	0	3
7:50 AM	0	2	0	1	3	7:50 AM						7:50 AM	0	0	0	0	0
7:55 AM	0	1	0	0	1	7:55 AM						7:55 AM	0	0	0	2	2
8:00 AM	0	2	0	2	4	8:00 AM						8:00 AM	0	0	0	0	0
8:05 AM	0	2	0	1	3	8:05 AM						8:05 AM	0	0	0	0	0
8:10 AM	0	5	0	3	8	8:10 AM						8:10 AM	1	0	0	0	1
8:15 AM	0	0	0	3	3	8:15 AM						8:15 AM	0	0	0	0	0
8:20 AM	0	1	0	0	1	8:20 AM						8:20 AM	0	0	0	0	0
8:25 AM	0	1	0	0	1	8:25 AM						8:25 AM	0	0	2	0	2
8:30 AM	0	1	0	1	2	8:30 AM						8:30 AM	0	0	0	0	0
8:35 AM	0	2	0	2	4	8:35 AM						8:35 AM	0	0	0	0	0
8:40 AM	0	2	0	1	3	8:40 AM						8:40 AM	0	0	0	0	0
8:45 AM	0	1	0	2	3	8:45 AM						8:45 AM	1	0	0	1	2
8:50 AM	0	1	0	3	4	8:50 AM						8:50 AM	0	0	0	1	1
8:55 AM	0	0	0	4	4	8:55 AM						8:55 AM	0	0	0	0	0
Count Total	0	37	0	33	70	Count Total						Count Total	7	0	5	10	22
Peak Hour	0	23	0	15	38	Peak Hour						Peak Hour	5	0	1	8	14



(303) 216-2439
www.alltrafficdata.net

Location: 3 SW BOONES FERRY RD & SW NORWOOD RD AM

Date: Tuesday, September 29, 2020

Peak Hour: 07:10 AM - 08:10 AM

Peak 15-Minutes: 07:35 AM - 07:50 AM

Peak Hour

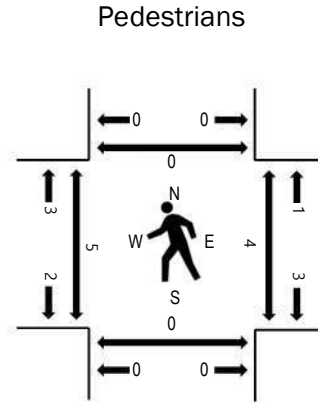
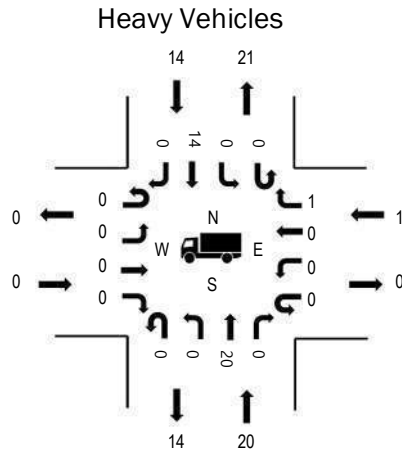
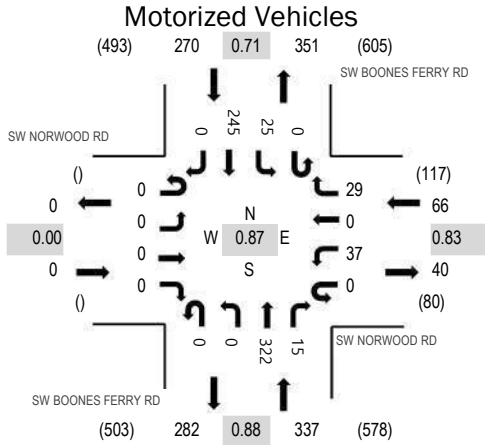

Note: Total study counts contained in parentheses.

	HV%	PHF
EB	0.0%	0.00
WB	1.5%	0.83
NB	5.9%	0.88
SB	5.2%	0.71
All	5.2%	0.87

Traffic Counts - Motorized Vehicles

Interval Start Time	SW NORWOOD RD Eastbound				SW NORWOOD RD Westbound				SW BOONES FERRY RD Northbound				SW BOONES FERRY RD Southbound				Total	Rolling Hour
	U-Turn	Left	Thru	Right	U-Turn	Left	Thru	Right	U-Turn	Left	Thru	Right	U-Turn	Left	Thru	Right		
7:00 AM	0	0	0	0	0	1	0	1	0	0	30	0	0	3	18	0	53	665
7:05 AM	0	0	0	0	0	1	0	2	0	0	24	1	0	1	14	0	43	657
7:10 AM	0	0	0	0	0	5	0	3	0	0	27	1	0	5	13	0	54	673
7:15 AM	0	0	0	0	0	1	0	3	0	0	25	0	0	3	21	0	53	665
7:20 AM	0	0	0	0	0	4	0	1	0	0	27	0	0	2	16	0	50	649
7:25 AM	0	0	0	0	0	3	0	3	0	0	34	0	0	1	20	0	61	637
7:30 AM	0	0	0	0	0	5	0	1	0	0	27	2	0	1	18	0	54	618
7:35 AM	0	0	0	0	0	1	0	4	0	0	32	1	0	2	17	0	57	603
7:40 AM	0	0	0	0	0	7	0	2	0	0	26	2	0	2	31	0	70	582
7:45 AM	0	0	0	0	0	1	0	2	0	0	29	3	0	1	31	0	67	568
7:50 AM	0	0	0	0	0	2	0	3	0	0	18	1	0	3	28	0	55	538
7:55 AM	0	0	0	0	0	2	0	2	0	0	24	0	0	3	17	0	48	521
8:00 AM	0	0	0	0	0	2	0	2	0	0	18	3	0	2	18	0	45	523
8:05 AM	0	0	0	0	0	4	0	3	0	0	35	2	0	0	15	0	59	
8:10 AM	0	0	0	0	0	2	0	4	0	0	16	2	0	2	20	0	46	
8:15 AM	0	0	0	0	0	3	0	2	0	0	11	3	0	1	17	0	37	
8:20 AM	0	0	0	0	0	3	0	2	0	0	19	0	0	4	10	0	38	
8:25 AM	0	0	0	0	0	3	0	4	0	0	19	1	0	1	14	0	42	
8:30 AM	0	0	0	0	0	2	0	3	0	0	14	2	0	2	16	0	39	
8:35 AM	0	0	0	0	0	1	0	3	0	0	14	1	0	3	14	0	36	
8:40 AM	0	0	0	0	0	2	0	3	0	0	29	2	0	1	19	0	56	
8:45 AM	0	0	0	0	0	1	0	0	0	0	18	2	0	1	15	0	37	
8:50 AM	0	0	0	0	0	2	0	3	0	0	14	2	0	2	15	0	38	
8:55 AM	0	0	0	0	0	1	0	2	0	0	17	0	0	3	27	0	50	
Count Total	0	0	0	0	0	59	0	58	0	0	547	31	0	49	444	0	1,188	
Peak Hour	0	0	0	0	0	37	0	29	0	0	322	15	0	25	245	0	673	

Traffic Counts - Heavy Vehicles, Bicycles on Road, and Pedestrians/Bicycles on Crosswalk

Interval Start Time	Heavy Vehicles					Interval Start Time	Bicycles on Roadway					Interval Start Time	Pedestrians/Bicycles on Crosswalk				
	EB	NB	WB	SB	Total		EB	NB	WB	SB	Total		EB	NB	WB	SB	Total
7:00 AM	0	2	1	0	3	7:00 AM						7:00 AM	1	0	0	0	1
7:05 AM	0	1	0	0	1	7:05 AM						7:05 AM	0	0	0	0	0
7:10 AM	0	1	0	2	3	7:10 AM						7:10 AM	0	0	0	0	0
7:15 AM	0	0	0	0	0	7:15 AM						7:15 AM	0	0	1	0	1
7:20 AM	0	1	1	0	2	7:20 AM						7:20 AM	0	0	0	0	0
7:25 AM	0	1	0	1	2	7:25 AM						7:25 AM	1	0	0	0	1
7:30 AM	0	1	0	2	3	7:30 AM						7:30 AM	1	0	0	0	1
7:35 AM	0	3	0	2	5	7:35 AM						7:35 AM	1	0	1	0	2
7:40 AM	0	2	0	2	4	7:40 AM						7:40 AM	1	0	1	0	2
7:45 AM	0	1	0	2	3	7:45 AM						7:45 AM	0	0	1	0	1
7:50 AM	0	2	0	0	2	7:50 AM						7:50 AM	0	0	0	0	0
7:55 AM	0	3	0	1	4	7:55 AM						7:55 AM	0	0	0	0	0
8:00 AM	0	2	0	1	3	8:00 AM						8:00 AM	0	0	0	0	0
8:05 AM	0	3	0	1	4	8:05 AM						8:05 AM	1	0	0	0	1
8:10 AM	0	3	0	3	6	8:10 AM						8:10 AM	0	0	0	0	0
8:15 AM	0	0	0	3	3	8:15 AM						8:15 AM	0	0	0	0	0
8:20 AM	0	2	0	0	2	8:20 AM						8:20 AM	0	0	0	0	0
8:25 AM	0	1	0	0	1	8:25 AM						8:25 AM	2	0	1	0	3
8:30 AM	0	1	0	2	3	8:30 AM						8:30 AM	0	0	0	0	0
8:35 AM	0	1	1	1	3	8:35 AM						8:35 AM	0	0	0	0	0
8:40 AM	0	1	0	1	2	8:40 AM						8:40 AM	0	0	0	0	0
8:45 AM	0	1	0	2	3	8:45 AM						8:45 AM	1	0	0	0	1
8:50 AM	0	1	0	3	4	8:50 AM						8:50 AM	0	0	0	0	0
8:55 AM	0	0	0	4	4	8:55 AM						8:55 AM	0	0	0	0	0
Count Total	0	34	3	33	70	Count Total						Count Total	9	0	5	0	14
Peak Hour	0	20	1	14	35	Peak Hour						Peak Hour	5	0	4	0	9



(303) 216-2439

www.alltrafficdata.net

Location: 1 SW BOONES FERRY RD & SW DAY RD AM

Date: Tuesday, March 30, 2021

Peak Hour: 08:00 AM - 09:00 AM

Peak 15-Minutes: 08:20 AM - 08:35 AM

Peak Hour

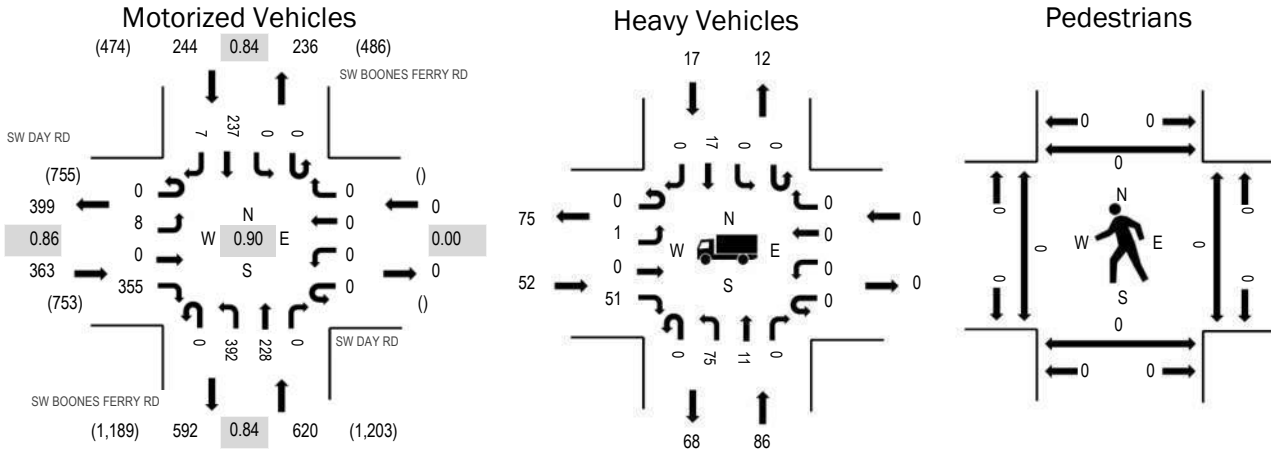

Note: Total study counts contained in parentheses.

	HV%	PHF
EB	14.3%	0.86
WB	0.0%	0.00
NB	13.9%	0.84
SB	7.0%	0.84
All	12.6%	0.90

Traffic Counts - Motorized Vehicles

Interval Start Time	SW DAY RD Eastbound				SW DAY RD Westbound				SW BOONES FERRY RD Northbound				SW BOONES FERRY RD Southbound				Total	Rolling Hour
	U-Turn	Left	Thru	Right	U-Turn	Left	Thru	Right	U-Turn	Left	Thru	Right	U-Turn	Left	Thru	Right		
7:00 AM	0	2	0	34	0	0	0	0	0	33	22	0	0	0	21	1	113	1,203
7:05 AM	0	3	0	31	0	0	0	0	0	16	15	0	0	0	18	4	87	1,183
7:10 AM	0	2	0	29	0	0	0	0	0	42	23	0	0	0	22	1	119	1,179
7:15 AM	0	1	0	29	0	0	0	0	0	28	21	0	0	0	24	1	104	1,154
7:20 AM	0	0	0	24	0	0	0	0	0	21	23	0	0	0	20	4	92	1,135
7:25 AM	0	0	0	32	0	0	0	0	0	21	17	0	0	0	12	0	82	1,170
7:30 AM	0	0	0	33	0	0	0	0	0	34	34	0	0	0	25	1	127	1,197
7:35 AM	0	0	0	32	0	0	0	0	0	21	19	0	0	0	9	0	81	1,176
7:40 AM	0	1	0	36	0	0	0	0	0	35	23	0	0	0	16	1	112	1,210
7:45 AM	0	0	0	42	0	0	0	0	0	31	15	0	0	0	18	0	106	1,204
7:50 AM	0	0	0	34	0	0	0	0	0	24	18	0	0	0	21	0	97	1,212
7:55 AM	0	0	0	25	0	0	0	0	0	36	11	0	0	0	10	1	83	1,196
8:00 AM	0	0	0	30	0	0	0	0	0	27	20	0	0	0	16	0	93	1,227
8:05 AM	0	1	0	20	0	0	0	0	0	37	14	0	0	0	11	0	83	
8:10 AM	0	1	0	29	0	0	0	0	0	34	12	0	0	0	18	0	94	
8:15 AM	0	0	0	20	0	0	0	0	0	22	16	0	0	0	26	1	85	
8:20 AM	0	0	0	35	0	0	0	0	0	56	14	0	0	0	22	0	127	
8:25 AM	0	2	0	29	0	0	0	0	0	32	24	0	0	0	21	1	109	
8:30 AM	0	1	0	22	0	0	0	0	0	29	29	0	0	0	24	1	106	
8:35 AM	0	0	0	39	0	0	0	0	0	26	24	0	0	0	26	0	115	
8:40 AM	0	0	0	30	0	0	0	0	0	30	24	0	0	0	20	2	106	
8:45 AM	0	1	0	37	0	0	0	0	0	38	21	0	0	0	17	0	114	
8:50 AM	0	0	0	27	0	0	0	0	0	27	14	0	0	0	13	0	81	
8:55 AM	0	2	0	37	0	0	0	0	0	34	16	0	0	0	23	2	114	
Count Total	0	17	0	736	0	0	0	0	0	734	469	0	0	0	453	21	2,430	
Peak Hour	0	8	0	355	0	0	0	0	0	392	228	0	0	0	237	7	1,227	

Traffic Counts - Heavy Vehicles, Bicycles on Road, and Pedestrians/Bicycles on Crosswalk

Interval Start Time	Heavy Vehicles					Interval Start Time	Bicycles on Roadway					Interval Start Time	Pedestrians/Bicycles on Crosswalk				
	EB	NB	WB	SB	Total		EB	NB	WB	SB	Total		EB	NB	WB	SB	Total
7:00 AM	8	4	0	3	15	7:00 AM	0	0	0	0	0	7:00 AM	0	0	0	0	0
7:05 AM	7	2	0	1	10	7:05 AM	0	0	0	0	0	7:05 AM	0	0	0	0	0
7:10 AM	2	6	0	1	9	7:10 AM	0	0	0	0	0	7:10 AM	0	0	0	0	0
7:15 AM	5	2	0	0	7	7:15 AM	0	0	0	0	0	7:15 AM	0	0	0	0	0
7:20 AM	3	5	0	3	11	7:20 AM	0	0	0	0	0	7:20 AM	0	0	0	0	0
7:25 AM	6	4	0	0	10	7:25 AM	0	0	0	0	0	7:25 AM	0	0	0	0	0
7:30 AM	5	11	0	2	18	7:30 AM	0	0	0	0	0	7:30 AM	0	0	0	0	0
7:35 AM	6	7	0	0	13	7:35 AM	0	0	0	0	0	7:35 AM	0	0	0	0	0
7:40 AM	3	7	0	0	10	7:40 AM	0	0	0	0	0	7:40 AM	0	0	0	0	0
7:45 AM	10	8	0	0	18	7:45 AM	0	0	0	0	0	7:45 AM	0	0	0	0	0
7:50 AM	7	2	0	2	11	7:50 AM	0	0	0	0	0	7:50 AM	0	0	0	0	0
7:55 AM	2	3	0	1	6	7:55 AM	0	0	0	0	0	7:55 AM	0	0	0	0	0
8:00 AM	5	5	0	2	12	8:00 AM	0	0	0	0	0	8:00 AM	0	0	0	0	0
8:05 AM	2	2	0	3	7	8:05 AM	0	0	0	0	0	8:05 AM	0	0	0	0	0
8:10 AM	5	6	0	2	13	8:10 AM	0	0	0	0	0	8:10 AM	0	0	0	0	0
8:15 AM	2	7	0	2	11	8:15 AM	0	0	0	0	0	8:15 AM	0	0	0	0	0
8:20 AM	7	9	0	1	17	8:20 AM	0	0	0	0	0	8:20 AM	0	0	0	0	0
8:25 AM	6	15	0	1	22	8:25 AM	0	0	0	0	0	8:25 AM	0	0	0	0	0
8:30 AM	4	9	0	3	16	8:30 AM	0	0	0	0	0	8:30 AM	0	0	0	0	0
8:35 AM	1	6	0	1	8	8:35 AM	0	0	0	0	0	8:35 AM	0	0	0	0	0
8:40 AM	2	1	0	0	3	8:40 AM	0	0	0	0	0	8:40 AM	0	0	0	0	0
8:45 AM	6	7	0	2	15	8:45 AM	0	0	0	0	0	8:45 AM	0	0	0	0	0
8:50 AM	8	10	0	0	18	8:50 AM	0	0	0	0	0	8:50 AM	0	0	0	0	0
8:55 AM	4	9	0	0	13	8:55 AM	0	0	0	0	0	8:55 AM	0	0	0	0	0
Count Total	116	147	0	30	293	Count Total	0	0	0	0	0	Count Total	0	0	0	0	0
Peak Hour	52	86	0	17	155	Peak Hour	0	0	0	0	0	Peak Hour	0	0	0	0	0



(303) 216-2439
www.alltrafficdata.net

Location: SW Boones Ferry Rd & SW 95th Ave AM

Date: Tuesday, June 8, 2021

Peak Hour: 07:20 AM - 08:20 AM

Peak 15-Minutes: 07:40 AM - 07:55 AM

Peak Hour

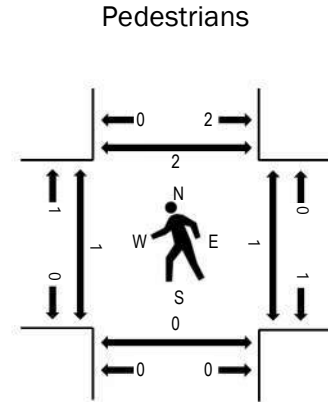
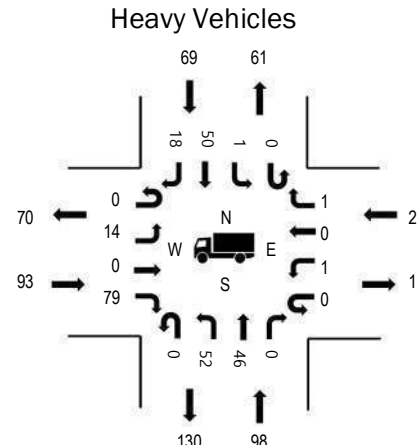
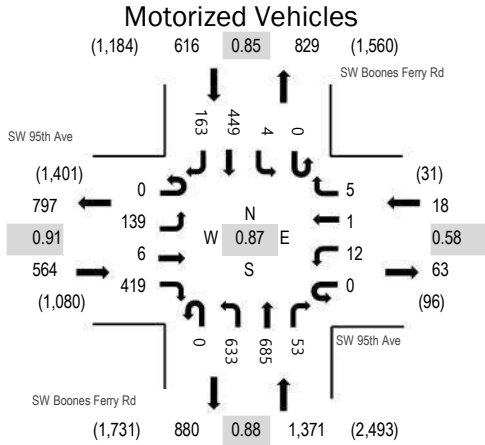

Note: Total study counts contained in parentheses.

	HV%	PHF
EB	16.5%	0.91
WB	11.1%	0.58
NB	7.1%	0.88
SB	11.2%	0.85
All	10.2%	0.87

Traffic Counts - Motorized Vehicles

Interval Start Time	SW 95th Ave Eastbound				SW 95th Ave Westbound				SW Boones Ferry Rd Northbound				SW Boones Ferry Rd Southbound				Total	Rolling Hour
	U-Turn	Left	Thru	Right	U-Turn	Left	Thru	Right	U-Turn	Left	Thru	Right	U-Turn	Left	Thru	Right		
7:00 AM	0	21	0	30	0	0	0	0	0	39	63	2	0	0	31	8	194	2,552
7:05 AM	0	12	0	32	0	0	0	0	0	32	57	2	0	0	44	8	187	2,566
7:10 AM	0	10	0	32	0	0	0	0	0	44	36	3	0	0	42	12	179	2,561
7:15 AM	0	4	1	41	0	0	1	0	0	47	39	2	0	0	37	7	179	2,553
7:20 AM	0	11	1	38	0	0	0	0	0	56	62	3	0	0	39	14	224	2,569
7:25 AM	0	13	0	34	0	0	0	0	0	50	50	4	0	0	45	10	206	2,542
7:30 AM	0	8	1	42	0	0	0	1	0	54	74	4	0	0	20	6	210	2,518
7:35 AM	0	11	1	32	0	0	0	0	0	44	61	9	0	1	45	11	215	2,497
7:40 AM	0	9	0	43	0	4	1	0	0	57	64	1	0	3	49	10	241	2,456
7:45 AM	0	14	1	48	0	1	0	0	0	59	63	4	0	0	35	18	243	2,401
7:50 AM	0	9	0	36	0	1	0	1	0	64	64	5	0	0	52	20	252	2,345
7:55 AM	0	18	1	34	0	0	0	0	0	65	55	9	0	0	24	16	222	2,269
8:00 AM	0	11	1	26	0	2	0	2	0	58	51	3	0	0	35	19	208	2,236
8:05 AM	0	10	0	29	0	0	0	0	0	40	49	4	0	0	35	15	182	
8:10 AM	0	12	0	29	0	1	0	0	0	36	42	4	0	0	37	10	171	
8:15 AM	0	13	0	28	0	3	0	1	0	50	50	3	0	0	33	14	195	
8:20 AM	0	10	0	26	0	0	0	1	0	39	56	1	0	0	54	10	197	
8:25 AM	0	12	1	30	0	0	1	0	0	40	40	7	0	0	43	8	182	
8:30 AM	0	13	0	36	0	0	0	0	0	38	58	3	0	0	29	12	189	
8:35 AM	0	5	0	28	0	0	0	0	0	35	53	1	0	0	43	9	174	
8:40 AM	0	11	0	34	0	0	1	0	0	38	58	3	0	0	32	9	186	
8:45 AM	0	12	0	33	0	3	1	0	0	49	44	2	0	0	31	12	187	
8:50 AM	0	7	1	36	0	2	1	0	0	38	52	1	0	0	29	9	176	
8:55 AM	0	4	0	34	0	2	0	0	0	44	53	3	0	0	37	12	189	
Count Total	0	260	9	811	0	19	6	6	0	1,116	1,294	83	0	4	901	279	4,788	
Peak Hour	0	139	6	419	0	12	1	5	0	633	685	53	0	4	449	163	2,569	

Location: SW Boones Ferry Rd & SW 95th Ave AM

Traffic Counts - Heavy Vehicles, Bicycles on Road, and Pedestrians/Bicycles on Crosswalk

Interval Start Time	Heavy Vehicles					Interval Start Time	Bicycles on Roadway					Interval Start Time	Pedestrians/Bicycles on Crosswalk				
	EB	NB	WB	SB	Total		EB	NB	WB	SB	Total		EB	NB	WB	SB	Total
7:00 AM	9	3	0	9	21	7:00 AM	0	0	0	0	0	7:00 AM	0	0	1	1	2
7:05 AM	10	3	0	10	23	7:05 AM	0	0	0	0	0	7:05 AM	0	0	0	0	0
7:10 AM	7	1	0	9	17	7:10 AM	0	0	0	0	0	7:10 AM	0	0	0	0	0
7:15 AM	13	1	0	6	20	7:15 AM	0	1	0	0	1	7:15 AM	0	0	0	0	0
7:20 AM	10	7	0	5	22	7:20 AM	0	0	0	0	0	7:20 AM	0	0	0	0	0
7:25 AM	9	6	0	8	23	7:25 AM	0	0	0	0	0	7:25 AM	1	0	0	0	1
7:30 AM	5	12	0	7	24	7:30 AM	0	0	0	0	0	7:30 AM	0	0	0	1	1
7:35 AM	8	4	0	8	20	7:35 AM	0	0	0	0	0	7:35 AM	0	0	0	0	0
7:40 AM	14	7	0	9	30	7:40 AM	0	0	0	1	1	7:40 AM	0	0	0	0	0
7:45 AM	10	9	1	6	26	7:45 AM	0	0	0	0	0	7:45 AM	0	0	0	0	0
7:50 AM	6	13	0	4	23	7:50 AM	0	0	0	0	0	7:50 AM	0	0	0	0	0
7:55 AM	7	8	0	6	21	7:55 AM	0	0	0	0	0	7:55 AM	0	0	0	0	0
8:00 AM	7	12	1	5	25	8:00 AM	0	0	0	0	0	8:00 AM	0	0	1	0	1
8:05 AM	6	2	0	4	12	8:05 AM	0	0	0	0	0	8:05 AM	0	0	0	1	1
8:10 AM	5	6	0	3	14	8:10 AM	0	0	0	0	0	8:10 AM	0	0	0	0	0
8:15 AM	6	12	0	4	22	8:15 AM	0	0	0	0	0	8:15 AM	0	0	0	0	0
8:20 AM	3	7	0	5	15	8:20 AM	0	0	0	0	0	8:20 AM	0	0	0	0	0
8:25 AM	10	7	0	5	22	8:25 AM	0	0	0	0	0	8:25 AM	0	0	0	0	0
8:30 AM	6	8	0	3	17	8:30 AM	0	0	0	0	0	8:30 AM	2	0	0	1	3
8:35 AM	9	13	0	6	28	8:35 AM	0	0	0	0	0	8:35 AM	0	0	0	0	0
8:40 AM	6	17	0	3	26	8:40 AM	0	0	0	0	0	8:40 AM	0	0	0	0	0
8:45 AM	4	17	1	3	25	8:45 AM	1	0	0	0	1	8:45 AM	0	0	0	0	0
8:50 AM	6	11	1	1	19	8:50 AM	0	0	0	0	0	8:50 AM	0	0	0	0	0
8:55 AM	6	18	0	9	33	8:55 AM	0	0	0	1	1	8:55 AM	0	0	0	0	0
Count Total	182	204	4	138	528	Count Total	1	1	0	2	4	Count Total	3	0	2	4	9
Peak Hour	93	98	2	69	262	Peak Hour	0	0	0	1	1	Peak Hour	1	0	1	2	4



(303) 216-2439
www.alltrafficdata.net

Location: 9 I-5 NB RAMPS & SW ELLIGSEN RD AM

Date: Tuesday, September 29, 2020

Peak Hour: 07:30 AM - 08:30 AM

Peak 15-Minutes: 07:50 AM - 08:05 AM

Peak Hour

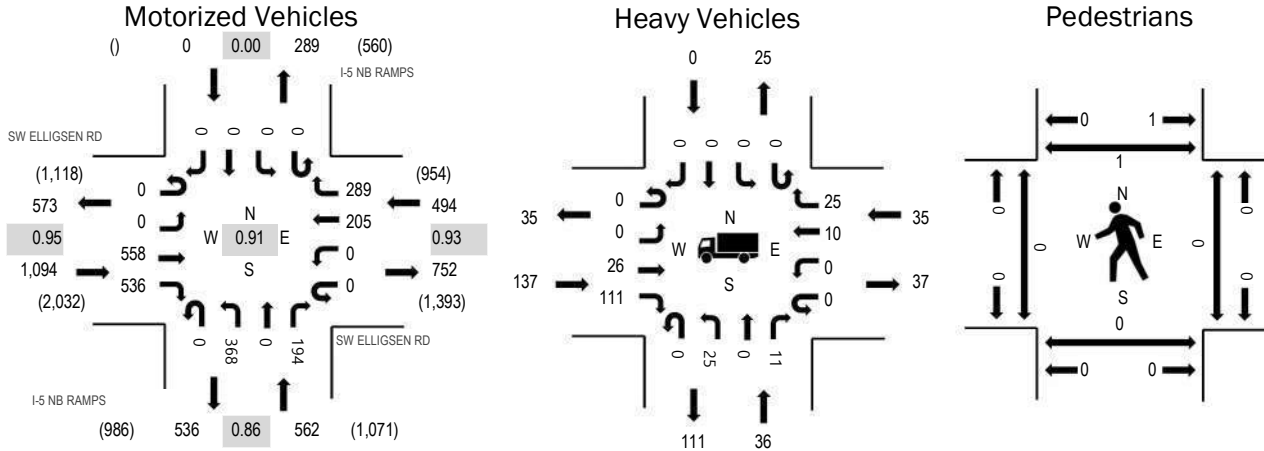

Note: Total study counts contained in parentheses.

	HV%	PHF
EB	12.5%	0.95
WB	7.1%	0.93
NB	6.4%	0.86
SB	0.0%	0.00
All	9.7%	0.91

Traffic Counts - Motorized Vehicles

Interval Start Time	SW ELLIGSEN RD Eastbound				SW ELLIGSEN RD Westbound				I-5 NB RAMPS Northbound				I-5 NB RAMPS Southbound				Total	Rolling Hour
	U-Turn	Left	Thru	Right	U-Turn	Left	Thru	Right	U-Turn	Left	Thru	Right	U-Turn	Left	Thru	Right		
7:00 AM	0	0	33	34	0	0	9	15	0	40	0	4	0	0	0	0	135	2,044
7:05 AM	0	0	34	31	0	0	19	17	0	30	0	9	0	0	0	0	140	2,102
7:10 AM	0	0	29	27	0	0	10	21	0	28	0	12	0	0	0	0	127	2,125
7:15 AM	0	0	32	50	0	0	26	30	0	41	0	9	0	0	0	0	188	2,148
7:20 AM	0	0	42	31	0	0	12	16	0	50	0	10	0	0	0	0	161	2,133
7:25 AM	0	0	38	42	0	0	21	23	0	42	0	12	0	0	0	0	178	2,147
7:30 AM	0	0	41	40	0	0	20	26	0	27	0	12	0	0	0	0	166	2,150
7:35 AM	0	0	40	51	0	0	12	28	0	39	0	11	0	0	0	0	181	2,148
7:40 AM	0	0	50	57	0	0	9	23	0	36	0	10	0	0	0	0	185	2,125
7:45 AM	0	0	40	44	0	0	13	28	0	36	0	24	0	0	0	0	185	2,110
7:50 AM	0	0	48	40	0	0	31	21	0	43	0	16	0	0	0	0	199	2,099
7:55 AM	0	0	60	43	0	0	23	13	0	40	0	20	0	0	0	0	199	2,070
8:00 AM	0	0	52	44	0	0	14	26	0	27	0	30	0	0	0	0	193	2,013
8:05 AM	0	0	47	41	0	0	17	24	0	19	0	15	0	0	0	0	163	
8:10 AM	0	0	48	40	0	0	11	23	0	19	0	9	0	0	0	0	150	
8:15 AM	0	0	50	33	0	0	18	35	0	25	0	12	0	0	0	0	173	
8:20 AM	0	0	34	47	0	0	22	23	0	32	0	17	0	0	0	0	175	
8:25 AM	0	0	48	56	0	0	15	19	0	25	0	18	0	0	0	0	181	
8:30 AM	0	0	42	31	0	0	18	24	0	22	0	27	0	0	0	0	164	
8:35 AM	0	0	55	35	0	0	12	25	0	19	0	12	0	0	0	0	158	
8:40 AM	0	0	43	34	0	0	18	37	0	22	0	16	0	0	0	0	170	
8:45 AM	0	0	55	44	0	0	19	26	0	17	0	13	0	0	0	0	174	
8:50 AM	0	0	46	40	0	0	19	19	0	28	0	18	0	0	0	0	170	
8:55 AM	0	0	39	51	0	0	6	18	0	17	0	11	0	0	0	0	142	
Count Total	0	0	1,046	986	0	0	394	560	0	724	0	347	0	0	0	0	4,057	
Peak Hour	0	0	558	536	0	0	205	289	0	368	0	194	0	0	0	0	2,150	

Traffic Counts - Heavy Vehicles, Bicycles on Road, and Pedestrians/Bicycles on Crosswalk

Interval Start Time	Heavy Vehicles					Interval Start Time	Bicycles on Roadway					Interval Start Time	Pedestrians/Bicycles on Crosswalk				
	EB	NB	WB	SB	Total		EB	NB	WB	SB	Total		EB	NB	WB	SB	Total
7:00 AM	14	0	4	0	18	7:00 AM						7:00 AM	0	0	0	0	0
7:05 AM	11	1	4	0	16	7:05 AM						7:05 AM	0	0	0	0	0
7:10 AM	5	4	4	0	13	7:10 AM						7:10 AM	0	1	0	0	1
7:15 AM	15	7	3	0	25	7:15 AM						7:15 AM	0	1	0	0	1
7:20 AM	9	0	0	0	9	7:20 AM						7:20 AM	0	0	0	0	0
7:25 AM	8	3	2	0	13	7:25 AM						7:25 AM	0	0	0	0	0
7:30 AM	11	1	5	0	17	7:30 AM						7:30 AM	0	0	0	0	0
7:35 AM	17	3	1	0	21	7:35 AM						7:35 AM	0	0	0	0	0
7:40 AM	12	5	1	0	18	7:40 AM						7:40 AM	0	0	0	0	0
7:45 AM	15	5	1	0	21	7:45 AM						7:45 AM	0	0	0	0	0
7:50 AM	10	3	4	0	17	7:50 AM						7:50 AM	0	0	0	1	1
7:55 AM	14	2	4	0	20	7:55 AM						7:55 AM	0	0	0	0	0
8:00 AM	11	4	4	0	19	8:00 AM						8:00 AM	0	0	0	0	0
8:05 AM	9	1	1	0	11	8:05 AM						8:05 AM	0	0	0	0	0
8:10 AM	11	5	2	0	18	8:10 AM						8:10 AM	0	0	0	0	0
8:15 AM	10	3	8	0	21	8:15 AM						8:15 AM	0	0	0	0	0
8:20 AM	8	3	2	0	13	8:20 AM						8:20 AM	0	0	0	0	0
8:25 AM	9	1	2	0	12	8:25 AM						8:25 AM	0	0	0	0	0
8:30 AM	7	2	1	0	10	8:30 AM						8:30 AM	0	0	0	0	0
8:35 AM	13	4	2	0	19	8:35 AM						8:35 AM	0	0	0	0	0
8:40 AM	5	2	1	0	8	8:40 AM						8:40 AM	0	0	0	0	0
8:45 AM	16	4	4	0	24	8:45 AM						8:45 AM	0	0	0	0	0
8:50 AM	9	2	1	0	12	8:50 AM						8:50 AM	0	0	0	0	0
8:55 AM	11	1	1	0	13	8:55 AM						8:55 AM	0	0	0	0	0
Count Total	260	66	62	0	388	Count Total						Count Total	0	2	0	1	3
Peak Hour	137	36	35	0	208	Peak Hour						Peak Hour	0	0	0	1	1



(303) 216-2439
www.alltrafficdata.net

Location: 8 I-5 SB RAMPS & SW BOONES FERRY RD AM

Date: Tuesday, September 29, 2020

Peak Hour: 07:10 AM - 08:10 AM

Peak 15-Minutes: 07:40 AM - 07:55 AM

Peak Hour

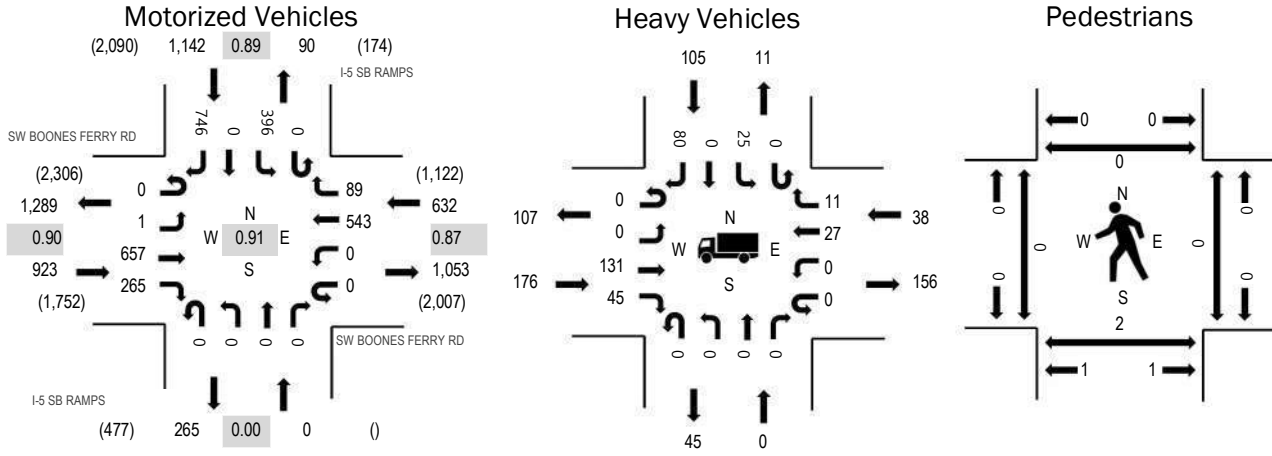

Note: Total study counts contained in parentheses.

	HV%	PHF
EB	19.1%	0.90
WB	6.0%	0.87
NB	0.0%	0.00
SB	9.2%	0.89
All	11.8%	0.91

Traffic Counts - Motorized Vehicles

Interval Start Time	SW BOONES FERRY RD Eastbound				SW BOONES FERRY RD Westbound				I-5 SB RAMPS Northbound				I-5 SB RAMPS Southbound				Total	Rolling Hour
	U-Turn	Left	Thru	Right	U-Turn	Left	Thru	Right	U-Turn	Left	Thru	Right	U-Turn	Left	Thru	Right		
7:00 AM	0	0	39	19	0	0	52	7	0	0	0	0	0	15	0	56	188	2,634
7:05 AM	0	0	41	27	0	0	42	5	0	0	0	0	0	15	0	49	179	2,676
7:10 AM	0	0	44	16	0	0	37	7	0	0	0	0	0	34	0	57	195	2,697
7:15 AM	0	0	57	23	0	0	56	7	0	0	0	0	0	22	0	37	202	2,691
7:20 AM	0	0	43	20	0	0	62	8	0	0	0	0	0	33	0	68	234	2,679
7:25 AM	0	0	51	26	0	0	48	5	0	0	0	0	0	18	0	51	199	2,639
7:30 AM	0	0	61	20	0	0	43	5	0	0	0	0	0	35	0	66	230	2,624
7:35 AM	0	1	59	29	0	0	38	6	0	0	0	0	0	26	0	68	227	2,589
7:40 AM	0	0	69	25	0	0	41	12	0	0	0	0	0	39	0	74	260	2,548
7:45 AM	0	0	49	30	0	0	56	9	0	0	0	0	0	31	0	63	238	2,460
7:50 AM	0	0	60	17	0	0	48	9	0	0	0	0	0	39	0	74	247	2,426
7:55 AM	0	0	59	19	0	0	38	8	0	0	0	0	0	45	0	66	235	2,373
8:00 AM	0	0	64	25	0	0	34	6	0	0	0	0	0	33	0	68	230	2,330
8:05 AM	0	0	41	15	0	0	42	7	0	0	0	0	0	41	0	54	200	
8:10 AM	0	0	54	16	0	0	26	4	0	0	0	0	0	34	0	55	189	
8:15 AM	0	0	46	34	0	0	27	11	0	0	0	0	0	26	0	46	190	
8:20 AM	0	0	67	11	0	0	39	3	0	0	0	0	0	14	0	60	194	
8:25 AM	0	0	46	15	0	0	32	10	0	0	0	0	0	32	0	49	184	
8:30 AM	0	0	50	12	0	0	29	10	0	0	0	0	0	37	0	57	195	
8:35 AM	0	0	53	17	0	0	32	4	0	0	0	0	0	25	0	55	186	
8:40 AM	0	0	42	11	0	0	37	8	0	0	0	0	0	25	0	49	172	
8:45 AM	0	0	53	21	0	0	31	9	0	0	0	0	0	42	1	47	204	
8:50 AM	0	0	57	11	0	0	31	7	0	0	0	0	0	43	0	45	194	
8:55 AM	0	0	70	17	0	0	28	6	0	0	0	0	0	28	0	43	192	
Count Total	0	1	1,275	476	0	0	949	173	0	0	0	0	0	732	1	1,357	4,964	
Peak Hour	0	1	657	265	0	0	543	89	0	0	0	0	0	396	0	746	2,697	

Traffic Counts - Heavy Vehicles, Bicycles on Road, and Pedestrians/Bicycles on Crosswalk

Interval Start Time	Heavy Vehicles					Interval Start Time	Bicycles on Roadway					Interval Start Time	Pedestrians/Bicycles on Crosswalk				
	EB	NB	WB	SB	Total		EB	NB	WB	SB	Total		EB	NB	WB	SB	Total
7:00 AM	18	0	1	7	26	7:00 AM						7:00 AM	0	1	0	0	1
7:05 AM	11	0	3	6	20	7:05 AM						7:05 AM	0	0	0	0	0
7:10 AM	11	0	0	5	16	7:10 AM						7:10 AM	0	1	0	0	1
7:15 AM	12	0	9	4	25	7:15 AM						7:15 AM	0	1	0	0	1
7:20 AM	15	0	3	9	27	7:20 AM						7:20 AM	0	0	0	0	0
7:25 AM	12	0	1	7	20	7:25 AM						7:25 AM	0	0	0	0	0
7:30 AM	16	0	4	10	30	7:30 AM						7:30 AM	0	0	0	0	0
7:35 AM	15	0	3	15	33	7:35 AM						7:35 AM	0	0	0	0	0
7:40 AM	12	0	4	8	24	7:40 AM						7:40 AM	0	0	0	0	0
7:45 AM	11	0	4	7	22	7:45 AM						7:45 AM	0	0	0	0	0
7:50 AM	16	0	4	11	31	7:50 AM						7:50 AM	0	0	0	0	0
7:55 AM	19	0	2	4	25	7:55 AM						7:55 AM	0	0	0	0	0
8:00 AM	20	0	2	14	36	8:00 AM						8:00 AM	0	0	0	0	0
8:05 AM	17	0	2	11	30	8:05 AM						8:05 AM	0	0	0	0	0
8:10 AM	9	0	2	8	19	8:10 AM						8:10 AM	0	0	0	0	0
8:15 AM	15	0	3	6	24	8:15 AM						8:15 AM	0	0	0	0	0
8:20 AM	7	0	2	6	15	8:20 AM						8:20 AM	0	0	0	0	0
8:25 AM	9	0	1	13	23	8:25 AM						8:25 AM	0	2	0	0	2
8:30 AM	6	0	5	12	23	8:30 AM						8:30 AM	0	0	0	0	0
8:35 AM	10	0	2	11	23	8:35 AM						8:35 AM	0	0	0	0	0
8:40 AM	5	0	6	9	20	8:40 AM						8:40 AM	0	0	0	0	0
8:45 AM	15	0	2	7	24	8:45 AM						8:45 AM	0	0	0	0	0
8:50 AM	9	0	1	6	16	8:50 AM						8:50 AM	0	0	0	0	0
8:55 AM	15	0	1	9	25	8:55 AM						8:55 AM	0	0	0	0	0
Count Total	305	0	67	205	577	Count Total						Count Total	0	5	0	0	5
Peak Hour	176	0	38	105	319	Peak Hour						Peak Hour	0	2	0	0	2



(303) 216-2439

www.alltrafficdata.net

Location: 4 SW 89TH AVE & SW NORWOOD RD AM

Date: Tuesday, September 29, 2020

Peak Hour: 07:10 AM - 08:10 AM

Peak 15-Minutes: 08:00 AM - 08:15 AM

Peak Hour

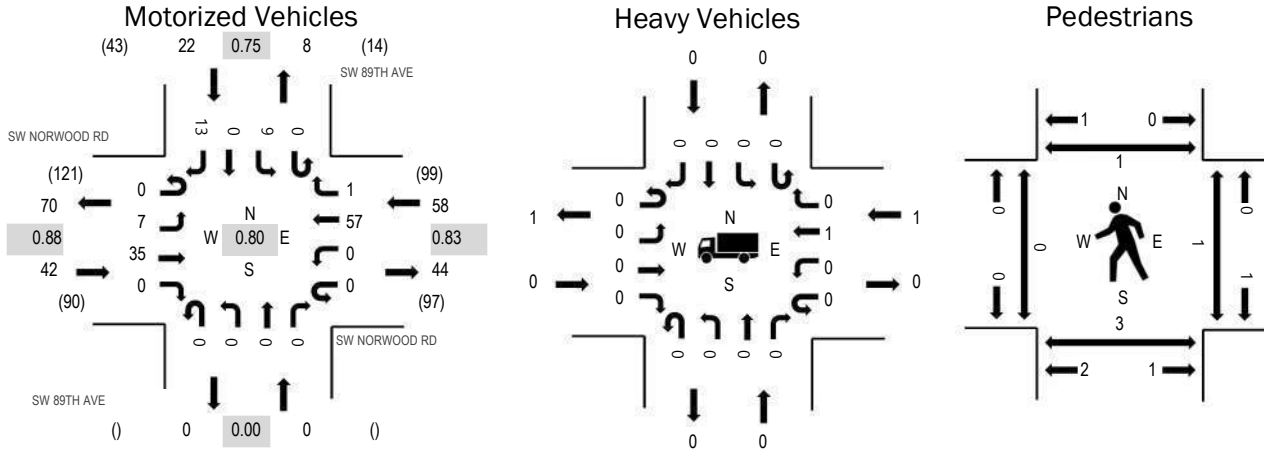

Note: Total study counts contained in parentheses.

	HV%	PHF
EB	0.0%	0.88
WB	1.7%	0.83
NB	0.0%	0.00
SB	0.0%	0.75
All	0.8%	0.80

Traffic Counts - Motorized Vehicles

Interval Start Time	SW NORWOOD RD Eastbound				SW NORWOOD RD Westbound				SW 89TH AVE Northbound				SW 89TH AVE Southbound				Total	Rolling Hour
	U-Turn	Left	Thru	Right	U-Turn	Left	Thru	Right	U-Turn	Left	Thru	Right	U-Turn	Left	Thru	Right		
7:00 AM	0	0	3	0	0	0	1	0	0	0	0	0	0	1	0	1	6	113
7:05 AM	0	0	4	0	0	0	3	0	0	0	0	0	0	0	0	1	8	116
7:10 AM	0	0	7	0	0	0	5	0	0	0	0	0	0	0	0	4	16	122
7:15 AM	0	0	2	0	0	0	4	0	0	0	0	0	0	0	0	1	7	121
7:20 AM	0	1	1	0	0	0	7	0	0	0	0	0	0	0	0	0	9	121
7:25 AM	0	1	1	0	0	0	5	1	0	0	0	0	0	1	0	0	9	120
7:30 AM	0	0	2	0	0	0	5	0	0	0	0	0	0	2	0	0	9	119
7:35 AM	0	1	4	0	0	0	5	0	0	0	0	0	0	2	0	0	12	121
7:40 AM	0	2	2	0	0	0	6	0	0	0	0	0	0	0	0	1	11	116
7:45 AM	0	0	4	0	0	0	4	0	0	0	0	0	0	2	0	3	13	114
7:50 AM	0	1	3	0	0	0	2	0	0	0	0	0	0	0	0	0	6	112
7:55 AM	0	0	2	0	0	0	5	0	0	0	0	0	0	0	0	0	7	115
8:00 AM	0	0	4	0	0	0	4	0	0	0	0	0	0	0	0	1	9	119
8:05 AM	0	1	3	0	0	0	5	0	0	0	0	0	0	2	0	3	14	
8:10 AM	0	0	6	0	0	0	7	0	0	0	0	0	0	1	0	1	15	
8:15 AM	0	1	3	0	0	0	2	0	0	0	0	0	0	0	0	1	7	
8:20 AM	0	1	3	0	0	0	3	0	0	0	0	0	0	0	0	1	8	
8:25 AM	0	0	2	0	0	0	5	0	0	0	0	0	0	0	0	1	8	
8:30 AM	0	1	4	0	0	0	4	0	0	0	0	0	0	1	0	1	11	
8:35 AM	0	0	3	0	0	0	2	0	0	0	0	0	0	2	0	0	7	
8:40 AM	0	0	4	0	0	0	4	0	0	0	0	0	0	0	0	1	9	
8:45 AM	0	1	3	0	0	0	4	0	0	0	0	0	0	1	0	2	11	
8:50 AM	0	0	4	0	0	0	2	1	0	0	0	0	0	2	0	0	9	
8:55 AM	0	0	5	0	0	0	2	1	0	0	0	0	0	1	0	2	11	
Count Total	0	11	79	0	0	0	96	3	0	0	0	0	0	18	0	25	232	
Peak Hour	0	7	35	0	0	0	57	1	0	0	0	0	0	9	0	13	122	

Traffic Counts - Heavy Vehicles, Bicycles on Road, and Pedestrians/Bicycles on Crosswalk

Interval Start Time	Heavy Vehicles					Interval Start Time	Bicycles on Roadway					Interval Start Time	Pedestrians/Bicycles on Crosswalk				
	EB	NB	WB	SB	Total		EB	NB	WB	SB	Total		EB	NB	WB	SB	Total
7:00 AM	0	0	0	0	0	7:00 AM						7:00 AM	0	0	0	0	0
7:05 AM	0	0	0	0	0	7:05 AM						7:05 AM	0	0	0	0	0
7:10 AM	0	0	0	0	0	7:10 AM						7:10 AM	0	0	0	0	0
7:15 AM	0	0	1	0	1	7:15 AM						7:15 AM	0	0	0	0	0
7:20 AM	0	0	0	0	0	7:20 AM						7:20 AM	0	0	0	0	0
7:25 AM	0	0	0	0	0	7:25 AM						7:25 AM	0	0	0	0	0
7:30 AM	0	0	0	0	0	7:30 AM						7:30 AM	0	0	0	0	0
7:35 AM	0	0	0	0	0	7:35 AM						7:35 AM	0	0	0	0	0
7:40 AM	0	0	0	0	0	7:40 AM						7:40 AM	0	0	0	0	0
7:45 AM	0	0	0	0	0	7:45 AM						7:45 AM	0	0	0	0	0
7:50 AM	0	0	0	0	0	7:50 AM						7:50 AM	0	1	0	0	1
7:55 AM	0	0	0	0	0	7:55 AM						7:55 AM	0	0	0	0	0
8:00 AM	0	0	0	0	0	8:00 AM						8:00 AM	0	2	1	0	3
8:05 AM	0	0	0	0	0	8:05 AM						8:05 AM	0	0	0	1	1
8:10 AM	0	0	0	0	0	8:10 AM						8:10 AM	0	0	0	0	0
8:15 AM	0	0	0	0	0	8:15 AM						8:15 AM	0	0	0	0	0
8:20 AM	0	0	0	0	0	8:20 AM						8:20 AM	0	0	0	1	1
8:25 AM	0	0	0	0	0	8:25 AM						8:25 AM	0	0	0	0	0
8:30 AM	0	0	1	0	1	8:30 AM						8:30 AM	0	0	0	1	1
8:35 AM	0	0	0	0	0	8:35 AM						8:35 AM	0	0	0	0	0
8:40 AM	0	0	0	0	0	8:40 AM						8:40 AM	0	1	0	0	1
8:45 AM	0	0	0	0	0	8:45 AM						8:45 AM	0	1	0	0	1
8:50 AM	0	0	0	0	0	8:50 AM						8:50 AM	0	0	0	0	0
8:55 AM	0	0	0	0	0	8:55 AM						8:55 AM	0	0	0	0	0
Count Total	0	0	2	0	2	Count Total						Count Total	0	5	1	3	9
Peak Hour	0	0	1	0	1	Peak Hour						Peak Hour	0	3	1	1	5



(303) 216-2439
www.alltrafficdata.net

Location: 5 SW VERMILLION DR & SW NORWOOD RD AM

Date: Tuesday, September 29, 2020

Peak Hour: 07:15 AM - 08:15 AM

Peak 15-Minutes: 07:35 AM - 07:50 AM

Peak Hour

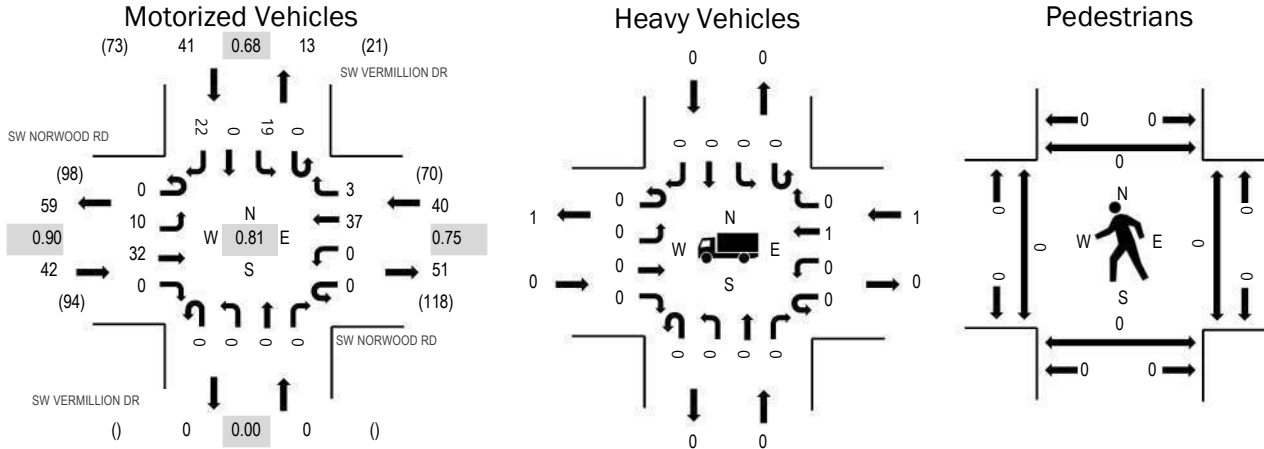

Note: Total study counts contained in parentheses.

	HV%	PHF
EB	0.0%	0.90
WB	2.5%	0.75
NB	0.0%	0.00
SB	0.0%	0.68
All	0.8%	0.81

Traffic Counts - Motorized Vehicles

Interval Start Time	SW NORWOOD RD Eastbound				SW NORWOOD RD Westbound				SW VERMILLION DR Northbound				SW VERMILLION DR Southbound				Total	Rolling Hour
	U-Turn	Left	Thru	Right	U-Turn	Left	Thru	Right	U-Turn	Left	Thru	Right	U-Turn	Left	Thru	Right		
7:00 AM	0	0	2	0	0	0	0	0	0	0	0	0	0	2	0	1	5	115
7:05 AM	0	0	6	0	0	0	1	1	0	0	0	0	0	1	0	1	10	121
7:10 AM	0	0	5	0	0	0	1	0	0	0	0	0	0	2	0	3	11	120
7:15 AM	0	0	4	0	0	0	4	0	0	0	0	0	0	0	0	0	8	123
7:20 AM	0	0	1	0	0	0	4	0	0	0	0	0	0	1	0	2	8	123
7:25 AM	0	0	2	0	0	0	0	1	0	0	0	0	0	2	0	5	10	122
7:30 AM	0	0	2	0	0	0	3	0	0	0	0	0	0	1	0	4	10	122
7:35 AM	0	1	6	0	0	0	2	0	0	0	0	0	0	1	0	3	13	119
7:40 AM	0	0	1	0	0	0	4	1	0	0	0	0	0	4	0	4	14	121
7:45 AM	0	3	2	0	0	0	2	0	0	0	0	0	0	2	0	2	11	117
7:50 AM	0	1	3	0	0	0	2	0	0	0	0	0	0	2	0	0	8	115
7:55 AM	0	0	1	0	0	0	3	0	0	0	0	0	0	2	0	1	7	118
8:00 AM	0	1	3	0	0	0	5	0	0	0	0	0	0	2	0	0	11	122
8:05 AM	0	2	2	0	0	0	2	1	0	0	0	0	0	1	0	1	9	
8:10 AM	0	2	5	0	0	0	6	0	0	0	0	0	0	1	0	0	14	
8:15 AM	0	0	4	0	0	0	4	0	0	0	0	0	0	0	0	0	8	
8:20 AM	0	1	2	0	0	0	2	0	0	0	0	0	0	1	0	1	7	
8:25 AM	0	0	3	0	0	0	5	0	0	0	0	0	0	1	0	1	10	
8:30 AM	0	0	3	0	0	0	1	0	0	0	0	0	0	1	0	2	7	
8:35 AM	0	1	5	0	0	0	4	0	0	0	0	0	0	5	0	0	15	
8:40 AM	0	2	3	0	0	0	3	0	0	0	0	0	0	2	0	0	10	
8:45 AM	0	1	2	0	0	0	2	0	0	0	0	0	0	3	0	1	9	
8:50 AM	0	0	6	0	0	0	2	0	0	0	0	0	0	3	0	0	11	
8:55 AM	0	1	5	0	0	0	3	1	0	0	0	0	0	0	0	1	11	
Count Total	0	16	78	0	0	0	65	5	0	0	0	0	0	40	0	33	237	
Peak Hour	0	10	32	0	0	0	37	3	0	0	0	0	0	19	0	22	123	

Traffic Counts - Heavy Vehicles, Bicycles on Road, and Pedestrians/Bicycles on Crosswalk

Interval Start Time	Heavy Vehicles					Interval Start Time	Bicycles on Roadway					Interval Start Time	Pedestrians/Bicycles on Crosswalk				
	EB	NB	WB	SB	Total		EB	NB	WB	SB	Total		EB	NB	WB	SB	Total
7:00 AM	0	0	0	0	0	7:00 AM						7:00 AM	0	0	0	0	0
7:05 AM	0	0	0	0	0	7:05 AM						7:05 AM	0	0	0	0	0
7:10 AM	0	0	0	0	0	7:10 AM						7:10 AM	0	0	0	0	0
7:15 AM	0	0	0	0	0	7:15 AM						7:15 AM	0	0	0	0	0
7:20 AM	0	0	1	0	1	7:20 AM						7:20 AM	0	0	0	0	0
7:25 AM	0	0	0	0	0	7:25 AM						7:25 AM	0	0	0	0	0
7:30 AM	0	0	0	0	0	7:30 AM						7:30 AM	0	0	0	0	0
7:35 AM	0	0	0	0	0	7:35 AM						7:35 AM	0	0	0	0	0
7:40 AM	0	0	0	0	0	7:40 AM						7:40 AM	0	0	0	0	0
7:45 AM	0	0	0	0	0	7:45 AM						7:45 AM	0	0	0	0	0
7:50 AM	0	0	0	0	0	7:50 AM						7:50 AM	0	0	0	0	0
7:55 AM	0	0	0	0	0	7:55 AM						7:55 AM	0	0	0	0	0
8:00 AM	0	0	0	0	0	8:00 AM						8:00 AM	0	0	0	0	0
8:05 AM	0	0	0	0	0	8:05 AM						8:05 AM	0	0	0	0	0
8:10 AM	0	0	0	0	0	8:10 AM						8:10 AM	0	0	0	0	0
8:15 AM	0	0	0	0	0	8:15 AM						8:15 AM	0	0	0	0	0
8:20 AM	0	0	0	0	0	8:20 AM						8:20 AM	0	0	0	0	0
8:25 AM	0	0	0	0	0	8:25 AM						8:25 AM	0	0	0	0	0
8:30 AM	0	0	0	0	0	8:30 AM						8:30 AM	0	0	0	0	0
8:35 AM	0	0	1	0	1	8:35 AM						8:35 AM	0	0	0	0	0
8:40 AM	0	0	0	0	0	8:40 AM						8:40 AM	0	1	0	0	1
8:45 AM	0	0	0	0	0	8:45 AM						8:45 AM	0	0	0	1	1
8:50 AM	0	0	0	0	0	8:50 AM						8:50 AM	0	0	0	0	0
8:55 AM	0	0	0	0	0	8:55 AM						8:55 AM	0	0	0	0	0
Count Total	0	0	2	0	2	Count Total						Count Total	0	1	0	1	2
Peak Hour	0	0	1	0	1	Peak Hour						Peak Hour	0	0	0	0	0



ALL TRAFFIC DATA SERVICES

(303) 216-2439

www.alltrafficdata.net

Location: 6 SW 82ND AVE & SW NORWOOD RD AM

Date: Wednesday, October 7, 2020

Peak Hour: 07:00 AM - 08:00 AM

Peak 15-Minutes: 07:35 AM - 07:50 AM

Peak Hour

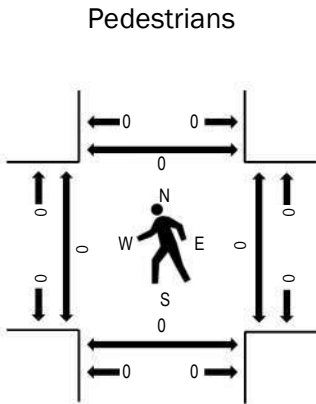
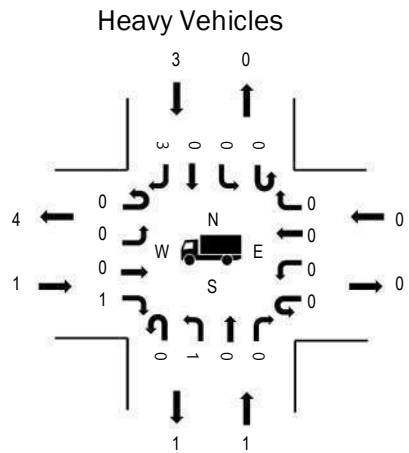
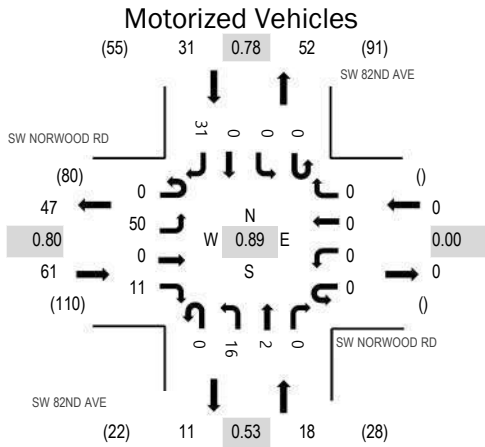

Note: Total study counts contained in parentheses.

	HV%	PHF
EB	1.6%	0.80
WB	0.0%	0.00
NB	5.6%	0.53
SB	9.7%	0.78
All	4.5%	0.89

Traffic Counts - Motorized Vehicles

Interval Start Time	SW NORWOOD RD Eastbound				SW NORWOOD RD Westbound				SW 82ND AVE Northbound				SW 82ND AVE Southbound				Total	Rolling Hour
	U-Turn	Left	Thru	Right	U-Turn	Left	Thru	Right	U-Turn	Left	Thru	Right	U-Turn	Left	Thru	Right		
7:00 AM	0	4	0	1	0	0	0	0	0	1	0	0	0	0	0	2	8	110
7:05 AM	0	4	0	1	0	0	0	0	0	2	0	0	0	0	0	1	8	108
7:10 AM	0	4	0	1	0	0	0	0	0	0	0	0	0	0	4	9	105	
7:15 AM	0	6	0	2	0	0	0	0	0	1	1	0	0	0	3	13	99	
7:20 AM	0	1	0	3	0	0	0	0	0	0	0	0	0	0	3	7	95	
7:25 AM	0	3	0	0	0	0	0	0	0	2	0	0	0	0	2	7	95	
7:30 AM	0	3	0	0	0	0	0	0	0	3	0	0	0	0	2	8	96	
7:35 AM	0	3	0	2	0	0	0	0	0	2	0	0	0	0	3	10	88	
7:40 AM	0	4	0	0	0	0	0	0	0	3	1	0	0	0	4	12	87	
7:45 AM	0	6	0	0	0	0	0	0	0	0	0	0	0	0	3	9	80	
7:50 AM	0	7	0	1	0	0	0	0	0	0	0	0	0	0	2	10	77	
7:55 AM	0	5	0	0	0	0	0	0	0	2	0	0	0	0	2	9	78	
8:00 AM	0	5	0	0	0	0	0	0	0	0	0	0	0	0	1	6	83	
8:05 AM	0	3	0	0	0	0	0	0	0	0	0	0	0	0	2	5		
8:10 AM	0	2	0	1	0	0	0	0	0	0	0	0	0	0	0	3		
8:15 AM	0	5	0	0	0	0	0	0	0	2	0	0	0	0	2	9		
8:20 AM	0	2	0	1	0	0	0	0	0	1	1	0	0	0	2	7		
8:25 AM	0	1	0	2	0	0	0	0	0	4	0	0	0	0	1	8		
8:30 AM	0	0	0	0	0	0	0	0	0	0	0	0	0	0	0	0		
8:35 AM	0	4	0	1	0	0	0	0	0	0	0	0	0	0	4	9		
8:40 AM	0	1	0	0	0	0	0	0	0	0	0	0	0	0	4	5		
8:45 AM	0	3	0	2	0	0	0	0	0	0	0	0	0	0	1	6		
8:50 AM	0	6	0	2	0	0	0	0	0	0	0	0	0	0	3	11		
8:55 AM	0	6	0	2	0	0	0	0	0	2	0	0	0	0	4	14		
Count Total	0	88	0	22	0	0	0	0	0	25	3	0	0	0	55	193		
Peak Hour	0	50	0	11	0	0	0	0	0	16	2	0	0	0	31	110		

Traffic Counts - Heavy Vehicles, Bicycles on Road, and Pedestrians/Bicycles on Crosswalk

Interval Start Time	Heavy Vehicles					Interval Start Time	Bicycles on Roadway					Interval Start Time	Pedestrians/Bicycles on Crosswalk				
	EB	NB	WB	SB	Total		EB	NB	WB	SB	Total		EB	NB	WB	SB	Total
7:00 AM	0	0	0	0	0	7:00 AM						7:00 AM	0	0	0	0	0
7:05 AM	0	0	0	0	0	7:05 AM						7:05 AM	0	0	0	0	0
7:10 AM	0	0	0	0	0	7:10 AM						7:10 AM	0	0	0	0	0
7:15 AM	0	0	0	0	0	7:15 AM						7:15 AM	0	0	0	0	0
7:20 AM	0	0	0	1	1	7:20 AM						7:20 AM	0	0	0	0	0
7:25 AM	0	0	0	1	1	7:25 AM						7:25 AM	0	0	0	0	0
7:30 AM	0	0	0	0	0	7:30 AM						7:30 AM	0	0	0	0	0
7:35 AM	1	0	0	1	2	7:35 AM						7:35 AM	0	0	0	0	0
7:40 AM	0	1	0	0	1	7:40 AM						7:40 AM	0	0	0	0	0
7:45 AM	0	0	0	0	0	7:45 AM						7:45 AM	0	0	0	0	0
7:50 AM	0	0	0	0	0	7:50 AM						7:50 AM	0	0	0	0	0
7:55 AM	0	0	0	0	0	7:55 AM						7:55 AM	0	0	0	0	0
8:00 AM	0	0	0	0	0	8:00 AM						8:00 AM	0	0	0	0	0
8:05 AM	0	0	0	0	0	8:05 AM						8:05 AM	0	0	0	0	0
8:10 AM	0	0	0	0	0	8:10 AM						8:10 AM	0	0	0	0	0
8:15 AM	0	1	0	0	1	8:15 AM						8:15 AM	0	0	0	0	0
8:20 AM	0	0	0	0	0	8:20 AM						8:20 AM	0	0	0	0	0
8:25 AM	0	0	0	0	0	8:25 AM						8:25 AM	0	0	0	0	0
8:30 AM	0	0	0	0	0	8:30 AM						8:30 AM	0	0	0	0	0
8:35 AM	0	0	0	0	0	8:35 AM						8:35 AM	0	0	0	0	0
8:40 AM	0	0	0	0	0	8:40 AM						8:40 AM	0	0	0	0	0
8:45 AM	0	0	0	0	0	8:45 AM						8:45 AM	0	0	0	0	0
8:50 AM	0	0	0	0	0	8:50 AM						8:50 AM	0	0	0	0	0
8:55 AM	0	1	0	0	1	8:55 AM						8:55 AM	0	0	0	0	0
Count Total	1	3	0	3	7	Count Total						Count Total	0	0	0	0	0
Peak Hour	1	1	0	3	5	Peak Hour						Peak Hour	0	0	0	0	0



(303) 216-2439
www.alltrafficdata.net

Location: 7 SW 65TH AVE & SW NORWOOD RD AM

Date: Tuesday, September 29, 2020

Peak Hour: 07:35 AM - 08:35 AM

Peak 15-Minutes: 08:05 AM - 08:20 AM

Peak Hour

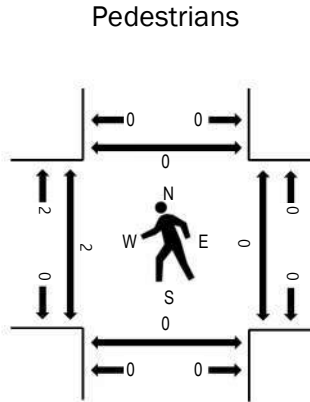
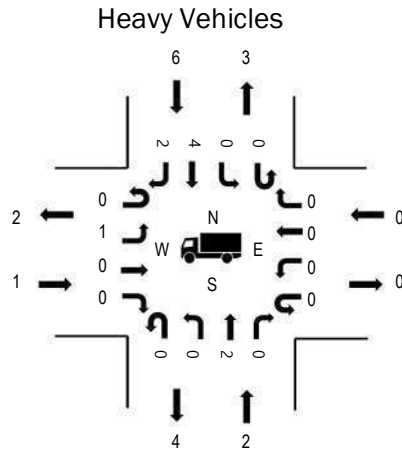
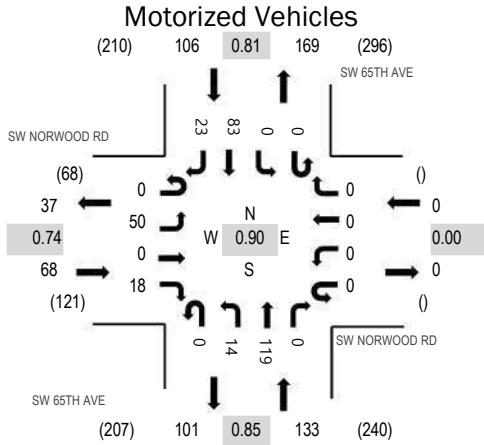

Note: Total study counts contained in parentheses.

	HV%	PHF
EB	1.5%	0.74
WB	0.0%	0.00
NB	1.5%	0.85
SB	5.7%	0.81
All	2.9%	0.90

Traffic Counts - Motorized Vehicles

Interval Start Time	SW NORWOOD RD Eastbound				SW NORWOOD RD Westbound				SW 65TH AVE Northbound				SW 65TH AVE Southbound				Total	Rolling Hour
	U-Turn	Left	Thru	Right	U-Turn	Left	Thru	Right	U-Turn	Left	Thru	Right	U-Turn	Left	Thru	Right		
7:00 AM	0	1	0	3	0	0	0	0	0	1	14	0	0	0	9	1	29	280
7:05 AM	0	3	0	0	0	0	0	0	0	4	11	0	0	0	5	3	26	276
7:10 AM	0	3	0	0	0	0	0	0	0	1	11	0	0	0	11	0	26	279
7:15 AM	0	6	0	6	0	0	0	0	0	0	5	0	0	0	7	1	25	278
7:20 AM	0	3	0	4	0	0	0	0	0	1	7	0	0	0	6	1	22	284
7:25 AM	0	1	0	2	0	0	0	0	0	2	5	0	0	0	4	1	15	283
7:30 AM	0	1	0	1	0	0	0	0	0	0	4	0	0	0	2	1	9	296
7:35 AM	0	5	0	1	0	0	0	0	0	1	10	0	0	0	10	1	28	307
7:40 AM	0	4	0	4	0	0	0	0	0	1	18	0	0	0	3	0	30	296
7:45 AM	0	2	0	3	0	0	0	0	0	0	4	0	0	0	5	3	17	284
7:50 AM	0	6	0	1	0	0	0	0	0	0	12	0	0	0	7	2	28	291
7:55 AM	0	3	0	1	0	0	0	0	0	3	11	0	0	0	6	1	25	289
8:00 AM	0	4	0	0	0	0	0	0	0	1	8	0	0	0	9	3	25	291
8:05 AM	0	8	0	3	0	0	0	0	0	2	5	0	0	0	11	0	29	
8:10 AM	0	5	0	0	0	0	0	0	0	3	6	0	0	0	9	2	25	
8:15 AM	0	7	0	2	0	0	0	0	0	1	14	0	0	0	5	2	31	
8:20 AM	0	1	0	1	0	0	0	0	0	1	8	0	0	0	8	2	21	
8:25 AM	0	0	0	1	0	0	0	0	0	1	14	0	0	0	6	6	28	
8:30 AM	0	5	0	1	0	0	0	0	0	0	9	0	0	0	4	1	20	
8:35 AM	0	4	0	0	0	0	0	0	0	0	1	0	0	0	7	5	17	
8:40 AM	0	5	0	1	0	0	0	0	0	1	8	0	0	0	3	0	18	
8:45 AM	0	2	0	3	0	0	0	0	0	1	7	0	0	0	7	4	24	
8:50 AM	0	2	0	1	0	0	0	0	0	1	9	0	0	0	12	1	26	
8:55 AM	0	1	0	0	0	0	0	0	0	0	13	0	0	0	12	1	27	
Count Total	0	82	0	39	0	0	0	0	0	26	214	0	0	0	168	42	571	
Peak Hour	0	50	0	18	0	0	0	0	0	14	119	0	0	0	83	23	307	

Traffic Counts - Heavy Vehicles, Bicycles on Road, and Pedestrians/Bicycles on Crosswalk

Interval Start Time	Heavy Vehicles					Interval Start Time	Bicycles on Roadway					Interval Start Time	Pedestrians/Bicycles on Crosswalk				
	EB	NB	WB	SB	Total		EB	NB	WB	SB	Total		EB	NB	WB	SB	Total
7:00 AM	0	1	0	0	1	7:00 AM						7:00 AM	0	0	0	0	0
7:05 AM	0	0	0	0	0	7:05 AM						7:05 AM	0	0	0	0	0
7:10 AM	0	0	0	0	0	7:10 AM						7:10 AM	0	0	0	0	0
7:15 AM	1	0	0	0	1	7:15 AM						7:15 AM	0	0	0	0	0
7:20 AM	0	0	0	0	0	7:20 AM						7:20 AM	0	0	0	0	0
7:25 AM	0	0	0	1	1	7:25 AM						7:25 AM	0	0	0	0	0
7:30 AM	0	0	0	1	1	7:30 AM						7:30 AM	0	0	0	0	0
7:35 AM	0	0	0	0	0	7:35 AM						7:35 AM	0	0	0	0	0
7:40 AM	0	0	0	0	0	7:40 AM						7:40 AM	0	0	0	0	0
7:45 AM	0	0	0	0	0	7:45 AM						7:45 AM	0	0	0	0	0
7:50 AM	0	0	0	0	0	7:50 AM						7:50 AM	2	0	0	0	2
7:55 AM	0	0	0	2	2	7:55 AM						7:55 AM	0	0	0	0	0
8:00 AM	0	0	0	0	0	8:00 AM						8:00 AM	0	0	0	0	0
8:05 AM	0	0	0	0	0	8:05 AM						8:05 AM	0	0	0	0	0
8:10 AM	0	0	0	1	1	8:10 AM						8:10 AM	0	0	0	0	0
8:15 AM	0	2	0	0	2	8:15 AM						8:15 AM	0	0	0	0	0
8:20 AM	0	0	0	1	1	8:20 AM						8:20 AM	0	0	0	0	0
8:25 AM	0	0	0	1	1	8:25 AM						8:25 AM	0	0	0	0	0
8:30 AM	1	0	0	1	2	8:30 AM						8:30 AM	0	0	0	0	0
8:35 AM	0	0	0	0	0	8:35 AM						8:35 AM	0	0	0	0	0
8:40 AM	1	0	0	0	1	8:40 AM						8:40 AM	0	0	0	0	0
8:45 AM	0	0	0	1	1	8:45 AM						8:45 AM	0	0	0	0	0
8:50 AM	0	0	0	1	1	8:50 AM						8:50 AM	0	0	0	0	0
8:55 AM	0	1	0	2	3	8:55 AM						8:55 AM	0	0	0	0	0
Count Total	3	4	0	12	19	Count Total						Count Total	2	0	0	0	2
Peak Hour	1	2	0	6	9	Peak Hour						Peak Hour	2	0	0	0	2



(303) 216-2439
www.alltrafficdata.net

Location: 1 SW Boones Ferry Rd & SW Sagert St PM

Date: Thursday, May 6, 2021

Peak Hour: 04:00 PM - 05:00 PM

Peak 15-Minutes: 04:15 PM - 04:30 PM

Peak Hour

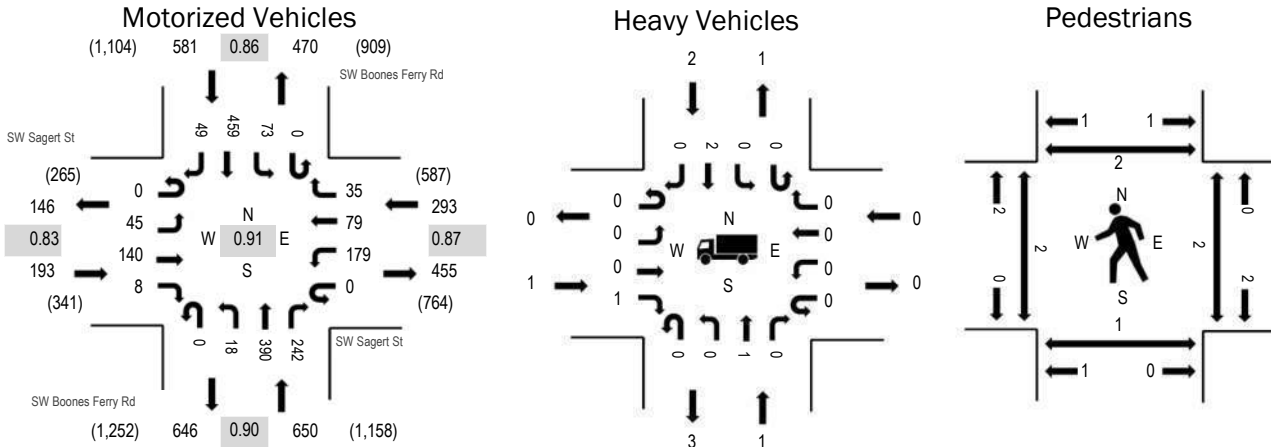

Note: Total study counts contained in parentheses.

	HV%	PHF
EB	0.5%	0.83
WB	0.0%	0.87
NB	0.2%	0.90
SB	0.3%	0.86
All	0.2%	0.91

Traffic Counts - Motorized Vehicles

Interval Start Time	SW Sagert St Eastbound				SW Sagert St Westbound				SW Boones Ferry Rd Northbound				SW Boones Ferry Rd Southbound				Total	Rolling Hour
	U-Turn	Left	Thru	Right	U-Turn	Left	Thru	Right	U-Turn	Left	Thru	Right	U-Turn	Left	Thru	Right		
4:00 PM	0	3	11	0	0	15	7	3	0	0	30	17	0	6	29	1	122	1,717
4:05 PM	0	3	9	1	0	13	5	0	0	4	35	24	0	6	41	2	143	1,714
4:10 PM	0	3	12	0	0	16	7	1	0	0	31	20	0	7	47	3	147	1,705
4:15 PM	0	1	8	0	0	22	7	4	0	4	39	17	0	8	36	2	148	1,689
4:20 PM	0	4	5	2	0	14	11	3	0	1	35	20	0	7	56	5	163	1,692
4:25 PM	0	7	16	1	0	14	7	0	0	2	38	24	0	5	37	9	160	1,666
4:30 PM	0	4	10	1	0	16	6	6	0	0	29	28	0	5	30	6	141	1,657
4:35 PM	0	1	13	2	0	9	4	6	0	1	35	17	0	4	46	4	142	1,619
4:40 PM	0	3	21	1	0	15	5	3	0	0	29	14	0	6	40	6	143	1,591
4:45 PM	0	3	13	0	0	15	6	2	0	2	30	19	0	5	26	5	126	1,583
4:50 PM	0	7	6	0	0	17	6	3	0	0	30	22	0	10	38	3	142	1,569
4:55 PM	0	6	16	0	0	13	8	4	0	4	29	20	0	4	33	3	140	1,512
5:00 PM	0	3	5	0	0	13	3	4	0	0	28	18	0	7	34	4	119	1,473
5:05 PM	0	2	23	1	0	12	3	2	0	1	26	18	0	1	43	2	134	
5:10 PM	0	4	14	1	0	15	7	5	0	1	35	13	0	4	29	3	131	
5:15 PM	0	6	12	2	0	18	6	4	0	3	38	16	0	4	39	3	151	
5:20 PM	0	1	9	1	0	17	9	5	0	1	29	15	0	4	41	5	137	
5:25 PM	0	9	9	0	0	15	8	5	0	0	35	14	0	9	44	3	151	
5:30 PM	0	1	4	0	0	11	6	7	0	0	23	12	0	6	30	3	103	
5:35 PM	0	2	7	0	0	15	3	5	0	1	23	14	0	3	38	3	114	
5:40 PM	0	4	5	0	0	14	6	7	0	1	30	13	0	5	45	5	135	
5:45 PM	0	5	8	0	0	17	7	3	0	0	27	10	0	3	29	3	112	
5:50 PM	0	3	3	1	0	12	3	3	0	0	24	6	0	4	23	3	85	
5:55 PM	0	3	0	0	0	14	7	3	0	2	25	6	0	5	32	4	101	
Count Total	0	88	239	14	0	352	147	88	0	28	733	397	0	128	886	90	3,190	
Peak Hour	0	45	140	8	0	179	79	35	0	18	390	242	0	73	459	49	1,717	

Traffic Counts - Heavy Vehicles, Bicycles on Road, and Pedestrians/Bicycles on Crosswalk

Interval Start Time	Heavy Vehicles					Interval Start Time	Bicycles on Roadway					Interval Start Time	Pedestrians/Bicycles on Crosswalk				
	EB	NB	WB	SB	Total		EB	NB	WB	SB	Total		EB	NB	WB	SB	Total
4:00 PM	0	0	0	0	0	4:00 PM	0	0	0	0	0	4:00 PM	0	0	0	0	0
4:05 PM	0	0	0	0	0	4:05 PM	0	1	0	0	1	4:05 PM	0	0	2	0	2
4:10 PM	0	0	0	1	1	4:10 PM	0	0	0	0	0	4:10 PM	1	1	0	0	2
4:15 PM	0	0	0	0	0	4:15 PM	0	0	0	0	0	4:15 PM	0	0	0	0	0
4:20 PM	0	0	0	0	0	4:20 PM	0	0	0	0	0	4:20 PM	0	0	0	0	0
4:25 PM	0	1	0	0	1	4:25 PM	0	0	0	0	0	4:25 PM	0	0	0	0	0
4:30 PM	1	0	0	0	1	4:30 PM	0	0	0	0	0	4:30 PM	1	0	0	0	1
4:35 PM	0	0	0	0	0	4:35 PM	0	0	0	0	0	4:35 PM	0	0	0	1	1
4:40 PM	0	0	0	0	0	4:40 PM	0	0	0	0	0	4:40 PM	0	0	0	0	0
4:45 PM	0	0	0	0	0	4:45 PM	0	1	0	0	1	4:45 PM	0	0	0	1	1
4:50 PM	0	0	0	0	0	4:50 PM	0	0	0	2	2	4:50 PM	0	0	0	1	1
4:55 PM	0	0	0	1	1	4:55 PM	0	0	0	0	0	4:55 PM	0	0	0	0	0
5:00 PM	0	0	0	0	0	5:00 PM	0	0	0	0	0	5:00 PM	0	0	0	0	0
5:05 PM	0	0	0	0	0	5:05 PM	0	0	0	0	0	5:05 PM	0	0	0	0	0
5:10 PM	0	0	0	0	0	5:10 PM	0	1	0	0	1	5:10 PM	0	0	0	0	0
5:15 PM	0	0	0	0	0	5:15 PM	0	0	0	0	0	5:15 PM	0	0	1	0	1
5:20 PM	0	0	0	0	0	5:20 PM	0	0	0	0	0	5:20 PM	0	0	0	0	0
5:25 PM	0	0	0	0	0	5:25 PM	0	0	0	0	0	5:25 PM	0	0	2	0	2
5:30 PM	0	1	0	0	1	5:30 PM	0	0	0	0	0	5:30 PM	0	0	0	0	0
5:35 PM	0	0	0	0	0	5:35 PM	0	0	0	0	0	5:35 PM	0	0	0	0	0
5:40 PM	0	0	0	0	0	5:40 PM	0	0	0	0	0	5:40 PM	0	0	1	1	2
5:45 PM	0	0	0	0	0	5:45 PM	0	0	0	0	0	5:45 PM	2	2	0	0	4
5:50 PM	0	0	0	0	0	5:50 PM	0	0	0	0	0	5:50 PM	0	0	0	0	0
5:55 PM	0	0	0	0	0	5:55 PM	0	0	0	0	0	5:55 PM	2	0	0	0	2
Count Total	1	2	0	2	5	Count Total	0	3	0	2	5	Count Total	6	3	6	4	19
Peak Hour	1	1	0	2	4	Peak Hour	0	2	0	2	4	Peak Hour	2	1	2	3	8

LOCATION: SW Boones Ferry Rd -- SW Avery St
CITY/STATE: Washington, OR

QC JOB #: 15109509
DATE: Tue, Oct 29 2019

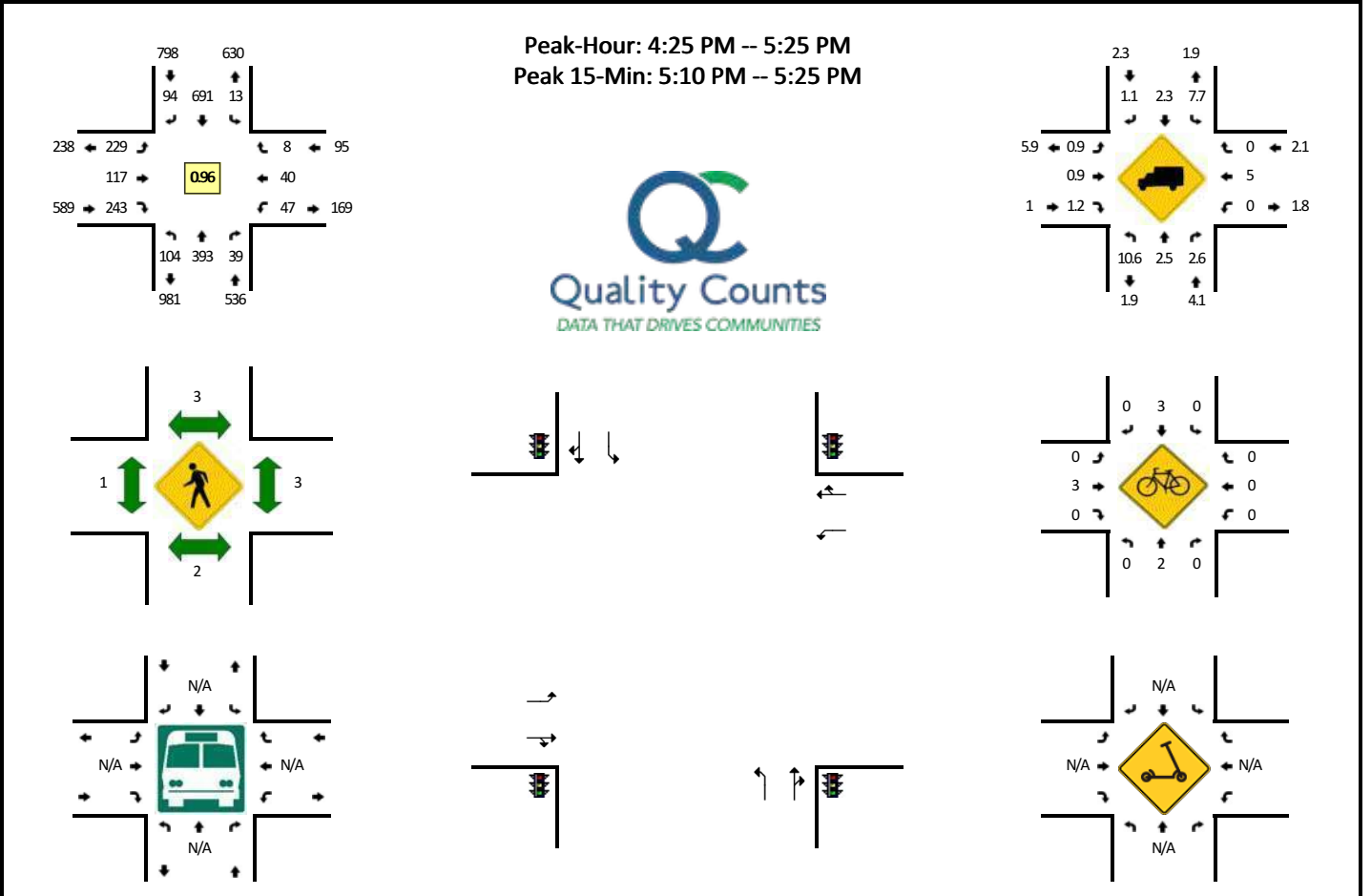

5-Min Count Period Beginning At	SW Boones Ferry Rd (Northbound)				SW Boones Ferry Rd (Southbound)				SW Avery St (Eastbound)				SW Avery St (Westbound)				Total	Hourly Totals
	Left	Thru	Right	U	Left	Thru	Right	U	Left	Thru	Right	U	Left	Thru	Right	U		
4:00 PM	8	30	1	0	0	45	7	0	17	4	12	0	1	2	0	0	127	
4:05 PM	3	34	3	0	0	61	2	0	22	9	26	0	3	4	0	0	167	
4:10 PM	4	23	6	0	1	38	9	0	32	11	26	0	5	7	0	0	162	
4:15 PM	5	33	3	0	1	72	8	0	9	8	19	0	1	2	1	0	162	
4:20 PM	12	23	6	0	0	53	2	0	23	11	25	0	1	1	1	0	158	
4:25 PM	3	49	0	0	0	70	8	0	23	8	9	0	5	4	1	0	180	
4:30 PM	15	37	2	0	1	54	9	0	22	3	12	0	2	5	0	0	162	
4:35 PM	7	21	2	0	1	55	6	0	27	17	23	0	4	5	0	0	168	
4:40 PM	6	27	5	0	0	65	7	0	17	9	20	0	3	1	1	0	161	
4:45 PM	10	26	5	0	0	56	4	0	19	11	26	0	6	3	3	0	169	
4:50 PM	8	31	1	0	0	57	10	0	15	8	12	0	4	6	0	0	152	
4:55 PM	10	46	5	0	2	56	7	0	13	8	11	0	4	5	0	0	167	1935
5:00 PM	6	28	4	0	4	47	6	0	21	10	37	0	5	3	1	0	172	1980
5:05 PM	9	27	6	0	1	61	10	0	18	6	17	0	6	3	0	0	164	1977
5:10 PM	5	25	3	0	1	53	8	0	19	14	28	0	2	3	1	0	162	1977
5:15 PM	13	39	5	0	2	64	6	0	13	13	19	0	1	2	0	0	177	1992
5:20 PM	12	37	1	0	1	53	13	0	22	10	29	0	5	0	1	0	184	2018
5:25 PM	6	28	5	0	2	63	11	0	12	6	25	0	2	1	1	0	162	2000
5:30 PM	13	23	1	0	3	57	9	0	14	11	15	0	2	6	1	0	155	1993
5:35 PM	9	40	3	0	0	77	11	0	11	4	15	0	1	6	0	0	177	2002
5:40 PM	23	38	0	0	1	41	5	0	17	6	22	0	2	5	2	0	162	2003
5:45 PM	14	32	6	0	2	54	6	0	12	4	17	0	1	4	1	0	153	1987
5:50 PM	15	33	2	0	1	65	6	0	10	1	10	0	0	6	1	0	150	1985
5:55 PM	17	29	1	0	1	46	9	0	17	5	25	0	2	3	3	0	158	1976
Peak 15-Min Flowrates	Northbound				Southbound				Eastbound				Westbound				Total	
	Left	Thru	Right	U	Left	Thru	Right	U	Left	Thru	Right	U	Left	Thru	Right	U		
All Vehicles	120	404	36	0	16	680	108	0	216	148	304	0	32	20	8	0	2092	
Heavy Trucks	12	8	4		0	12	0		4	0	4		0	0	0		44	
Buses																		
Pedestrians		0				12				4				0			16	
Bicycles	0	0	0		0	0	0		0	0	0		0	0	0		0	
Scoters																		

Comments:

LOCATION: SW Boones Ferry Rd -- SW Ibach St
CITY/STATE: Tualatin, OR

QC JOB #: 14391102
DATE: Thu, Apr 27 2017

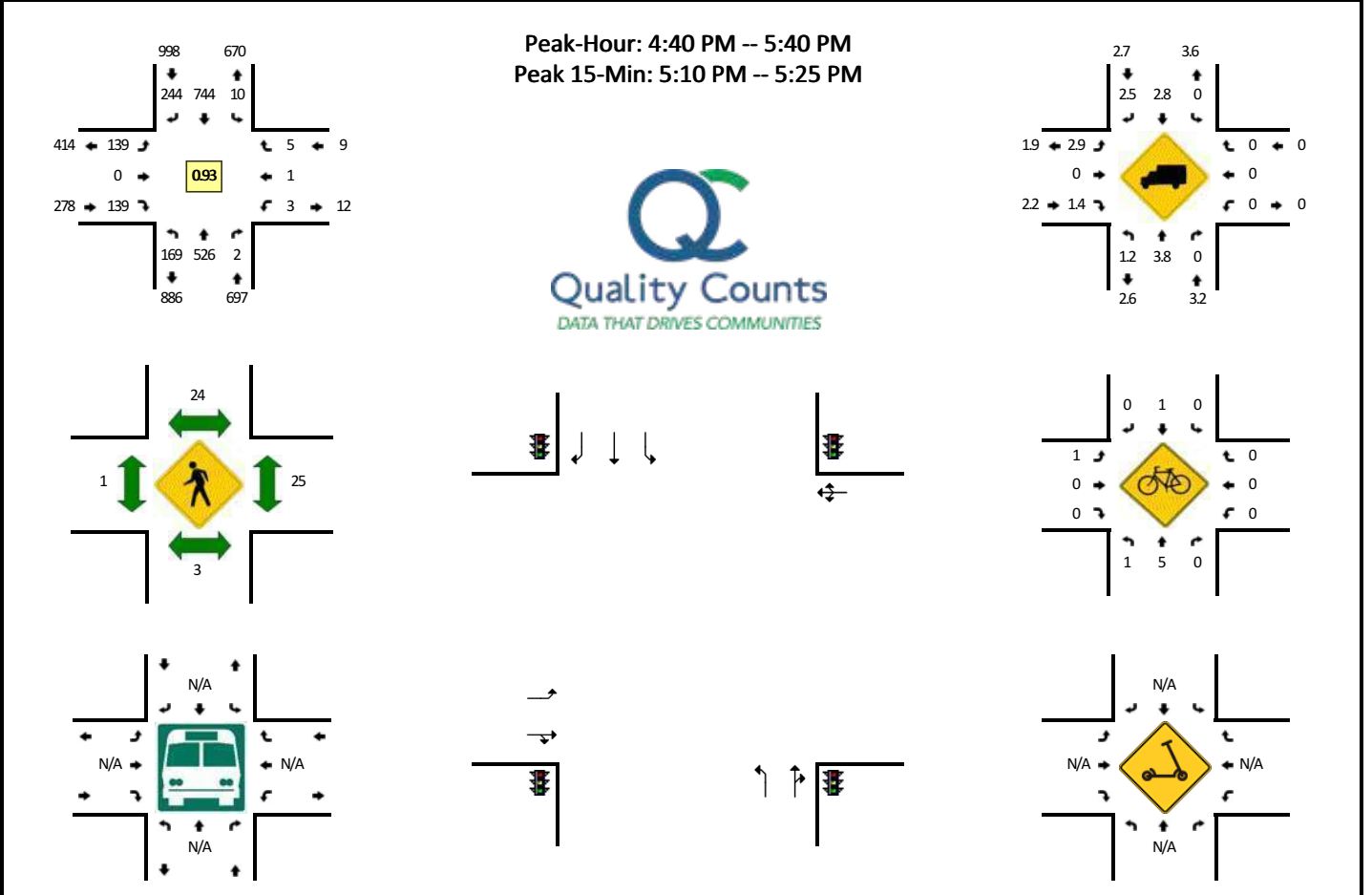

5-Min Count Period Beginning At	SW Boones Ferry Rd (Northbound)				SW Boones Ferry Rd (Southbound)				SW Ibach St (Eastbound)				SW Ibach St (Westbound)				Total	Hourly Totals
	Left	Thru	Right	U	Left	Thru	Right	U	Left	Thru	Right	U	Left	Thru	Right	U		
2:00 PM	3	24	0	0	0	27	11	0	6	0	8	0	0	0	0	0	79	
2:05 PM	9	35	0	0	0	35	8	0	15	0	13	0	0	0	1	0	116	
2:10 PM	2	32	0	0	0	23	11	0	7	0	3	0	0	0	0	0	78	
2:15 PM	6	32	0	0	0	28	12	0	9	0	5	0	0	0	1	0	93	
2:20 PM	4	26	0	0	0	35	11	0	9	0	11	0	0	0	0	0	96	
2:25 PM	10	29	0	0	1	34	6	0	7	0	9	0	0	0	0	0	96	
2:30 PM	8	31	0	0	1	31	7	0	8	0	8	0	0	0	1	0	95	
2:35 PM	2	30	0	0	3	47	9	0	5	0	8	0	0	0	0	0	104	
2:40 PM	5	32	0	0	3	51	14	0	4	0	11	0	1	0	0	0	121	
2:45 PM	5	25	0	0	2	57	18	0	5	0	9	0	0	0	0	0	121	
2:50 PM	13	30	0	0	1	59	12	0	15	1	17	0	1	0	0	0	149	
2:55 PM	9	36	3	0	2	40	10	0	10	2	12	0	1	0	0	0	125	1273
3:00 PM	14	38	3	0	5	44	12	0	7	1	11	0	1	1	0	0	137	1331
3:05 PM	18	54	2	0	1	54	12	0	12	2	4	0	0	0	5	0	164	1379
3:10 PM	25	58	1	0	5	56	11	0	10	4	10	0	1	7	8	0	196	1497
3:15 PM	23	62	0	0	2	52	20	0	4	0	17	0	0	3	8	0	191	1595
3:20 PM	21	78	0	0	0	46	13	0	11	0	13	0	0	0	2	0	184	1683
3:25 PM	12	30	0	0	3	36	19	0	13	0	11	0	0	0	1	0	125	1712
3:30 PM	11	28	0	0	0	51	17	0	7	0	10	0	0	0	0	0	124	1741
3:35 PM	9	49	1	0	0	45	14	0	7	0	20	0	0	1	1	0	147	1784
3:40 PM	9	38	0	0	0	74	13	0	4	0	10	0	1	0	0	0	149	1812
3:45 PM	5	30	0	0	0	54	19	0	18	1	14	0	0	0	0	0	141	1832
3:50 PM	9	33	0	0	0	65	19	0	12	1	15	0	0	0	1	0	155	1838
3:55 PM	6	31	0	0	1	56	15	0	13	0	5	0	1	1	0	0	129	1842
4:00 PM	8	35	0	0	1	54	16	0	11	0	10	0	0	1	0	0	136	1841
4:05 PM	5	53	0	0	0	63	16	0	21	0	11	0	0	0	0	0	169	1846
4:10 PM	4	38	0	0	1	45	12	0	14	1	5	0	1	0	0	0	121	1771
4:15 PM	10	30	1	0	1	72	14	0	16	0	8	0	0	0	1	0	153	1733
4:20 PM	8	34	0	0	1	63	21	0	9	0	13	0	0	0	0	0	149	1698
4:25 PM	10	33	1	0	1	64	11	0	13	0	6	0	0	0	1	0	140	1713
4:30 PM	10	43	0	0	2	44	19	0	8	0	4	0	0	0	1	0	131	1720
4:35 PM	11	39	0	0	0	66	15	0	11	0	13	0	0	0	0	0	155	1728
4:40 PM	8	56	0	0	1	62	9	0	13	0	12	0	1	0	0	0	162	1741
4:45 PM	11	44	0	0	0	68	32	0	9	0	12	0	0	0	0	0	176	1776
4:50 PM	14	39	0	0	2	61	13	0	13	0	22	0	0	0	0	0	164	1785
4:55 PM	16	42	0	0	2	63	21	0	12	0	9	0	0	0	0	0	165	1821
5:00 PM	15	37	0	0	0	63	10	0	14	0	12	0	0	1	1	0	153	1838
5:05 PM	14	38	2	0	1	55	19	0	10	0	13	0	1	0	2	0	155	1824

5-Min Count Period Beginning At	SW Boones Ferry Rd (Northbound)				SW Boones Ferry Rd (Southbound)				SW Ibach St (Eastbound)				SW Ibach St (Westbound)				Total	Hourly Totals
	Left	Thru	Right	U	Left	Thru	Right	U	Left	Thru	Right	U	Left	Thru	Right	U		
5:10 PM	20	47	0	0	1	54	31	0	9	0	8	0	0	0	1	0	171	1874
5:15 PM	12	38	0	0	0	76	27	0	11	0	13	0	0	0	0	0	177	1898
5:20 PM	14	46	0	0	2	72	23	0	15	0	11	0	1	0	0	0	184	1933
5:25 PM	15	56	0	0	1	57	16	0	18	0	5	0	0	0	0	0	168	1961
5:30 PM	13	34	0	0	0	47	25	0	6	0	13	0	0	0	0	0	138	1968
5:35 PM	17	49	0	0	0	66	18	0	9	0	9	0	0	0	1	0	169	1982
5:40 PM	9	40	0	0	1	57	17	0	13	0	12	0	1	0	0	0	150	1970
5:45 PM	12	34	0	0	0	62	19	0	11	1	6	0	1	0	0	0	146	1940
5:50 PM	8	36	0	0	2	57	32	0	11	0	6	0	0	0	1	0	153	1929
5:55 PM	4	34	1	0	1	43	18	0	13	0	6	0	0	0	1	0	121	1885
Peak 15-Min Flowrates	Northbound				Southbound				Eastbound				Westbound				Total	
	Left	Thru	Right	U	Left	Thru	Right	U	Left	Thru	Right	U	Left	Thru	Right	U		
All Vehicles	184	524	0	0	12	808	324	0	140	0	128	0	4	0	4	0	2128	
Heavy Trucks	4	20	0	0	0	28	8	0	0	0	0	0	0	0	0	0	60	
Buses																		
Pedestrians		8				8				4				12			32	
Bicycles	0	4	0		0	4	0		0	0	0		0	0	0		8	
Scoters																		

Comments:

Report generated on 10/7/2020 10:23 AM

SOURCE: Quality Counts, LLC (<http://www.qualitycounts.net>) 1-877-580-2212



(303) 216-2439
www.alltrafficdata.net

Location: 2 SW BOONES FERRY RD & SW IOWA ST PM

Date: Tuesday, September 29, 2020

Peak Hour: 04:35 PM - 05:35 PM

Peak 15-Minutes: 04:45 PM - 05:00 PM

Peak Hour

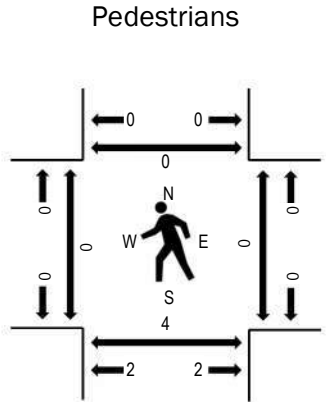
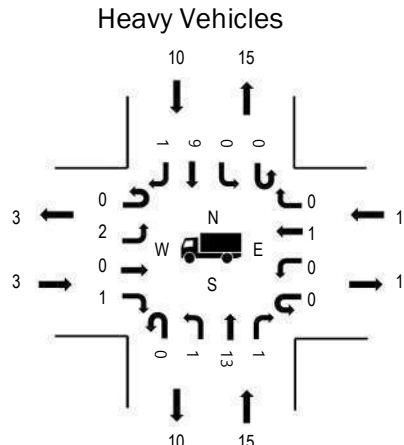
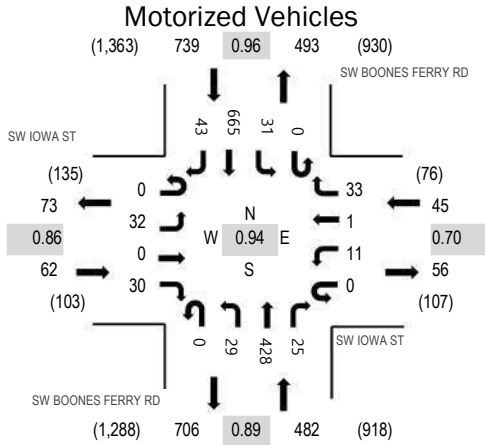

Note: Total study counts contained in parentheses.

	HV%	PHF
EB	4.8%	0.86
WB	2.2%	0.70
NB	3.1%	0.89
SB	1.4%	0.96
All	2.2%	0.94

Traffic Counts - Motorized Vehicles

Interval Start Time	SW IOWA ST Eastbound				SW IOWA ST Westbound				SW BOONES FERRY RD Northbound				SW BOONES FERRY RD Southbound				Total	Rolling Hour
	U-Turn	Left	Thru	Right	U-Turn	Left	Thru	Right	U-Turn	Left	Thru	Right	U-Turn	Left	Thru	Right		
4:00 PM	0	2	0	2	0	0	0	2	0	3	31	0	0	2	48	1	91	1,278
4:05 PM	0	0	0	1	0	2	0	4	0	4	30	0	0	2	41	4	88	1,292
4:10 PM	0	4	0	0	0	1	0	0	0	1	35	1	0	2	51	1	96	1,313
4:15 PM	0	3	0	3	0	1	0	0	0	4	38	2	0	2	63	6	122	1,325
4:20 PM	0	3	0	1	0	1	0	3	0	1	30	6	0	3	48	2	98	1,307
4:25 PM	0	2	0	0	0	1	0	2	0	2	37	1	0	6	50	3	104	1,319
4:30 PM	0	1	0	1	0	1	0	2	0	3	34	1	0	2	55	2	102	1,323
4:35 PM	0	5	0	3	0	2	0	5	0	3	39	1	0	1	55	2	116	1,328
4:40 PM	0	1	0	1	0	0	0	1	0	0	39	2	0	3	56	6	109	1,311
4:45 PM	0	4	0	2	0	1	0	2	0	2	38	3	0	1	56	2	111	1,306
4:50 PM	0	2	0	1	0	0	1	4	0	3	46	4	0	4	55	8	128	1,281
4:55 PM	0	2	0	1	0	4	0	4	0	3	28	3	0	2	61	5	113	1,230
5:00 PM	0	3	0	2	0	0	0	1	0	1	37	2	0	3	55	1	105	1,182
5:05 PM	0	2	0	4	0	0	0	3	0	4	30	2	0	4	58	2	109	
5:10 PM	0	4	0	3	0	0	0	0	0	1	36	2	0	3	53	6	108	
5:15 PM	0	2	0	2	0	1	0	3	0	3	31	0	0	2	57	3	104	
5:20 PM	0	3	0	3	0	1	0	3	0	4	37	3	0	3	50	3	110	
5:25 PM	0	2	0	6	0	0	0	3	0	2	30	2	0	3	58	2	108	
5:30 PM	0	2	0	2	0	2	0	4	0	3	37	1	0	2	51	3	107	
5:35 PM	0	2	0	2	0	0	0	1	0	4	29	2	0	5	50	4	99	
5:40 PM	0	0	0	3	0	0	0	5	0	1	43	2	0	3	43	4	104	
5:45 PM	0	2	0	3	0	0	0	0	0	1	28	1	0	3	46	2	86	
5:50 PM	0	1	0	1	0	0	0	2	0	2	36	1	0	3	30	1	77	
5:55 PM	0	3	0	1	0	0	0	3	0	3	19	0	0	1	32	3	65	
Count Total	0	55	0	48	0	18	1	57	0	58	818	42	0	65	1,222	76	2,460	
Peak Hour	0	32	0	30	0	11	1	33	0	29	428	25	0	31	665	43	1,328	

Traffic Counts - Heavy Vehicles, Bicycles on Road, and Pedestrians/Bicycles on Crosswalk

Interval Start Time	Heavy Vehicles					Interval Start Time	Bicycles on Roadway					Interval Start Time	Pedestrians/Bicycles on Crosswalk				
	EB	NB	WB	SB	Total		EB	NB	WB	SB	Total		EB	NB	WB	SB	Total
4:00 PM	0	4	0	2	6	4:00 PM						4:00 PM	0	0	0	0	0
4:05 PM	0	1	0	0	1	4:05 PM						4:05 PM	0	0	0	0	0
4:10 PM	0	0	0	1	1	4:10 PM						4:10 PM	0	0	0	0	0
4:15 PM	1	1	0	2	4	4:15 PM						4:15 PM	0	0	0	0	0
4:20 PM	0	3	0	1	4	4:20 PM						4:20 PM	0	0	0	0	0
4:25 PM	0	2	0	2	4	4:25 PM						4:25 PM	1	0	0	0	1
4:30 PM	0	0	0	1	1	4:30 PM						4:30 PM	0	0	0	0	0
4:35 PM	0	4	0	0	4	4:35 PM						4:35 PM	0	0	0	0	0
4:40 PM	0	1	0	1	2	4:40 PM						4:40 PM	0	2	0	0	2
4:45 PM	0	2	0	2	4	4:45 PM						4:45 PM	0	0	0	0	0
4:50 PM	0	2	1	2	5	4:50 PM						4:50 PM	0	0	0	0	0
4:55 PM	0	2	0	2	4	4:55 PM						4:55 PM	0	0	0	0	0
5:00 PM	1	1	0	0	2	5:00 PM						5:00 PM	0	0	0	0	0
5:05 PM	1	0	0	0	1	5:05 PM						5:05 PM	0	2	0	0	2
5:10 PM	1	1	0	0	2	5:10 PM						5:10 PM	0	0	0	0	0
5:15 PM	0	0	0	1	1	5:15 PM						5:15 PM	0	0	0	0	0
5:20 PM	0	0	0	0	0	5:20 PM						5:20 PM	0	0	0	0	0
5:25 PM	0	1	0	1	2	5:25 PM						5:25 PM	0	0	0	0	0
5:30 PM	0	1	0	1	2	5:30 PM						5:30 PM	0	0	0	0	0
5:35 PM	0	0	0	1	1	5:35 PM						5:35 PM	0	0	0	0	0
5:40 PM	0	2	0	2	4	5:40 PM						5:40 PM	1	0	0	0	1
5:45 PM	0	1	0	0	1	5:45 PM						5:45 PM	0	0	0	1	1
5:50 PM	0	2	0	0	2	5:50 PM						5:50 PM	0	0	0	0	0
5:55 PM	0	0	0	0	0	5:55 PM						5:55 PM	0	0	1	0	1
Count Total	4	31	1	22	58	Count Total						Count Total	2	4	1	1	8
Peak Hour	3	15	1	10	29	Peak Hour						Peak Hour	0	4	0	0	4



(303) 216-2439
www.alltrafficdata.net

Location: 3 SW BOONES FERRY RD & SW NORWOOD RD PM

Date: Tuesday, September 29, 2020

Peak Hour: 04:10 PM - 05:10 PM

Peak 15-Minutes: 04:40 PM - 04:55 PM

Peak Hour

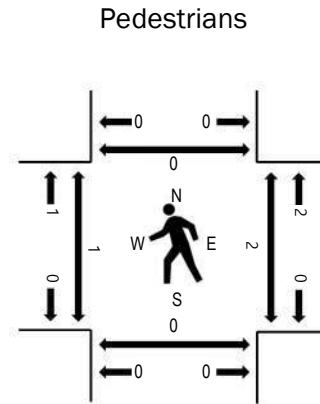
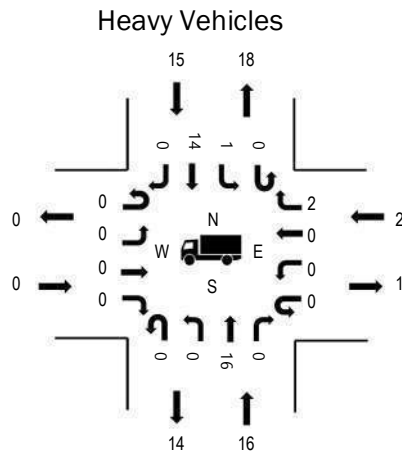
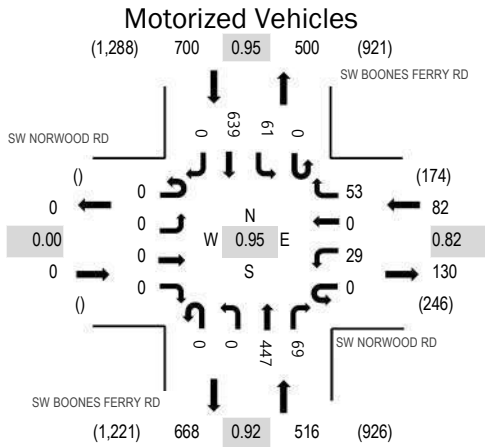

Note: Total study counts contained in parentheses.

	HV%	PHF
EB	0.0%	0.00
WB	2.4%	0.82
NB	3.1%	0.92
SB	2.1%	0.95
All	2.5%	0.95

Traffic Counts - Motorized Vehicles

Interval Start Time	SW NORWOOD RD Eastbound				SW NORWOOD RD Westbound				SW BOONES FERRY RD Northbound				SW BOONES FERRY RD Southbound				Total	Rolling Hour
	U-Turn	Left	Thru	Right	U-Turn	Left	Thru	Right	U-Turn	Left	Thru	Right	U-Turn	Left	Thru	Right		
4:00 PM	0	0	0	0	0	5	0	5	0	0	31	4	0	2	48	0	95	1,255
4:05 PM	0	0	0	0	0	4	0	4	0	0	26	4	0	7	34	0	79	1,272
4:10 PM	0	0	0	0	0	4	0	6	0	0	39	4	0	8	49	0	110	1,298
4:15 PM	0	0	0	0	0	3	0	3	0	0	41	7	0	9	63	0	126	1,282
4:20 PM	0	0	0	0	0	0	0	4	0	0	32	4	0	6	44	0	90	1,260
4:25 PM	0	0	0	0	0	2	0	3	0	0	40	3	0	5	44	0	97	1,286
4:30 PM	0	0	0	0	0	1	0	5	0	0	35	5	0	3	53	0	102	1,291
4:35 PM	0	0	0	0	0	2	0	5	0	0	36	5	0	4	55	0	107	1,291
4:40 PM	0	0	0	0	0	3	0	5	0	0	34	8	0	4	54	0	108	1,271
4:45 PM	0	0	0	0	0	3	0	5	0	0	49	6	0	2	59	0	124	1,261
4:50 PM	0	0	0	0	0	4	0	5	0	0	35	8	0	3	56	0	111	1,221
4:55 PM	0	0	0	0	0	1	0	5	0	0	30	3	0	5	62	0	106	1,183
5:00 PM	0	0	0	0	0	3	0	4	0	0	38	12	0	6	49	0	112	1,133
5:05 PM	0	0	0	0	0	3	0	3	0	0	38	4	0	6	51	0	105	
5:10 PM	0	0	0	0	0	2	0	5	0	0	26	4	0	5	52	0	94	
5:15 PM	0	0	0	0	0	4	0	6	0	0	29	6	0	4	55	0	104	
5:20 PM	0	0	0	0	0	4	0	6	0	0	39	5	0	6	56	0	116	
5:25 PM	0	0	0	0	0	0	0	2	0	0	35	6	0	7	52	0	102	
5:30 PM	0	0	0	0	0	2	0	6	0	0	34	4	0	8	48	0	102	
5:35 PM	0	0	0	0	0	1	0	5	0	0	36	2	0	4	39	0	87	
5:40 PM	0	0	0	0	0	2	0	7	0	0	29	7	0	11	42	0	98	
5:45 PM	0	0	0	0	0	3	0	6	0	0	24	7	0	3	41	0	84	
5:50 PM	0	0	0	0	0	2	0	6	0	0	34	1	0	1	29	0	73	
5:55 PM	0	0	0	0	0	1	0	4	0	0	16	1	0	7	27	0	56	
Count Total	0	0	0	0	0	59	0	115	0	0	806	120	0	126	1,162	0	2,388	
Peak Hour	0	0	0	0	0	29	0	53	0	0	447	69	0	61	639	0	1,298	

Data Provided by K-D-N.com 503-594-4224

N/S street	SW Boones Ferry Rd
E/W street	SW Norwood Rd
City, State	Tualatin OR
Site Notes	
Location	45.353654 - -122.7747
Start Date	Tuesday, October 22, 2019
Start Time	04:00:00 PM
Weather	
Study ID #	
Peak Hour Start	04:50:00 PM
Peak 15 Min Start	05:00:00 PM
PHF (15-Min Int)	0.94

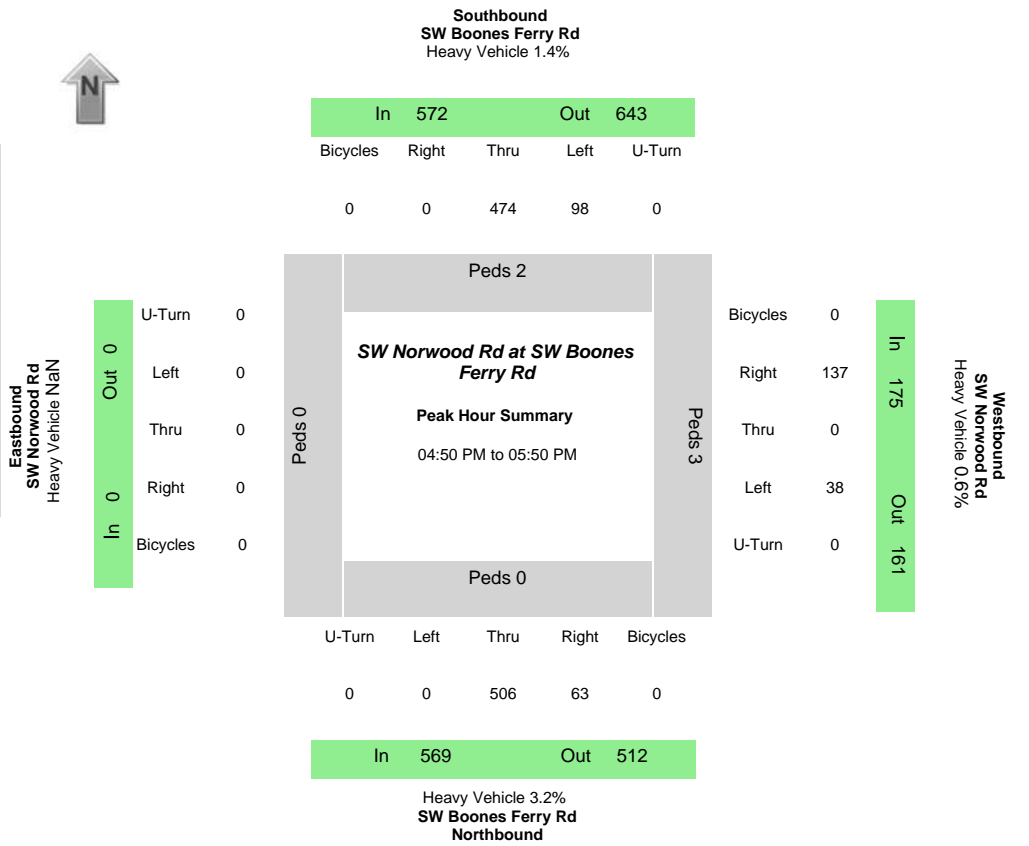

Peak-Hour Volumes (PHV)																							
Northbound				Southbound				Eastbound				Westbound				Entering				Leaving			
Left	Thru	Right	Uturn	Left	Thru	Right	Uturn	Left	Thru	Right	Uturn	Left	Thru	Right	Uturn	NB	SB	EB	WB	NB	SB	EB	WB
0	506	63	0	98	474	0	0	0	0	0	0	38	0	137	0	569	572	0	175	512	643	0	161
Percent Heavy Vehicles																							
0.0%	3.6%	0.0%	0.0%	1.0%	1.5%	0.0%	0.0%	0.0%	0.0%	0.0%	0.0%	2.6%	0.0%	0.0%	0.0%	3.2%	1.4%	NaN	0.6%	1.6%	2.8%	NaN	0.6%

PHV- Bicycles														PHV - Pedestrians							
Northbound				Southbound				Eastbound				Westbound				in Crosswalk					
Left	Thru	Right	Uturn	Left	Thru	Right	Uturn	Left	Thru	Right	Uturn	Left	Thru	Right	Uturn	Sum	NB	SB	EB	WB	Sum
0	0	0	0	0	0	0	0	0	0	0	0	0	0	0	0	0	0	2	0	3	5

Time	Northbound SW Boones Ferry Rd				Southbound SW Boones Ferry Rd				Eastbound SW Norwood Rd				Westbound SW Norwood Rd				15 Min Sum	1 HR Sum
	Left	Thru	Right	Uturn	Left	Thru	Right	Uturn	Left	Thru	Right	Uturn	Left	Thru	Right	Uturn		
04:00:00 PM	0	45	4	0	14	58	0	0	0	0	0	0	4	0	7	0		
04:05:00 PM	0	28	11	0	6	47	0	0	0	0	0	0	4	0	5	0		
04:10:00 PM	0	25	6	0	13	63	0	0	0	0	0	0	5	0	5	0	350	
04:15:00 PM	0	24	3	0	4	52	0	0	0	0	0	0	2	0	2	0	305	
04:20:00 PM	0	32	0	0	7	35	0	0	0	0	0	0	0	0	9	0	287	
04:25:00 PM	0	23	3	0	4	44	0	0	0	0	0	0	0	0	1	0	245	
04:30:00 PM	0	29	3	0	4	41	0	0	0	0	0	0	1	0	7	0	243	
04:35:00 PM	0	28	7	0	6	36	0	0	0	0	0	0	1	0	5	0	243	
04:40:00 PM	0	33	8	0	5	51	0	0	0	0	0	0	3	0	11	0	279	
04:45:00 PM	0	40	6	0	11	22	0	0	0	0	0	0	4	0	13	0	290	
04:50:00 PM	0	43	6	0	9	39	0	0	0	0	0	0	7	0	13	0	324	
04:55:00 PM	0	36	6	0	10	39	0	0	0	0	0	0	3	0	7	0	314	1188
05:00:00 PM	0	38	2	0	14	42	0	0	0	0	0	0	1	0	6	0	321	1159
05:05:00 PM	0	38	4	0	11	46	0	0	0	0	0	0	5	0	13	0	321	1175
05:10:00 PM	0	56	6	0	5	51	0	0	0	0	0	0	3	0	9	0	350	1188
05:15:00 PM	0	39	5	0	3	42	0	0	0	0	0	0	2	0	10	0	348	1202
05:20:00 PM	0	50	7	0	9	30	0	0	0	0	0	0	2	0	8	0	337	1225
05:25:00 PM	0	44	2	0	7	40	0	0	0	0	0	0	2	0	12	0	314	1257
05:30:00 PM	0	30	4	0	5	30	0	0	0	0	0	0	6	0	17	0	305	1264
05:35:00 PM	0	47	6	0	5	35	0	0	0	0	0	0	4	0	9	0	305	1287
05:40:00 PM	0	44	4	0	13	48	0	0	0	0	0	0	0	0	16	0	323	1301
05:45:00 PM	0	41	11	0	7	32	0	0	0	0	0	0	3	0	17	0	342	1316
05:50:00 PM	0	40	9	0	11	21	0	0	0	0	0	0	2	0	10	0	329	1292
05:55:00 PM	0	49	9	0	4	29	0	0	0	0	0	0	6	0	11	0	312	1299



(303) 216-2439
www.alltrafficdata.net

Location: 1 SW BOONES FERRY RD & SW DAY RD PM

Date: Tuesday, March 30, 2021

Peak Hour: 04:00 PM - 05:00 PM

Peak 15-Minutes: 04:10 PM - 04:25 PM

Peak Hour

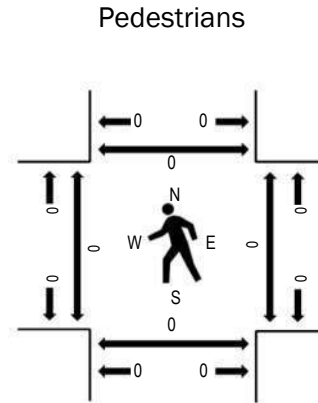
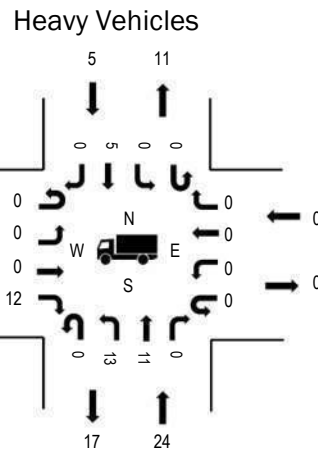
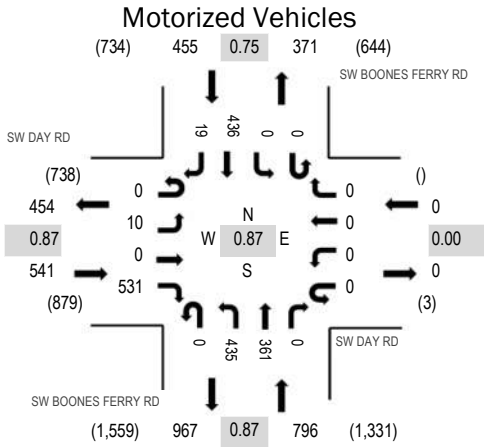

Note: Total study counts contained in parentheses.

	HV%	PHF
EB	2.2%	0.87
WB	0.0%	0.00
NB	3.0%	0.87
SB	1.1%	0.75
All	2.3%	0.87

Traffic Counts - Motorized Vehicles

Interval Start Time	SW DAY RD Eastbound				SW DAY RD Westbound				SW BOONES FERRY RD Northbound				SW BOONES FERRY RD Southbound				Total	Rolling Hour
	U-Turn	Left	Thru	Right	U-Turn	Left	Thru	Right	U-Turn	Left	Thru	Right	U-Turn	Left	Thru	Right		
4:00 PM	0	2	0	56	0	0	0	0	0	53	29	0	0	0	44	2	186	1,792
4:05 PM	0	0	0	48	0	0	0	0	0	42	40	0	0	0	35	2	167	1,723
4:10 PM	0	1	0	49	0	0	0	0	0	31	32	0	0	0	41	2	156	1,678
4:15 PM	0	1	0	47	0	0	0	0	0	41	42	0	0	0	61	0	192	1,614
4:20 PM	0	2	0	50	0	0	0	0	0	33	37	0	0	0	46	1	169	1,541
4:25 PM	0	1	0	49	0	0	0	0	0	34	24	0	0	0	27	1	136	1,461
4:30 PM	0	0	0	37	0	0	0	0	0	27	24	0	0	0	24	0	112	1,411
4:35 PM	0	0	0	38	0	0	0	0	0	33	21	0	0	0	33	2	127	1,388
4:40 PM	0	0	0	43	0	0	0	0	0	34	25	0	0	0	32	3	137	1,342
4:45 PM	0	0	0	37	0	0	0	0	0	50	36	0	0	0	36	0	159	1,295
4:50 PM	0	2	0	41	0	0	0	0	0	33	27	0	0	0	26	2	131	1,213
4:55 PM	0	1	0	36	0	0	0	0	0	24	24	0	0	0	31	4	120	1,166
5:00 PM	0	0	0	38	0	0	0	0	0	28	28	0	0	0	20	3	117	1,152
5:05 PM	0	1	0	27	0	0	0	0	0	44	31	0	0	0	18	1	122	
5:10 PM	0	0	0	34	0	0	0	0	0	19	17	0	0	0	22	0	92	
5:15 PM	0	1	0	40	0	0	0	0	0	25	20	0	0	0	32	1	119	
5:20 PM	0	0	0	21	0	0	0	0	0	26	23	0	0	0	19	0	89	
5:25 PM	0	1	0	23	0	0	0	0	0	15	22	0	0	0	25	0	86	
5:30 PM	0	1	0	31	0	0	0	0	0	22	9	0	0	0	26	0	89	
5:35 PM	0	1	0	20	0	0	0	0	0	13	17	0	0	0	30	0	81	
5:40 PM	0	1	0	30	0	0	0	0	0	21	15	0	0	0	20	3	90	
5:45 PM	0	0	0	19	0	0	0	0	0	16	20	0	0	0	20	2	77	
5:50 PM	0	0	2	16	0	0	0	0	0	19	29	0	0	0	18	0	84	
5:55 PM	0	4	1	26	0	0	0	0	0	24	32	0	0	0	17	2	106	
Count Total	0	20	3	856	0	0	0	0	0	707	624	0	0	0	703	31	2,944	
Peak Hour	0	10	0	531	0	0	0	0	0	435	361	0	0	0	436	19	1,792	

Traffic Counts - Heavy Vehicles, Bicycles on Road, and Pedestrians/Bicycles on Crosswalk

Interval Start Time	Heavy Vehicles					Interval Start Time	Bicycles on Roadway					Interval Start Time	Pedestrians/Bicycles on Crosswalk				
	EB	NB	WB	SB	Total		EB	NB	WB	SB	Total		EB	NB	WB	SB	Total
4:00 PM	2	3	0	0	5	4:00 PM	0	0	0	0	0	4:00 PM	0	0	0	0	0
4:05 PM	0	2	0	0	2	4:05 PM	0	0	0	0	0	4:05 PM	0	0	0	0	0
4:10 PM	3	2	0	0	5	4:10 PM	0	0	0	0	0	4:10 PM	0	0	0	0	0
4:15 PM	2	2	0	1	5	4:15 PM	0	0	0	0	0	4:15 PM	0	0	0	0	0
4:20 PM	0	3	0	0	3	4:20 PM	0	0	0	0	0	4:20 PM	0	0	0	0	0
4:25 PM	2	1	0	1	4	4:25 PM	0	0	0	0	0	4:25 PM	0	0	0	0	0
4:30 PM	1	0	0	0	1	4:30 PM	0	0	0	0	0	4:30 PM	0	0	0	0	0
4:35 PM	0	0	0	1	1	4:35 PM	0	0	0	0	0	4:35 PM	0	0	0	0	0
4:40 PM	1	7	0	0	8	4:40 PM	0	0	0	0	0	4:40 PM	0	0	0	0	0
4:45 PM	0	3	0	2	5	4:45 PM	0	0	0	0	0	4:45 PM	0	0	0	0	0
4:50 PM	0	1	0	0	1	4:50 PM	0	0	0	0	0	4:50 PM	0	0	0	0	0
4:55 PM	1	0	0	0	1	4:55 PM	0	0	0	0	0	4:55 PM	0	0	0	0	0
5:00 PM	1	0	0	1	2	5:00 PM	0	0	0	0	0	5:00 PM	0	0	0	0	0
5:05 PM	2	1	0	1	4	5:05 PM	0	0	0	0	0	5:05 PM	0	0	0	0	0
5:10 PM	1	0	0	0	1	5:10 PM	0	0	0	0	0	5:10 PM	0	0	0	0	0
5:15 PM	0	1	0	2	3	5:15 PM	0	0	0	0	0	5:15 PM	0	0	0	0	0
5:20 PM	2	0	0	0	2	5:20 PM	0	0	0	0	0	5:20 PM	0	0	0	0	0
5:25 PM	3	0	0	0	3	5:25 PM	0	0	0	0	0	5:25 PM	0	0	0	0	0
5:30 PM	0	0	0	2	2	5:30 PM	0	0	0	0	0	5:30 PM	0	0	0	0	0
5:35 PM	0	0	0	2	2	5:35 PM	0	0	0	0	0	5:35 PM	0	0	0	0	0
5:40 PM	0	2	0	0	2	5:40 PM	0	0	0	0	0	5:40 PM	0	0	0	0	0
5:45 PM	1	1	0	0	2	5:45 PM	0	0	0	0	0	5:45 PM	0	0	0	0	0
5:50 PM	2	1	0	0	3	5:50 PM	0	0	0	0	0	5:50 PM	0	0	0	0	0
5:55 PM	2	0	0	1	3	5:55 PM	0	0	0	0	0	5:55 PM	0	0	0	0	0
Count Total	26	30	0	14	70	Count Total	0	0	0	0	0	Count Total	0	0	0	0	0
Peak Hour	12	24	0	5	41	Peak Hour	0	0	0	0	0	Peak Hour	0	0	0	0	0



(303) 216-2439
www.alltrafficdata.net

Location: SW Boones Ferry Rd & SW 95th Ave PM

Date: Tuesday, June 8, 2021

Peak Hour: 04:25 PM - 05:25 PM

Peak 15-Minutes: 05:00 PM - 05:15 PM

Peak Hour

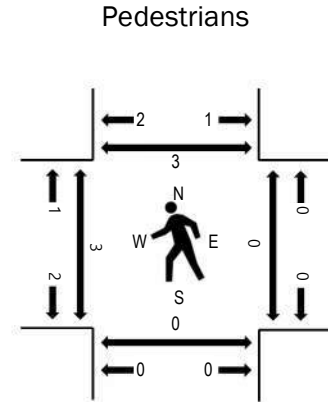
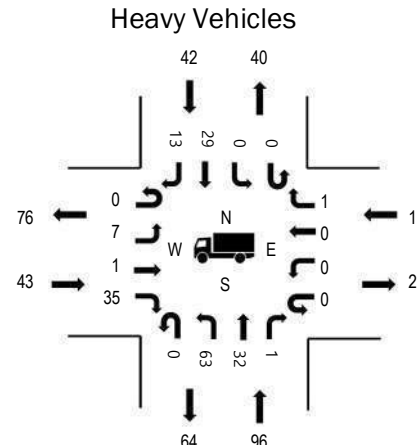
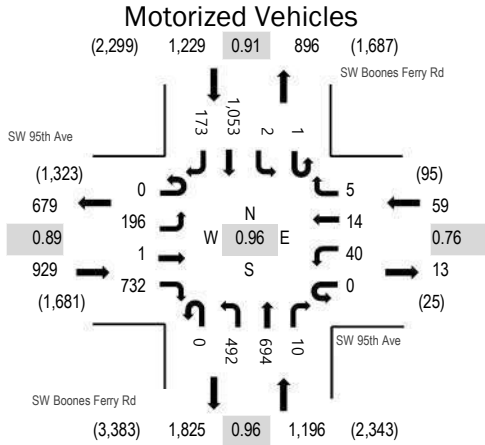

Note: Total study counts contained in parentheses.

	HV%	PHF
EB	4.6%	0.89
WB	1.7%	0.76
NB	8.0%	0.96
SB	3.4%	0.91
All	5.3%	0.96

Traffic Counts - Motorized Vehicles

Interval Start Time	SW 95th Ave Eastbound				SW 95th Ave Westbound				SW Boones Ferry Rd Northbound				SW Boones Ferry Rd Southbound				Total	Rolling Hour
	U-Turn	Left	Thru	Right	U-Turn	Left	Thru	Right	U-Turn	Left	Thru	Right	U-Turn	Left	Thru	Right		
4:00 PM	0	8	0	64	0	2	1	1	0	41	68	0	0	0	93	16	294	3,328
4:05 PM	0	17	0	88	0	7	1	0	0	41	53	1	0	0	84	13	305	3,322
4:10 PM	0	8	0	50	0	1	1	0	0	25	51	2	0	0	115	16	269	3,293
4:15 PM	0	9	1	71	0	3	1	0	0	26	34	2	0	0	72	14	233	3,348
4:20 PM	0	6	0	54	0	4	0	1	0	33	56	1	0	0	72	20	247	3,398
4:25 PM	0	13	0	57	0	1	2	1	0	23	51	0	0	0	100	15	263	3,413
4:30 PM	0	12	0	58	0	1	1	0	0	41	56	1	0	1	81	15	267	3,392
4:35 PM	0	15	0	80	0	4	1	0	0	48	61	2	0	0	84	11	306	3,371
4:40 PM	0	19	0	80	0	5	0	1	0	34	47	1	0	0	86	18	291	3,313
4:45 PM	0	14	0	55	0	4	1	0	0	47	57	3	0	0	94	9	284	3,255
4:50 PM	0	24	0	63	0	2	3	0	0	38	50	0	0	1	83	8	272	3,211
4:55 PM	0	24	0	42	0	2	1	0	0	42	74	1	0	0	90	21	297	3,167
5:00 PM	0	16	0	63	0	8	0	2	0	39	56	0	0	0	89	15	288	3,090
5:05 PM	0	13	0	62	0	4	0	0	0	54	48	1	0	0	83	11	276	
5:10 PM	0	19	1	70	0	5	1	0	0	51	64	1	0	0	97	15	324	
5:15 PM	0	12	0	58	0	2	3	1	0	43	61	0	0	0	81	22	283	
5:20 PM	0	15	0	44	0	2	1	0	0	32	69	0	1	0	85	13	262	
5:25 PM	0	14	0	60	0	1	0	0	0	57	48	1	0	0	49	12	242	
5:30 PM	0	11	1	38	0	3	0	0	0	32	53	1	0	0	87	20	246	
5:35 PM	0	8	0	57	0	1	0	0	0	39	67	0	0	0	63	13	248	
5:40 PM	0	12	0	42	0	1	1	0	0	44	51	0	0	0	72	10	233	
5:45 PM	0	6	0	45	0	2	1	1	0	39	61	1	0	0	71	13	240	
5:50 PM	0	14	0	29	0	1	0	0	0	47	66	0	0	0	63	8	228	
5:55 PM	0	6	0	33	0	0	0	1	0	45	60	1	0	0	60	14	220	
Count Total	0	315	3	1,363	0	66	20	9	0	961	1,362	20	1	2	1,954	342	6,418	
Peak Hour	0	196	1	732	0	40	14	5	0	492	694	10	1	2	1,053	173	3,413	

Location: SW Boones Ferry Rd & SW 95th Ave PM

Traffic Counts - Heavy Vehicles, Bicycles on Road, and Pedestrians/Bicycles on Crosswalk

Interval Start Time	Heavy Vehicles					Interval Start Time	Bicycles on Roadway					Interval Start Time	Pedestrians/Bicycles on Crosswalk				
	EB	NB	WB	SB	Total		EB	NB	WB	SB	Total		EB	NB	WB	SB	Total
4:00 PM	5	9	0	3	17	4:00 PM	0	0	0	0	0	4:00 PM	0	0	0	0	0
4:05 PM	2	4	0	1	7	4:05 PM	0	0	0	0	0	4:05 PM	0	0	0	1	1
4:10 PM	2	7	0	4	13	4:10 PM	0	0	0	0	0	4:10 PM	0	0	0	0	0
4:15 PM	5	3	0	0	8	4:15 PM	0	0	0	0	0	4:15 PM	0	0	0	0	0
4:20 PM	2	11	0	2	15	4:20 PM	0	0	0	0	0	4:20 PM	0	0	0	0	0
4:25 PM	1	9	1	4	15	4:25 PM	0	0	0	0	0	4:25 PM	0	0	0	0	0
4:30 PM	3	14	0	2	19	4:30 PM	0	0	0	0	0	4:30 PM	0	0	0	0	0
4:35 PM	4	6	0	3	13	4:35 PM	0	0	0	0	0	4:35 PM	0	0	0	0	0
4:40 PM	5	8	0	4	17	4:40 PM	0	0	0	0	0	4:40 PM	1	0	0	1	2
4:45 PM	4	8	0	1	13	4:45 PM	0	0	0	0	0	4:45 PM	0	0	0	0	0
4:50 PM	6	5	0	3	14	4:50 PM	0	0	0	0	0	4:50 PM	0	0	0	0	0
4:55 PM	4	5	0	5	14	4:55 PM	0	0	0	0	0	4:55 PM	0	0	0	0	0
5:00 PM	3	11	0	4	18	5:00 PM	1	0	0	0	1	5:00 PM	0	0	0	0	0
5:05 PM	3	10	0	1	14	5:05 PM	0	0	0	0	0	5:05 PM	0	0	0	0	0
5:10 PM	5	7	0	4	16	5:10 PM	0	0	0	0	0	5:10 PM	0	0	0	0	0
5:15 PM	4	8	0	4	16	5:15 PM	0	0	0	0	0	5:15 PM	0	0	0	0	0
5:20 PM	1	5	0	7	13	5:20 PM	1	0	0	0	1	5:20 PM	2	0	0	2	4
5:25 PM	2	7	0	1	10	5:25 PM	0	1	0	0	1	5:25 PM	0	0	0	0	0
5:30 PM	0	11	0	7	18	5:30 PM	0	0	0	0	0	5:30 PM	0	0	0	0	0
5:35 PM	3	4	0	0	7	5:35 PM	0	0	0	0	0	5:35 PM	0	0	0	0	0
5:40 PM	3	2	0	1	6	5:40 PM	0	0	0	0	0	5:40 PM	0	0	0	0	0
5:45 PM	3	10	0	1	14	5:45 PM	0	0	0	0	0	5:45 PM	0	0	0	0	0
5:50 PM	2	6	0	2	10	5:50 PM	1	1	0	0	2	5:50 PM	0	0	0	1	1
5:55 PM	2	3	0	1	6	5:55 PM	0	0	0	0	0	5:55 PM	0	0	0	0	0
Count Total	74	173	1	65	313	Count Total	3	2	0	0	5	Count Total	3	0	0	5	8
Peak Hour	43	96	1	42	182	Peak Hour	2	0	0	0	2	Peak Hour	3	0	0	3	6



(303) 216-2439
www.alltrafficdata.net

Location: 9 I-5 NB RAMPS & SW ELLIGSEN RD PM

Date: Tuesday, September 29, 2020

Peak Hour: 04:40 PM - 05:40 PM

Peak 15-Minutes: 05:05 PM - 05:20 PM

Peak Hour

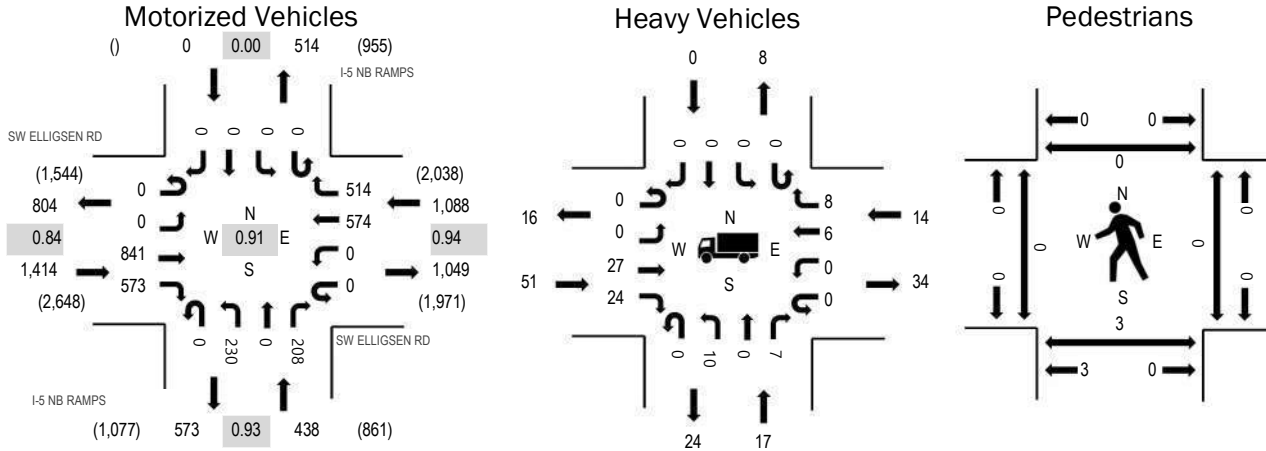

Note: Total study counts contained in parentheses.

	HV%	PHF
EB	3.6%	0.84
WB	1.3%	0.94
NB	3.9%	0.93
SB	0.0%	0.00
All	2.8%	0.91

Traffic Counts - Motorized Vehicles

Interval Start Time	SW ELLIGSEN RD Eastbound				SW ELLIGSEN RD Westbound				I-5 NB RAMPS Northbound				I-5 NB RAMPS Southbound				Total	Rolling Hour
	U-Turn	Left	Thru	Right	U-Turn	Left	Thru	Right	U-Turn	Left	Thru	Right	U-Turn	Left	Thru	Right		
4:00 PM	0	0	68	44	0	0	41	39	0	15	0	17	0	0	0	0	224	2,766
4:05 PM	0	0	62	42	0	0	46	49	0	15	0	16	0	0	0	0	230	2,766
4:10 PM	0	0	62	55	0	0	46	40	0	12	0	15	0	0	0	0	230	2,819
4:15 PM	0	0	49	47	0	0	55	39	0	20	0	21	0	0	0	0	231	2,867
4:20 PM	0	0	64	47	0	0	49	33	0	13	0	21	0	0	0	0	227	2,887
4:25 PM	0	0	66	35	0	0	49	34	0	17	0	14	0	0	0	0	215	2,918
4:30 PM	0	0	62	35	0	0	41	40	0	35	0	13	0	0	0	0	226	2,930
4:35 PM	0	0	65	51	0	0	35	39	0	15	0	14	0	0	0	0	219	2,930
4:40 PM	0	0	69	53	0	0	49	43	0	22	0	18	0	0	0	0	254	2,940
4:45 PM	0	0	75	27	0	0	56	44	0	14	0	20	0	0	0	0	236	2,890
4:50 PM	0	0	65	35	0	0	33	45	0	19	0	17	0	0	0	0	214	2,869
4:55 PM	0	0	73	41	0	0	52	48	0	21	0	25	0	0	0	0	260	2,875
5:00 PM	0	0	57	43	0	0	49	45	0	12	0	18	0	0	0	0	224	2,781
5:05 PM	0	0	76	77	0	0	42	54	0	17	0	17	0	0	0	0	283	
5:10 PM	0	0	76	62	0	0	66	30	0	28	0	16	0	0	0	0	278	
5:15 PM	0	0	80	55	0	0	39	34	0	28	0	15	0	0	0	0	251	
5:20 PM	0	0	75	56	0	0	45	54	0	13	0	15	0	0	0	0	258	
5:25 PM	0	0	59	52	0	0	39	40	0	18	0	19	0	0	0	0	227	
5:30 PM	0	0	65	36	0	0	66	29	0	16	0	14	0	0	0	0	226	
5:35 PM	0	0	71	36	0	0	38	48	0	22	0	14	0	0	0	0	229	
5:40 PM	0	0	66	35	0	0	37	31	0	20	0	15	0	0	0	0	204	
5:45 PM	0	0	63	46	0	0	35	36	0	24	0	11	0	0	0	0	215	
5:50 PM	0	0	60	39	0	0	42	31	0	25	0	23	0	0	0	0	220	
5:55 PM	0	0	43	28	0	0	33	30	0	20	0	12	0	0	0	0	166	
Count Total	0	0	1,571	1,077	0	0	1,083	955	0	461	0	400	0	0	0	0	5,547	
Peak Hour	0	0	841	573	0	0	574	514	0	230	0	208	0	0	0	0	2,940	

Traffic Counts - Heavy Vehicles, Bicycles on Road, and Pedestrians/Bicycles on Crosswalk

Interval Start Time	Heavy Vehicles					Interval Start Time	Bicycles on Roadway					Interval Start Time	Pedestrians/Bicycles on Crosswalk				
	EB	NB	WB	SB	Total		EB	NB	WB	SB	Total		EB	NB	WB	SB	Total
4:00 PM	7	1	5	0	13	4:00 PM						4:00 PM	0	0	0	0	0
4:05 PM	5	4	1	0	10	4:05 PM						4:05 PM	0	0	0	0	0
4:10 PM	6	4	5	0	15	4:10 PM						4:10 PM	0	0	0	0	0
4:15 PM	7	4	1	0	12	4:15 PM						4:15 PM	0	0	0	0	0
4:20 PM	4	2	1	0	7	4:20 PM						4:20 PM	0	1	0	0	1
4:25 PM	3	1	1	0	5	4:25 PM						4:25 PM	0	0	0	0	0
4:30 PM	4	5	1	0	10	4:30 PM						4:30 PM	0	0	0	0	0
4:35 PM	4	4	1	0	9	4:35 PM						4:35 PM	0	0	0	0	0
4:40 PM	5	2	1	0	8	4:40 PM						4:40 PM	0	0	0	0	0
4:45 PM	3	0	3	0	6	4:45 PM						4:45 PM	0	0	0	0	0
4:50 PM	6	1	0	0	7	4:50 PM						4:50 PM	0	0	0	0	0
4:55 PM	6	2	3	0	11	4:55 PM						4:55 PM	0	0	0	0	0
5:00 PM	5	1	0	0	6	5:00 PM						5:00 PM	0	0	0	0	0
5:05 PM	8	2	2	0	12	5:05 PM						5:05 PM	0	0	0	0	0
5:10 PM	5	1	1	0	7	5:10 PM						5:10 PM	0	2	0	0	2
5:15 PM	3	4	0	0	7	5:15 PM						5:15 PM	0	0	0	0	0
5:20 PM	1	1	0	0	2	5:20 PM						5:20 PM	0	1	0	0	1
5:25 PM	3	1	2	0	6	5:25 PM						5:25 PM	0	0	0	0	0
5:30 PM	3	0	2	0	5	5:30 PM						5:30 PM	0	0	0	0	0
5:35 PM	3	2	0	0	5	5:35 PM						5:35 PM	0	0	0	0	0
5:40 PM	2	1	1	0	4	5:40 PM						5:40 PM	0	0	0	0	0
5:45 PM	7	2	1	0	10	5:45 PM						5:45 PM	0	0	0	0	0
5:50 PM	3	3	0	0	6	5:50 PM						5:50 PM	0	0	0	0	0
5:55 PM	3	1	1	0	5	5:55 PM						5:55 PM	0	0	0	0	0
Count Total	106	49	33	0	188	Count Total						Count Total	0	4	0	0	4
Peak Hour	51	17	14	0	82	Peak Hour						Peak Hour	0	3	0	0	3



(303) 216-2439
www.alltrafficdata.net

Location: 8 I-5 SB RAMPS & SW BOONES FERRY RD PM

Date: Tuesday, September 29, 2020

Peak Hour: 04:30 PM - 05:30 PM

Peak 15-Minutes: 05:05 PM - 05:20 PM

Peak Hour

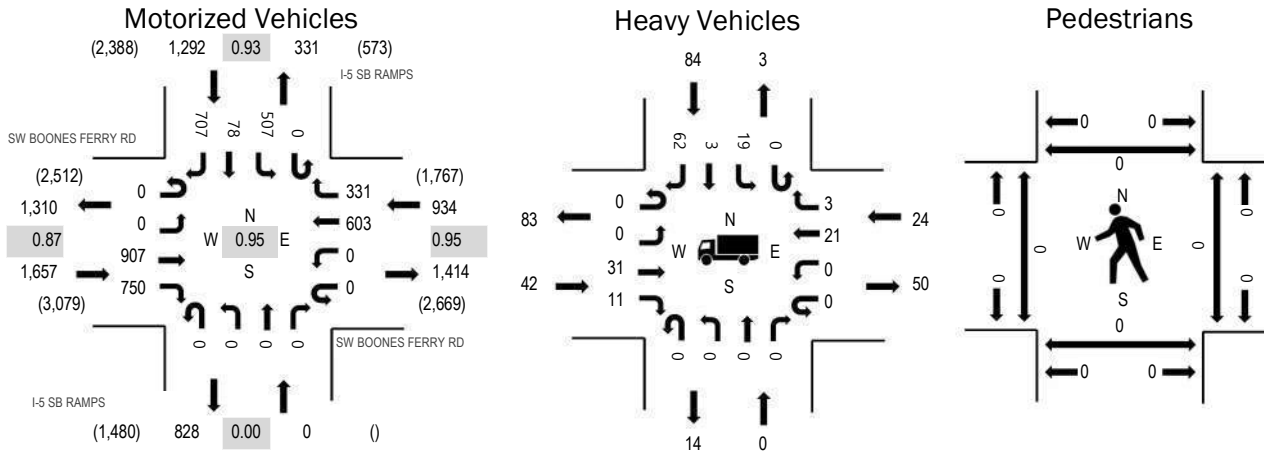

Note: Total study counts contained in parentheses.

	HV%	PHF
EB	2.5%	0.87
WB	2.6%	0.95
NB	0.0%	0.00
SB	6.5%	0.93
All	3.9%	0.95

Traffic Counts - Motorized Vehicles

Interval Start Time	SW BOONES FERRY RD Eastbound				SW BOONES FERRY RD Westbound				I-5 SB RAMPS Northbound				I-5 SB RAMPS Southbound				Total	Rolling Hour
	U-Turn	Left	Thru	Right	U-Turn	Left	Thru	Right	U-Turn	Left	Thru	Right	U-Turn	Left	Thru	Right		
4:00 PM	0	0	79	70	0	0	56	21	0	0	0	0	0	38	4	46	314	3,747
4:05 PM	0	0	79	57	0	0	49	23	0	0	0	0	0	54	6	60	328	3,723
4:10 PM	0	0	67	65	0	0	63	21	0	0	0	0	0	38	4	34	292	3,752
4:15 PM	0	0	61	61	0	0	52	24	0	0	0	0	0	26	2	55	281	3,792
4:20 PM	0	0	86	63	0	0	45	23	0	0	0	0	0	39	1	67	324	3,849
4:25 PM	0	0	60	48	0	0	51	21	0	0	0	0	0	41	0	62	283	3,869
4:30 PM	0	0	71	64	0	0	40	22	0	0	0	0	0	51	6	76	330	3,883
4:35 PM	0	0	83	60	0	0	52	32	0	0	0	0	0	45	4	59	335	3,855
4:40 PM	0	0	64	66	0	0	57	30	0	0	0	0	0	48	9	55	329	3,826
4:45 PM	0	0	52	58	0	0	37	25	0	0	0	0	0	39	10	80	301	3,741
4:50 PM	0	0	61	60	0	0	56	28	0	0	0	0	0	44	7	52	308	3,723
4:55 PM	0	0	66	67	0	0	56	32	0	0	0	0	0	39	8	54	322	3,635
5:00 PM	0	0	83	63	0	0	43	20	0	0	0	0	0	25	6	50	290	3,487
5:05 PM	0	0	104	66	0	0	59	34	0	0	0	0	0	42	7	45	357	
5:10 PM	0	0	95	67	0	0	45	36	0	0	0	0	0	33	4	52	332	
5:15 PM	0	0	83	51	0	0	37	23	0	0	0	0	0	65	5	74	338	
5:20 PM	0	0	88	61	0	0	54	27	0	0	0	0	0	50	5	59	344	
5:25 PM	0	0	57	67	0	0	67	22	0	0	0	0	0	26	7	51	297	
5:30 PM	0	0	70	59	0	0	49	20	0	0	0	0	0	29	8	67	302	
5:35 PM	0	0	69	54	0	0	72	21	0	0	0	0	0	40	3	47	306	
5:40 PM	0	0	64	34	0	0	39	20	0	0	0	0	0	42	1	44	244	
5:45 PM	0	0	75	40	0	0	47	14	0	0	0	0	0	40	4	63	283	
5:50 PM	0	0	42	42	0	0	44	18	0	0	0	0	0	34	2	38	220	
5:55 PM	0	0	53	24	0	0	24	16	0	0	0	0	0	29	0	28	174	
Count Total	0	0	1,712	1,367	0	0	1,194	573	0	0	0	0	0	957	113	1,318	7,234	
Peak Hour	0	0	907	750	0	0	603	331	0	0	0	0	0	507	78	707	3,883	

Traffic Counts - Heavy Vehicles, Bicycles on Road, and Pedestrians/Bicycles on Crosswalk

Interval Start Time	Heavy Vehicles					Interval Start Time	Bicycles on Roadway					Interval Start Time	Pedestrians/Bicycles on Crosswalk				
	EB	NB	WB	SB	Total		EB	NB	WB	SB	Total		EB	NB	WB	SB	Total
4:00 PM	7	0	3	13	23	4:00 PM						4:00 PM	0	0	0	0	0
4:05 PM	5	0	1	9	15	4:05 PM						4:05 PM	0	0	0	0	0
4:10 PM	9	0	2	11	22	4:10 PM						4:10 PM	0	0	0	0	0
4:15 PM	4	0	4	9	17	4:15 PM						4:15 PM	0	0	0	0	0
4:20 PM	5	0	3	6	14	4:20 PM						4:20 PM	0	0	0	0	0
4:25 PM	5	0	4	10	19	4:25 PM						4:25 PM	0	0	0	0	0
4:30 PM	5	0	4	11	20	4:30 PM						4:30 PM	0	0	0	0	0
4:35 PM	4	0	6	7	17	4:35 PM						4:35 PM	0	0	0	0	0
4:40 PM	3	0	0	9	12	4:40 PM						4:40 PM	0	0	0	0	0
4:45 PM	1	0	0	10	11	4:45 PM						4:45 PM	0	0	0	0	0
4:50 PM	5	0	1	8	14	4:50 PM						4:50 PM	0	0	0	0	0
4:55 PM	3	0	2	2	7	4:55 PM						4:55 PM	0	0	0	0	0
5:00 PM	5	0	2	7	14	5:00 PM						5:00 PM	0	0	0	0	0
5:05 PM	4	0	2	8	14	5:05 PM						5:05 PM	0	0	0	0	0
5:10 PM	4	0	3	5	12	5:10 PM						5:10 PM	0	0	0	0	0
5:15 PM	2	0	1	9	12	5:15 PM						5:15 PM	0	0	0	0	0
5:20 PM	4	0	0	7	11	5:20 PM						5:20 PM	0	0	0	0	0
5:25 PM	2	0	3	1	6	5:25 PM						5:25 PM	0	0	0	0	0
5:30 PM	4	0	3	7	14	5:30 PM						5:30 PM	0	0	0	0	0
5:35 PM	4	0	3	4	11	5:35 PM						5:35 PM	0	0	0	0	0
5:40 PM	4	0	0	9	13	5:40 PM						5:40 PM	0	0	0	0	0
5:45 PM	6	0	3	3	12	5:45 PM						5:45 PM	0	0	0	0	0
5:50 PM	1	0	0	3	4	5:50 PM						5:50 PM	0	0	0	0	0
5:55 PM	3	0	1	3	7	5:55 PM						5:55 PM	0	1	0	0	1
Count Total	99	0	51	171	321	Count Total						Count Total	0	1	0	0	1
Peak Hour	42	0	24	84	150	Peak Hour						Peak Hour	0	0	0	0	0



(303) 216-2439

www.alltrafficdata.net

Location: 4 SW 89TH AVE & SW NORWOOD RD PM

Date: Tuesday, September 29, 2020

Peak Hour: 04:45 PM - 05:45 PM

Peak 15-Minutes: 05:20 PM - 05:35 PM

Peak Hour

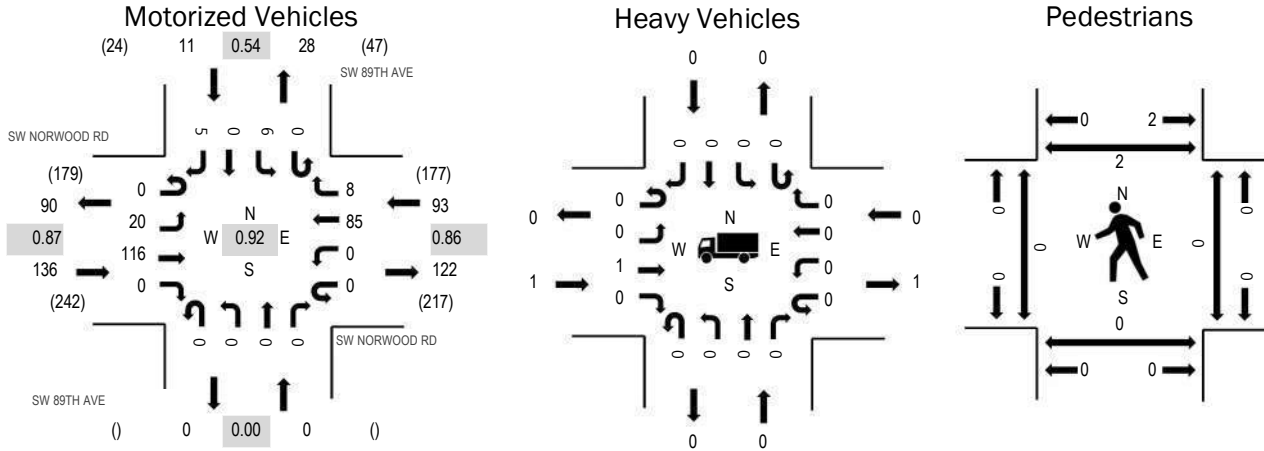

Note: Total study counts contained in parentheses.

	HV%	PHF
EB	0.7%	0.87
WB	0.0%	0.86
NB	0.0%	0.00
SB	0.0%	0.54
All	0.4%	0.92

Traffic Counts - Motorized Vehicles

Interval Start Time	SW NORWOOD RD Eastbound				SW NORWOOD RD Westbound				SW 89TH AVE Northbound				SW 89TH AVE Southbound				Total	Rolling Hour
	U-Turn	Left	Thru	Right	U-Turn	Left	Thru	Right	U-Turn	Left	Thru	Right	U-Turn	Left	Thru	Right		
4:00 PM	0	0	5	0	0	0	6	0	0	0	0	0	0	0	0	2	13	222
4:05 PM	0	0	12	0	0	0	8	0	0	0	0	0	0	1	0	2	23	233
4:10 PM	0	1	10	0	0	0	8	1	0	0	0	0	0	0	0	2	22	227
4:15 PM	0	1	15	0	0	0	7	0	0	0	0	0	0	0	0	1	24	225
4:20 PM	0	1	5	0	0	0	5	1	0	0	0	0	0	0	0	0	12	214
4:25 PM	0	0	14	0	0	0	3	0	0	0	0	0	0	0	0	2	19	226
4:30 PM	0	1	6	0	0	0	8	0	0	0	0	0	0	0	0	0	15	229
4:35 PM	0	1	5	0	0	0	6	0	0	0	0	0	0	0	0	0	12	233
4:40 PM	0	4	6	0	0	0	9	1	0	0	0	0	0	1	0	1	22	233
4:45 PM	0	3	6	0	0	0	9	1	0	0	0	0	0	2	0	0	21	240
4:50 PM	0	0	9	0	0	0	6	1	0	0	0	0	0	0	0	0	16	238
4:55 PM	0	1	12	0	0	0	8	1	0	0	0	0	0	1	0	0	23	230
5:00 PM	0	2	13	0	0	0	7	2	0	0	0	0	0	0	0	0	24	221
5:05 PM	0	1	9	0	0	0	4	1	0	0	0	0	0	1	0	1	17	
5:10 PM	0	2	8	0	0	0	8	0	0	0	0	0	0	0	0	2	20	
5:15 PM	0	1	6	0	0	0	5	0	0	0	0	0	0	0	0	1	13	
5:20 PM	0	1	11	0	0	0	11	0	0	0	0	0	0	1	0	0	24	
5:25 PM	0	1	15	0	0	0	5	0	0	0	0	0	0	0	0	1	22	
5:30 PM	0	4	7	0	0	0	7	0	0	0	0	0	0	1	0	0	19	
5:35 PM	0	0	5	0	0	0	6	1	0	0	0	0	0	0	0	0	12	
5:40 PM	0	4	15	0	0	0	9	1	0	0	0	0	0	0	0	0	29	
5:45 PM	0	3	6	0	0	0	7	2	0	0	0	0	0	1	0	0	19	
5:50 PM	0	1	3	0	0	0	4	0	0	0	0	0	0	0	0	0	8	
5:55 PM	0	1	5	0	0	0	8	0	0	0	0	0	0	0	0	0	14	
Count Total	0	34	208	0	0	0	164	13	0	0	0	0	0	9	0	15	443	
Peak Hour	0	20	116	0	0	0	85	8	0	0	0	0	0	6	0	5	240	

Traffic Counts - Heavy Vehicles, Bicycles on Road, and Pedestrians/Bicycles on Crosswalk

Interval Start Time	Heavy Vehicles					Interval Start Time	Bicycles on Roadway					Interval Start Time	Pedestrians/Bicycles on Crosswalk				
	EB	NB	WB	SB	Total		EB	NB	WB	SB	Total		EB	NB	WB	SB	Total
4:00 PM	0	0	0	0	0	4:00 PM						4:00 PM	0	0	0	0	0
4:05 PM	1	0	0	0	1	4:05 PM						4:05 PM	0	0	0	0	0
4:10 PM	0	0	0	0	0	4:10 PM						4:10 PM	0	0	0	0	0
4:15 PM	1	0	0	0	1	4:15 PM						4:15 PM	0	0	0	0	0
4:20 PM	0	0	0	0	0	4:20 PM						4:20 PM	0	0	0	0	0
4:25 PM	0	0	0	0	0	4:25 PM						4:25 PM	0	0	0	0	0
4:30 PM	0	0	1	0	1	4:30 PM						4:30 PM	0	0	0	0	0
4:35 PM	0	0	0	0	0	4:35 PM						4:35 PM	0	0	0	0	0
4:40 PM	0	0	0	0	0	4:40 PM						4:40 PM	0	0	0	0	0
4:45 PM	0	0	0	0	0	4:45 PM						4:45 PM	0	0	0	0	0
4:50 PM	0	0	0	0	0	4:50 PM						4:50 PM	0	0	0	2	2
4:55 PM	0	0	0	0	0	4:55 PM						4:55 PM	0	0	0	0	0
5:00 PM	0	0	0	0	0	5:00 PM						5:00 PM	0	0	0	0	0
5:05 PM	0	0	0	0	0	5:05 PM						5:05 PM	0	0	0	0	0
5:10 PM	0	0	0	0	0	5:10 PM						5:10 PM	0	0	0	0	0
5:15 PM	0	0	0	0	0	5:15 PM						5:15 PM	0	0	0	0	0
5:20 PM	0	0	0	0	0	5:20 PM						5:20 PM	0	0	0	0	0
5:25 PM	0	0	0	0	0	5:25 PM						5:25 PM	0	0	0	0	0
5:30 PM	0	0	0	0	0	5:30 PM						5:30 PM	0	0	0	0	0
5:35 PM	0	0	0	0	0	5:35 PM						5:35 PM	0	0	0	0	0
5:40 PM	1	0	0	0	1	5:40 PM						5:40 PM	0	0	0	0	0
5:45 PM	0	0	0	0	0	5:45 PM						5:45 PM	0	0	0	0	0
5:50 PM	0	0	0	0	0	5:50 PM						5:50 PM	0	0	0	2	2
5:55 PM	0	0	0	0	0	5:55 PM						5:55 PM	0	0	0	0	0
Count Total	3	0	1	0	4	Count Total						Count Total	0	0	0	4	4
Peak Hour	1	0	0	0	1	Peak Hour						Peak Hour	0	0	0	2	2



(303) 216-2439
www.alltrafficdata.net

Location: 5 SW VERMILLION DR & SW NORWOOD RD PM

Date: Tuesday, September 29, 2020

Peak Hour: 04:45 PM - 05:45 PM

Peak 15-Minutes: 04:45 PM - 05:00 PM

Peak Hour

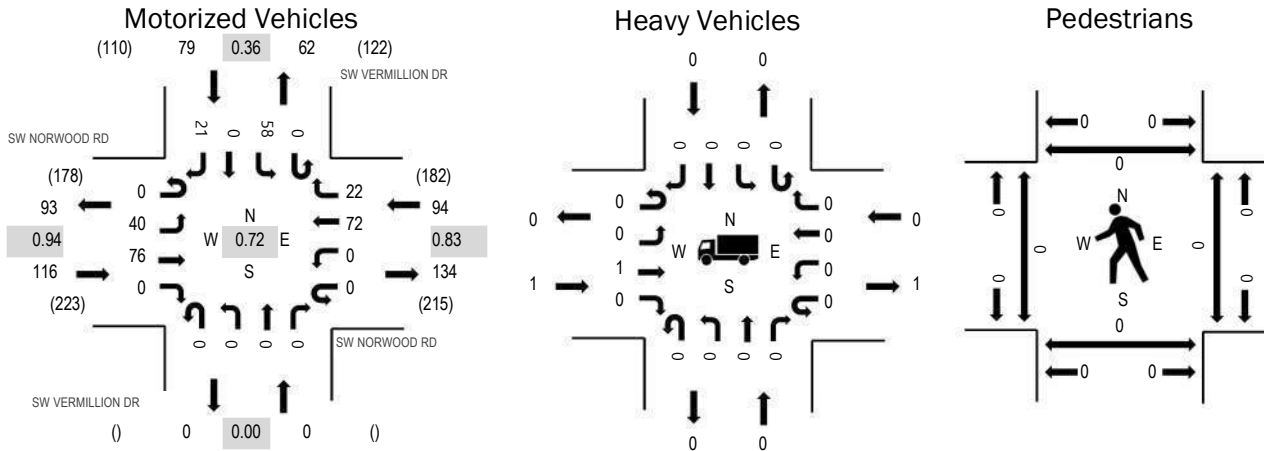

Note: Total study counts contained in parentheses.

	HV%	PHF
EB	0.9%	0.94
WB	0.0%	0.83
NB	0.0%	0.00
SB	0.0%	0.36
All	0.3%	0.72

Traffic Counts - Motorized Vehicles

Interval Start Time	SW NORWOOD RD Eastbound				SW NORWOOD RD Westbound				SW VERMILLION DR Northbound				SW VERMILLION DR Southbound				Total	Rolling Hour
	U-Turn	Left	Thru	Right	U-Turn	Left	Thru	Right	U-Turn	Left	Thru	Right	U-Turn	Left	Thru	Right		
4:00 PM	0	3	3	0	0	0	6	0	0	0	0	0	0	1	0	2	15	270
4:05 PM	0	2	8	0	0	0	6	1	0	0	0	0	0	2	0	1	20	280
4:10 PM	0	7	7	0	0	0	5	2	0	0	0	0	0	2	0	2	25	280
4:15 PM	0	4	9	0	0	0	5	1	0	0	0	0	0	0	0	1	20	277
4:20 PM	0	3	6	0	0	0	8	5	0	0	0	0	0	0	0	1	23	272
4:25 PM	0	2	8	0	0	0	3	0	0	0	0	0	0	0	0	0	13	267
4:30 PM	0	5	6	0	0	0	1	3	0	0	0	0	0	0	0	4	19	279
4:35 PM	0	0	3	0	0	0	8	1	0	0	0	0	0	0	0	1	13	279
4:40 PM	0	5	6	0	0	0	6	2	0	0	0	0	0	1	0	2	22	284
4:45 PM	0	0	6	0	0	0	8	0	0	0	0	0	0	40	0	3	57	289
4:50 PM	0	5	4	0	0	0	6	1	0	0	0	0	0	5	0	2	23	258
4:55 PM	0	3	8	0	0	0	3	1	0	0	0	0	0	3	0	2	20	251
5:00 PM	0	6	5	0	0	0	7	4	0	0	0	0	0	0	0	3	25	245
5:05 PM	0	2	6	0	0	0	5	3	0	0	0	0	0	2	0	2	20	
5:10 PM	0	6	5	0	0	0	5	2	0	0	0	0	0	2	0	2	22	
5:15 PM	0	3	5	0	0	0	3	1	0	0	0	0	0	0	0	3	15	
5:20 PM	0	5	6	0	0	0	6	0	0	0	0	0	0	0	0	1	18	
5:25 PM	0	4	9	0	0	0	10	2	0	0	0	0	0	0	0	0	25	
5:30 PM	0	0	7	0	0	0	8	3	0	0	0	0	0	1	0	0	19	
5:35 PM	0	2	6	0	0	0	4	3	0	0	0	0	0	2	0	1	18	
5:40 PM	0	4	9	0	0	0	7	2	0	0	0	0	0	3	0	2	27	
5:45 PM	0	3	7	0	0	0	7	4	0	0	0	0	0	3	0	2	26	
5:50 PM	0	1	3	0	0	0	6	3	0	0	0	0	0	1	0	2	16	
5:55 PM	0	2	4	0	0	0	4	1	0	0	0	0	0	1	0	2	14	
Count Total	0	77	146	0	0	0	137	45	0	0	0	0	0	69	0	41	515	
Peak Hour	0	40	76	0	0	0	72	22	0	0	0	0	0	58	0	21	289	

Traffic Counts - Heavy Vehicles, Bicycles on Road, and Pedestrians/Bicycles on Crosswalk

Interval Start Time	Heavy Vehicles					Interval Start Time	Bicycles on Roadway					Interval Start Time	Pedestrians/Bicycles on Crosswalk				
	EB	NB	WB	SB	Total		EB	NB	WB	SB	Total		EB	NB	WB	SB	Total
4:00 PM	0	0	0	0	0	4:00 PM						4:00 PM	0	0	0	0	0
4:05 PM	1	0	0	0	1	4:05 PM						4:05 PM	0	0	0	0	0
4:10 PM	0	0	0	0	0	4:10 PM						4:10 PM	0	0	0	0	0
4:15 PM	1	0	0	0	1	4:15 PM						4:15 PM	0	0	0	0	0
4:20 PM	0	0	0	0	0	4:20 PM						4:20 PM	0	0	0	0	0
4:25 PM	0	0	0	0	0	4:25 PM						4:25 PM	0	0	0	0	0
4:30 PM	0	0	0	0	0	4:30 PM						4:30 PM	0	0	0	0	0
4:35 PM	0	0	1	0	1	4:35 PM						4:35 PM	0	0	0	0	0
4:40 PM	0	0	0	0	0	4:40 PM						4:40 PM	0	0	0	0	0
4:45 PM	0	0	0	0	0	4:45 PM						4:45 PM	0	0	0	0	0
4:50 PM	0	0	0	0	0	4:50 PM						4:50 PM	0	0	0	0	0
4:55 PM	0	0	0	0	0	4:55 PM						4:55 PM	0	0	0	0	0
5:00 PM	0	0	0	0	0	5:00 PM						5:00 PM	0	0	0	0	0
5:05 PM	0	0	0	0	0	5:05 PM						5:05 PM	0	0	0	0	0
5:10 PM	0	0	0	0	0	5:10 PM						5:10 PM	0	0	0	0	0
5:15 PM	0	0	0	0	0	5:15 PM						5:15 PM	0	0	0	0	0
5:20 PM	0	0	0	0	0	5:20 PM						5:20 PM	0	0	0	0	0
5:25 PM	0	0	0	0	0	5:25 PM						5:25 PM	0	0	0	0	0
5:30 PM	0	0	0	0	0	5:30 PM						5:30 PM	0	0	0	0	0
5:35 PM	0	0	0	0	0	5:35 PM						5:35 PM	0	0	0	0	0
5:40 PM	1	0	0	0	1	5:40 PM						5:40 PM	0	0	0	0	0
5:45 PM	0	0	0	0	0	5:45 PM						5:45 PM	0	0	0	0	0
5:50 PM	0	0	0	0	0	5:50 PM						5:50 PM	0	0	0	0	0
5:55 PM	0	0	0	0	0	5:55 PM						5:55 PM	0	0	0	0	0
Count Total	3	0	1	0	4	Count Total						Count Total	0	0	0	0	0
Peak Hour	1	0	0	0	1	Peak Hour						Peak Hour	0	0	0	0	0



(303) 216-2439
www.alltrafficdata.net

Location: 6 SW 82ND AVE & SW NORWOOD RD PM

Date: Wednesday, October 7, 2020

Peak Hour: 04:35 PM - 05:35 PM

Peak 15-Minutes: 05:15 PM - 05:30 PM

Peak Hour

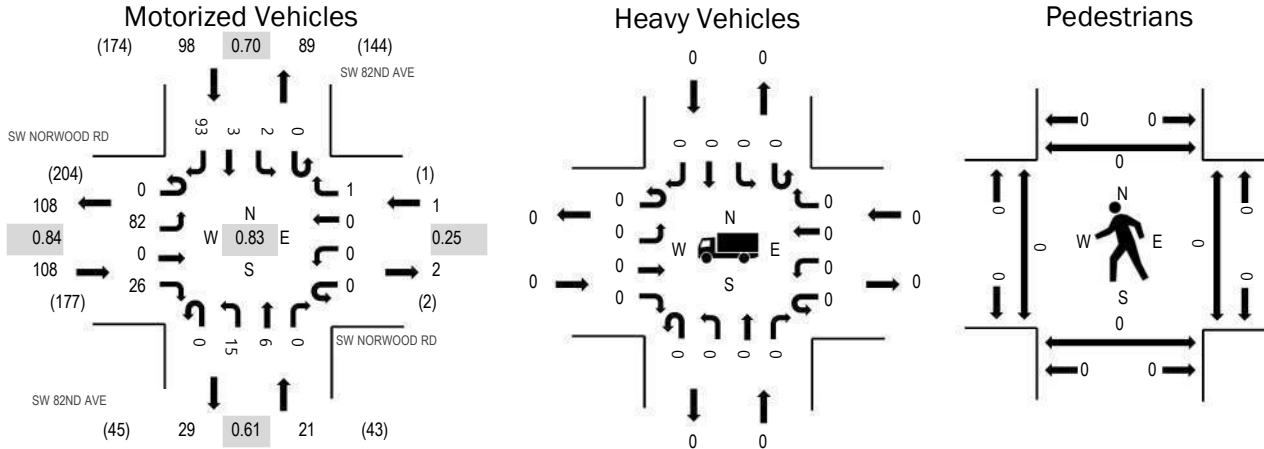

Note: Total study counts contained in parentheses.

	HV%	PHF
EB	0.0%	0.84
WB	0.0%	0.25
NB	0.0%	0.61
SB	0.0%	0.70
All	0.0%	0.83

Traffic Counts - Motorized Vehicles

Interval Start Time	SW NORWOOD RD Eastbound				SW NORWOOD RD Westbound				SW 82ND AVE Northbound				SW 82ND AVE Southbound				Total	Rolling Hour
	U-Turn	Left	Thru	Right	U-Turn	Left	Thru	Right	U-Turn	Left	Thru	Right	U-Turn	Left	Thru	Right		
4:00 PM	0	5	0	3	0	0	0	0	0	4	1	0	0	0	0	4	17	186
4:05 PM	0	5	0	2	0	0	0	0	0	0	0	0	0	0	0	6	13	184
4:10 PM	0	3	0	0	0	0	0	0	0	3	0	0	0	0	0	7	13	194
4:15 PM	0	7	0	2	0	0	0	0	0	1	0	0	0	0	0	5	15	195
4:20 PM	0	6	0	1	0	0	0	0	0	1	0	0	0	0	0	5	13	199
4:25 PM	0	6	0	0	0	0	0	0	0	1	0	0	0	0	1	2	10	215
4:30 PM	0	7	0	0	0	0	0	0	0	2	0	0	0	0	0	7	16	226
4:35 PM	0	7	0	6	0	0	0	0	0	0	0	0	0	0	0	5	18	228
4:40 PM	0	5	0	3	0	0	0	0	0	0	5	0	0	0	1	8	22	222
4:45 PM	0	6	0	1	0	0	0	0	0	1	0	0	0	0	0	12	20	222
4:50 PM	0	9	0	1	0	0	0	0	0	2	0	0	0	0	0	7	19	221
4:55 PM	0	6	0	1	0	0	0	0	0	0	0	0	0	0	0	3	10	211
5:00 PM	0	5	0	0	0	0	0	0	0	3	1	0	0	0	0	6	15	209
5:05 PM	0	8	0	2	0	0	0	0	0	2	0	0	0	0	1	10	23	
5:10 PM	0	6	0	2	0	0	0	0	0	2	0	0	0	0	1	3	14	
5:15 PM	0	6	0	2	0	0	0	0	0	0	0	0	0	0	0	11	19	
5:20 PM	0	9	0	3	0	0	0	1	0	1	0	0	0	2	0	13	29	
5:25 PM	0	9	0	2	0	0	0	0	0	0	0	0	0	0	0	10	21	
5:30 PM	0	6	0	3	0	0	0	0	0	4	0	0	0	0	0	5	18	
5:35 PM	0	5	0	1	0	0	0	0	0	0	0	0	0	0	0	6	12	
5:40 PM	0	4	0	5	0	0	0	0	0	4	0	0	0	0	0	9	22	
5:45 PM	0	4	0	0	0	0	0	0	0	3	0	0	0	0	0	12	19	
5:50 PM	0	0	0	0	0	0	0	0	0	2	0	0	0	0	0	7	9	
5:55 PM	0	2	0	1	0	0	0	0	0	0	0	0	0	0	0	5	8	
Count Total	0	136	0	41	0	0	0	1	0	36	7	0	0	2	4	168	395	
Peak Hour	0	82	0	26	0	0	0	1	0	15	6	0	0	2	3	93	228	

Traffic Counts - Heavy Vehicles, Bicycles on Road, and Pedestrians/Bicycles on Crosswalk

Interval Start Time	Heavy Vehicles					Interval Start Time	Bicycles on Roadway					Interval Start Time	Pedestrians/Bicycles on Crosswalk				
	EB	NB	WB	SB	Total		EB	NB	WB	SB	Total		EB	NB	WB	SB	Total
4:00 PM	0	0	0	0	0	4:00 PM						4:00 PM	0	0	0	0	0
4:05 PM	0	0	0	0	0	4:05 PM						4:05 PM	0	0	0	0	0
4:10 PM	0	0	0	0	0	4:10 PM						4:10 PM	0	0	0	0	0
4:15 PM	0	0	0	0	0	4:15 PM						4:15 PM	0	0	0	0	0
4:20 PM	1	0	0	0	1	4:20 PM						4:20 PM	0	0	0	0	0
4:25 PM	0	0	0	0	0	4:25 PM						4:25 PM	0	0	0	0	0
4:30 PM	0	0	0	0	0	4:30 PM						4:30 PM	0	0	0	0	0
4:35 PM	0	0	0	0	0	4:35 PM						4:35 PM	0	0	0	0	0
4:40 PM	0	0	0	0	0	4:40 PM						4:40 PM	0	0	0	0	0
4:45 PM	0	0	0	0	0	4:45 PM						4:45 PM	0	0	0	0	0
4:50 PM	0	0	0	0	0	4:50 PM						4:50 PM	0	0	0	0	0
4:55 PM	0	0	0	0	0	4:55 PM						4:55 PM	0	0	0	0	0
5:00 PM	0	0	0	0	0	5:00 PM						5:00 PM	0	0	0	0	0
5:05 PM	0	0	0	0	0	5:05 PM						5:05 PM	0	0	0	0	0
5:10 PM	0	0	0	0	0	5:10 PM						5:10 PM	0	0	0	0	0
5:15 PM	0	0	0	0	0	5:15 PM						5:15 PM	0	0	0	0	0
5:20 PM	0	0	0	0	0	5:20 PM						5:20 PM	0	0	0	0	0
5:25 PM	0	0	0	0	0	5:25 PM						5:25 PM	0	0	0	0	0
5:30 PM	0	0	0	0	0	5:30 PM						5:30 PM	0	0	0	0	0
5:35 PM	0	0	0	0	0	5:35 PM						5:35 PM	0	0	0	0	0
5:40 PM	0	0	0	0	0	5:40 PM						5:40 PM	0	0	0	0	0
5:45 PM	0	0	0	0	0	5:45 PM						5:45 PM	0	0	0	0	0
5:50 PM	0	0	0	0	0	5:50 PM						5:50 PM	0	0	0	0	0
5:55 PM	0	0	0	0	0	5:55 PM						5:55 PM	0	0	0	0	0
Count Total	1	0	0	0	1	Count Total						Count Total	0	0	0	0	0
Peak Hour	0	0	0	0	0	Peak Hour						Peak Hour	0	0	0	0	0



(303) 216-2439
www.alltrafficdata.net

Location: 7 SW 65TH AVE & SW NORWOOD RD PM

Date: Tuesday, September 29, 2020

Peak Hour: 04:00 PM - 05:00 PM

Peak 15-Minutes: 04:15 PM - 04:30 PM

Peak Hour

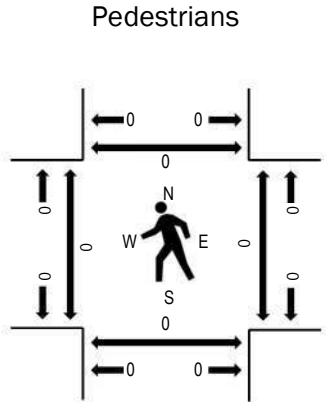
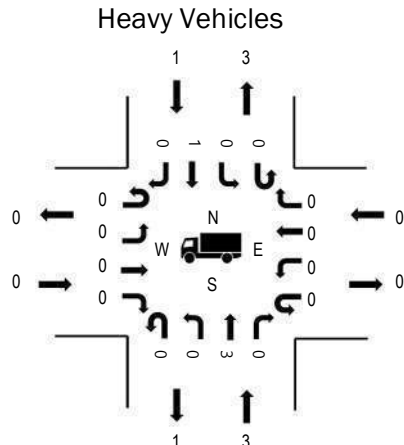
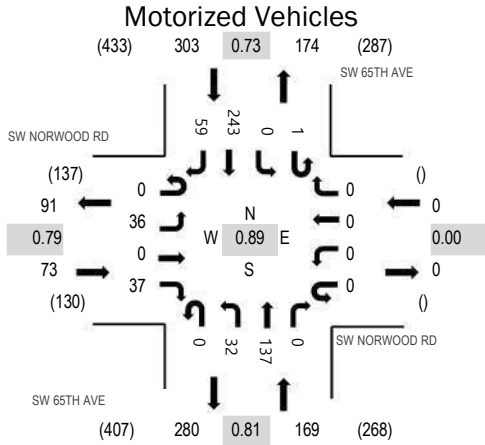

Note: Total study counts contained in parentheses.

	HV%	PHF
EB	0.0%	0.79
WB	0.0%	0.00
NB	1.8%	0.81
SB	0.3%	0.73
All	0.7%	0.89

Traffic Counts - Motorized Vehicles

Interval Start Time	SW NORWOOD RD Eastbound				SW NORWOOD RD Westbound				SW 65TH AVE Northbound				SW 65TH AVE Southbound				Total	Rolling Hour
	U-Turn	Left	Thru	Right	U-Turn	Left	Thru	Right	U-Turn	Left	Thru	Right	U-Turn	Left	Thru	Right		
4:00 PM	0	6	0	5	0	0	0	0	0	3	5	0	0	0	25	2	46	545
4:05 PM	0	2	0	4	0	0	0	0	0	2	9	0	0	0	24	10	51	523
4:10 PM	0	1	0	4	0	0	0	0	0	1	12	0	1	0	28	4	51	498
4:15 PM	0	2	0	5	0	0	0	0	0	3	3	0	0	0	32	5	50	468
4:20 PM	0	2	0	2	0	0	0	0	0	1	13	0	0	0	20	4	42	451
4:25 PM	0	2	0	1	0	0	0	0	0	7	16	0	0	0	29	6	61	438
4:30 PM	0	2	0	3	0	0	0	0	0	0	13	0	0	0	15	5	38	405
4:35 PM	0	10	0	3	0	0	0	0	0	1	13	0	0	0	19	4	50	384
4:40 PM	0	2	0	1	0	0	0	0	0	5	13	0	0	0	12	5	38	356
4:45 PM	0	0	0	7	0	0	0	0	0	4	12	0	0	0	12	9	44	345
4:50 PM	0	6	0	1	0	0	0	0	0	3	17	0	0	0	10	4	41	326
4:55 PM	0	1	0	1	0	0	0	0	0	2	11	0	0	0	17	1	33	303
5:00 PM	0	3	0	3	0	0	0	0	0	0	8	0	0	0	9	1	24	286
5:05 PM	0	2	0	0	0	0	0	0	0	1	16	0	0	0	7	0	26	
5:10 PM	0	0	0	0	0	0	0	0	0	2	10	0	0	0	7	2	21	
5:15 PM	0	3	0	5	0	0	0	0	0	2	5	0	0	0	13	5	33	
5:20 PM	0	5	0	0	0	0	0	0	0	2	7	0	0	0	14	1	29	
5:25 PM	0	2	0	1	0	0	0	0	0	2	6	0	0	0	15	2	28	
5:30 PM	0	2	0	0	0	0	0	0	0	2	2	0	0	0	11	0	17	
5:35 PM	0	2	0	3	0	0	0	0	0	1	2	0	0	0	11	3	22	
5:40 PM	0	4	0	4	0	0	0	0	0	2	6	0	0	0	6	5	27	
5:45 PM	0	10	0	3	0	0	0	0	0	1	4	0	0	0	4	3	25	
5:50 PM	0	1	0	3	0	0	0	0	0	2	7	0	0	0	4	1	18	
5:55 PM	0	1	0	0	0	0	0	0	0	4	5	0	0	0	4	2	16	
Count Total	0	71	0	59	0	0	0	0	0	53	215	0	1	0	348	84	831	
Peak Hour	0	36	0	37	0	0	0	0	0	32	137	0	1	0	243	59	545	

Traffic Counts - Heavy Vehicles, Bicycles on Road, and Pedestrians/Bicycles on Crosswalk

Interval Start Time	Heavy Vehicles					Interval Start Time	Bicycles on Roadway					Interval Start Time	Pedestrians/Bicycles on Crosswalk				
	EB	NB	WB	SB	Total		EB	NB	WB	SB	Total		EB	NB	WB	SB	Total
4:00 PM	0	0	0	0	0	4:00 PM						4:00 PM	0	0	0	0	0
4:05 PM	0	0	0	0	0	4:05 PM						4:05 PM	0	0	0	0	0
4:10 PM	0	0	0	0	0	4:10 PM						4:10 PM	0	0	0	0	0
4:15 PM	0	0	0	0	0	4:15 PM						4:15 PM	0	0	0	0	0
4:20 PM	0	2	0	0	2	4:20 PM						4:20 PM	0	0	0	0	0
4:25 PM	0	1	0	1	2	4:25 PM						4:25 PM	0	0	0	0	0
4:30 PM	0	0	0	0	0	4:30 PM						4:30 PM	0	0	0	0	0
4:35 PM	0	0	0	0	0	4:35 PM						4:35 PM	0	0	0	0	0
4:40 PM	0	0	0	0	0	4:40 PM						4:40 PM	0	0	0	0	0
4:45 PM	0	0	0	0	0	4:45 PM						4:45 PM	0	0	0	0	0
4:50 PM	0	0	0	0	0	4:50 PM						4:50 PM	0	0	0	0	0
4:55 PM	0	0	0	0	0	4:55 PM						4:55 PM	0	0	0	0	0
5:00 PM	0	0	0	0	0	5:00 PM						5:00 PM	0	0	0	0	0
5:05 PM	0	1	0	0	1	5:05 PM						5:05 PM	0	0	0	0	0
5:10 PM	0	0	0	0	0	5:10 PM						5:10 PM	0	0	0	0	0
5:15 PM	0	0	0	0	0	5:15 PM						5:15 PM	0	0	0	0	0
5:20 PM	0	0	0	1	1	5:20 PM						5:20 PM	0	0	0	0	0
5:25 PM	0	0	0	0	0	5:25 PM						5:25 PM	0	0	0	0	0
5:30 PM	0	1	0	0	1	5:30 PM						5:30 PM	0	0	0	0	0
5:35 PM	1	0	0	0	1	5:35 PM						5:35 PM	0	0	0	0	0
5:40 PM	0	0	0	0	0	5:40 PM						5:40 PM	2	2	0	0	4
5:45 PM	0	0	0	0	0	5:45 PM						5:45 PM	0	0	0	0	0
5:50 PM	0	0	0	0	0	5:50 PM						5:50 PM	0	0	0	0	0
5:55 PM	0	0	0	0	0	5:55 PM						5:55 PM	0	0	0	0	0
Count Total	1	5	0	2	8	Count Total						Count Total	2	2	0	0	4
Peak Hour	0	3	0	1	4	Peak Hour						Peak Hour	0	0	0	0	0

Type of report: Tube Count - Volume Data

LOCATION: Norwood Rd 0.1m E of Boones Ferry Rd - #443							QC JOB #: 14908836			
SPECIFIC LOCATION:							DIRECTION: EB			
CITY/STATE: Washington, OR							DATE: Apr 24 2019 - Apr 24 2019			
Start Time	Mon	Tue	Wed 24 Apr 19	Thu	Fri	Average Weekday Hourly Traffic	Sat	Sun	Average Week Hourly Traffic	Average Week Profile
12:00 AM			1			1			1	
01:00 AM			1			1			1	
02:00 AM			4			4			4	
03:00 AM			0			0			0	
04:00 AM			2			2			2	
05:00 AM			6			6			6	
06:00 AM			25			25			25	
07:00 AM			77			77			77	
08:00 AM			78			78			78	
09:00 AM			38			38			38	
10:00 AM			46			46			46	
11:00 AM			55			55			55	
12:00 PM			52			52			52	
01:00 PM			75			75			75	
02:00 PM			74			74			74	
03:00 PM			117			117			117	
04:00 PM			137			137			137	
05:00 PM			141			141			141	
06:00 PM			106			106			106	
07:00 PM			93			93			93	
08:00 PM			67			67			67	
09:00 PM			30			30			30	
10:00 PM			13			13			13	
11:00 PM			8			8			8	
Day Total			1246			1246			1246	
% Weekday Average			100%							
% Week Average			100%			100%				
AM Peak Volume			8:00 AM 78			8:00 AM 78			8:00 AM 78	
PM Peak Volume			5:00 PM 141			5:00 PM 141			5:00 PM 141	

Comments:

Type of report: Tube Count - Volume Data

LOCATION: Norwood Rd 0.1m E of Boones Ferry Rd - #443 SPECIFIC LOCATION: CITY/STATE: Washington, OR							QC JOB #: 14908836 DIRECTION: WB DATE: Apr 24 2019 - Apr 24 2019			
Start Time	Mon	Tue	Wed 24 Apr 19	Thu	Fri	Average Weekday Hourly Traffic	Sat	Sun	Average Week Hourly Traffic	Average Week Profile
12:00 AM			2			2			2	
01:00 AM			2			2			2	
02:00 AM			1			1			1	
03:00 AM			0			0			0	
04:00 AM			8			8			8	
05:00 AM			29			29			29	
06:00 AM			51			51			51	
07:00 AM			125			125			125	
08:00 AM			86			86			86	
09:00 AM			62			62			62	
10:00 AM			35			35			35	
11:00 AM			38			38			38	
12:00 PM			25			25			25	
01:00 PM			32			32			32	
02:00 PM			32			32			32	
03:00 PM			51			51			51	
04:00 PM			95			95			95	
05:00 PM			91			91			91	
06:00 PM			67			67			67	
07:00 PM			87			87			87	
08:00 PM			48			48			48	
09:00 PM			58			58			58	
10:00 PM			2			2			2	
11:00 PM			1			1			1	
Day Total			1028			1028			1028	
% Weekday Average			100%							
% Week Average			100%			100%				
AM Peak Volume			7:00 AM 125			7:00 AM 125			7:00 AM 125	
PM Peak Volume			4:00 PM 95			4:00 PM 95			4:00 PM 95	

Comments:

Type of report: Tube Count - Volume Data

LOCATION: #464 SW Boones Ferry Rd S of SW Norwood Rd SPECIFIC LOCATION: CITY/STATE: Washington, OR							QC JOB #: 14908851 DIRECTION: NB DATE: Apr 24 2019 - Apr 24 2019			
Start Time	Mon	Tue	Wed 24 Apr 19	Thu	Fri	Average Weekday Hourly Traffic	Sat	Sun	Average Week Hourly Traffic	Average Week Profile
12:00 AM			20			20			20	
01:00 AM			11			11			11	
02:00 AM			10			10			10	
03:00 AM			45			45			45	
04:00 AM			180			180			180	
05:00 AM			235			235			235	
06:00 AM			386			386			386	
07:00 AM			493			493			493	
08:00 AM			350			350			350	
09:00 AM			238			238			238	
10:00 AM			221			221			221	
11:00 AM			271			271			271	
12:00 PM			265			265			265	
01:00 PM			306			306			306	
02:00 PM			317			317			317	
03:00 PM			403			403			403	
04:00 PM			448			448			448	
05:00 PM			428			428			428	
06:00 PM			376			376			376	
07:00 PM			252			252			252	
08:00 PM			201			201			201	
09:00 PM			104			104			104	
10:00 PM			59			59			59	
11:00 PM			32			32			32	
Day Total			5651			5651			5651	
% Weekday Average			100%							
% Week Average			100%			100%				
AM Peak Volume			7:00 AM 493			7:00 AM 493			7:00 AM 493	
PM Peak Volume			4:00 PM 448			4:00 PM 448			4:00 PM 448	

Comments:

Type of report: Tube Count - Volume Data

LOCATION: #464 SW Boones Ferry Rd S of SW Norwood Rd							QC JOB #: 14908851			
SPECIFIC LOCATION:							DIRECTION: SB			
CITY/STATE: Washington, OR							DATE: Apr 24 2019 - Apr 24 2019			
Start Time	Mon	Tue	Wed 24 Apr 19	Thu	Fri	Average Weekday Hourly Traffic	Sat	Sun	Average Week Hourly Traffic	Average Week Profile
12:00 AM			52			52			52	
01:00 AM			8			8			8	
02:00 AM			13			13			13	
03:00 AM			17			17			17	
04:00 AM			28			28			28	
05:00 AM			102			102			102	
06:00 AM			186			186			186	
07:00 AM			325			325			325	
08:00 AM			287			287			287	
09:00 AM			270			270			270	
10:00 AM			231			231			231	
11:00 AM			263			263			263	
12:00 PM			269			269			269	
01:00 PM			279			279			279	
02:00 PM			287			287			287	
03:00 PM			431			431			431	
04:00 PM			384			384			384	
05:00 PM			444			444			444	
06:00 PM			349			349			349	
07:00 PM			281			281			281	
08:00 PM			199			199			199	
09:00 PM			121			121			121	
10:00 PM			53			53			53	
11:00 PM			36			36			36	
Day Total			4915			4915			4915	
% Weekday Average			100%							
% Week Average			100%			100%				
AM Peak Volume			7:00 AM 325			7:00 AM 325			7:00 AM 325	
PM Peak Volume			5:00 PM 444			5:00 PM 444			5:00 PM 444	

Comments:

BFR south of Norwood

South

	Day 1	Day 2	Average	1-Hr
7:00 AM	304	277	291	1042
7:15 AM	302	256	279	1000
7:30 AM	236	218	227	962
7:45 AM	254	236	245	961
8:00 AM	218	279	249	907
8:15 AM	239	242	241	827
8:30 AM	231	220	226	745
8:45 AM	174	207	191	678
9:00 AM	169	169	169	653
9:15 AM	168	150	159	
9:30 AM	177	140	159	
9:45 AM	150	182	166	
			291	1042
			PHF	0.90

South

	Day 1	Day 2	Average	1-Hr
4:00 PM	340	292	316	1318
4:15 PM	336	334	335	1319
4:30 PM	334	306	320	1291
4:45 PM	347	346	347	1217
5:00 PM	317	316	317	1090
5:15 PM	315	298	307	980
5:30 PM	264	228	246	855
5:45 PM	235	205	220	804
6:00 PM	221	192	207	730
6:15 PM	164	200	182	
6:30 PM	189	200	195	
6:45 PM	160	132	146	
			347	1319
			PHF	0.95

Location Info	
Location ID	3287
Type	I-SECTION
Functional Class	4
Located On	Boones Ferry Rd
SOUTH OF	S.W. Norwood Road [0.01 miles]
Direction	2-WAY
Community	Tualatin
MPO_ID	
HPMS ID	
Agency	Oregon Traffic Monitoring System

Count Data Info	
Start Date	9/24/2018
End Date	9/25/2018
Start Time	1:45 PM
End Time	1:45 PM
Direction	
Notes	
Count Source	
File Name	OR_Volume_Short_15_2017And2018
Weather	
Study	
Owner	LEGACY
QC Status	Accepted

Interval: 15 mins					
Time	15 Min				Hourly Count
	1st	2nd	3rd	4th	
00:00 - 01:00	38	22	26	18	104
01:00 - 02:00	16	12	24	13	65
02:00 - 03:00	15	29	19	12	75
03:00 - 04:00	22	18	38	31	109
04:00 - 05:00	70	96	108	78	352
05:00 - 06:00	83	134	144	142	503
06:00 - 07:00	154	205	274	286	919
07:00 - 08:00	304	302	236	254	1096
08:00 - 09:00	218	239	231	174	862
09:00 - 10:00	169	168	177	150	664
10:00 - 11:00	156	140	147	151	594
11:00 - 12:00	172	166	198	189	725
12:00 - 13:00	182	192	180	206	760
13:00 - 14:00	197	214	194	200	805
14:00 - 15:00	223	240	276	308	1047
15:00 - 16:00	264	281	310	320	1175
16:00 - 17:00	340	336	334	347	1357
17:00 - 18:00	317	315	264	235	1131
18:00 - 19:00	221	164	189	160	734
19:00 - 20:00	172	139	122	110	543
20:00 - 21:00	106	84	98	74	362
21:00 - 22:00	67	58	53	29	207
22:00 - 23:00	42	36	33	32	143
23:00 - 24:00	34	15	30	27	106
TOTAL					14438

Location Info	
Location ID	3287
Type	I-SECTION
Functional Class	4
Located On	Boones Ferry Rd
SOUTH OF	S.W. Norwood Road [0.01 miles]
Direction	2-WAY
Community	Tualatin
MPO_ID	
HPMS ID	
Agency	Oregon Traffic Monitoring System

Count Data Info	
Start Date	9/25/2018
End Date	9/26/2018
Start Time	1:45 PM
End Time	1:45 PM
Direction	
Notes	
Count Source	
File Name	OR_Volume_Short_15_2017And2018
Weather	
Study	
Owner	LEGACY
QC Status	Accepted

Interval: 15 mins					
Time	15 Min				Hourly Count
	1st	2nd	3rd	4th	
00:00 - 01:00	13	15	4	8	40
01:00 - 02:00	17	11	12	15	55
02:00 - 03:00	30	16	16	17	79
03:00 - 04:00	29	36	31	62	158
04:00 - 05:00	122	86	66	92	366
05:00 - 06:00	168	131	156	190	645
06:00 - 07:00	254	256	286	291	1087
07:00 - 08:00	277	256	218	236	987
08:00 - 09:00	279	242	220	207	948
09:00 - 10:00	169	150	140	182	641
10:00 - 11:00	166	149	170	166	651
11:00 - 12:00	158	182	204	242	786
12:00 - 13:00	199	202	226	253	880
13:00 - 14:00	192	252	235	242	921
14:00 - 15:00	216	290	267	272	1045
15:00 - 16:00	272	370	290	317	1249
16:00 - 17:00	292	334	306	346	1278
17:00 - 18:00	316	298	228	205	1047
18:00 - 19:00	192	200	200	132	724
19:00 - 20:00	151	135	112	114	512
20:00 - 21:00	82	88	90	71	331
21:00 - 22:00	63	48	49	48	208
22:00 - 23:00	28	36	44	34	142
23:00 - 24:00	29	15	46	24	114
TOTAL					14894

Boones Ferry Road at Day Road

	North				South			
	Day 1	Day 2	Average	1-Hr	Day 1	Day 2	Average	1-Hr
7:00 AM	311	310	311	1101	438	484	461	1702
7:15 AM	306	290	298	1042	454	413	434	1620
7:30 AM	280	219	250	982	450	377	414	1568
7:45 AM	254	230	242	945	360	425	393	1518
8:00 AM	216	288	252	902	352	406	379	1443
8:15 AM	244	232	238	819	402	362	382	1405
8:30 AM	210	216	213	745	403	324	364	1354
8:45 AM	186	212	199	686	316	320	318	1329
9:00 AM	165	172	169	646	353	328	341	1319
9:15 AM	170	158	164		309	352	331	
9:30 AM	167	140	154		342	335	339	
9:45 AM	144	174	159		318	297	308	
			311	1101			461	1702
			PHF	0.89			PHF	0.92

	North				South			
	Day 1	Day 2	Average	1-Hr	Day 1	Day 2	Average	1-Hr
4:00 PM	324	312	318	1339	534	502	518	2164
4:15 PM	332	351	342	1317	552	526	539	2205
4:30 PM	355	330	343	1310	530	560	545	2170
4:45 PM	343	329	336	1216	542	582	562	2072
5:00 PM	286	306	296	1110	584	533	559	1908
5:15 PM	354	316	335	1020	546	462	504	1721
5:30 PM	269	229	249	871	501	393	447	1524
5:45 PM	245	214	230	819	426	370	398	1368
6:00 PM	217	194	206	744	400	344	372	1214
6:15 PM	172	199	186		341	273	307	
6:30 PM	190	203	197		344	238	291	
6:45 PM	162	147	155		252	235	244	
			343	1339			562	2205
			PHF	0.98			PHF	0.98

Location Info	
Location ID	15300
Type	I-SECTION
Functional Class	4
Located On	Boones Ferry Rd
NORTH OF	Day Street [0.02 miles]
Direction	2-WAY
Community	Wilsonville
MPO_ID	
HPMS ID	
Agency	Oregon Traffic Monitoring System

Count Data Info	
Start Date	9/24/2018
End Date	9/25/2018
Start Time	2:00 PM
End Time	2:00 PM
Direction	
Notes	
Count Source	
File Name	OR_Volume_Short_15_2017And2018
Weather	
Study	
Owner	LEGACY
QC Status	Accepted

Interval: 15 mins					
Time	15 Min				Hourly Count
	1st	2nd	3rd	4th	
00:00 - 01:00	42	22	27	22	113
01:00 - 02:00	16	15	18	13	62
02:00 - 03:00	16	32	14	18	80
03:00 - 04:00	20	16	38	37	111
04:00 - 05:00	68	102	106	78	354
05:00 - 06:00	81	143	140	153	517
06:00 - 07:00	152	205	285	278	920
07:00 - 08:00	311	306	280	254	1151
08:00 - 09:00	216	244	210	186	856
09:00 - 10:00	165	170	167	144	646
10:00 - 11:00	161	144	146	172	623
11:00 - 12:00	168	183	194	195	740
12:00 - 13:00	184	190	180	202	756
13:00 - 14:00	204	208	204	236	852
14:00 - 15:00	226	244	283	296	1049
15:00 - 16:00	262	296	314	318	1190
16:00 - 17:00	324	332	355	343	1354
17:00 - 18:00	286	354	269	245	1154
18:00 - 19:00	217	172	190	162	741
19:00 - 20:00	184	175	124	108	591
20:00 - 21:00	116	80	114	78	388
21:00 - 22:00	93	64	48	33	238
22:00 - 23:00	46	42	30	32	150
23:00 - 24:00	36	16	27	24	103
TOTAL					14739

Location Info	
Location ID	15300
Type	I-SECTION
Functional Class	4
Located On	Boones Ferry Rd
NORTH OF	Day Street [0.02 miles]
Direction	2-WAY
Community	Wilsonville
MPO_ID	
HPMS ID	
Agency	Oregon Traffic Monitoring System

Count Data Info	
Start Date	9/25/2018
End Date	9/26/2018
Start Time	2:00 PM
End Time	2:00 PM
Direction	
Notes	
Count Source	
File Name	OR_Volume_Short_15_2017And2018
Weather	
Study	
Owner	LEGACY
QC Status	Accepted

Interval: 15 mins					
Time	15 Min				Hourly Count
	1st	2nd	3rd	4th	
00:00 - 01:00	16	15	5	8	44
01:00 - 02:00	16	11	12	18	57
02:00 - 03:00	30	12	16	22	80
03:00 - 04:00	31	36	34	64	165
04:00 - 05:00	121	83	66	96	366
05:00 - 06:00	176	132	143	190	641
06:00 - 07:00	260	250	285	308	1103
07:00 - 08:00	310	290	219	230	1049
08:00 - 09:00	288	232	216	212	948
09:00 - 10:00	172	158	140	174	644
10:00 - 11:00	189	140	164	163	656
11:00 - 12:00	169	168	200	242	779
12:00 - 13:00	207	212	232	248	899
13:00 - 14:00	210	234	237	258	939
14:00 - 15:00	229	296	285	286	1096
15:00 - 16:00	256	393	278	300	1227
16:00 - 17:00	312	351	330	329	1322
17:00 - 18:00	306	316	229	214	1065
18:00 - 19:00	194	199	203	147	743
19:00 - 20:00	161	138	123	112	534
20:00 - 21:00	78	97	100	70	345
21:00 - 22:00	62	48	48	50	208
22:00 - 23:00	28	41	39	37	145
23:00 - 24:00	26	16	44	23	109
TOTAL					15164

Location Info	
Location ID	3289
Type	I-SECTION
Functional Class	4
Located On	BEAVERTON-TUALATIN HIGHWAY NO. 141
SOUTH OF	Day Street [0.05 miles]
Direction	2-WAY
Community	-
MPO_ID	
HPMS ID	
Agency	Oregon Traffic Monitoring System

Count Data Info	
Start Date	8/7/2018
End Date	8/8/2018
Start Time	1:00 PM
End Time	1:00 PM
Direction	
Notes	
Count Source	
File Name	OR_Volume_Short_15_2017And2018
Weather	
Study	
Owner	LEGACY
QC Status	Accepted

Interval: 15 mins					
Time	15 Min				Hourly Count
	1st	2nd	3rd	4th	
00:00 - 01:00	76	43	50	41	210
01:00 - 02:00	24	20	40	29	113
02:00 - 03:00	46	58	42	42	188
03:00 - 04:00	28	46	61	53	188
04:00 - 05:00	113	164	191	150	618
05:00 - 06:00	227	262	352	270	1111
06:00 - 07:00	368	446	450	430	1694
07:00 - 08:00	438	454	450	360	1702
08:00 - 09:00	352	402	403	316	1473
09:00 - 10:00	353	309	342	318	1322
10:00 - 11:00	328	383	382	364	1457
11:00 - 12:00	344	401	346	381	1472
12:00 - 13:00	370	396	386	429	1581
13:00 - 14:00	436	390	400	433	1659
14:00 - 15:00	405	479	472	423	1779
15:00 - 16:00	446	452	546	555	1999
16:00 - 17:00	534	552	530	542	2158
17:00 - 18:00	584	546	501	426	2057
18:00 - 19:00	400	341	344	252	1337
19:00 - 20:00	259	225	176	186	846
20:00 - 21:00	192	160	171	165	688
21:00 - 22:00	143	110	144	135	532
22:00 - 23:00	82	73	64	52	271
23:00 - 24:00	50	59	42	42	193
TOTAL					26648

Location Info	
Location ID	3289_NB
Type	I-SECTION
Functional Class	4
Located On	BEAVERTON-TUALATIN HIGHWAY NO. 141
SOUTH OF	Day Street [0.05 miles]
Direction	NB
Community	-
MPO_ID	
HPMS ID	
Agency	Oregon Traffic Monitoring System

Count Data Info	
Start Date	8/7/2018
End Date	8/8/2018
Start Time	1:00 PM
End Time	1:00 PM
Direction	NB
Notes	
Count Source	
File Name	Vol_Short
Weather	
Study	
Owner	LEGACY
QC Status	Accepted

Interval: 15 mins					
Time	15 Min				Hourly Count
	1st	2nd	3rd	4th	
00:00 - 01:00	30	14	16	16	76
01:00 - 02:00	10	10	20	14	54
02:00 - 03:00	24	18	14	8	64
03:00 - 04:00	16	30	40	39	125
04:00 - 05:00	84	128	144	112	468
05:00 - 06:00	159	182	236	172	749
06:00 - 07:00	234	280	282	232	1028
07:00 - 08:00	236	230	248	188	902
08:00 - 09:00	188	222	207	146	763
09:00 - 10:00	186	145	182	134	647
10:00 - 11:00	152	194	202	179	727
11:00 - 12:00	166	194	190	195	745
12:00 - 13:00	196	160	190	212	758
13:00 - 14:00	232	172	180	181	765
14:00 - 15:00	184	204	212	179	779
15:00 - 16:00	194	192	201	177	764
16:00 - 17:00	242	232	256	246	976
17:00 - 18:00	262	256	220	190	928
18:00 - 19:00	194	173	174	136	677
19:00 - 20:00	140	118	98	100	456
20:00 - 21:00	100	96	86	81	363
21:00 - 22:00	80	66	62	52	260
22:00 - 23:00	34	47	34	28	143
23:00 - 24:00	22	32	25	24	103
TOTAL					13320

Location Info	
Location ID	3289_SB
Type	I-SECTION
Functional Class	4
Located On	BEAVERTON-TUALATIN HIGHWAY NO. 141
SOUTH OF	Day Street [0.05 miles]
Direction	SB
Community	-
MPO_ID	
HPMS ID	
Agency	Oregon Traffic Monitoring System

Count Data Info	
Start Date	8/7/2018
End Date	8/8/2018
Start Time	1:00 PM
End Time	1:00 PM
Direction	SB
Notes	
Count Source	
File Name	Vol_Short
Weather	
Study	
Owner	LEGACY
QC Status	Accepted

Interval: 15 mins					
Time	15 Min				Hourly Count
	1st	2nd	3rd	4th	
00:00 - 01:00	46	29	34	25	134
01:00 - 02:00	14	10	20	15	59
02:00 - 03:00	22	40	28	34	124
03:00 - 04:00	12	16	21	14	63
04:00 - 05:00	29	36	47	38	150
05:00 - 06:00	68	80	116	98	362
06:00 - 07:00	134	166	168	198	666
07:00 - 08:00	202	224	202	172	800
08:00 - 09:00	164	180	196	170	710
09:00 - 10:00	167	164	160	184	675
10:00 - 11:00	176	189	180	185	730
11:00 - 12:00	178	207	156	186	727
12:00 - 13:00	174	236	196	217	823
13:00 - 14:00	204	218	220	252	894
14:00 - 15:00	221	275	260	244	1000
15:00 - 16:00	252	260	345	378	1235
16:00 - 17:00	292	320	274	296	1182
17:00 - 18:00	322	290	281	236	1129
18:00 - 19:00	206	168	170	116	660
19:00 - 20:00	119	107	78	86	390
20:00 - 21:00	92	64	85	84	325
21:00 - 22:00	63	44	82	83	272
22:00 - 23:00	48	26	30	24	128
23:00 - 24:00	28	27	17	18	90
TOTAL					13328

Location Info	
Location ID	3289
Type	I-SECTION
Functional Class	4
Located On	BEAVERTON-TUALATIN HIGHWAY NO. 141
SOUTH OF	Day Street [0.05 miles]
Direction	2-WAY
Community	-
MPO_ID	
HPMS ID	
Agency	Oregon Traffic Monitoring System

Count Data Info	
Start Date	8/8/2018
End Date	8/9/2018
Start Time	1:00 PM
End Time	1:00 PM
Direction	
Notes	
Count Source	
File Name	OR_Volume_Short_15_2017And2018
Weather	
Study	
Owner	LEGACY
QC Status	Accepted

Interval: 15 mins					
Time	15 Min				Hourly Count
	1st	2nd	3rd	4th	
00:00 - 01:00	33	34	35	28	130
01:00 - 02:00	32	22	26	37	117
02:00 - 03:00	47	24	34	29	134
03:00 - 04:00	52	68	84	132	336
04:00 - 05:00	234	140	190	234	798
05:00 - 06:00	337	262	371	444	1414
06:00 - 07:00	516	472	468	456	1912
07:00 - 08:00	484	413	377	425	1699
08:00 - 09:00	406	362	324	320	1412
09:00 - 10:00	328	352	335	297	1312
10:00 - 11:00	400	334	371	368	1473
11:00 - 12:00	358	406	404	418	1586
12:00 - 13:00	388	430	405	380	1603
13:00 - 14:00	422	415	412	457	1706
14:00 - 15:00	449	488	428	463	1828
15:00 - 16:00	504	527	558	506	2095
16:00 - 17:00	502	526	560	582	2170
17:00 - 18:00	533	462	393	370	1758
18:00 - 19:00	344	273	238	235	1090
19:00 - 20:00	219	160	206	159	744
20:00 - 21:00	154	176	180	101	611
21:00 - 22:00	115	108	92	55	370
22:00 - 23:00	79	47	40	73	239
23:00 - 24:00	52	47	57	40	196
TOTAL					26733

Location Info	
Location ID	3289_NB
Type	I-SECTION
Functional Class	4
Located On	BEAVERTON-TUALATIN HIGHWAY NO. 141
SOUTH OF	Day Street [0.05 miles]
Direction	NB
Community	-
MPO_ID	
HPMS ID	
Agency	Oregon Traffic Monitoring System

Count Data Info	
Start Date	8/8/2018
End Date	8/9/2018
Start Time	1:00 PM
End Time	1:00 PM
Direction	NB
Notes	
Count Source	
File Name	Vol_Short
Weather	
Study	
Owner	LEGACY
QC Status	Accepted

Interval: 15 mins					
Time	15 Min				Hourly Count
	1st	2nd	3rd	4th	
00:00 - 01:00	14	8	20	16	58
01:00 - 02:00	10	8	14	18	50
02:00 - 03:00	16	8	14	17	55
03:00 - 04:00	28	42	70	102	242
04:00 - 05:00	183	110	150	176	619
05:00 - 06:00	230	176	255	294	955
06:00 - 07:00	318	300	266	252	1136
07:00 - 08:00	288	244	206	229	967
08:00 - 09:00	234	180	178	156	748
09:00 - 10:00	156	142	158	141	597
10:00 - 11:00	176	170	174	174	694
11:00 - 12:00	186	203	210	202	801
12:00 - 13:00	157	212	181	170	720
13:00 - 14:00	208	203	172	153	736
14:00 - 15:00	203	192	210	188	793
15:00 - 16:00	226	207	234	210	877
16:00 - 17:00	226	236	254	264	980
17:00 - 18:00	247	228	212	180	867
18:00 - 19:00	176	158	128	114	576
19:00 - 20:00	115	80	118	88	401
20:00 - 21:00	80	98	98	53	329
21:00 - 22:00	66	42	32	28	168
22:00 - 23:00	43	25	20	36	124
23:00 - 24:00	24	22	17	14	77
TOTAL					13570

Location Info	
Location ID	3289_SB
Type	I-SECTION
Functional Class	4
Located On	BEAVERTON-TUALATIN HIGHWAY NO. 141
SOUTH OF	Day Street [0.05 miles]
Direction	SB
Community	-
MPO_ID	
HPMS ID	
Agency	Oregon Traffic Monitoring System

Count Data Info	
Start Date	8/8/2018
End Date	8/9/2018
Start Time	1:00 PM
End Time	1:00 PM
Direction	SB
Notes	
Count Source	
File Name	Vol_Short
Weather	
Study	
Owner	LEGACY
QC Status	Accepted

Interval: 15 mins					
Time	15 Min				Hourly Count
	1st	2nd	3rd	4th	
00:00 - 01:00	19	26	15	12	72
01:00 - 02:00	22	14	12	19	67
02:00 - 03:00	31	16	20	12	79
03:00 - 04:00	24	26	14	30	94
04:00 - 05:00	51	30	40	58	179
05:00 - 06:00	107	86	116	150	459
06:00 - 07:00	198	172	202	204	776
07:00 - 08:00	196	169	171	196	732
08:00 - 09:00	172	182	146	164	664
09:00 - 10:00	172	210	177	156	715
10:00 - 11:00	224	164	197	194	779
11:00 - 12:00	172	203	194	216	785
12:00 - 13:00	231	218	224	210	883
13:00 - 14:00	214	212	240	304	970
14:00 - 15:00	246	296	218	275	1035
15:00 - 16:00	278	320	324	296	1218
16:00 - 17:00	276	290	306	318	1190
17:00 - 18:00	286	234	181	190	891
18:00 - 19:00	168	115	110	121	514
19:00 - 20:00	104	80	88	71	343
20:00 - 21:00	74	78	82	48	282
21:00 - 22:00	49	66	60	27	202
22:00 - 23:00	36	22	20	37	115
23:00 - 24:00	28	25	40	26	119
TOTAL					13163

Boones Ferry Road at I-5 SB

	West				East			
	Day 1	Day 2	Average	1-Hr	Day 1	Day 2	Average	1-Hr
7:00 AM	631	681	656	2532	284	300	292	1066
7:15 AM	682	637	660	2471	262	256	259	1008
7:30 AM	693	612	653	2367	256	228	242	961
7:45 AM	577	549	563	2272	270	276	273	923
8:00 AM	565	625	595	2178	216	252	234	859
8:15 AM	560	551	556	2106	224	200	212	851
8:30 AM	622	494	558	2072	186	222	204	860
8:45 AM	462	476	469	2020	198	220	209	858
9:00 AM	542	503	523	2052	238	214	226	884
9:15 AM	502	541	522		222	219	221	
9:30 AM	488	523	506		188	215	202	
9:45 AM	503	499	501		234	236	235	
			660	2532			292	1066
			PHF	0.96			PHF	0.91

	West				East			
	Day 1	Day 2	Average	1-Hr	Day 1	Day 2	Average	1-Hr
4:00 PM	793	712	753	3147	306	260	283	1077
4:15 PM	775	776	776	3218	298	278	288	1017
4:30 PM	792	864	828	3158	278	257	268	919
4:45 PM	766	813	790	2997	213	262	238	821
5:00 PM	863	784	824	2759	215	231	223	720
5:15 PM	773	658	716	2460	184	196	190	648
5:30 PM	700	634	667	2167	172	168	170	610
5:45 PM	609	494	552	1918	110	163	137	561
6:00 PM	610	440	525	1711	142	160	151	538
6:15 PM	449	397	423		160	144	152	
6:30 PM	490	346	418		126	116	121	
6:45 PM	358	332	345		116	112	114	
			828	3218			288	1077
			PHF	0.97			PHF	0.93

Location Info	
Location ID	3290
Type	I-SECTION
Functional Class	4
Located On	BEAVERTON-TUALATIN HIGHWAY NO. 141
EAST OF	Commercial Circle [0.04 miles]
Direction	2-WAY
Community	Wilsonville
MPO_ID	
HPMS ID	
Agency	Oregon Traffic Monitoring System

Count Data Info	
Start Date	8/7/2018
End Date	8/8/2018
Start Time	1:30 PM
End Time	1:30 PM
Direction	
Notes	
Count Source	
File Name	OR_Volume_Short_15_2017And2018
Weather	
Study	
Owner	LEGACY
QC Status	Accepted

Interval: 15 mins					
Time	15 Min				Hourly Count
	1st	2nd	3rd	4th	
00:00 - 01:00	92	74	52	60	278
01:00 - 02:00	42	43	53	59	197
02:00 - 03:00	63	66	68	65	262
03:00 - 04:00	55	81	103	110	349
04:00 - 05:00	144	214	292	229	879
05:00 - 06:00	300	360	520	415	1595
06:00 - 07:00	530	605	683	580	2398
07:00 - 08:00	631	682	693	577	2583
08:00 - 09:00	565	560	622	462	2209
09:00 - 10:00	542	502	488	503	2035
10:00 - 11:00	508	538	492	568	2106
11:00 - 12:00	560	607	617	597	2381
12:00 - 13:00	580	590	552	645	2367
13:00 - 14:00	564	598	557	606	2325
14:00 - 15:00	597	674	680	632	2583
15:00 - 16:00	710	693	756	739	2898
16:00 - 17:00	793	775	792	766	3126
17:00 - 18:00	863	773	700	609	2945
18:00 - 19:00	610	449	490	358	1907
19:00 - 20:00	342	342	277	218	1179
20:00 - 21:00	266	217	222	221	926
21:00 - 22:00	196	175	150	173	694
22:00 - 23:00	132	115	99	91	437
23:00 - 24:00	66	105	68	60	299
TOTAL					38958

Location Info	
Location ID	3290
Type	I-SECTION
Functional Class	4
Located On	BEAVERTON-TUALATIN HIGHWAY NO. 141
EAST OF	Commercial Circle [0.04 miles]
Direction	2-WAY
Community	Wilsonville
MPO_ID	
HPMS ID	
Agency	Oregon Traffic Monitoring System

Count Data Info	
Start Date	8/8/2018
End Date	8/9/2018
Start Time	1:30 PM
End Time	1:30 PM
Direction	
Notes	
Count Source	
File Name	OR_Volume_Short_15_2017And2018
Weather	
Study	
Owner	LEGACY
QC Status	Accepted

Interval: 15 mins					
Time	15 Min				Hourly Count
	1st	2nd	3rd	4th	
00:00 - 01:00	57	57	61	43	218
01:00 - 02:00	50	52	57	44	203
02:00 - 03:00	66	42	60	54	222
03:00 - 04:00	90	105	109	149	453
04:00 - 05:00	267	270	220	309	1066
05:00 - 06:00	429	490	426	549	1894
06:00 - 07:00	683	670	689	684	2726
07:00 - 08:00	681	637	612	549	2479
08:00 - 09:00	625	551	494	476	2146
09:00 - 10:00	503	541	523	499	2066
10:00 - 11:00	554	538	550	584	2226
11:00 - 12:00	592	585	580	648	2405
12:00 - 13:00	568	629	626	530	2353
13:00 - 14:00	564	598	572	634	2368
14:00 - 15:00	630	700	675	708	2713
15:00 - 16:00	678	757	779	787	3001
16:00 - 17:00	712	776	864	813	3165
17:00 - 18:00	784	658	634	494	2570
18:00 - 19:00	440	397	346	332	1515
19:00 - 20:00	312	257	235	224	1028
20:00 - 21:00	224	216	263	204	907
21:00 - 22:00	167	156	118	108	549
22:00 - 23:00	101	117	74	87	379
23:00 - 24:00	89	80	72	88	329
TOTAL					38981

Location Info		Count Data Info	
Location ID	17484	Start Date	5/13/2014
Type	I-SECTION	End Date	5/14/2014
Functional Class		Start Time	8:30 AM
Located On	BEAVERTON-TUALATIN HIGHWAY NO. 141	End Time	8:30 AM
	PACIFIC HIGHWAY-ELLIGSEN ROAD CONN., SW Elligsen Road (OR141), 0.02 mile west of SW Parkway Avenue	Direction	
Direction	2-WAY	Notes	
Community	Wilsonville	Count Source	
MPO_ID		File Name	Pre2017_Vol_Short
HPMS ID		Weather	
Agency	Oregon Traffic Monitoring System	Study	
		Owner	LEGACY
		QC Status	Accepted

Interval: 15 mins					
Time	15 Min				Hourly Count
	1st	2nd	3rd	4th	
00:00 - 01:00	4	8	8	11	31
01:00 - 02:00	3	9	8	14	34
02:00 - 03:00	17	16	8	21	62
03:00 - 04:00	19	31	12	36	98
04:00 - 05:00	37	61	68	174	340
05:00 - 06:00	112	132	155	238	637
06:00 - 07:00	236	265	282	350	1133
07:00 - 08:00	284	262	256	270	1072
08:00 - 09:00	216	224	186	198	824
09:00 - 10:00	238	222	188	234	882
10:00 - 11:00	234	200	224	249	907
11:00 - 12:00	252	273	217	258	1000
12:00 - 13:00	258	232	262	236	988
13:00 - 14:00	211	235	258	236	940
14:00 - 15:00	228	252	220	228	928
15:00 - 16:00	227	264	268	284	1043
16:00 - 17:00	306	298	278	213	1095
17:00 - 18:00	215	184	172	110	681
18:00 - 19:00	142	160	126	116	544
19:00 - 20:00	106	98	85	97	386
20:00 - 21:00	62	82	73	43	260
21:00 - 22:00	52	40	29	35	156
22:00 - 23:00	24	10	7	17	58
23:00 - 24:00	13	7	17	7	44
TOTAL					14143

Location Info		Count Data Info	
Location ID	17484	Start Date	5/14/2014
Type	I-SECTION	End Date	5/15/2014
Functional Class		Start Time	8:30 AM
Located On	BEAVERTON-TUALATIN HIGHWAY NO. 141	End Time	8:30 AM
	PACIFIC HIGHWAY-ELIGSEN ROAD CONN., SW Elligsen Road (OR141), 0.02 mile west of SW Parkway Avenue	Direction	
Direction	2-WAY	Notes	
Community	Wilsonville	Count Source	5222
MPO_ID		File Name	Pre2017_Vol_Short
HPMS ID		Weather	
Agency	Oregon Traffic Monitoring System	Study	
		Owner	
		QC Status	Accepted

Interval: 15 mins					
Time	15 Min				Hourly Count
	1st	2nd	3rd	4th	
00:00 - 01:00	5	10	6	18	39
01:00 - 02:00	5	10	15	24	54
02:00 - 03:00	9	8	12	32	61
03:00 - 04:00	14	25	20	46	105
04:00 - 05:00	40	49	76	151	316
05:00 - 06:00	107	154	169	226	656
06:00 - 07:00	196	264	276	284	1020
07:00 - 08:00	300	256	228	276	1060
08:00 - 09:00	252	200	222	220	894
09:00 - 10:00	214	219	215	236	884
10:00 - 11:00	224	208	240	256	928
11:00 - 12:00	276	246	266	250	1038
12:00 - 13:00	234	254	260	282	1030
13:00 - 14:00	247	242	214	234	937
14:00 - 15:00	220	196	215	220	851
15:00 - 16:00	252	214	218	291	975
16:00 - 17:00	260	278	257	262	1057
17:00 - 18:00	231	196	168	163	758
18:00 - 19:00	160	144	116	112	532
19:00 - 20:00	131	94	106	94	425
20:00 - 21:00	84	78	68	45	275
21:00 - 22:00	42	39	40	35	156
22:00 - 23:00	19	21	13	17	70
23:00 - 24:00	16	7	8	11	42
TOTAL					14163

I-5 Elligson Ramps

	Southbound Off				Northbound Off				Southbound On from West				Southbound On from East			
	Day 1	Day 2	Average	1-Hr	Day 1	Day 2	Average	1-Hr	Day 1	Day 2	Average	1-Hr	Day 1	Day 2	Average	1-Hr
7:00 AM	304	302	303	1451	143	143	523	86	87	87	355	35	35	35	132	
7:15 AM	339	381	360	1492	126	126	489	89	90	90	341	31	31	31	132	
7:30 AM	380	380	380	1475	140	140	461	98	64	81	328	38	38	38	125	
7:45 AM	392	423	408	1418	114	114	450	100	94	97	326	28	28	28	127	
8:00 AM	336	351	344	1351	109	109	443	66	80	73	300	35	35	35	124	
8:15 AM	332	353	343	1294	98	98	441	81	73	77	284	24	24	24	124	
8:30 AM	290	356	323	1231	129	129	436	81	77	79	268	40	40	40	122	
8:45 AM	309	372	341	1159	107	107	412	67	74	71	255	25	25	25	122	
9:00 AM	299	274	287	1044	107	107	434	54	60	57	240	35	35	35	123	
9:15 AM	289	271	280		93	93		55	66	61		22	22	22		
9:30 AM	255	246	251		105	105		49	82	66		40	40	40		
9:45 AM	227	225	226		129	129		58	54	56		26	26	26		
			408	1492			143	523			97	355			40	132
			PHF	0.91			PHF	0.91			PHF	0.91			PHF	0.83

	Northbound On from West				Northbound On from East			
	Day 1	Day 2	Average	1-Hr	Day 1	Day 2	Average	1-Hr
7:00 AM	82	73	78	321	149	149	149	549
7:15 AM	89	82	86	323	128	128	128	531
7:30 AM	73	63	68	330	137	137	137	520
7:45 AM	81	96	89	371	135	135	135	498
8:00 AM	79	81	80	373	131	131	131	487
8:15 AM	86	100	93	393	117	117	117	466
8:30 AM	116	101	109	398	115	115	115	484
8:45 AM	80	101	91	428	124	124	124	496
9:00 AM	97	102	100	465	110	110	110	492
9:15 AM	92	103	98		135	135	135	
9:30 AM	130	148	139		127	127	127	
9:45 AM	124	131	128		120	120	120	
			139	465			149	549
			PHF	0.84			PHF	0.92

	Southbound Off				Northbound Off				Southbound On from West				Southbound On from East			
	Day 1	Day 2	Average	1-Hr	Day 1	Day 2	Average	1-Hr	Day 1	Day 2	Average	1-Hr	Day 1	Day 2	Average	1-Hr
4:00 PM	335	333	334	1330	138	138	556	234	233	234	896	64	64	64	275	
4:15 PM	318	327	323	1326	166	166	551	252	205	229	880	46	46	46	310	
4:30 PM	356	303	330	1310	147	147	493	216	210	213	844	82	82	82	359	
4:45 PM	331	355	343	1340	105	105	426	240	199	220	788	83	83	83	361	
5:00 PM	358	302	330	1308	133	133	412	234	202	218	691	99	99	99	344	
5:15 PM	276	337	307	1241	108	108	350	227	158	193	564	95	95	95	309	
5:30 PM	320	400	360	1165	80	80	307	198	116	157	465	84	84	84	266	
5:45 PM	286	336	311	1010	91	91	282	147	99	123	386	66	66	66	224	
6:00 PM	262	264	263	887	71	71	246	89	93	91	326	64	64	64	199	
6:15 PM	243	219	231		65	65		103	84	94		52	52	52		
6:30 PM	184	225	205		55	55		91	65	78		42	42	42		
6:45 PM	157	218	188		55	55		56	70	63		41	41	41		
			360	1340			166	556			234	896			99	361
			PHF	0.93			PHF	0.84			PHF	0.96			PHF	0.91

	Northbound On from West				Northbound On from East			
	Day 1	Day 2	Average	1-Hr	Day 1	Day 2	Average	1-Hr
4:00 PM	193	195	194	720	219	219	219	606
4:15 PM	197	187	192	694	165	165	165	495
4:30 PM	158	193	176	641	121	121	121	426
4:45 PM	142	173	158	602	101	101	101	385
5:00 PM	170	165	168	545	108	108	108	350
5:15 PM	137	140	139	465	96	96	96	303
5:30 PM	125	149	137	415	80	80	80	252
5:45 PM	100	102	101	359	66	66	66	254
6:00 PM	80	95	88	335	61	61	61	234
6:15 PM	99	79	89		45	45	45	
6:30 PM	72	89	81		82	82	82	
6:45 PM	74	79	77		46	46	46	
			194	720			219	606
			PHF	0.93			PHF	0.69

Location Info	
Location ID	15938
Type	I-SECTION
Functional Class	1
Located On	PACIFIC HIGHWAY NO. 1
	STAFFORD ROAD CONN. NO. 1, SB I-5 off-
Direction	1-WAY
Community	Wilsonville
MPO_ID	
HPMS ID	
Agency	Oregon Traffic Monitoring System

Count Data Info	
Start Date	4/3/2017
End Date	4/4/2017
Start Time	12:15 AM
End Time	12:15 AM
Direction	
Notes	
Count Source	
File Name	OR_Volume_Short_15_2017And2018
Weather	
Study	
Owner	LEGACY
QC Status	Accepted

Interval: 15 mins					
Time	15 Min				Hourly Count
	1st	2nd	3rd	4th	
00:00 - 01:00	16	15	20	15	66
01:00 - 02:00	19	15	10	10	54
02:00 - 03:00	17	6	14	13	50
03:00 - 04:00	20	15	36	36	107
04:00 - 05:00	19	33	65	80	197
05:00 - 06:00	93	127	199	293	712
06:00 - 07:00	226	274	287	366	1153
07:00 - 08:00	304	339	380	392	1415
08:00 - 09:00	336	332	290	309	1267
09:00 - 10:00	299	289	255	227	1070
10:00 - 11:00	213	223	251	230	917
11:00 - 12:00	230	243	261	255	989
12:00 - 13:00	259	289	256	308	1112
13:00 - 14:00	289	271	260	271	1091
14:00 - 15:00	262	273	279	280	1094
15:00 - 16:00	239	249	249	284	1021
16:00 - 17:00	335	318	356	331	1340
17:00 - 18:00	358	276	320	286	1240
18:00 - 19:00	262	243	184	157	846
19:00 - 20:00	155	172	129	122	578
20:00 - 21:00	111	106	80	128	425
21:00 - 22:00	102	98	79	60	339
22:00 - 23:00	48	56	42	42	188
23:00 - 24:00	29	39	25	24	117
TOTAL					17388

Location Info	
Location ID	15938
Type	I-SECTION
Functional Class	1
Located On	PACIFIC HIGHWAY NO. 1
	STAFFORD ROAD CONN. NO. 1, SB I-5 off-
Direction	1-WAY
Community	Wilsonville
MPO_ID	
HPMS ID	
Agency	Oregon Traffic Monitoring System

Count Data Info	
Start Date	4/4/2017
End Date	4/5/2017
Start Time	12:15 AM
End Time	12:15 AM
Direction	
Notes	
Count Source	
File Name	OR_Volume_Short_15_2017And2018
Weather	
Study	
Owner	LEGACY
QC Status	Accepted

Interval: 15 mins					
Time	15 Min				Hourly Count
	1st	2nd	3rd	4th	
00:00 - 01:00	17	16	21	21	75
01:00 - 02:00	17	12	24	13	66
02:00 - 03:00	17	21	10	11	59
03:00 - 04:00	20	19	30	37	106
04:00 - 05:00	31	30	48	106	215
05:00 - 06:00	110	137	193	296	736
06:00 - 07:00	222	257	322	376	1177
07:00 - 08:00	302	381	380	423	1486
08:00 - 09:00	351	353	356	372	1432
09:00 - 10:00	274	271	246	225	1016
10:00 - 11:00	218	198	219	253	888
11:00 - 12:00	239	260	273	293	1065
12:00 - 13:00	265	275	268	265	1073
13:00 - 14:00	295	322	333	300	1250
14:00 - 15:00	275	307	266	235	1083
15:00 - 16:00	259	300	290	324	1173
16:00 - 17:00	333	327	303	355	1318
17:00 - 18:00	302	337	400	336	1375
18:00 - 19:00	264	219	225	218	926
19:00 - 20:00	185	175	129	109	598
20:00 - 21:00	117	113	121	119	470
21:00 - 22:00	120	104	87	68	379
22:00 - 23:00	79	64	58	45	246
23:00 - 24:00	25	34	29	21	109
TOTAL					18321

Location Info	
Location ID	17481
Type	I-SECTION
Functional Class	4
Located On	BEAVERTON-TUALATIN HIGHWAY NO. 141
OFF-R TO	Elligsen Road [on I5 NB]
Direction	1-WAY
Community	Wilsonville
MPO_ID	
HPMS ID	
Agency	Oregon Traffic Monitoring System

Count Data Info	
Start Date	4/3/2017
End Date	4/4/2017
Start Time	1:15 AM
End Time	1:15 AM
Direction	
Notes	
Count Source	
File Name	OR_Volume_Short_15_2017And2018
Weather	
Study	
Owner	LEGACY
QC Status	Accepted

Interval: 15 mins					
Time	15 Min				Hourly Count
	1st	2nd	3rd	4th	
00:00 - 01:00	4	6	5	5	20
01:00 - 02:00	1	26	10	19	56
02:00 - 03:00	14	10	15	27	66
03:00 - 04:00	30	47	105	117	299
04:00 - 05:00	74	102	176	173	525
05:00 - 06:00	142	162	221	204	729
06:00 - 07:00	165	182	212	222	781
07:00 - 08:00	143	126	140	114	523
08:00 - 09:00	109	98	129	107	443
09:00 - 10:00	107	93	105	129	434
10:00 - 11:00	97	120	94	131	442
11:00 - 12:00	101	122	110	120	453
12:00 - 13:00	128	115	99	109	451
13:00 - 14:00	137	144	127	114	522
14:00 - 15:00	111	118	111	124	464
15:00 - 16:00	120	124	138	115	497
16:00 - 17:00	138	166	147	105	556
17:00 - 18:00	133	108	80	91	412
18:00 - 19:00	71	65	55	55	246
19:00 - 20:00	58	48	33	37	176
20:00 - 21:00	52	27	22	28	129
21:00 - 22:00	17	21	23	29	90
22:00 - 23:00	11	16	5	7	39
23:00 - 24:00	5	9	3	4	21
TOTAL					8374

Location Info	
Location ID	17480
Type	I-SECTION
Functional Class	4
Located On	BEAVERTON-TUALATIN HIGHWAY NO. 141
ON-R FROM	SW Boones Ferry Road [on I5 SB]
Direction	1-WAY
Community	Wilsonville
MPO_ID	
HPMS ID	
Agency	Oregon Traffic Monitoring System

Count Data Info	
Start Date	4/4/2017
End Date	4/5/2017
Start Time	12:30 AM
End Time	12:30 AM
Direction	
Notes	
Count Source	
File Name	OR_Volume_Short_15_2017And2018
Weather	
Study	
Owner	LEGACY
QC Status	Accepted

Interval: 15 mins					
Time	15 Min				Hourly Count
	1st	2nd	3rd	4th	
00:00 - 01:00	18	20	5	9	52
01:00 - 02:00	9	6	3	2	20
02:00 - 03:00	7	11	10	10	38
03:00 - 04:00	3	3	8	1	15
04:00 - 05:00	9	12	7	14	42
05:00 - 06:00	8	9	25	29	71
06:00 - 07:00	31	49	54	78	212
07:00 - 08:00	86	89	98	100	373
08:00 - 09:00	66	81	81	67	295
09:00 - 10:00	54	55	49	58	216
10:00 - 11:00	61	37	57	62	217
11:00 - 12:00	44	51	49	61	205
12:00 - 13:00	73	91	85	63	312
13:00 - 14:00	52	72	70	75	269
14:00 - 15:00	108	136	103	143	490
15:00 - 16:00	137	189	187	253	766
16:00 - 17:00	234	252	216	240	942
17:00 - 18:00	234	227	198	147	806
18:00 - 19:00	89	103	91	56	339
19:00 - 20:00	62	33	49	19	163
20:00 - 21:00	42	36	35	31	144
21:00 - 22:00	31	30	28	33	122
22:00 - 23:00	22	14	19	11	66
23:00 - 24:00	14	10	19	4	47
TOTAL					6222

Location Info	
Location ID	17480
Type	I-SECTION
Functional Class	4
Located On	BEAVERTON-TUALATIN HIGHWAY NO. 141
ON-R FROM	SW Boones Ferry Road [on I5 SB]
Direction	1-WAY
Community	Wilsonville
MPO_ID	
HPMS ID	
Agency	Oregon Traffic Monitoring System

Count Data Info	
Start Date	4/12/2021
End Date	4/13/2021
Start Time	12:00 PM
End Time	12:00 PM
Direction	
Notes	ordot
Count Source	174800000
File Name	17480_V.PRN
Weather	
Study	
Owner	claycarney
QC Status	Accepted

Interval: 15 mins					
Time	15 Min				Hourly Count
	1st	2nd	3rd	4th	
00:00 - 01:00	16	12	10	6	44
01:00 - 02:00	19	9	11	6	45
02:00 - 03:00	13	15	22	4	54
03:00 - 04:00	10	9	4	2	25
04:00 - 05:00	12	14	18	24	68
05:00 - 06:00	24	24	50	47	145
06:00 - 07:00	46	66	62	66	240
07:00 - 08:00	87	90	64	94	335
08:00 - 09:00	80	73	77	74	304
09:00 - 10:00	60	66	82	54	262
10:00 - 11:00	78	66	87	70	301
11:00 - 12:00	68	90	70	97	325
12:00 - 13:00	72	78	97	87	334
13:00 - 14:00	86	74	86	116	362
14:00 - 15:00	94	100	163	146	503
15:00 - 16:00	178	156	258	231	823
16:00 - 17:00	233	205	210	199	847
17:00 - 18:00	202	158	116	99	575
18:00 - 19:00	93	84	65	70	312
19:00 - 20:00	48	44	38	46	176
20:00 - 21:00	40	22	26	33	121
21:00 - 22:00	30	22	21	27	100
22:00 - 23:00	16	19	22	20	77
23:00 - 24:00	18	15	13	5	51
TOTAL					6429

Location Info	
Location ID	17486
Type	I-SECTION
Functional Class	4
Located On	BEAVERTON-TUALATIN HIGHWAY NO. 141
NORTH OF	SW Elligsen Road (OR141) [PACIFIC HIGHWAY-
Direction	1-WAY
Community	Wilsonville
MPO_ID	
HPMS ID	
Agency	Oregon Traffic Monitoring System

Count Data Info	
Start Date	4/3/2017
End Date	4/4/2017
Start Time	12:15 AM
End Time	12:15 AM
Direction	
Notes	
Count Source	
File Name	OR_Volume_Short_15_2017And2018
Weather	
Study	
Owner	LEGACY
QC Status	Accepted

Interval: 15 mins					
Time	15 Min				Hourly Count
	1st	2nd	3rd	4th	
00:00 - 01:00	0	9	4	2	15
01:00 - 02:00	5	0	0	1	6
02:00 - 03:00	1	0	5	7	13
03:00 - 04:00	4	0	7	4	15
04:00 - 05:00	6	8	3	9	26
05:00 - 06:00	10	8	7	8	33
06:00 - 07:00	13	27	29	20	89
07:00 - 08:00	35	31	38	28	132
08:00 - 09:00	35	24	40	25	124
09:00 - 10:00	35	22	40	26	123
10:00 - 11:00	28	39	42	50	159
11:00 - 12:00	47	57	63	58	225
12:00 - 13:00	57	54	77	58	246
13:00 - 14:00	73	63	58	54	248
14:00 - 15:00	66	62	80	63	271
15:00 - 16:00	80	60	76	91	307
16:00 - 17:00	64	46	82	83	275
17:00 - 18:00	99	95	84	66	344
18:00 - 19:00	64	52	42	41	199
19:00 - 20:00	43	38	30	29	140
20:00 - 21:00	40	25	35	20	120
21:00 - 22:00	17	11	13	13	54
22:00 - 23:00	16	8	13	17	54
23:00 - 24:00	4	7	15	4	30
TOTAL					3248

Location Info	
Location ID	17486
Type	I-SECTION
Functional Class	4
Located On	BEAVERTON-TUALATIN HIGHWAY NO. 141
NORTH OF	SW Elligsen Road (OR141) [PACIFIC HIGHWAY-
Direction	1-WAY
Community	Wilsonville
MPO_ID	
HPMS ID	
Agency	Oregon Traffic Monitoring System

Count Data Info	
Start Date	4/4/2017
End Date	4/5/2017
Start Time	12:15 AM
End Time	12:15 AM
Direction	
Notes	
Count Source	
File Name	OR_Volume_Short_15_2017And2018
Weather	
Study	
Owner	LEGACY
QC Status	Accepted

Interval: 15 mins					
Time	15 Min				Hourly Count
	1st	2nd	3rd	4th	
00:00 - 01:00	4	8	10	11	33
01:00 - 02:00	0	0	3	1	4
02:00 - 03:00	1	1	1	1	4
03:00 - 04:00	2	7	1	4	14
04:00 - 05:00	8	6	5	9	28
05:00 - 06:00	3	7	4	6	20
06:00 - 07:00	17	18	19	28	82
07:00 - 08:00	31	39	31	47	148
08:00 - 09:00	29	34	48	39	150
09:00 - 10:00	41	32	21	22	116
10:00 - 11:00	19	46	42	42	149
11:00 - 12:00	41	55	60	52	208
12:00 - 13:00	64	70	71	55	260
13:00 - 14:00	66	55	60	60	241
14:00 - 15:00	69	80	95	73	317
15:00 - 16:00	74	56	78	76	284
16:00 - 17:00	77	59	97	83	316
17:00 - 18:00	98	103	77	69	347
18:00 - 19:00	59	46	51	33	189
19:00 - 20:00	39	48	43	27	157
20:00 - 21:00	34	32	30	20	116
21:00 - 22:00	18	15	18	13	64
22:00 - 23:00	11	9	9	17	46
23:00 - 24:00	10	5	18	16	49
TOTAL					3342

Location Info	
Location ID	17483
Type	I-SECTION
Functional Class	4
Located On	BEAVERTON-TUALATIN HIGHWAY NO. 141
	PACIFIC HIGHWAY-ELIGSEN ROAD CONN.,
Direction	1-WAY
Community	Wilsonville
MPO_ID	
HPMS ID	
Agency	Oregon Traffic Monitoring System

Count Data Info	
Start Date	4/3/2017
End Date	4/4/2017
Start Time	1:45 AM
End Time	1:45 AM
Direction	
Notes	
Count Source	
File Name	OR_Volume_Short_15_2017And2018
Weather	
Study	
Owner	LEGACY
QC Status	Accepted

Interval: 15 mins					
Time	15 Min				Hourly Count
	1st	2nd	3rd	4th	
00:00 - 01:00	7	4	10	3	24
01:00 - 02:00	2	7	5	8	22
02:00 - 03:00	10	5	8	14	37
03:00 - 04:00	27	22	24	19	92
04:00 - 05:00	36	36	29	61	162
05:00 - 06:00	54	78	88	79	299
06:00 - 07:00	74	70	87	97	328
07:00 - 08:00	82	89	73	81	325
08:00 - 09:00	79	86	116	80	361
09:00 - 10:00	97	92	130	124	443
10:00 - 11:00	137	143	134	141	555
11:00 - 12:00	119	120	117	132	488
12:00 - 13:00	143	135	125	151	554
13:00 - 14:00	148	130	165	122	565
14:00 - 15:00	125	140	176	152	593
15:00 - 16:00	163	140	155	161	619
16:00 - 17:00	193	197	158	142	690
17:00 - 18:00	170	137	125	100	532
18:00 - 19:00	80	99	72	74	325
19:00 - 20:00	86	78	47	109	320
20:00 - 21:00	57	35	24	16	132
21:00 - 22:00	27	16	31	15	89
22:00 - 23:00	14	5	14	15	48
23:00 - 24:00	9	2	8	1	20
TOTAL					7623

Location Info	
Location ID	17483
Type	I-SECTION
Functional Class	4
Located On	BEAVERTON-TUALATIN HIGHWAY NO. 141
	PACIFIC HIGHWAY-ELIGSEN ROAD CONN.,
Direction	1-WAY
Community	Wilsonville
MPO_ID	
HPMS ID	
Agency	Oregon Traffic Monitoring System

Count Data Info	
Start Date	4/4/2017
End Date	4/5/2017
Start Time	1:45 AM
End Time	1:45 AM
Direction	
Notes	
Count Source	
File Name	OR_Volume_Short_15_2017And2018
Weather	
Study	
Owner	LEGACY
QC Status	Accepted

Interval: 15 mins					
Time	15 Min				Hourly Count
	1st	2nd	3rd	4th	
00:00 - 01:00	5	4	10	8	27
01:00 - 02:00	11	7	13	10	41
02:00 - 03:00	9	15	19	12	55
03:00 - 04:00	28	16	17	16	77
04:00 - 05:00	19	40	36	61	156
05:00 - 06:00	74	93	93	88	348
06:00 - 07:00	87	102	82	75	346
07:00 - 08:00	73	82	63	96	314
08:00 - 09:00	81	100	101	101	383
09:00 - 10:00	102	103	148	131	484
10:00 - 11:00	106	122	136	130	494
11:00 - 12:00	133	162	141	121	557
12:00 - 13:00	152	115	132	127	526
13:00 - 14:00	141	131	154	142	568
14:00 - 15:00	140	143	173	125	581
15:00 - 16:00	174	148	163	164	649
16:00 - 17:00	195	187	193	173	748
17:00 - 18:00	165	140	149	102	556
18:00 - 19:00	95	79	89	79	342
19:00 - 20:00	66	80	67	57	270
20:00 - 21:00	42	29	31	23	125
21:00 - 22:00	33	20	25	16	94
22:00 - 23:00	13	18	13	9	53
23:00 - 24:00	12	9	8	1	30
TOTAL					7824

Location Info	
Location ID	###
Type	1-
Functional Class	1
Located On	BEA
SOUTH OF	SW
Direction	1-
Community	Wils
MPO_ID	
HPMS ID	
Agency	Ore

Count Data	
Start Date	4/3/2017
End Date	4/4/2017
Start Time	1:45 AM
End Time	1:45 AM
Direction	
Notes	
Count Source	
File Name	OR_Volume_Short_15_2017And2018
Weather	
Study	
Owner	LEGACY
QC Status	Accepted

Interval. 15 mins					
Time	15				Hourly Count
	1st	2nd	3rd	4th	
00:00 - 01:00	10	10	7	17	44
01:00 - 02:00	19	9	7	10	45
02:00 - 03:00	6	21	14	16	57
03:00 - 04:00	17	29	16	25	87
04:00 - 05:00	33	38	51	74	196
05:00 - 06:00	76	102	130	124	432
06:00 - 07:00	124	161	167	146	598
07:00 - 08:00	149	128	137	135	549
08:00 - 09:00	131	117	115	124	487
09:00 - 10:00	110	135	127	120	492
10:00 - 11:00	110	137	118	132	497
11:00 - 12:00	120	129	103	100	452
12:00 - 13:00	124	122	97	136	479
13:00 - 14:00	159	125	205	145	634
14:00 - 15:00	181	140	201	122	644
15:00 - 16:00	197	146	209	135	687
16:00 - 17:00	219	165	121	101	606
17:00 - 18:00	108	96	80	66	350
18:00 - 19:00	61	45	82	46	234
19:00 - 20:00	53	32	52	59	196
20:00 - 21:00	74	32	30	37	173
21:00 - 22:00	32	24	19	13	88
22:00 - 23:00	15	8	28	17	68
23:00 - 24:00	13	4	11	9	37
TOTAL					8132

Location Info	
Location ID	###
Type	1-
Functional Class	1
Located On	BEA
SOUTH OF	SW
Direction	1-
Community	Wils
MPO_ID	
HPMS ID	
Agency	Ore

Count Data	
Start Date	4/4/2017
End Date	4/5/2017
Start Time	1:45 AM
End Time	1:45 AM
Direction	
Notes	
Count Source	
File Name	OR_Volume_Short_15_2017And2018
Weather	
Study	
Owner	LEGACY
QC Status	Accepted

Interval. 15 mins					
Time	15				Hourly Count
	1st	2nd	3rd	4th	
00:00 - 01:00	8	16	10	5	39
01:00 - 02:00	13	16	12	7	48
02:00 - 03:00	9	11	9	11	40
03:00 - 04:00	30	25	26	33	114
04:00 - 05:00	29	42	57	85	213
05:00 - 06:00	85	127	138	131	481
06:00 - 07:00	150	150	165	151	616
07:00 - 08:00	152	130	139	135	556
08:00 - 09:00	147	126	134	132	539
09:00 - 10:00	132	127	122	127	508
10:00 - 11:00	124	133	141	141	539
11:00 - 12:00	178	120	118	106	522
12:00 - 13:00	132	111	130	155	528
13:00 - 14:00	137	145	164	179	625
14:00 - 15:00	184	150	190	138	662
15:00 - 16:00	189	149	230	166	734
16:00 - 17:00	197	179	128	133	637
17:00 - 18:00	132	113	82	72	399
18:00 - 19:00	59	53	75	55	242
19:00 - 20:00	39	36	32	34	141
20:00 - 21:00	73	33	31	26	163
21:00 - 22:00	30	24	30	11	95
22:00 - 23:00	28	12	22	24	86
23:00 - 24:00	12	14	10	15	51
TOTAL					8578

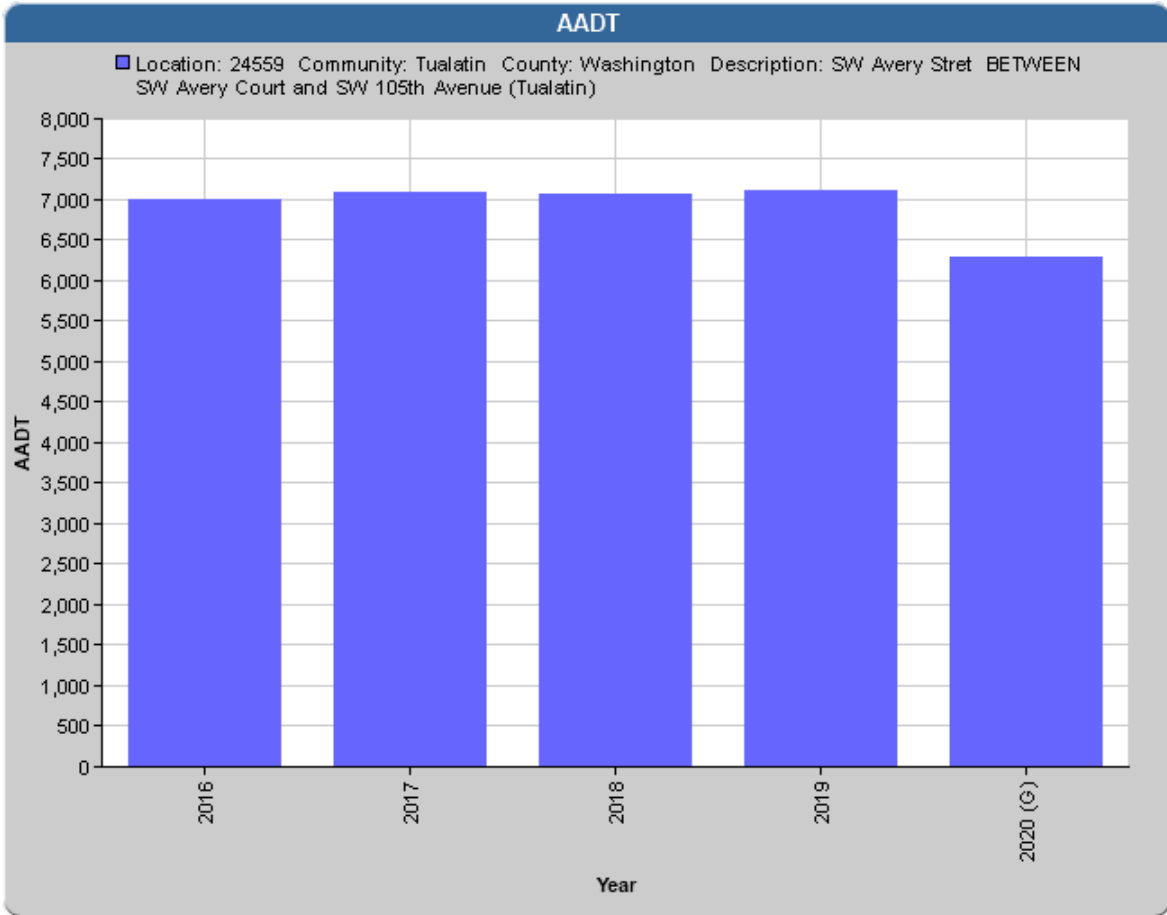

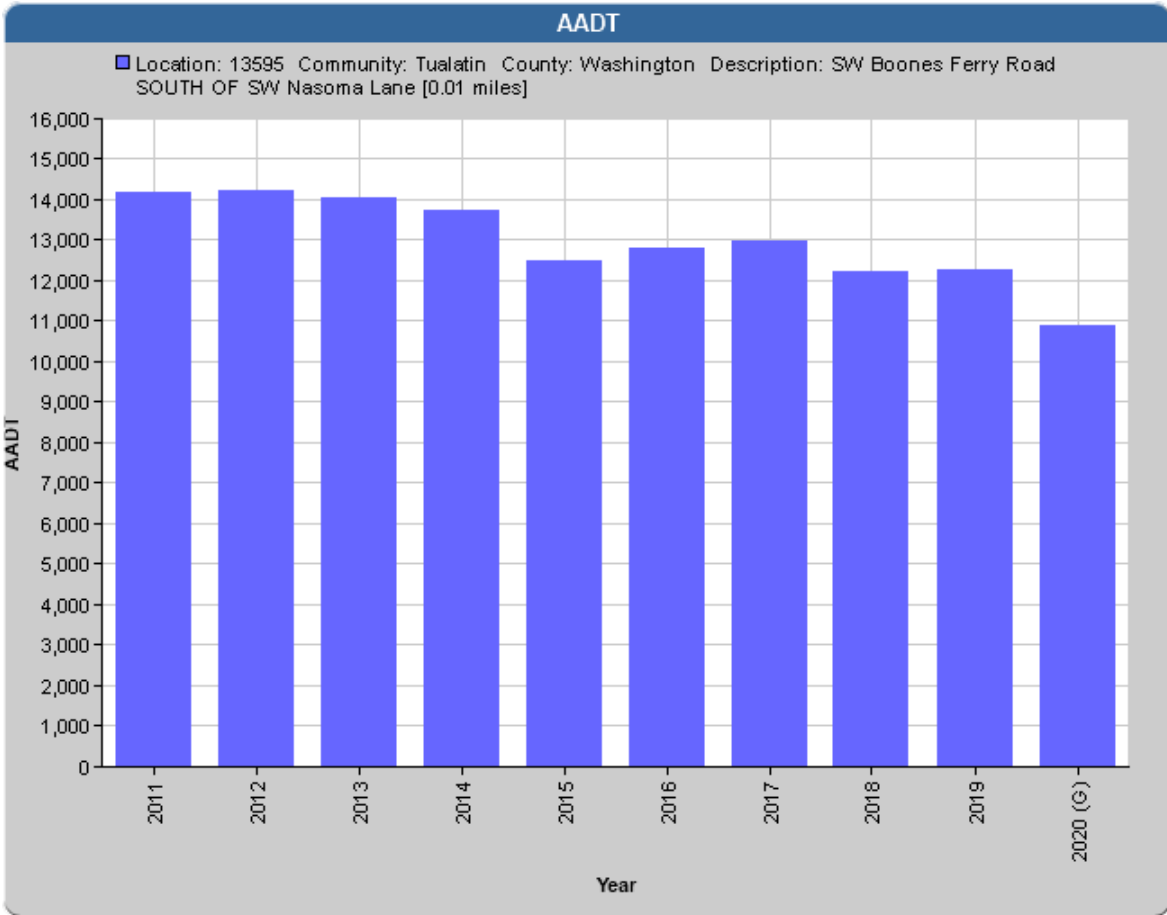

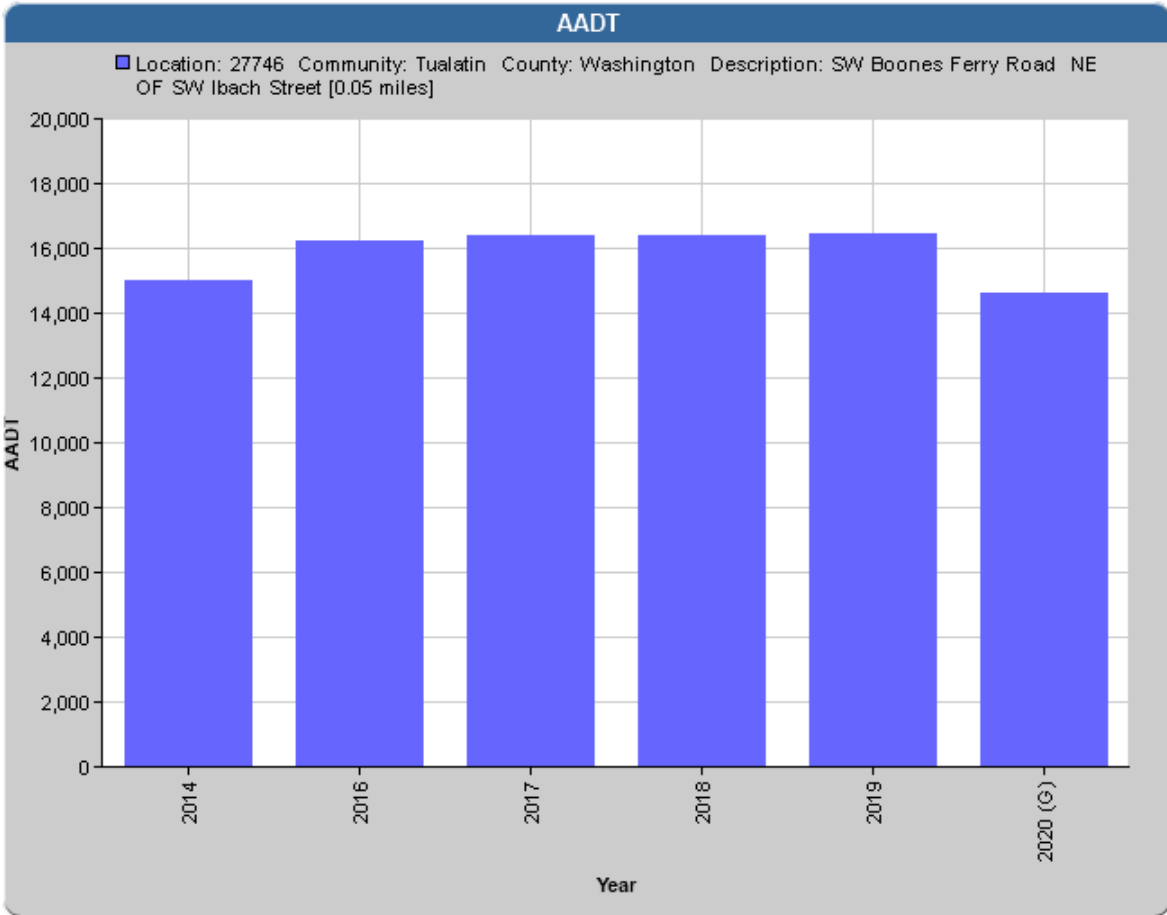

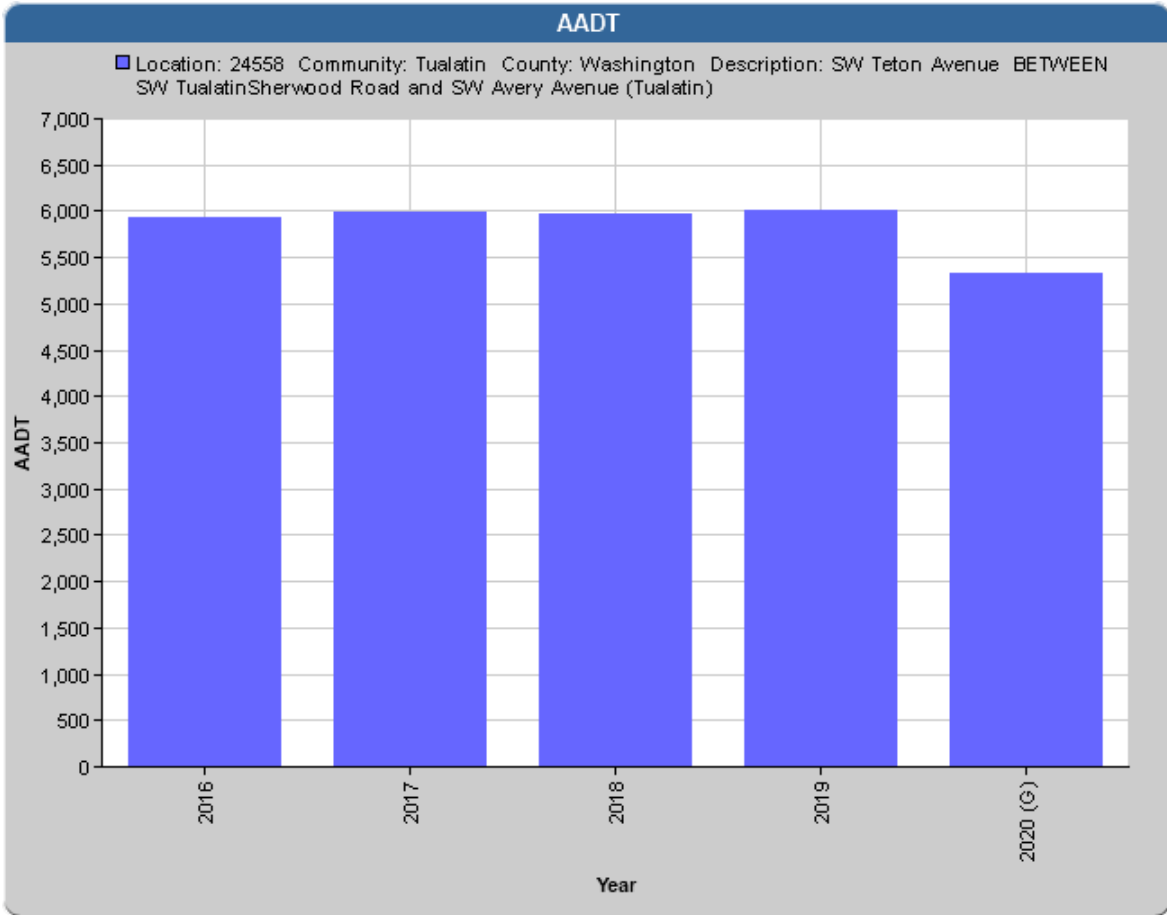

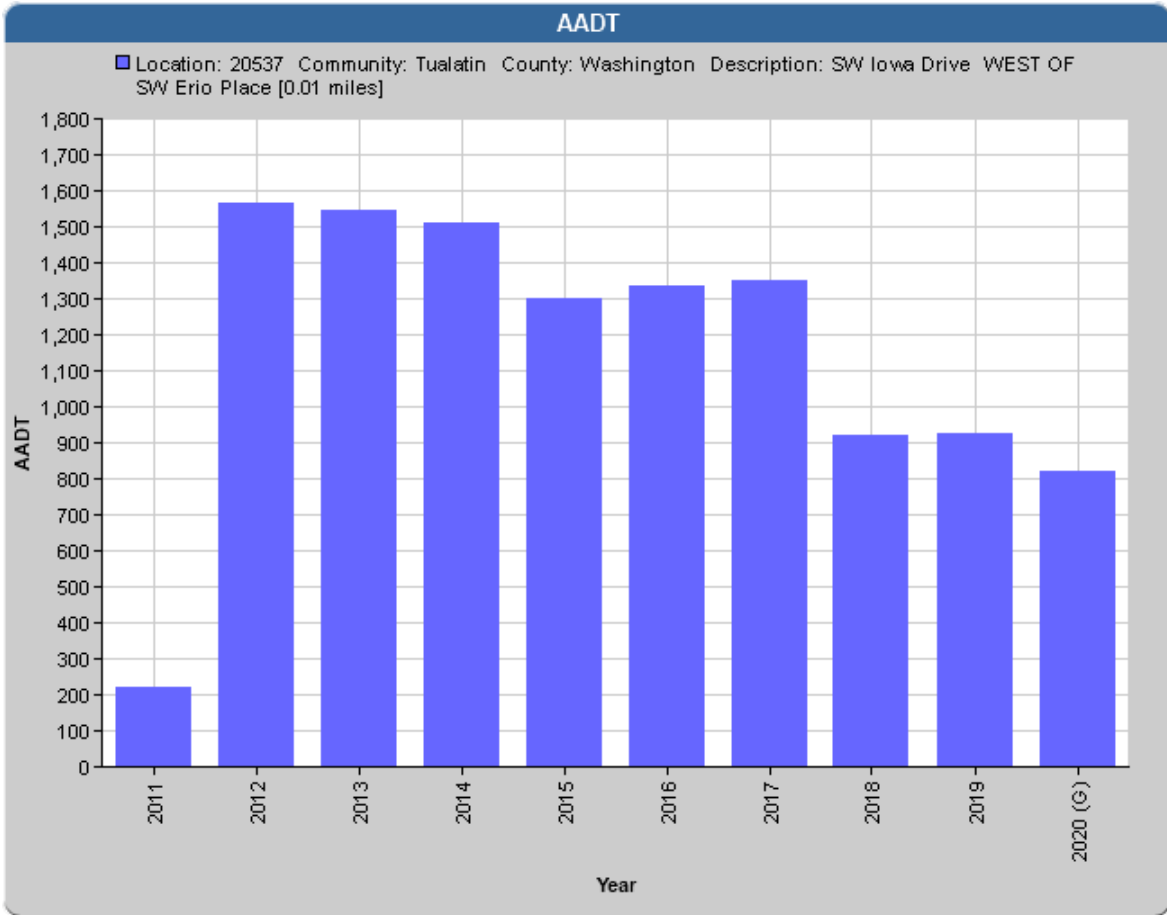

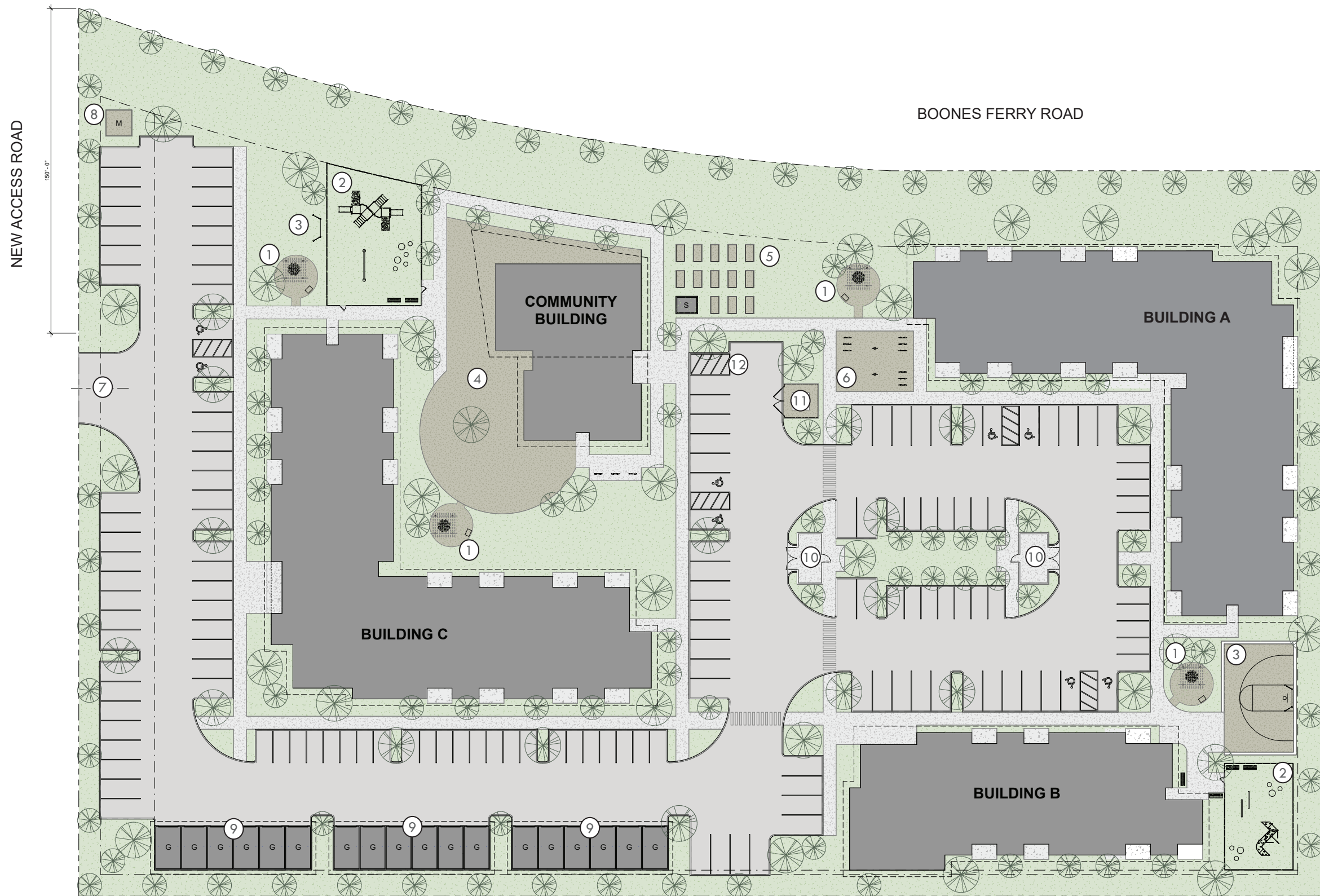

- KEYNOTES/ LEGEND**
- ① PICNIC/ GRILLING AREA
 - ② PLAY STRUCTURE
 - ③ OUTDOOR SPORT AREA
 - ④ PLAZA AREA
 - ⑤ COMMUNITY GARDEN
 - ⑥ BIKE PARKING & REPAIR STATION
 - ⑦ SITE ACCESS
 - ⑧ MONUMENT SIGN
 - ⑨ GARAGES/ CAR PORTS
 - ⑩ TRASH ENCLOSURE
 - ⑪ TRANSFORMER & SCREENING
 - ⑫ LOADING ZONE



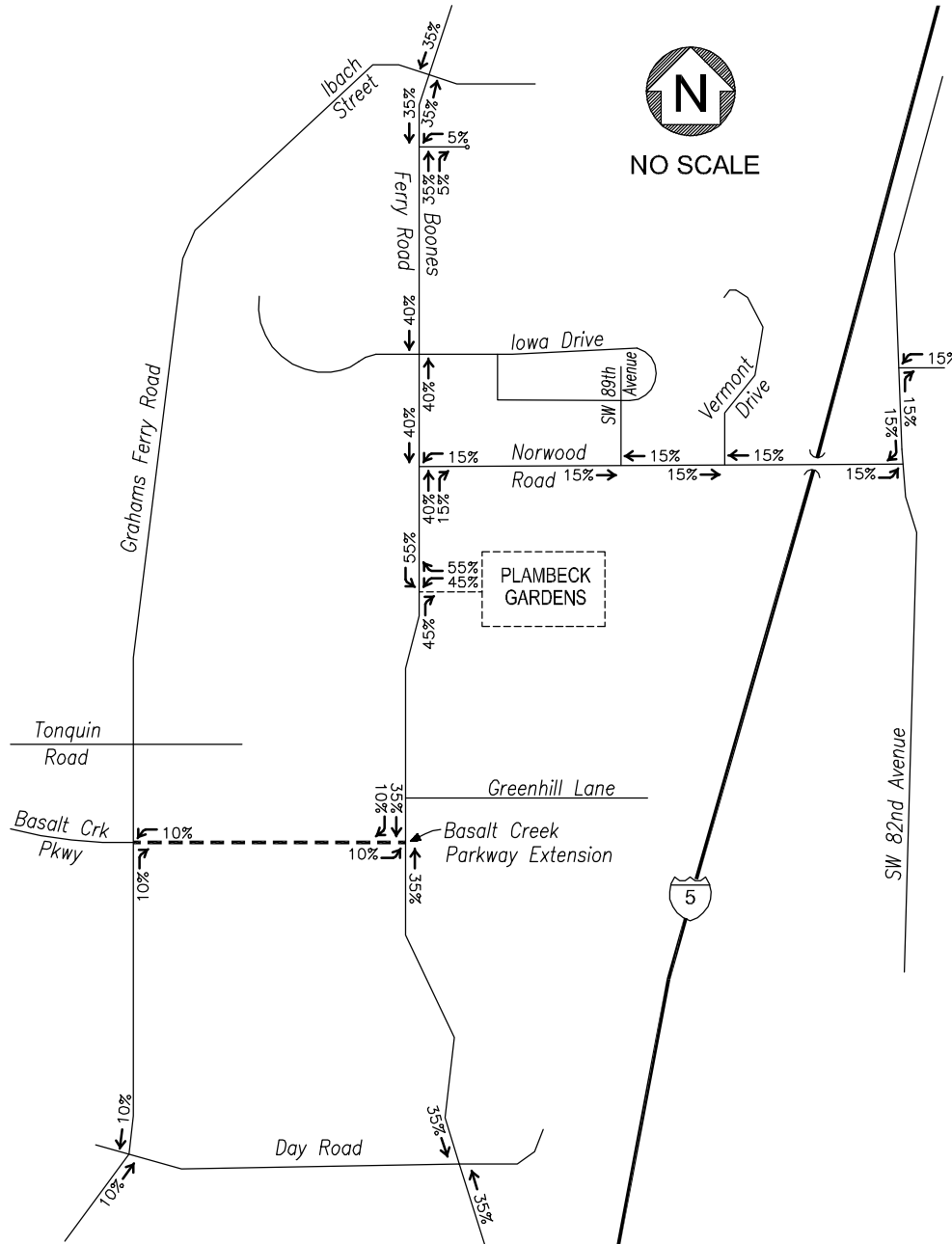

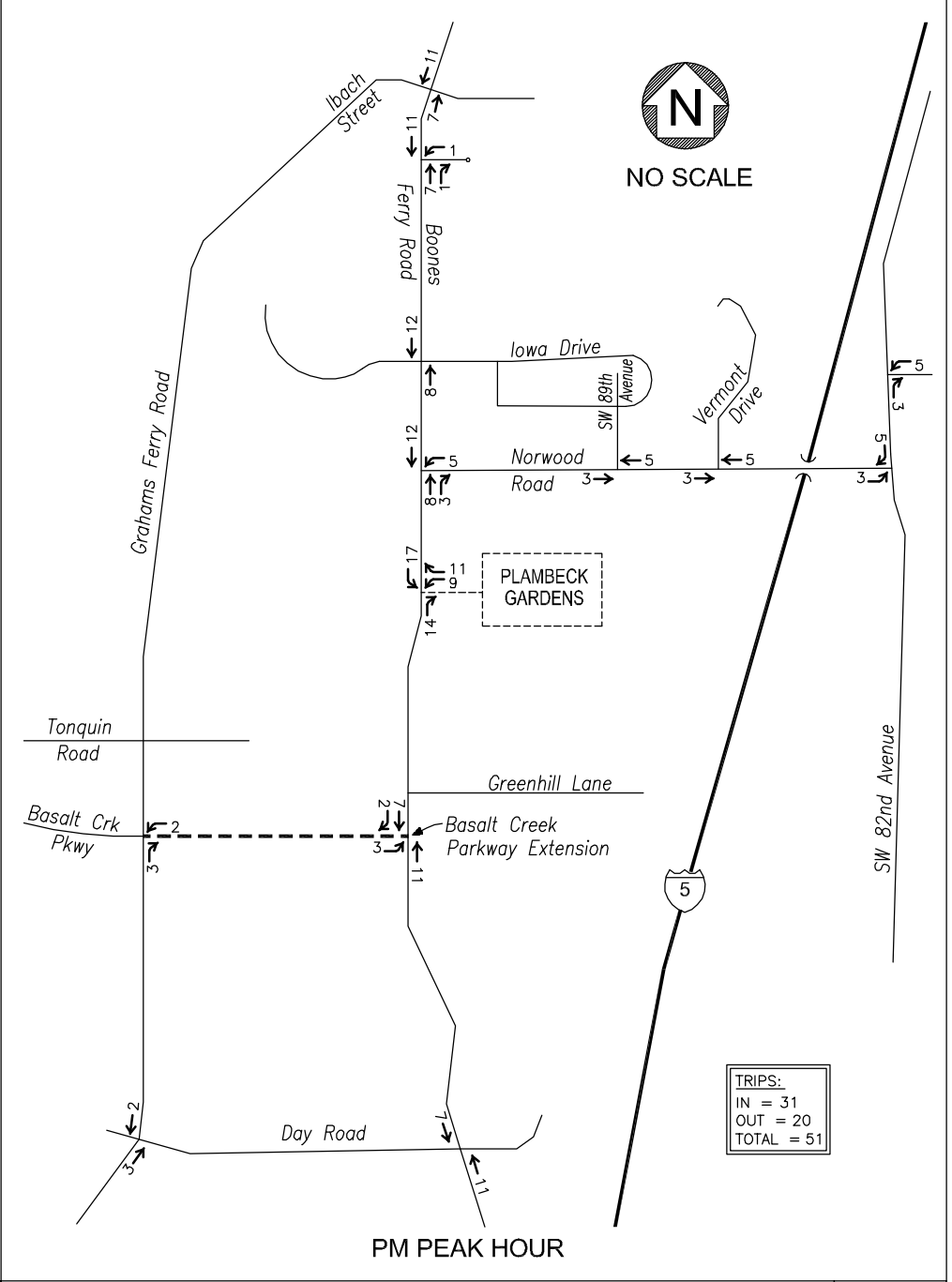
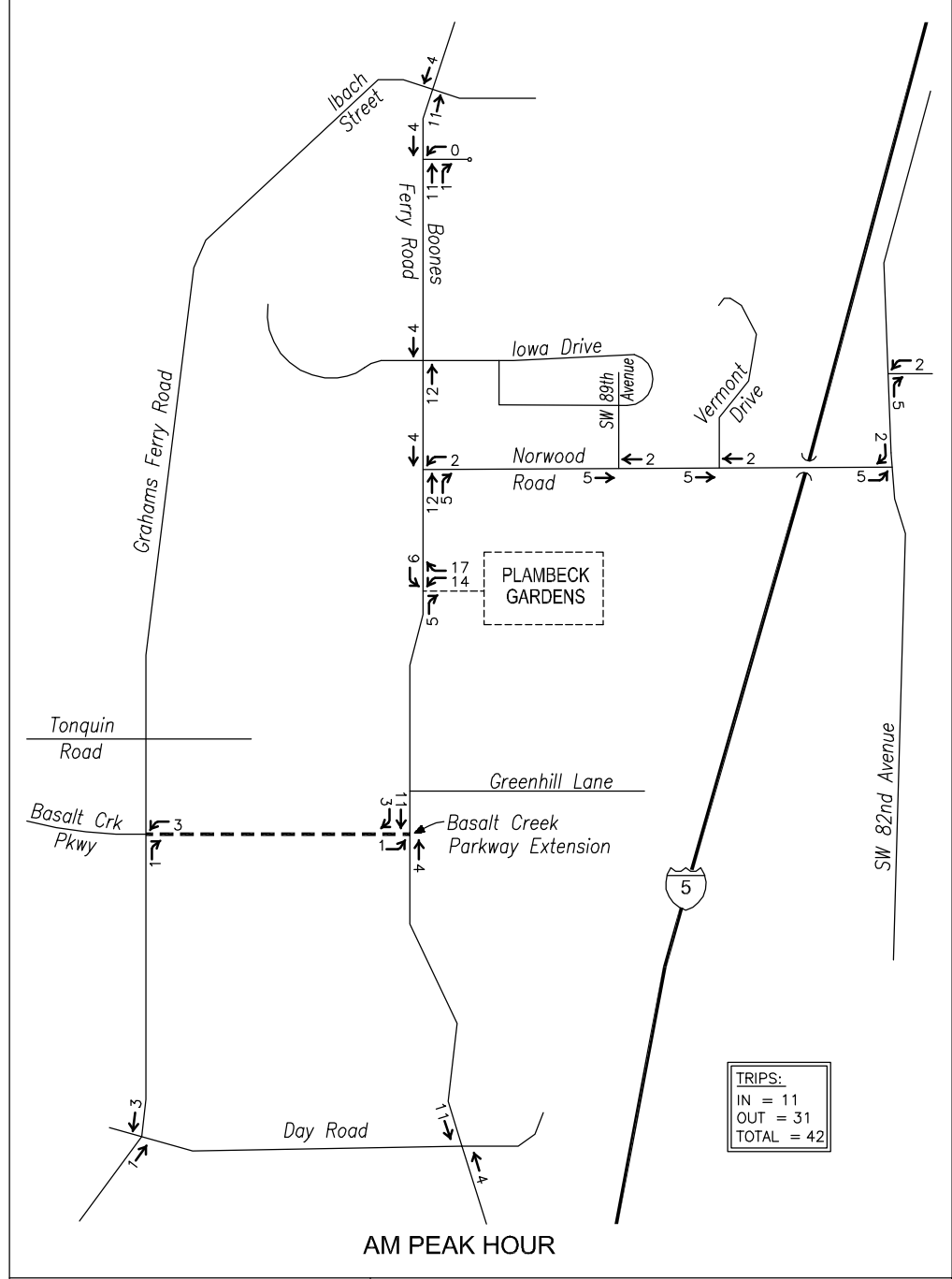

Appendix C – Safety

Crash Data

Sight Distance

Warrants (Left-Turn, Right-Turn, Preliminary Signal)



1. BFR & Sagert

INVSTG_AGY			LANE RDWY										CRASH_HR_				HWY_COMPN								
CRASH_ID	INT_ID	SER_NO	SHORT_DES	CRASH_SPEE	ALCHL_IN	DRUG_INV	MJ_INVLV	SCHL_ZON	WRK_ZON	DPRT	CRASH	UNLOCT	CRASH_DT	CRASH_WK	SHORT_DES	URB_AREA_SHORT_	HWY_NO	HWY_MED_NM	RDWY_NO	FC_CD	HWY_COM T_SHORT_DE	MLGE_TY	RD_CON_	LRS VAL	
				D_INVLV_FLG	VLV_FLG	LV_FLG	FLG	E_IND	E_IND	FLG	FLG														
1639709	1	05417	CITY	0	0	0	0	0	0	N	FALSE	9/18/2015	6	5P	Washington	Tualatin	PORTLAND UA			16					
1639709	1	05417	CITY	0	0	0	0	0	0	N	FALSE	9/18/2015	6	5P	Washington	Tualatin	PORTLAND UA			16					
1662714	1	02177	CITY	0	0	0	0	0	0	N	FALSE	4/3/2016	1	6P	Washington	Tualatin	PORTLAND UA			16					
1662714	1	02177	CITY	0	0	0	0	0	0	N	FALSE	4/3/2016	1	6P	Washington	Tualatin	PORTLAND UA			16					
1662714	1	02177	CITY	0	0	0	0	0	0	N	FALSE	4/3/2016	1	6P	Washington	Tualatin	PORTLAND UA			16					
1674189	1	06080	NONE	0	0	0	0	0	0	N	FALSE	9/10/2016	7	2P	Washington	Tualatin	PORTLAND UA			16					
1674189	1	06080	NONE	0	0	0	0	0	0	N	FALSE	9/10/2016	7	2P	Washington	Tualatin	PORTLAND UA			16					
1674189	1	06080	NONE	0	0	0	0	0	0	N	FALSE	9/10/2016	7	2P	Washington	Tualatin	PORTLAND UA			16					
1674189	1	06080	NONE	0	0	0	0	0	0	N	FALSE	9/10/2016	7	2P	Washington	Tualatin	PORTLAND UA			16					
1632552	1	01458	NONE	0	0	0	0	0	0	N	FALSE	3/18/2015	4	3P	Washington	Tualatin	PORTLAND UA			16					
1632552	1	01458	NONE	0	0	0	0	0	0	N	FALSE	3/18/2015	4	3P	Washington	Tualatin	PORTLAND UA			16					
1632552	1	01458	NONE	0	0	0	0	0	0	N	FALSE	3/18/2015	4	3P	Washington	Tualatin	PORTLAND UA			16					
1682601	1	02161	CITY	0	0	0	0	0	0	N	FALSE	4/2/2016	7	12P	Washington	Tualatin	PORTLAND UA			16					
1682601	1	02161	CITY	0	0	0	0	0	0	N	FALSE	4/2/2016	7	12P	Washington	Tualatin	PORTLAND UA			16					
1682601	1	02161	CITY	0	0	0	0	0	0	N	FALSE	4/2/2016	7	12P	Washington	Tualatin	PORTLAND UA			16					
1747939	1	85470	NONE	0	0	0	0	0	0	N	FALSE	12/21/2017	5	5P	Washington	Tualatin	PORTLAND UA			16					
1747939	1	85470	NONE	0	0	0	0	0	0	N	FALSE	12/21/2017	5	5P	Washington	Tualatin	PORTLAND UA			16					
1859676	1	04055	NONE	0	0	0	0	0	0	N	FALSE	8/9/2019	6	4P	Washington	Tualatin	PORTLAND UA			16					
1859676	1	04055	NONE	0	0	0	0	0	0	N	FALSE	8/9/2019	6	4P	Washington	Tualatin	PORTLAND UA			16					
1612413	1	04396	CITY	0	0	0	0	0	0	N	FALSE	7/2/2015	5	4P	Washington	Tualatin	PORTLAND UA			16					
1612413	1	04396	CITY	0	0	0	0	0	0	N	FALSE	7/2/2015	5	4P	Washington	Tualatin	PORTLAND UA			16					
1728893	1	01979	CITY	0	0	0	0	0	0	N	FALSE	4/9/2017	1	2P	Washington	Tualatin	PORTLAND UA			16					
1728893	1	01979	CITY	0	0	0	0	0	0	N	FALSE	4/9/2017	1	2P	Washington	Tualatin	PORTLAND UA			16					
1728893	1	01979	CITY	0	0	0	0	0	0	N	FALSE	4/9/2017	1	2P	Washington	Tualatin	PORTLAND UA			16					
1728893	1	01979	CITY	0	0	0	0	0	0	N	FALSE	4/9/2017	1	2P	Washington	Tualatin	PORTLAND UA			16					
1728893	1	01979	CITY	0	0	0	0	0	0	N	FALSE	4/9/2017	1	2P	Washington	Tualatin	PORTLAND UA			16					
1738697	1	08232	CITY	0	1	0	0	0	0	N	FALSE	12/22/2017	6	3P	Washington	Tualatin	PORTLAND UA			16					
1738697	1	08232	CITY	0	1	0	0	0	0	N	FALSE	12/22/2017	6	3P	Washington	Tualatin	PORTLAND UA			16					
1738697	1	08232	CITY	0	1	0	0	0	0	N	FALSE	12/22/2017	6	3P	Washington	Tualatin	PORTLAND UA			16					
1738697	1	08232	CITY	0	1	0	0	0	0	N	FALSE	12/22/2017	6	3P	Washington	Tualatin	PORTLAND UA			16					
1861457	1	04949	CITY	0	0	0	0	0	0	N	FALSE	9/26/2019	5	3P	Washington	Tualatin	PORTLAND UA			16					
1861457	1	04949	CITY	0	0	0	0	0	0	N	FALSE	9/26/2019	5	3P	Washington	Tualatin	PORTLAND UA			16					
1822696	1	04824	NONE	0	0	0	0	0	0	N	FALSE	9/13/2018	5	6P	Washington	Tualatin	PORTLAND UA			16					
1822696	1	04824	NONE	0	0	0	0	0	0	N	FALSE	9/13/2018	5	6P	Washington	Tualatin	PORTLAND UA			16					
1695979	1	04901	CITY	0	0	0	0	0	0	N	FALSE	7/25/2016	2	1P	Washington	Tualatin	PORTLAND UA			16					
1695979	1	04901	CITY	0	0	0	0	0	0	N	FALSE	7/25/2016	2	1P	Washington	Tualatin	PORTLAND UA			16					
1662082	1	01878	CITY	0	0	0	0	0	0	N	FALSE	3/21/2016	2	4P	Washington	Tualatin	PORTLAND UA			16					
1662082	1	01878	CITY	0	0	0	0	0	0	N	FALSE	3/21/2016	2	4P	Washington	Tualatin	PORTLAND UA			16					
1793986	1	02871	CITY	0	0	0	0	0	0	N	FALSE	6/5/2018	3	1P	Washington	Tualatin	PORTLAND UA			16					
1793986	1	02871	CITY	0	0	0	0	0	0	N	FALSE	6/5/2018	3	1P	Washington	Tualatin	PORTLAND UA			16					
1820976	1	04209	CITY	0	0	0	0	0	0	N	FALSE	8/7/2018	3	11A	Washington	Tualatin	PORTLAND UA			16					
1820976	1	04209	CITY	0	0	0	0	0	0	N	FALSE	8/7/2018	3	11A	Washington	Tualatin	PORTLAND UA			16					
1823721	1	06922	NONE	0	0	0	0	0	0	N	FALSE	12/16/2018	1	4P	Washington	Tualatin	PORTLAND UA			16					
1823721	1	06922	NONE	0	0	0	0	0	0	N	FALSE	12/16/2018	1	4P	Washington	Tualatin	PORTLAND UA			16					
1839949	1	01467	CITY	0	0	0	0	0	0	N	FALSE	3/23/2019	7	10A	Washington	Tualatin	PORTLAND UA			16					
1839949	1	01467	CITY	0	0	0	0	0	0	N	FALSE	3/23/2019	7	10A	Washington	Tualatin	PORTLAND UA			16					

1. BFR & Sagert

MP_NO	ST_NO	ST_NM	ISECT_ST_		RD_CHAR_CD	RD_CHAR_S	CMPSS_DI	CMPSS_DIR			IMPCT_L	MEDN_TYP_			TRAF_CNTL_DE				WTHR_CON			LGT_COND_		COLLIS_TYP_		CRASH_SVR
			NO	ISECT_ST_NM				R_CD	HORT_DESC	R_CD		FROM_CD	SC	OC_CD	HORT_DESC	C	G_QTY	LN_QTY	ISECT_REL_FLG	VICE_SHORT_DE	OFF_RDW	RNDABT_F	DRVVWY_R	D_SHORT_D	RD_SURF_S	SHORT_DES
00201	00201	SW BOONES FERRY RD	02201	SW SAGERT ST	1	INTER	1		N	06	CROSS		0			0	TRF SIGNAL	0	0	0	CLR	DRY	DAY	S-1STOP	REAR	PDO
00201	00201	SW BOONES FERRY RD	02201	SW SAGERT ST	1	INTER	1		N	06	CROSS		0			0	TRF SIGNAL	0	0	0	CLR	DRY	DAY	S-1STOP	REAR	PDO
00201	00201	SW BOONES FERRY RD	02201	SW SAGERT ST	3	STRGHT	1		N	06		NONE	2	1	UNKNOWN	0	0	0	0	CLR	DRY	DUSK	S-1STOP	REAR	INJ	
00201	00201	SW BOONES FERRY RD	02201	SW SAGERT ST	3	STRGHT	1		N	06		NONE	2	1	UNKNOWN	0	0	0	0	CLR	DRY	DUSK	S-1STOP	REAR	INJ	
00201	00201	SW BOONES FERRY RD	02201	SW SAGERT ST	3	STRGHT	1		N	06		NONE	2	1	UNKNOWN	0	0	0	0	CLR	DRY	DAY	S-1STOP	REAR	INJ	
00201	00201	SW BOONES FERRY RD	02201	SW SAGERT ST	3	STRGHT	1		N	06		NONE	2	1	UNKNOWN	0	0	0	0	CLR	DRY	DAY	S-1STOP	REAR	INJ	
00201	00201	SW BOONES FERRY RD	02201	SW SAGERT ST	3	STRGHT	1		N	06		NONE	2	1	UNKNOWN	0	0	0	0	CLR	DRY	DAY	S-1STOP	REAR	INJ	
00201	00201	SW BOONES FERRY RD	02201	SW SAGERT ST	3	STRGHT	1		N	06		NONE	2	1	UNKNOWN	0	0	0	0	CLR	DRY	DAY	S-1STOP	REAR	INJ	
00201	00201	SW BOONES FERRY RD	02201	SW SAGERT ST	3	STRGHT	1		N	07		NONE	2	0	UNKNOWN	0	0	0	0	CLR	DRY	DAY	S-STRGHT	REAR	PDO	
00201	00201	SW BOONES FERRY RD	02201	SW SAGERT ST	3	STRGHT	1		N	07		NONE	2	0	UNKNOWN	0	0	0	0	CLR	DRY	DAY	S-STRGHT	REAR	PDO	
00201	00201	SW BOONES FERRY RD	02201	SW SAGERT ST	3	STRGHT	1		N	08		NONE	2	1	UNKNOWN	0	0	0	0	CLR	DRY	DAY	S-1STOP	REAR	INJ	
00201	00201	SW BOONES FERRY RD	02201	SW SAGERT ST	3	STRGHT	1		N	08		NONE	2	1	UNKNOWN	0	0	0	0	CLR	DRY	DAY	S-1STOP	REAR	INJ	
00201	00201	SW BOONES FERRY RD	02201	SW SAGERT ST	3	STRGHT	1		N	08		NONE	2	0	UNKNOWN	0	0	0	0	CLR	DRY	DAY	S-1STOP	REAR	PDO	
00201	00201	SW BOONES FERRY RD	02201	SW SAGERT ST	3	STRGHT	1		N	08		NONE	2	0	UNKNOWN	0	0	0	0	CLR	DRY	DAY	S-1STOP	REAR	PDO	
00201	00201	SW BOONES FERRY RD	02201	SW SAGERT ST	1	INTER	3		E	06	CROSS		0			0	TRF SIGNAL	0	0	0	CLR	DRY	DAY	BIKE	TURN	INJ
00201	00201	SW BOONES FERRY RD	02201	SW SAGERT ST	1	INTER	3	5	E	06	CROSS		0			0	TRF SIGNAL	0	0	0	CLR	DRY	DAY	BIKE	TURN	INJ
00201	00201	SW BOONES FERRY RD	02201	SW SAGERT ST	1	INTER	3		E	06	CROSS		0			0	TRF SIGNAL	0	0	0	CLR	DRY	DAY	ANGL-STP	TURN	INJ
00201	00201	SW BOONES FERRY RD	02201	SW SAGERT ST	1	INTER	3		E	06	CROSS		0			0	TRF SIGNAL	0	0	0	CLR	DRY	DAY	ANGL-STP	TURN	INJ
00201	00201	SW BOONES FERRY RD	02201	SW SAGERT ST	1	INTER	3		E	06	CROSS		0			0	TRF SIGNAL	0	0	0	CLR	DRY	DAY	ANGL-STP	TURN	INJ
00201	00201	SW BOONES FERRY RD	02201	SW SAGERT ST	1	INTER	3		E	06	CROSS		0			0	TRF SIGNAL	0	0	0	CLR	DRY	DAY	ANGL-STP	TURN	INJ
00201	00201	SW BOONES FERRY RD	02201	SW SAGERT ST	1	INTER	3		E	06	CROSS		0			0	TRF SIGNAL	0	0	0	CLR	DRY	DAY	ANGL-STP	TURN	INJ
00201	00201	SW BOONES FERRY RD	02201	SW SAGERT ST	1	INTER	3		E	06	CROSS		0			0	TRF SIGNAL	0	0	0	CLR	DRY	DAY	ANGL-STP	TURN	INJ
00201	00201	SW BOONES FERRY RD	02201	SW SAGERT ST	1	INTER	3		E	06	CROSS		0			0	TRF SIGNAL	0	0	0	CLR	DRY	DAY	ANGL-STP	TURN	INJ
00201	00201	SW BOONES FERRY RD	02201	SW SAGERT ST	1	INTER	3		E	06	CROSS		0			0	TRF SIGNAL	0	0	0	CLR	DRY	DAY	ANGL-STP	TURN	PDO
00201	00201	SW BOONES FERRY RD	02201	SW SAGERT ST	1	INTER	3		E	06	CROSS		0			0	TRF SIGNAL	0	0	0	CLR	DRY	DAY	ANGL-STP	TURN	PDO
00201	00201	SW BOONES FERRY RD	02201	SW SAGERT ST	3	STRGHT	5		S	07		NONE	2	0	UNKNOWN	0	0	0	0	CLR	DRY	DAY	S-STRGHT	REAR	PDO	
00201	00201	SW BOONES FERRY RD	02201	SW SAGERT ST	3	STRGHT	5		S	07		NONE	2	0	UNKNOWN	0	0	0	0	CLR	DRY	DAY	S-STRGHT	REAR	PDO	
00201	00201	SW BOONES FERRY RD	02201	SW SAGERT ST	1	INTER	9		CN	01	CROSS		0			0	TRF SIGNAL	0	0	0	CLR	DRY	DAY	ANGL-OTH	ANGL	PDO
00201	00201	SW BOONES FERRY RD	02201	SW SAGERT ST	1	INTER	9		CN	01	CROSS		0			0	TRF SIGNAL	0	0	0	CLR	DRY	DAY	ANGL-OTH	ANGL	PDO
00201	00201	SW BOONES FERRY RD	02201	SW SAGERT ST	1	INTER	9		CN	02	CROSS		0			0	TRF SIGNAL	0	0	0	RAIN	WET	DAY	ANGL-OTH	ANGL	INJ
00201	00201	SW BOONES FERRY RD	02201	SW SAGERT ST	1	INTER	9		CN	02	CROSS		0			0	TRF SIGNAL	0	0	0	RAIN	WET	DAY	ANGL-OTH	ANGL	INJ
00201	00201	SW BOONES FERRY RD	02201	SW SAGERT ST	1	INTER	9		CN	03	CROSS		0			0	TRF SIGNAL	0	0	0	CLR	DRY	DAY	O-1 L-TURN	TURN	INJ
00201	00201	SW BOONES FERRY RD	02201	SW SAGERT ST	1	INTER	9		CN	03	CROSS		0			0	TRF SIGNAL	0	0	0	CLR	DRY	DAY	O-1 L-TURN	TURN	INJ
00201	00201	SW BOONES FERRY RD	02201	SW SAGERT ST	1	INTER	9		CN	03	CROSS		0			0	TRF SIGNAL	0	0	0	CLR	DRY	DAY	O-1 L-TURN	TURN	PDO
00201	00201	SW BOONES FERRY RD	02201	SW SAGERT ST	1	INTER	9		CN	03	CROSS		0			0	TRF SIGNAL	0	0	0	CLR	DRY	DAY	O-1 L-TURN	TURN	PDO
00201	00201	SW BOONES FERRY RD	02201	SW SAGERT ST	1	INTER	9		CN	03	CROSS		0			0	TRF SIGNAL	0	0	0	CLR	DRY	DUSK	ANGL-OTH	ANGL	PDO
00201	00201	SW BOONES FERRY RD	02201	SW SAGERT ST	1	INTER	9		CN	03	CROSS		0			0	TRF SIGNAL	0	0	0	CLR	DRY	DUSK	ANGL-OTH	ANGL	PDO
00201	00201	SW BOONES FERRY RD	02201	SW SAGERT ST	1	INTER	9		CN	03	CROSS		0			0	TRF SIGNAL	0	0	0	CLR	DRY	DAY	O-1 L-TURN	TURN	INJ
00201	00201	SW BOONES FERRY RD	02201	SW SAGERT ST	1	INTER	9		CN	03	CROSS		0			0	TRF SIGNAL	0	0	0	CLR	DRY	DAY	O-1 L-TURN	TURN	INJ

1. BFR & Sagert

CRASH_EV	CRASH_EV	CRASH_EV	CRASH_CA	CRASH_CA	CRASH_CA	LAT DEG	LAT MINUTE	LAT SEC	LONGTD	LONGTD	LONGTD	VHCL_COD				VHCL_OWNS				VHCL_MVMN				VHCL_CMPSS_D				VHCL_EVN				VHCL_CAU
NT_1_CD	NT_2_CD	NT_3_CD	USE_1_CD	USE_2_CD	USE_3_CD	NO	NO	NO	DEG NO	MINUTE NO	SEC NO	LONG	VHCL_ID	HCL_FLG	O	RT_DESC	HORT_DESC	Y	ESC	SC	T_DESC	DESC	TN_CD	T_1_CD	T_2_CD	T_3_CD	SE_1_CD					
						45	22	31.14	-122	46	3.18	-122.76755	3096490	1	1	PSNGR CAR	NONE		0	PRVTE	STRGHT	N	S	000				00				
						45	22	31.14	-122	46	3.18	-122.76755	3096491	0	2	PSNGR CAR	NONE		0	PRVTE	STOP	N	S	011				00				
						45	22	32.03	-122	46	2.41	-122.7673361	3139049	1	1	PSNGR CAR	NONE		0	PRVTE	STRGHT	N	S	000				00				
						45	22	32.03	-122	46	2.41	-122.7673361	3139050	0	2	PSNGR CAR	NONE		0	PRVTE	STOP	N	S	011				00				
						45	22	32.03	-122	46	2.41	-122.7673361	3139050	0	2	PSNGR CAR	NONE		0	PRVTE	STOP	N	S	011				00				
						45	22	32.06	-122	46	2.38	-122.7673278	3160762	1	1	PSNGR CAR	NONE		0	PRVTE	STRGHT	N	S	000				00				
						45	22	32.06	-122	46	2.38	-122.7673278	3160763	0	2	PSNGR CAR	NONE		0	PRVTE	STOP	N	S	011				00				
						45	22	32.06	-122	46	2.38	-122.7673278	3160763	0	2	PSNGR CAR	NONE		0	PRVTE	STOP	N	S	011				00				
						45	22	32.06	-122	46	2.38	-122.7673278	3160763	0	2	PSNGR CAR	NONE		0	PRVTE	STOP	N	S	011				00				
013						45	22	32.05	-122	46	2.39	-122.7673306	3083258	1	1	PSNGR CAR	NONE		0	PRVTE	STRGHT	S	N	000				00				
013						45	22	32.05	-122	46	2.39	-122.7673306	3083259	0	2	PSNGR CAR	NONE		0	PRVTE	STRGHT	S	N	006	013			00				
013						45	22	32.05	-122	46	2.39	-122.7673306	3083260	0	3	PSNGR CAR	NONE		0	PRVTE	STRGHT	S	N	022				00				
						45	22	32.47	-122	46	2.03	-122.7672306	3177053	1	1	PSNGR CAR	NONE		0	PRVTE	STRGHT	N	S	000				00				
						45	22	32.47	-122	46	2.03	-122.7672306	3177054	0	2	PSNGR CAR	NONE		0	PRVTE	STOP	N	S	011				00				
						45	22	32.47	-122	46	2.03	-122.7672306	3177054	0	2	PSNGR CAR	NONE		0	PRVTE	STOP	N	S	011				00				
						45	22	32.44	-122	46	2.06	-122.7672389	3297651	1	1	PSNGR CAR	NONE		0	PRVTE	STRGHT	N	S	000				00				
						45	22	32.44	-122	46	2.06	-122.7672389	3297652	0	2	PSNGR CAR	NONE		0	PRVTE	STOP	N	S	011				00				
						45	22	32.21	-122	46	2.25	-122.7672917	3502023	1	1	PSNGR CAR	NONE		9	N/A	STRGHT	N	S	000				00				
						45	22	32.21	-122	46	2.25	-122.7672917	3502024	0	2	PSNGR CAR	NONE		9	N/A	STOP	N	S	011				00				
110						45	22	31.14	-122	46	3.18	-122.76755	3045190	1	1	PSNGR CAR	NONE		0	PRVTE	TURN-R	E	N	000				00				
110						45	22	31.14	-122	46	3.18	-122.76755		0																		
			08		32	45	22	31.14	-122	46	3.18	-122.76755	3261541	1	1	PSNGR CAR	NONE		0	PRVTE	TURN-L	N	E	000				00				
			08		32	45	22	31.14	-122	46	3.18	-122.76755	3261542	0	2	PSNGR CAR	NONE		0	PRVTE	STOP	E	W	012				00				
			08		32	45	22	31.14	-122	46	3.18	-122.76755	3261542	0	2	PSNGR CAR	NONE		0	PRVTE	STOP	E	W	012				00				
			08		32	45	22	31.14	-122	46	3.18	-122.76755	3261542	0	2	PSNGR CAR	NONE		0	PRVTE	STOP	E	W	012				00				
			08		32	45	22	31.14	-122	46	3.18	-122.76755	3261542	0	2	PSNGR CAR	NONE		0	PRVTE	STOP	E	W	012				00				
						45	22	31.14	-122	46	3.18	-122.76755	3280181	1	1	PSNGR CAR	NONE		0	PRVTE	TURN-R	S	E	000				00				
						45	22	31.14	-122	46	3.18	-122.76755	3280182	0	2	PSNGR CAR	NONE		0	PRVTE	STOP	E	W	012				00				
						45	22	31.14	-122	46	3.18	-122.76755	3280183	0	3	PSNGR CAR	NONE		0	PRVTE	STOP	E	W	022				00				
						45	22	31.14	-122	46	3.18	-122.76755	3280183	0	3	PSNGR CAR	NONE		0	PRVTE	STOP	E	W	022				00				
						45	22	31.14	-122	46	3.18	-122.76755	3505240	1	1	PSNGR CAR	NONE		9	N/A	TURN-L	N	E	000				00				
						45	22	31.14	-122	46	3.18	-122.76755	3505241	0	2	PSNGR CAR	NONE		9	N/A	STOP	E	W	012				00				
						45	22	29.97	-122	46	4.21	-122.7678361	3432944	1	1	PSNGR CAR	NONE		9	N/A	STRGHT	N	S	000				00				
						45	22	29.97	-122	46	4.21	-122.7678361	3432945	0	2	PSNGR CAR	NONE		9	N/A	STRGHT	N	S	000				00				
			04			45	22	31.14	-122	46	3.18	-122.76755	3201388	1	1	PSNGR CAR	NONE		9	N/A	STRGHT	N	S	000				00				
			04			45	22	31.14	-122	46	3.18	-122.76755	3201389	0	2	PSNGR CAR	NONE		9	N/A	STRGHT	E	W	000				00				
						45	22	31.14	-122	46	3.18	-122.76755	3137882	1	1	PSNGR CAR	NONE		0	PRVTE	STRGHT	E	W	000				00				
						45	22	31.14	-122	46	3.18	-122.76755	3137883	0	2	PSNGR CAR	NONE		0	PRVTE	STRGHT	S	N	000				00				
						45	22	31.14	-122	46	3.18	-122.76755	3381367	1	1	PSNGR CAR	NONE		0	PRVTE	TURN-L	E	S	000				00				
						45	22	31.14	-122	46	3.18	-122.76755	3381368	0	2	PSNGR CAR	NONE		0	PRVTE	STRGHT	W	E	000				00				
						45	22	31.14	-122	46	3.18	-122.76755	3429898	1	1	PSNGR CAR	NONE		9	N/A	TURN-L	E	S	000				00				
						45	22	31.14	-122	46	3.18	-122.76755	3429899	0	2	PSNGR CAR	NONE		9	N/A	STRGHT	W	E	000				00				
						45	22	31.14	-122	46	3.18	-122.76755	3434775	1	1	PSNGR CAR	NONE		9	N/A	STRGHT	N	S	000				00				
						45	22	31.14	-122	46	3.18	-122.76755	3434776	0	2	PSNGR CAR	NONE		9	N/A	STRGHT	W	E	000				00				
						45	22	31.14	-122	46	3.18	-122.76755	3465408	1	1	PSNGR CAR	NONE		0	PRVTE	TURN-L	E	S	000				00				
						45	22	31.14	-122	46	3.18	-122.76755	3465409	0	2	PSNGR CAR	NONE		0	PRVTE	STRGHT	W	E	000				00				

1. BFR & Sagert

VHCL_CAU		PARTIC_TYP		PARTIC_MVM		PARTIC_CMPSS		PARTIC_CMPSS		DRVR_LIC_ST		NON_MOTRST									TOTAL_CR	TOTAL_RO					
SE_2_CD	SE_3_CD	PARTIC_ID	ARTIC_FLG	CL_SEQ_NO	P_CD	C	ESC	T_DESC	_DESC	HORT_DESC	AGE_VAL	SEX_CD	ESC	HORT_DESC	TN_CD	DESC	RR_1_CD	RR_2_CD	RR_3_CD	NT_1_CD	NT_2_CD	NT_3_CD	USE_1_CD	USE_2_CD	USE_3_CD	ASHES	WS
		3535529	0	1	1	DRVR				NONE	21	2	OR-Y	OR<25	000		026						29			293	674
		3535530	0	1	1	DRVR				NONE	34	1	OR-Y	OR>25	000		000						00			293	674
		3580923	0	1	1	DRVR				NONE	15	1	NONE	OR<25	000		026						29			293	674
		3580924	0	1	1	DRVR				INJC	43	2	OR-Y	OR<25	000		000						00			293	674
		3580925	0	2	2	PSNG				INJC	38	1			000		000						00			293	674
		3608187	0	1	1	DRVR				INJB	82	2	OR-Y	OR<25	000		026						29			293	674
		3608188	0	1	1	DRVR				INJC	35	2	OR-Y	OR<25	000		000						00			293	674
		3608189	0	2	2	PSNG				INJC	37	1			000		000						00			293	674
		3608190	0	3	2	PSNG				INJC	03	2			000		000						00			293	674
		3522419	0	1	1	DRVR				NONE	00	1	OR-Y	UNK	000		042						29			293	674
		3522420	0	1	1	DRVR				NONE	16	2	OR-Y	OR<25	000		000						00			293	674
		3522421	0	1	1	DRVR				NONE	00	2	OR-Y	UNK	000		000						00			293	674
		3628515	0	1	1	DRVR				NONE	21	2	OR-Y	OR<25	000		043						07			293	674
		3628516	0	1	1	DRVR				NONE	37	1	OR-Y	OR<25	000		000						00			293	674
		3628517	0	2	2	PSNG				INJC	03	2			000		000						00			293	674
		3763330	0	1	1	DRVR				NONE	28	2	OR-Y	OR<25	000		026						29			293	674
		3763331	0	1	1	DRVR				INJC	38	2	OR-Y	OR<25	000		000						00			293	674
		3989583	0	1	1	DRVR				NONE	00	9	UNK	UNK	000		000						00			293	674
		3989584	0	1	1	DRVR				NONE	00	9	UNK	UNK	000		000						00			293	674
		3475948	0	1	1	DRVR				NONE	34	1	OR-Y	OR<25	000		027						29			293	674
		3475949	0	1	6	BIKE	STRGHT	S	N	INJB	15	2			035	IXWLK	000			110			00			293	674
		3717907	0	1	1	DRVR				NONE	17	2	OR-Y	OR<25	038		016	002	052				27	08	32	293	674
		3717908	0	1	1	DRVR				NONE	32	1	OR-Y	OR<25	000		000						00			293	674
		3717909	0	2	2	PSNG				INJC	32	2			000		000						00			293	674
		3717910	0	3	2	PSNG				NO<5	03	1			000		000						00			293	674
		3717911	0	4	2	PSNG				NO<5	01	2			000		000						00			293	674
		3741305	0	1	1	DRVR				NONE	59	1	OR-Y	OR<25	000		001						08			293	674
		3741306	0	1	1	DRVR				NONE	65	2	OR-Y	OR<25	000		000						00			293	674
		3741307	0	1	1	DRVR				INJA	48	2	OR-Y	OR<25	000		000						00			293	674
		3741308	0	2	2	PSNG				INJA	43	1			000		000						00			293	674
		3992708	0	1	1	DRVR				NONE	00	9	UNK	UNK	000		000						00			293	674
		3992709	0	1	1	DRVR				NONE	00	9	UNK	UNK	000		000						00			293	674
		3910710	0	1	1	DRVR				NONE	00	9	UNK	UNK	000		000						00			293	674
		3910711	0	1	1	DRVR				NONE	00	9	UNK	UNK	000		000						00			293	674
		3654382	0	1	1	DRVR				NONE	00	9	UNK	UNK	000		000						00			293	674
		3654383	0	1	1	DRVR				NONE	00	9	UNK	UNK	000		000						00			293	674
		3579457	0	1	1	DRVR				INJC	32	1	OR-Y	OR<25	000		000						00			293	674
		3579458	0	1	1	DRVR				INJC	52	2	OR-Y	OR<25	000		020						04			293	674
		3855340	0	1	1	DRVR				INJB	21	2	OR-Y	OR<25	000		028	004					02			293	674
		3855341	0	1	1	DRVR				INJC	53	2	OR-Y	OR<25	000		000						00			293	674
		3907805	0	1	1	DRVR				NONE	00	9	UNK	UNK	000		000						00			293	674
		3907806	0	1	1	DRVR				NONE	00	9	UNK	UNK	000		000						00			293	674
		3912457	0	1	1	DRVR				NONE	00	9	UNK	UNK	000		000						00			293	674
		3912458	0	1	1	DRVR				NONE	00	9	UNK	UNK	000		000						00			293	674
		3947972	0	1	1	DRVR				NONE	22	2	OR-Y	OR<25	000		020						04			293	674
		3947973	0	1	1	DRVR				INJC	26	2	OR-Y	OR<25	000		000						00			293	674

2. BFR & Avery

CRASH_ID	INT_ID	SER_NO	INVSTG_AGY				LANE_RDWY				UNLOCK	CRASH_HR_		URB_AREA_SHORT_				HWY_COMPN								
			SHORT_DES	CRASH_SPEE	ALCHL_IN	DRUG_INV	MJ_INVLV	SCHL_ZON	WRK_ZON	DPRT		CRASH	FLG	CRASH_DT	DAY_CD	C	CNTY_NM	CITY_SECT_NM	NM	HWY_NO	HWY_MED_NM	RDWY_NO	FC_CD	HWY_COM	T_SHORT_DE	MLGE_TY
1698592	2	05574	NONE	0	0	0	0	0	0	N	FALSE	8/19/2016	6	3P	Washington	Tualatin	PORTLAND UA				16					
1698592	2	05574	NONE	0	0	0	0	0	0	N	FALSE	8/19/2016	6	3P	Washington	Tualatin	PORTLAND UA				16					
1699263	2	06240	CITY	0	1	0	0	0	0	N	FALSE	9/15/2016	5	8P	Washington	Tualatin	PORTLAND UA				16					
1699263	2	06240	CITY	0	1	0	0	0	0	N	FALSE	9/15/2016	5	8P	Washington	Tualatin	PORTLAND UA				16					
1750185	2	00055	NONE	0	0	0	0	0	0	N	FALSE	1/4/2017	4	7A	Washington	Tualatin	PORTLAND UA				16					
1750185	2	00055	NONE	0	0	0	0	0	0	N	FALSE	1/4/2017	4	7A	Washington	Tualatin	PORTLAND UA				16					
1845208	2	06175	NONE	0	0	0	0	0	0	N	FALSE	11/24/2019	1	1P	Washington	Tualatin	PORTLAND UA				16					
1845208	2	06175	NONE	0	0	0	0	0	0	N	FALSE	11/24/2019	1	1P	Washington	Tualatin	PORTLAND UA				16					
1845208	2	06175	NONE	0	0	0	0	0	0	N	FALSE	11/24/2019	1	1P	Washington	Tualatin	PORTLAND UA				16					
1845208	2	06175	NONE	0	0	0	0	0	0	N	FALSE	11/24/2019	1	1P	Washington	Tualatin	PORTLAND UA				16					
1815247	2	03056	NONE	0	0	0	0	0	0	N	FALSE	6/8/2018	6	4P	Washington	Tualatin	PORTLAND UA				16					
1789994	2	02282	NONE	0	0	0	0	0	0	N	FALSE	5/7/2018	2	7A	Washington	Tualatin	PORTLAND UA				16					
1789994	2	02282	NONE	0	0	0	0	0	0	N	FALSE	5/7/2018	2	7A	Washington	Tualatin	PORTLAND UA				16					
1633241	2	01899	UNK	1	0	0	0	0	0	N	FALSE	4/11/2015	7	12P	Washington	Tualatin	PORTLAND UA				16					
1656198	2	00174	CITY	0	0	0	0	0	0	N	FALSE	1/7/2016	5	2P	Washington	Tualatin	PORTLAND UA				16					
1656198	2	00174	CITY	0	0	0	0	0	0	N	FALSE	1/7/2016	5	2P	Washington	Tualatin	PORTLAND UA				16					
1660058	2	01270	CITY	0	0	0	0	0	0	N	FALSE	2/26/2016	6	12P	Washington	Tualatin	PORTLAND UA				16					
1660058	2	01270	CITY	0	0	0	0	0	0	N	FALSE	2/26/2016	6	12P	Washington	Tualatin	PORTLAND UA				16					
1754417	2	02365	CITY	0	0	0	0	0	0	N	FALSE	4/24/2017	2	11A	Washington	Tualatin	PORTLAND UA				16					
1754417	2	02365	CITY	0	0	0	0	0	0	N	FALSE	4/24/2017	2	11A	Washington	Tualatin	PORTLAND UA				16					
1823666	2	07217	CITY	0	0	0	0	0	0	N	FALSE	12/30/2018	1	10A	Washington	Tualatin	PORTLAND UA				16					
1823666	2	07217	CITY	0	0	0	0	0	0	N	FALSE	12/30/2018	1	10A	Washington	Tualatin	PORTLAND UA				16					
1700744	2	07436	CITY	0	0	0	0	0	0	N	FALSE	10/31/2016	2	7A	Washington	Tualatin	PORTLAND UA				16					
1700744	2	07436	CITY	0	0	0	0	0	0	N	FALSE	10/31/2016	2	7A	Washington	Tualatin	PORTLAND UA				16					
1793813	2	02793	CITY	0	0	0	0	0	0	N	FALSE	6/2/2018	7	7A	Washington	Tualatin	PORTLAND UA				16					
1793813	2	02793	CITY	0	0	0	0	0	0	N	FALSE	6/2/2018	7	7A	Washington	Tualatin	PORTLAND UA				16					
1631948	2	01007	NONE	0	0	0	0	0	0	N	FALSE	2/23/2015	2	6P	Washington	Tualatin	PORTLAND UA				16					
1631948	2	01007	NONE	0	0	0	0	0	0	N	FALSE	2/23/2015	2	6P	Washington	Tualatin	PORTLAND UA				16					
1731007	2	03073	CITY	0	1	0	0	0	0	N	FALSE	5/26/2017	6	6P	Washington	Tualatin	PORTLAND UA				16					
1731007	2	03073	CITY	0	1	0	0	0	0	N	FALSE	5/26/2017	6	6P	Washington	Tualatin	PORTLAND UA				16					
1754421	2	02392	NONE	0	0	0	0	0	0	N	FALSE	4/25/2017	3	4P	Washington	Tualatin	PORTLAND UA				16					
1754421	2	02392	NONE	0	0	0	0	0	0	N	FALSE	4/25/2017	3	4P	Washington	Tualatin	PORTLAND UA				16					
1691200	2	02162	CITY	1	0	0	0	0	0	N	FALSE	4/2/2016	7	3P	Washington	Tualatin	PORTLAND UA				16					
1691200	2	02162	CITY	1	0	0	0	0	0	N	FALSE	4/2/2016	7	3P	Washington	Tualatin	PORTLAND UA				16					
1672010	2	04989	CITY	0	0	0	0	0	0	N	FALSE	7/28/2016	5	4P	Washington	Tualatin	PORTLAND UA				16					
1672010	2	04989	CITY	0	0	0	0	0	0	N	FALSE	7/28/2016	5	4P	Washington	Tualatin	PORTLAND UA				16					
1672010	2	04989	CITY	0	0	0	0	0	0	N	FALSE	7/28/2016	5	4P	Washington	Tualatin	PORTLAND UA				16					
1692991	2	02879	NONE	0	0	0	0	0	0	N	FALSE	5/2/2016	2	10A	Washington	Tualatin	PORTLAND UA				16					
1692991	2	02879	NONE	0	0	0	0	0	0	N	FALSE	5/2/2016	2	10A	Washington	Tualatin	PORTLAND UA				16					
1786794	2	02007	CITY	0	0	0	0	0	0	N	FALSE	4/23/2018	2	4P	Washington	Tualatin	PORTLAND UA				16					
1786794	2	02007	CITY	0	0	0	0	0	0	N	FALSE	4/23/2018	2	4P	Washington	Tualatin	PORTLAND UA				16					
1786794	2	02007	CITY	0	0	0	0	0	0	N	FALSE	4/23/2018	2	4P	Washington	Tualatin	PORTLAND UA				16					
1786794	2	02007	CITY	0	0	0	0	0	0	N	FALSE	4/23/2018	2	4P	Washington	Tualatin	PORTLAND UA				16					
1786794	2	02007	CITY	0	0	0	0	0	0	N	FALSE	4/23/2018	2	4P	Washington	Tualatin	PORTLAND UA				16					
1801656	2	05417	CITY	0	0	0	0	0	0	N	FALSE	10/12/2018	6	2P	Washington	Tualatin	PORTLAND UA				16					
1801656	2	05417	CITY	0	0	0	0	0	0	N	FALSE	10/12/2018	6	2P	Washington	Tualatin	PORTLAND UA				16					
1801656	2	05417	CITY	0	0	0	0	0	0	N	FALSE	10/12/2018	6	2P	Washington	Tualatin	PORTLAND UA				16					
1639110	2	04940	CITY	0	0	0	0	0	0	N	FALSE	8/29/2015	7	4P	Washington	Tualatin	PORTLAND UA				16					
1639110	2	04940	CITY	0	0	0	0	0	0	N	FALSE	8/29/2015	7	4P	Washington	Tualatin	PORTLAND UA				16					
1754701	2	02680	NONE	0	0	0	0	0	0	N	FALSE	5/8/2017	2	3P	Washington	Tualatin	PORTLAND UA				16					
1754701	2	02680	NONE	0	0	0	0	0	0	N	FALSE	5/8/2017	2	3P	Washington	Tualatin	PORTLAND UA				16					

2. BFR & Avery

MP_NO	ST_NO	ST_NM	ISECT_ST_		RD_CHAR_CD	RD_CHAR_S	CMPSS_DI	CMPSS_DIR	SHORT_DE	IMPCT_L	MEDN_TYP_		TURNG_LE	TRAF_CNTL_DE				WTHR_CON		LGT_COND_		COLLIS_TYP_		CRASH_SVR
			NO	ISECT_ST_NM							HORT_DESC	R_CD		FROM_CD	SC	OC_CD	HORT_DESC	C	G_QTY	LN_QTY	FLG	SC	Y_FLG	LG
00101	SW AVERY ST	00201	SW BOONES FERRY RD	1	INTER	2	NE	06	CROSS			0		0	TRF SIGNAL	0	0	0	CLR	DRY	DAY	S-1STOP	REAR	PDO
00101	SW AVERY ST	00201	SW BOONES FERRY RD	1	INTER	2	NE	06	CROSS			0		0	TRF SIGNAL	0	0	0	CLR	DRY	DAY	S-1STOP	REAR	PDO
00101	SW AVERY ST	00201	SW BOONES FERRY RD	1	INTER	2	NE	06	CROSS			0		0	TRF SIGNAL	0	0	0	CLR	DRY	DLIT	S-STRGHT	REAR	PDO
00101	SW AVERY ST	00201	SW BOONES FERRY RD	1	INTER	2	NE	06	CROSS			0		0	TRF SIGNAL	0	0	0	CLR	DRY	DAWN	S-1STOP	REAR	PDO
00101	SW AVERY ST	00201	SW BOONES FERRY RD	1	INTER	2	NE	06	CROSS			0		0	TRF SIGNAL	0	0	0	CLR	DRY	DAWN	S-1STOP	REAR	PDO
00101	SW AVERY ST	00201	SW BOONES FERRY RD	1	INTER	2	NE	06	CROSS			0		0	TRF SIGNAL	0	0	0	CLR	DRY	DAY	S-1STOP	REAR	INJ
00101	SW AVERY ST	00201	SW BOONES FERRY RD	1	INTER	2	NE	06	CROSS			0		0	TRF SIGNAL	0	0	0	CLR	DRY	DAY	S-1STOP	REAR	INJ
00101	SW AVERY ST	00201	SW BOONES FERRY RD	1	INTER	3	E	05	CROSS			0		0	TRF SIGNAL	1	0	0	UNK	UNK	DAY	FIX OBJ	FIX	PDO
00101	SW AVERY ST	00201	SW BOONES FERRY RD	1	INTER	3	E	06	CROSS			0		0	TRF SIGNAL	0	0	0	CLR	DRY	DAY	S-1STOP	REAR	INJ
00101	SW AVERY ST	00201	SW BOONES FERRY RD	1	INTER	6	SW	05	CROSS			0		0	TRF SIGNAL	1	0	0	CLR	DRY	DAY	FIX OBJ	FIX	PDO
00101	SW AVERY ST	00201	SW BOONES FERRY RD	1	INTER	6	SW	05	CROSS			0		0	UNKNOWN	0	0	0	CLD	DRY	DAY	S-1STOP	REAR	INJ
00101	SW AVERY ST	00201	SW BOONES FERRY RD	1	INTER	6	SW	05	CROSS			0		0	UNKNOWN	0	0	0	CLD	DRY	DAY	S-1STOP	REAR	INJ
00101	SW AVERY ST	00201	SW BOONES FERRY RD	1	INTER	6	SW	06	CROSS			0		0	TRF SIGNAL	0	0	0	CLD	DRY	DAY	S-1STOP	REAR	INJ
00101	SW AVERY ST	00201	SW BOONES FERRY RD	1	INTER	6	SW	06	CROSS			0		0	TRF SIGNAL	0	0	0	CLD	DRY	DAY	S-1STOP	REAR	INJ
00101	SW AVERY ST	00201	SW BOONES FERRY RD	1	INTER	6	SW	06	CROSS			0		0	TRF SIGNAL	0	0	0	RAIN	WET	DAY	S-1STOP	REAR	PDO
00101	SW AVERY ST	00201	SW BOONES FERRY RD	1	INTER	6	SW	06	CROSS			0		0	TRF SIGNAL	0	0	0	RAIN	WET	DAY	S-1STOP	REAR	PDO
00101	SW AVERY ST	00201	SW BOONES FERRY RD	1	INTER	6	SW	06	CROSS			0		0	TRF SIGNAL	0	0	0	CLR	DRY	DAY	S-1STOP	REAR	PDO
00101	SW AVERY ST	00201	SW BOONES FERRY RD	1	INTER	6	SW	06	CROSS			0		0	TRF SIGNAL	0	0	0	CLR	DRY	DAY	S-1STOP	REAR	PDO
00101	SW AVERY ST	00201	SW BOONES FERRY RD	1	INTER	9	CN	01	CROSS			0		0	TRF SIGNAL	0	0	0	RAIN	WET	DLIT	ANGL-OTH	TURN	PDO
00101	SW AVERY ST	00201	SW BOONES FERRY RD	1	INTER	9	CN	01	CROSS			0		0	TRF SIGNAL	0	0	0	RAIN	WET	DLIT	ANGL-OTH	TURN	PDO
00101	SW AVERY ST	00201	SW BOONES FERRY RD	1	INTER	9	CN	01	CROSS			0		0	TRF SIGNAL	0	0	0	CLR	DRY	DAY	O-1 L-TURN	TURN	INJ
00101	SW AVERY ST	00201	SW BOONES FERRY RD	1	INTER	9	CN	01	CROSS			0		0	TRF SIGNAL	0	0	0	CLR	DRY	DAY	O-1 L-TURN	TURN	INJ
00101	SW AVERY ST	00201	SW BOONES FERRY RD	1	INTER	9	CN	03	CROSS			0		0	TRF SIGNAL	0	0	0	CLR	DRY	DLIT	O-OTHER	TURN	PDO
00101	SW AVERY ST	00201	SW BOONES FERRY RD	1	INTER	9	CN	03	CROSS			0		0	TRF SIGNAL	0	0	0	CLR	DRY	DLIT	O-OTHER	TURN	PDO
00201	SW BOONES FERRY RD	00101	SW AVERY ST	3	STRGHT	2	NE	06		NONE			2	0	NONE	0	0	0	CLR	DRY	DAY	S-1STOP	REAR	INJ
00201	SW BOONES FERRY RD	00101	SW AVERY ST	3	STRGHT	2	NE	06		NONE			2	0	NONE	0	0	0	CLR	DRY	DAY	S-1STOP	REAR	INJ
00201	SW BOONES FERRY RD	00101	SW AVERY ST	3	STRGHT	2	NE	06		NONE			2	0	UNKNOWN	0	0	0	RAIN	WET	DAY	S-1STOP	REAR	PDO
00201	SW BOONES FERRY RD	00101	SW AVERY ST	3	STRGHT	2	NE	06		NONE			2	0	UNKNOWN	0	0	0	RAIN	WET	DAY	S-1STOP	REAR	PDO
00201	SW BOONES FERRY RD	00101	SW AVERY ST	3	STRGHT	2	NE	08		NONE			2	0	NONE	0	0	0	CLR	DRY	DAY	S-1STOP	REAR	PDO
00201	SW BOONES FERRY RD	00101	SW AVERY ST	3	STRGHT	2	NE	08		NONE			2	0	NONE	0	0	0	CLR	DRY	DAY	S-1STOP	REAR	PDO
00201	SW BOONES FERRY RD	00101	SW AVERY ST	3	STRGHT	6	SW	07		NONE			2	1	NONE	0	0	0	CLR	DRY	DAY	S-1STOP	REAR	INJ
00201	SW BOONES FERRY RD	00101	SW AVERY ST	3	STRGHT	6	SW	07		NONE			2	1	NONE	0	0	0	CLR	DRY	DAY	S-1STOP	REAR	INJ
00201	SW BOONES FERRY RD	00101	SW AVERY ST	3	STRGHT	6	SW	07		NONE			2	0	UNKNOWN	0	0	0	CLR	DRY	DAY	S-1STOP	REAR	PDO
00201	SW BOONES FERRY RD	00101	SW AVERY ST	3	STRGHT	6	SW	07		NONE			2	0	UNKNOWN	0	0	0	CLR	DRY	DAY	S-1STOP	REAR	INJ
00201	SW BOONES FERRY RD	00101	SW AVERY ST	3	STRGHT	6	SW	07		NONE			2	0	UNKNOWN	0	0	0	CLR	DRY	DAY	S-1STOP	REAR	INJ
00201	SW BOONES FERRY RD	00101	SW AVERY ST	3	STRGHT	6	SW	07		NONE			2	0	UNKNOWN	0	0	0	CLR	DRY	DAY	S-1STOP	REAR	INJ
00201	SW BOONES FERRY RD	00101	SW AVERY ST	3	STRGHT	6	SW	07		NONE			2	0	UNKNOWN	0	0	0	CLR	DRY	DAY	S-1STOP	REAR	INJ
00201	SW BOONES FERRY RD	00101	SW AVERY ST	3	STRGHT	6	SW	07		NONE			2	0	UNKNOWN	0	0	0	CLR	DRY	DAY	S-1STOP	REAR	INJ
00201	SW BOONES FERRY RD	00101	SW AVERY ST	3	STRGHT	6	SW	07		NONE			2	0	UNKNOWN	0	0	0	CLR	DRY	DAY	S-1STOP	REAR	INJ
00201	SW BOONES FERRY RD	00101	SW AVERY ST	3	STRGHT	6	SW	07		NONE			2	0	UNKNOWN	0	0	0	CLR	DRY	DAY	S-1STOP	REAR	INJ
00201	SW BOONES FERRY RD	00101	SW AVERY ST	3	STRGHT	6	SW	07		NONE			2	0	UNKNOWN	0	0	0	CLR	DRY	DAY	S-1STOP	REAR	INJ
00201	SW BOONES FERRY RD	00101	SW AVERY ST	3	STRGHT	6	SW	08		NONE			2	0	UNKNOWN	0	0	0	CLR	DRY	DAY	S-1STOP	REAR	PDO
00201	SW BOONES FERRY RD	00101	SW AVERY ST	2	ALLEY	6	SW	08		NONE			3	0	UNKNOWN	0	0	0	CLR	DRY	DAY	ANGL-OTH	TURN	PDO
00201	SW BOONES FERRY RD	00101	SW AVERY ST	2	ALLEY	6	SW	08		NONE			3	0	UNKNOWN	0	0	0	CLR	DRY	DAY	ANGL-OTH	TURN	PDO

2. BFR & Avery

CRASH_EV			CRASH_CA			LAT			LONGTD			VHCL_COD				VHCL_OWNS				VHCL_CMPSS_D			VHCL_EVN			VHCL_CAU
NT_1_CD	NT_2_CD	NT_3_CD	USE_1_CD	USE_2_CD	USE_3_CD	DEG	MINUTE	SEC	DEG	MINUTE	SEC	NO	NO	NO	RT_DESC	HORT_DESC	ESC	T_SHORT_DE	IR_FROM_SHOR	IR_TO_SHORT_	TN_CD	T_1_CD	T_2_CD	T_3_CD	SE_1_CD	
						45	22	18.14	-122	46	14.61	-122.770725	3205929	1	PSNGR CAR	NONE	9	N/A	STRGHT	NE	SW	000			00	
						45	22	18.14	-122	46	14.61	-122.770725	3205930	0	2	PSNGR CAR	NONE	9	N/A	STOP	NE	SW	011			00
	07		33			45	22	18.14	-122	46	14.61	-122.770725	3207175	1	1	PSNGR CAR	NONE	9	N/A	STRGHT	NE	SW	000			00
	07		33			45	22	18.14	-122	46	14.61	-122.770725	3207176	0	2	PSNGR CAR	NONE	9	N/A	STRGHT	NE	SW	000			00
	29					45	22	18.14	-122	46	14.61	-122.770725	3301581	1	1	PSNGR CAR	NONE	9	N/A	STRGHT	NE	SW	000			00
	29					45	22	18.14	-122	46	14.61	-122.770725	3301582	0	2	PSNGR CAR	NONE	9	N/A	STOP	NE	SW	011			00
	29					45	22	18.14	-122	46	14.61	-122.770725	3475505	1	1	PSNGR CAR	NONE	0	PRVTE	STRGHT	NE	SW	000			00
	29					45	22	18.14	-122	46	14.61	-122.770725	3475506	0	2	PSNGR CAR	NONE	0	PRVTE	STOP	NE	SW	011			00
	29					45	22	18.14	-122	46	14.61	-122.770725	3475506	0	2	PSNGR CAR	NONE	0	PRVTE	STOP	NE	SW	011			00
	29					45	22	18.14	-122	46	14.61	-122.770725	3475506	0	2	PSNGR CAR	NONE	0	PRVTE	STOP	NE	SW	011			00
053						45	22	18.14	-122	46	14.61	-122.770725	3420144	1	1	SEMI TOW	NONE	9	N/A	TURN-R	SW	E	000			00
	29					45	22	18.14	-122	46	14.61	-122.770725	3373690	1	1	PSNGR CAR	NONE	0	PRVTE	STRGHT	E	W	000			00
	29					45	22	18.14	-122	46	14.61	-122.770725	3373691	0	2	PSNGR CAR	NONE	0	PRVTE	STOP	E	W	012			00
053						45	22	18.14	-122	46	14.61	-122.770725	3084569	1	1	PSNGR CAR	NONE	0	PRVTE	TURN-L	E	SW	000	053		00
	29					45	22	18.14	-122	46	14.61	-122.770725	3126905	1	1	PSNGR CAR	NONE	0	PRVTE	STRGHT	NE	SW	000			00
	29					45	22	18.14	-122	46	14.61	-122.770725	3126906	0	2	PSNGR CAR	NONE	0	PRVTE	STOP	NE	SW	011			00
	07					45	22	18.14	-122	46	14.61	-122.770725	3134022	1	1	PSNGR CAR	NONE	0	PRVTE	STRGHT	SW	NE	000			00
	07					45	22	18.14	-122	46	14.61	-122.770725	3134023	0	2	PSNGR CAR	NONE	0	PRVTE	STOP	SW	NE	011			00
	29		32			45	22	18.14	-122	46	14.61	-122.770725	3308975	1	1	PSNGR CAR	NONE	9	N/A	STRGHT	SW	NE	000			00
	29		32			45	22	18.14	-122	46	14.61	-122.770725	3308976	0	2	SEMI TOW	NONE	9	N/A	STOP	SW	NE	011			00
	17		29			45	22	18.14	-122	46	14.61	-122.770725	3434675	1	1	PSNGR CAR	NONE	9	N/A	STRGHT	SW	NE	000			00
	17		29			45	22	18.14	-122	46	14.61	-122.770725	3434676	0	2	PSNGR CAR	NONE	9	N/A	STOP	SW	NE	011			00
	02					45	22	18.14	-122	46	14.61	-122.770725	3209837	1	1	PSNGR CAR	NONE	9	N/A	STRGHT	NE	SW	000			00
	02					45	22	18.14	-122	46	14.61	-122.770725	3209838	0	2	PSNGR CAR	NONE	9	N/A	TURN-L	E	SW	000			00
	27		02			45	22	18.14	-122	46	14.61	-122.770725	3381016	1	1	PSNGR CAR	NONE	0	PRVTE	TURN-L	SW	W	000			00
	27		02			45	22	18.14	-122	46	14.61	-122.770725	3381017	0	2	PSNGR CAR	NONE	0	PRVTE	STRGHT	NE	SW	000			00
	02					45	22	18.14	-122	46	14.61	-122.770725	3082125	1	1	PSNGR CAR	NONE	0	PRVTE	TURN-R	W	SW	000			00
	02					45	22	18.14	-122	46	14.61	-122.770725	3082126	0	2	PSNGR CAR	NONE	0	PRVTE	TURN-L	E	SW	000			00
	07					45	22	18.85	-122	46	13.99	-122.770528	3265469	1	1	PSNGR CAR	NONE	0	PRVTE	STRGHT	NE	SW	000			00
	07					45	22	18.85	-122	46	13.99	-122.770528	3265470	0	2	PSNGR CAR	NONE	0	PRVTE	STOP	NE	SW	011			00
	29					45	22	18.86	-122	46	13.98	-122.77055	3308983	1	1	PSNGR CAR	NONE	9	N/A	STRGHT	NE	SW	000			00
	29					45	22	18.86	-122	46	13.98	-122.77055	3308984	0	2	PSNGR CAR	NONE	9	N/A	STOP	NE	SW	011			00
	27		01	29		45	22	19.27	-122	46	13.61	-122.7704472	3193075	1	1	PSNGR CAR	NONE	9	N/A	STRGHT	NE	SW	000			00
	27		01	29		45	22	19.27	-122	46	13.61	-122.7704472	3193076	0	2	PSNGR CAR	NONE	9	N/A	STOP	NE	SW	011			00
	07					45	22	16.01	-122	46	16.48	-122.7712444	3156619	1	1	PSNGR CAR	NONE	0	PRVTE	STRGHT	NE	SW	000			00
	07					45	22	16.01	-122	46	16.48	-122.7712444	3156619	1	1	PSNGR CAR	NONE	0	PRVTE	STRGHT	NE	SW	000			00
	07					45	22	16.01	-122	46	16.48	-122.7712444	3156620	0	2	PSNGR CAR	NONE	0	PRVTE	STOP	NE	SW	011			00
	29					45	22	16.43	-122	46	16.11	-122.7711417	3196181	1	1	PSNGR CAR	NONE	9	N/A	STRGHT	NE	SW	000			00
	29					45	22	16.43	-122	46	16.11	-122.7711417	3196182	0	2	PSNGR CAR	NONE	9	N/A	STOP	NE	SW	012			00
	17		29			45	22	16.8	-122	46	15.78	-122.77105	3367625	1	1	PSNGR CAR	NONE	0	PRVTE	STRGHT	NE	SW	000			00
	17		29			45	22	16.8	-122	46	15.78	-122.77105	3367626	0	2	PSNGR CAR	NONE	0	PRVTE	STOP	NE	SW	011			00
	17		29			45	22	16.8	-122	46	15.78	-122.77105	3367626	0	2	PSNGR CAR	NONE	0	PRVTE	STOP	NE	SW	011			00
	17		29			45	22	16.8	-122	46	15.78	-122.77105	3367626	0	2	PSNGR CAR	NONE	0	PRVTE	STOP	NE	SW	011			00
	27		29			45	22	16.9	-122	46	15.68	-122.7710222	3396042	1	1	PSNGR CAR	NONE	0	PRVTE	STRGHT	NE	SW	000			00
	27		29			45	22	16.9	-122	46	15.68	-122.7710222	3396043	0	2	PSNGR CAR	NONE	0	PRVTE	STOP	NE	SW	011			00
	27		29			45	22	16.9	-122	46	15.68	-122.7710222	3396043	0	2	PSNGR CAR	NONE	0	PRVTE	STOP	NE	SW	011			00
	07					45	22	16.41	-122	46	16.13	-122.7711472	3095364	1	1	PSNGR CAR	NONE	0	PRVTE	STRGHT	SW	NE	000			00
	07					45	22	16.41	-122	46	16.13	-122.7711472	3095365	0	2	PSNGR CAR	NONE	0	PRVTE	STOP	SW	NE	011			00
	02					45	22	16.39	-122	46	16.15	-122.7711528	3309493	1	1	PSNGR CAR	NONE	9	N/A	TURN-L	E	SW	018			00
	02					45	22	16.39	-122	46	16.15	-122.7711528	3309494	0	2	PSNGR CAR	NONE	9	N/A	STRGHT	SW	NE	000			00

2. BFR & Avery

VHCL_CAU		STRIK_P		PARTIC_TYP	PARTIC_MVM	PARTIC_CMPSS	PARTIC_CMPSS	DRVR_LIC_ST					NON_MOTRST							TOTAL_CR	TOTAL_RO							
SE_2_CD	SE_3_CD	PARTIC_ID	ARTIC_FLG	CL_SEQ_NO	P_CD	C	ESC	T_DESC	_DESC	HORT_DESC	AGE_VAL	SEX_CD	ESC	AT_SHORT_D	HORT_DESC	TN_CD	DESC	RR_1_CD	RR_2_CD	RR_3_CD	NT_1_CD	NT_2_CD	NT_3_CD	USE_1_CD	USE_2_CD	USE_3_CD	ASHES	WS
		3658813	0	1	1	DRVR				NONE	00	9	UNK	UNK	000			000						00			293	674
		3658814	0	1	1	DRVR				NONE	00	9	UNK	UNK	000			000						00			293	674
		3660026	0	1	1	DRVR				NONE	00	9	UNK	UNK	000			000						00			293	674
		3660027	0	1	1	DRVR				NONE	00	9	UNK	UNK	000			000						00			293	674
		3767363	0	1	1	DRVR				NONE	00	9	UNK	UNK	000			000						00			293	674
		3767364	0	1	1	DRVR				NONE	00	9	UNK	UNK	000			000						00			293	674
		3960069	0	1	1	DRVR				NONE	32	1	UNK	UNK	000			026						29			293	674
		3960070	0	1	1	DRVR				INJC	47	1	OR-Y	OR<25	000			000						00			293	674
		3960071	0	2	2	PSNG				INJC	47	2			000			000						00			293	674
		3960072	0	3	2	PSNG				INJC	07	1			000			000						00			293	674
		3960073	0	4	2	PSNG				INJC	12	2			000			000						00			293	674
		3898348	0	1	1	DRVR				NONE	00	9	UNK	UNK	000			000						00			293	674
		3845746	0	1	1	DRVR				NONE	45	2	OR-Y	OR<25	000			026						29			293	674
		3845747	0	1	1	DRVR				INJC	27	1	OR-Y	OR<25	000			000						00			293	674
		3523716	0	1	1	DRVR				NONE	19	1	OR-Y	OR<25	000			047	080	081				01			293	674
		3565772	0	1	1	DRVR				NONE	51	1	OR-Y	OR<25	000			026						29			293	674
		3565773	0	1	1	DRVR				INJC	29	1	OR-Y	OR<25	000			000						00			293	674
		3574629	0	1	1	DRVR				NONE	17	1	OR-Y	OR<25	000			043						07			293	674
		3574630	0	1	1	DRVR				INJC	36	1	OR-Y	OR<25	000			000						00			293	674
		3774632	0	1	1	DRVR				NONE	00	9	UNK	UNK	000			000						00			293	674
		3774633	0	1	1	DRVR				NONE	00	9	UNK	UNK	000			000						00			293	674
		3912365	0	1	1	DRVR				NONE	00	9	UNK	UNK	000			000						00			293	674
		3912366	0	1	1	DRVR				NONE	00	9	UNK	UNK	000			000						00			293	674
		3662620	0	1	1	DRVR				NONE	00	9	UNK	UNK	000			000						00			293	674
		3662621	0	1	1	DRVR				NONE	00	9	UNK	UNK	000			000						00			293	674
		3854919	0	1	1	DRVR				NONE	58	1	OR-Y	OR<25	038			016	028	004				27	02		293	674
		3854920	0	1	1	DRVR				INJC	59	2	OR-Y	OR<25	000			000						00			293	674
		3521308	0	1	1	DRVR				NONE	17	2	OR-Y	OR<25	000			028						02			293	674
		3521309	0	1	1	DRVR				NONE	30	1	OR-Y	OR<25	000			000						00			293	674
		3722863	0	1	1	DRVR				NONE	49	1	SUSP	OR<25	000			043						07			293	674
		3722864	0	1	1	DRVR				INJC	29	1	OR-Y	OR<25	000			000						00			293	674
		3774640	0	1	1	DRVR				NONE	00	9	UNK	UNK	000			000						00			293	674
		3774641	0	1	1	DRVR				NONE	00	9	UNK	UNK	000			000						00			293	674
		3646310	0	1	1	DRVR				NONE	00	9	UNK	UNK	000			000						00			293	674
		3646311	0	1	1	DRVR				NONE	00	9	UNK	UNK	000			000						00			293	674
		3603072	0	1	1	DRVR				INJB	24	2	OR-Y	OR>25	000			043						07			293	674
		3603073	0	2	2	PSNG				INJC	29	1			000			000						00			293	674
		3603074	0	1	1	DRVR				INJC	45	2	OR-Y	OR<25	000			000						00			293	674
		3649312	0	1	1	DRVR				NONE	00	9	UNK	UNK	000			000						00			293	674
		3649313	0	1	1	DRVR				NONE	00	9	UNK	UNK	000			000						00			293	674
		3838049	0	1	1	DRVR				NONE	24	2	OR-Y	OR<25	028			026						17	29		293	674
		3838050	0	1	1	DRVR				INJC	41	2	OR-Y	OR<25	000			000						00			293	674
		3838051	0	2	2	PSNG				INJC	41	1			000			000						00			293	674
		3838052	0	3	2	PSNG				NONE	01	2			000			000						00			293	674
		3838053	0	4	2	PSNG				NONE	03	1			000			000						00			293	674
		3873895	0	1	1	DRVR				INJC	25	2	OR-Y	OR<25	038			016	026					27	29		293	674
		3873896	0	1	1	DRVR				NONE	60	2	OR-Y	OR<25	000			000						00			293	674
		3873897	0	2	2	PSNG				INJC	57	2			000			000						00			293	674
		3534399	0	1	1	DRVR				NONE	18	2	OR-Y	OR<25	000			043						07			293	674
		3534400	0	1	1	DRVR				NONE	49	1	OR-Y	OR<25	000			000						00			293	674
		3775135	0	1	1	DRVR				NONE	00	9	UNK	UNK	000			000						00			293	674
		3775136	0	1	1	DRVR				NONE	00	9	UNK	UNK	000			000						00			293	674

3. BFR & Ibach

INVTG_AGY			LANE RDWY										CRASH_HR_			HWY_COMPN										
CRASH_ID	INT_ID	SER_NO	SHORT_DES	CRASH_SPEE	ALCHL_IN	DRUG_INV	MJ_INVLV	SCHL_ZON	WRK_ZON	DPRT	CRASH	UNLOCT	CRASH_DT	CRASH_WK	SHORT_DES	URB_AREA_SHORT_	HWY_NO	HWY_MED_NM	RDWY_NO	FC_CD	HWY_COM	T_SHORT_DE	MLGE_TY	RD_CON_	LRS	VAL
			C	D_INVLV_FLG	VLV_FLG	LV_FLG	_FLG	E_IND	E_IND	FLG	FLG	FLG		_DAY_CD	C	CNTY_NM	CITY_SECT_NM	NM								
1729167	3	02244	CITY	0	0	0		0	0	N	FALSE	4/19/2017	4	11A	Washington	Tualatin	PORTLAND UA			16						
1729167	3	02244	CITY	0	0	0		0	0	N	FALSE	4/19/2017	4	11A	Washington	Tualatin	PORTLAND UA			16						
1729778	3	02506	CITY	0	0	0		0	0	N	FALSE	5/1/2017	2	3P	Washington	Tualatin	PORTLAND UA			16						
1729778	3	02506	CITY	0	0	0		0	0	N	FALSE	5/1/2017	2	3P	Washington	Tualatin	PORTLAND UA			16						
1700410	3	06988	CITY	0	0	0		0	0	N	FALSE	10/13/2016	5	7P	Washington	Tualatin	PORTLAND UA			16						
1700410	3	06988	CITY	0	0	0		0	0	N	FALSE	10/13/2016	5	7P	Washington	Tualatin	PORTLAND UA			16						
1679093	3	07632	CITY	1	0	0		0	0	N	FALSE	11/6/2016	1	12A	Washington	Tualatin	PORTLAND UA			16						
1799098	3	04369	CITY	0	0	0		0	0	N	FALSE	8/22/2018	4	8A	Washington	Tualatin	PORTLAND UA			16						
1799098	3	04369	CITY	0	0	0		0	0	N	FALSE	8/22/2018	4	8A	Washington	Tualatin	PORTLAND UA			16						
1735720	3	05938	CITY	0	0	0		0	0	N	FALSE	9/25/2017	2	7P	Washington	Tualatin	PORTLAND UA			16						
1735720	3	05938	CITY	0	0	0		0	0	N	FALSE	9/25/2017	2	7P	Washington	Tualatin	PORTLAND UA			16						

3. BFR & Ibach

MP_NO	ST_NO	ST_NM	ISECT_ST_		RD_CHAR_CD	RD_CHAR_S	CMPSS_DI	CMPSS_DIR			IMPCT_L	MEDN_TYP_		TURNG_LE	TRAF_CNTL_DE				WTHR_CON			LGT_COND_		COLLIS_TYP_		CRASH_SVR
			NO	ISECT_ST_NM				R_CD	FROM_CD	SC		OC_CD	HORT_DESC		C	G_QTY	LN_QTY	ISECT_REL_FLG	VICE_SHORT_DE	OFF_RDW	RNDABT_F	DRVWY_R	D_SHORT_D	RD_SURF_S	SHORT_DES	CRASH_TYP_SH
00201	00201	SW BOONES FERRY RD	01101	SW IBACH ST	1	INTER	1		N	06	CROSS		0	0	0	TRF SIGNAL	0	0	0	0	RAIN	WET	DAY	S-1TURN	REAR	INJ
00201	00201	SW BOONES FERRY RD	01101	SW IBACH ST	1	INTER	1		N	06	CROSS		0	0	0	TRF SIGNAL	0	0	0	0	RAIN	WET	DAY	S-1TURN	REAR	INJ
00201	00201	SW BOONES FERRY RD	01101	SW IBACH ST	3	STRGHT	1		N	06		NONE	2	0	0	TRF SIGNAL	0	0	0	0	CLD	DRY	DAY	S-1STOP	REAR	INJ
00201	00201	SW BOONES FERRY RD	01101	SW IBACH ST	3	STRGHT	1		N	06		NONE	2	0	0	TRF SIGNAL	0	0	0	0	CLD	DRY	DAY	S-1STOP	REAR	INJ
00201	00201	SW BOONES FERRY RD	01101	SW IBACH ST	1	INTER	5		S	05	CROSS		0	0	0	TRF SIGNAL	0	0	0	0	RAIN	WET	DLIT	ANGL-OTH	TURN	PDO
00201	00201	SW BOONES FERRY RD	01101	SW IBACH ST	1	INTER	5		S	05	CROSS		0	0	0	TRF SIGNAL	0	0	0	0	RAIN	WET	DLIT	ANGL-OTH	TURN	PDO
00201	00201	SW BOONES FERRY RD	01106	SW IBACH CT	1	INTER	5		S	05	CROSS		0	0	0	TRF SIGNAL	1	0	0	0	CLD	WET	DLIT	FIX OBJ	FIX	INJ
00201	00201	SW BOONES FERRY RD	01106	SW IBACH CT	1	INTER	5		S	06	CROSS		0	0	0	TRF SIGNAL	0	0	0	0	SMOK	DRY	DAY	S-1STOP	REAR	INJ
00201	00201	SW BOONES FERRY RD	01106	SW IBACH CT	1	INTER	5		S	06	CROSS		0	0	0	TRF SIGNAL	0	0	0	0	SMOK	DRY	DAY	S-1STOP	REAR	INJ
00201	00201	SW BOONES FERRY RD	01106	SW IBACH CT	1	INTER	7		W	05	CROSS		0	0	0	TRF SIGNAL	0	0	0	0	CLR	DRY	DUSK	PED	PED	INJ
00201	00201	SW BOONES FERRY RD	01106	SW IBACH CT	1	INTER	7	1	W	05	CROSS		0	0	0	TRF SIGNAL	0	0	0	0	CLR	DRY	DUSK	PED	PED	INJ

3. BFR & Ibach

CRASH_EV			CRASH_CA			LAT			LONGTD				VHCL_COD				VHCL_OWNS				VHCL_MVMN				VHCL_CMPSS_D				VHCL_EVN				VHCL_CAU
NT_1_CD	NT_2_CD	NT_3_CD	USE_1_CD	USE_2_CD	USE_3_CD	DEG NO	MINUTE NO	SEC NO	LAT	DEG NO	MINUTE NO	SEC NO	LONG	VHCL_ID	HCL_FLG	O	RT_DESC	HORT_DESC	Y	ESC	SC	T_DESC	DESC	TN_CD	T_1_CD	T_2_CD	T_3_CD	SE_1_CD					
			07			45	21	38.63	45.36073056	-122	46	28.26	-122.7745167	3262072	1	1	PSNGR CAR	NONE		0	PRVTE	STRGHT	N	S	000				00				
			07			45	21	38.63	45.36073056	-122	46	28.26	-122.7745167	3262073	0	2	PSNGR CAR	NONE		0	PRVTE	TURN-R	N	W	000				00				
			27	29		45	21	39.38	45.36093889	-122	46	27.77	-122.7743806	3263196	1	1	PSNGR CAR	NONE		0	PRVTE	STRGHT	N	S	000				00				
			27	29		45	21	39.38	45.36093889	-122	46	27.77	-122.7743806	3263197	0	2	PSNGR CAR	NONE		0	PRVTE	STOP	N	S	011				00				
			02			45	21	38.63	45.36073056	-122	46	28.26	-122.7745167	3209234	1	1	PSNGR CAR	NONE		9	N/A	STRGHT	N	S	000				00				
			02			45	21	38.63	45.36073056	-122	46	28.26	-122.7745167	3209235	0	2	PSNGR CAR	NONE		9	N/A	TURN-R	W	S	000				00				
054			08	30		45	21	38.63	45.36073056	-122	46	28.26	-122.7745167	3170253	1	1	PSNGR CAR	NONE		0	PRVTE	TURN-L	E	S	000	054			00				
			27	07		45	21	38.63	45.36073056	-122	46	28.26	-122.7745167	3391211	1	1	PSNGR CAR	NONE		0	PRVTE	STRGHT	S	N	000				00				
			27	07		45	21	38.63	45.36073056	-122	46	28.26	-122.7745167	3391212	0	2	PSNGR CAR	NONE		0	PRVTE	STOP	S	N	011				00				
			02			45	21	38.63	45.36073056	-122	46	28.26	-122.7745167	3274476	1	1	PSNGR CAR	NONE		0	PRVTE	TURN-L	S	W	000				00				
			02			45	21	38.63	45.36073056	-122	46	28.26	-122.7745167		0																		

3. BFR & Ibach

VHCL_CAU		STRIKG_P		PARTIC_TYP	PARTIC_MVM	PARTIC_CMPSS_	PARTIC_CMPSS_	DRVR_LIC_ST				NON_MOTRST										TOTAL_CR	TOTAL_RO					
SE_2_CD	SE_3_CD	PARTIC_ID	ARTIC_FLG	CL_SEQ_NO	P_CD	C	ESC	T_DESC	_DESC	HORT_DESC	AGE_VAL	SEX_CD	ESC	HORT_DESC	TN_CD	DESC	RR_1_CD	RR_2_CD	RR_3_CD	NT_1_CD	NT_2_CD	NT_3_CD	USE_1_CD	USE_2_CD	USE_3_CD	ASHES	WS	
		3718561	0	1	1	DRVR				INJC	42	2	OR-Y	OR<25	000		043										293	674
		3718562	0	1	1	DRVR				INJC	58	1	OR-Y	OR<25	000		000										293	674
		3720002	0	1	1	DRVR				NONE	17	2	OR-Y	OR<25	038		016	026									293	674
		3720003	0	1	1	DRVR				INJC	32	2	OR-Y	OR<25	000		000										293	674
		3662027	0	1	1	DRVR				NONE	00	9	UNK	UNK	000		000										293	674
		3662028	0	1	1	DRVR				NONE	00	9	UNK	UNK	000		000										293	674
		3620028	0	1	1	DRVR				INJB	16	1	OR-Y	OR<25	000		001	050									293	674
		3867813	0	1	1	DRVR				NONE	20	2	OR-Y	OR<25	038		016	043									293	674
		3867814	0	1	1	DRVR				INJC	29	2	OR-Y	OR<25	000		000										293	674
		3734094	0	1	1	DRVR				NONE	18	1	OR-Y	OR<25	000		029										293	674
		3734095	0	1	3	PED	STRGHT	N	S	INJC	19	1			035	I XWLK	000										293	674

4. BFR & Iowa

CRASH_ID	INT_ID	SER_NO	C	D_INVLV_FLG	VLV_FLG	LV_FLG	_FLG	E_IND	E_IND	FLG	UNLOCT	CRASH_DT	CRASH_WK	SHORT_DES	CNTY_NM	CITY_SECT_NM	NM	URB_AREA_SHORT_	HWY_NO	HWY_MED_NM	RDWY_NO	FC_CD	HWY_COM	T_SHORT_DE	MLGE_TY	RD_CON_	P_CD	NO	LRS	VAL
1751825	4	01176	CITY	0	0	0		0	0	N	FALSE	3/1/2017	4	4P	Washington	Tualatin	PORTLAND UA				16									
1751825	4	01176	CITY	0	0	0		0	0	N	FALSE	3/1/2017	4	4P	Washington	Tualatin	PORTLAND UA				16									
1800734	4	05219	CITY	0	0	0		0	0	N	FALSE	10/3/2018	4	5P	Washington	Tualatin	PORTLAND UA				16									
1800734	4	05219	CITY	0	0	0		0	0	N	FALSE	10/3/2018	4	5P	Washington	Tualatin	PORTLAND UA				16									
1802662	4	05820	CITY	0	0	0		0	0	N	FALSE	10/29/2018	2	3P	Washington	Tualatin	PORTLAND UA				16									
1802662	4	05820	CITY	0	0	0		0	0	N	FALSE	10/29/2018	2	3P	Washington	Tualatin	PORTLAND UA				16									
1737732	4	07245	CITY	0	0	0		0	0	N	FALSE	11/15/2017	4	5P	Washington	Tualatin	PORTLAND UA				16									
1737732	4	07245	CITY	0	0	0		0	0	N	FALSE	11/15/2017	4	5P	Washington	Tualatin	PORTLAND UA				16									
1799386	4	04797	CITY	0	0	0		0	0	N	FALSE	9/12/2018	4	6P	Washington	Tualatin	PORTLAND UA				16									
1799386	4	04797	CITY	0	0	0		0	0	N	FALSE	9/12/2018	4	6P	Washington	Tualatin	PORTLAND UA				16									
1799386	4	04797	CITY	0	0	0		0	0	N	FALSE	9/12/2018	4	6P	Washington	Tualatin	PORTLAND UA				16									

4. BFR & Iowa

MP_NO	ST_NO	ST_NM	ISECT_ST_		RD_CHAR_CD	RD_CHAR_S	CMPSS_DI	CMPSS_DIR			IMPCT_L	MEDN_TYP_		TRAF_CNTL_DE				WTHR_CON			LGT_COND_		COLLIS_TYP_		CRASH_SVR	
			NO	ISECT_ST_NM				R_CD	FROM_CD	SC		OC_CD	HORT_DESC	C	G_QTY	LN_QTY	ISECT_REL_FLG	VICE_SHORT_DE	OFF_RDW	RNDABT_F	DRVWY_R	D_SHORT_D	RD_SURF_S	SHORT_DES	CRASH_TYP_SH	SHORT_DES
00201	00201	SW BOONES FERRY RD	01104	SW IOWA DR	3	STRGHT	1		N	06		NONE		2	0	NONE	0	0	0	0	CLD	DRY	DAY	S-STRGHT	REAR	PDO
00201	00201	SW BOONES FERRY RD	01104	SW IOWA DR	3	STRGHT	1		N	06		NONE		2	0	NONE	0	0	0	0	CLD	DRY	DAY	S-STRGHT	REAR	PDO
00201	00201	SW BOONES FERRY RD	01104	SW IOWA DR	1	INTER	9		CN	01	CROSS		0	0	0	STOP SIGN	0	0	0	0	CLR	DRY	DAY	ANGL-OTH	TURN	INJ
00201	00201	SW BOONES FERRY RD	01104	SW IOWA DR	1	INTER	9		CN	01	CROSS		0	0	0	STOP SIGN	0	0	0	0	CLR	DRY	DAY	ANGL-OTH	TURN	INJ
00201	00201	SW BOONES FERRY RD	01104	SW IOWA DR	1	INTER	9		CN	03	CROSS		0	0	0	STOP SIGN	0	0	0	0	CLD	WET	DAY	ANGL-OTH	TURN	INJ
00201	00201	SW BOONES FERRY RD	01104	SW IOWA DR	1	INTER	9		CN	03	CROSS		0	0	0	STOP SIGN	0	0	0	0	CLD	WET	DAY	ANGL-OTH	TURN	INJ
00201	00201	SW BOONES FERRY RD	01104	SW IOWA DR	1	INTER	9		CN	04	CROSS		0	0	0	STOP SIGN	0	0	0	0	RAIN	WET	DLIT	BIKE	TURN	INJ
00201	00201	SW BOONES FERRY RD	01104	SW IOWA DR	1	INTER	9	5	CN	04	CROSS		0	0	0	STOP SIGN	0	0	0	0	RAIN	WET	DLIT	BIKE	TURN	INJ
00201	00201	SW BOONES FERRY RD	01104	SW IOWA DR	1	INTER	9		CN	04	CROSS		0	0	0	TRF SIGNAL	0	0	0	0	RAIN	WET	DAY	BIKE	TURN	INJ
00201	00201	SW BOONES FERRY RD	01104	SW IOWA DR	1	INTER	9		CN	04	CROSS		0	0	0	TRF SIGNAL	0	0	0	0	RAIN	WET	DAY	BIKE	TURN	INJ

4. BFR & Iowa

CRASH_EV			CRASH_CA			LAT			LONGTD			VHCL_COD			VHCL_OWNS			VHCL_MVMN			VHCL_CMPSS_D			VHCL_EVN			VHCL_CAU		
NT_1_CD	NT_2_CD	NT_3_CD	USE_1_CD	USE_2_CD	USE_3_CD	DEG NO	MINUTE NO	SEC NO	LAT	DEG NO	MINUTE NO	SEC NO	LONG	VHCL_ID	HCL_FLG	O	RT_DESC	HORT_DESC	Y	ESC	SC	T_DESC	DESC	TN_CD	T_1_CD	T_2_CD	T_3_CD	SE_1_CD	
			29			45	21	20.54	45.35570556	-122	46	29.14	-122.7747611	3304422	1	1	PSNGR CAR	NONE		9	N/A	STRGHT	N	S	000				00
			29			45	21	20.54	45.35570556	-122	46	29.14	-122.7747611	3304423	0	2	PSNGR CAR	NONE		9	N/A	STOP	N	S	011				00
			02			45	21	19.82	45.35550556	-122	46	29.16	-122.7747667	3394337	1	1	PSNGR CAR	NONE		0	PRVTE	TURN-L	E	S	000				00
			02			45	21	19.82	45.35550556	-122	46	29.16	-122.7747667	3394338	0	2	PSNGR CAR	NONE		0	PRVTE	TURN-L	N	E	000				00
			02	03		45	21	19.82	45.35550556	-122	46	29.16	-122.7747667	3397949	1	1	PSNGR CAR	NONE		0	PRVTE	STRGHT	N	S	000				00
			02	03		45	21	19.82	45.35550556	-122	46	29.16	-122.7747667	3397950	0	2	PSNGR CAR	NONE		0	PRVTE	TURN-L	W	N	000				00
			02			45	21	19.82	45.35550556	-122	46	29.16	-122.7747667	3278309	1	1	PSNGR CAR	NONE		0	PRVTE	TURN-R	S	E	000				00
			02			45	21	19.82	45.35550556	-122	46	29.16	-122.7747667		0														
			02			45	21	19.82	45.35550556	-122	46	29.14	-122.7747611	3391787	1	1	PSNGR CAR	NONE		0	PRVTE	TURN-L	N	E	000				00
			02			45	21	19.82	45.35550556	-122	46	29.14	-122.7747611	3391787	1	1	PSNGR CAR	NONE		0	PRVTE	TURN-L	N	E	000				00
			02			45	21	19.82	45.35550556	-122	46	29.14	-122.7747611		0														

4. BFR & Iowa

VHCL_CAU		STRIKG_P		PARTIC_VH	PARTIC_TY	SHORT_DES	NT_SHORT_D	DIR_FROM_SHOR	DIR_TO_SHORT	INJ_SVRTY_S	DRVR_LIC_ST		NON_MOTRST									TOTAL_CR	TOTAL_RO					
SE_2_CD	SE_3_CD	PARTIC_ID	ARTIC_FLG	CL_SEQ_NO	P_CD	C	ESC	T_DESC	_DESC	HORT_DESC	AGE_VAL	SEX_CD	ESC	HORT_DESC	TN_CD	DESC	RR_1_CD	RR_2_CD	RR_3_CD	NT_1_CD	NT_2_CD	NT_3_CD	USE_1_CD	USE_2_CD	USE_3_CD	ASHES	WS	
		3770151	0	1	1	DRVR				NONE	00	9	UNK	UNK	000		000										293	674
		3770152	0	1	1	DRVR				NONE	00	9	UNK	UNK	000		000										293	674
		3871724	0	1	1	DRVR				INJC	43	2	OR-Y	OR<25	000		028										293	674
		3871725	0	1	1	DRVR				INJA	39	2	OR-Y	OR<25	000		000										293	674
		3876296	0	1	1	DRVR				INJC	44	2	NONE	OR>25	000		000										293	674
		3876297	0	1	1	DRVR				NONE	16	1	OR-Y	OR<25	000		028	004	021						03		293	674
		3738958	0	1	1	DRVR				NONE	37	2	OR-Y	OR<25	000		027										293	674
		3738959	0	1	6	BIKE	STRGHT	S	N	INJB	62	1			035	I-BIKE LN	000										293	674
		3868514	0	1	1	DRVR				NONE	52	1	OR-Y	OR<25	000		027										293	674
		3868515	0	2	2	PSNG				NONE	02	2			000		000										293	674
		3868516	0	1	6	BIKE	STRGHT	S	N	INJB	27	1			000	I INRD	000										293	674

5. BFR & Norwood

CRASH_ID	INT_ID	SER_NO	INVTG_AGY				LANE RDWY				UNLOCT	CRASH_HR_			URB_AREA_SHORT_				HWY_COMPN							
			_SHORT_DES	CRASH_SPEE	ALCHL_IN	DRUG_INV	MJ_INVLV	SCHL_ZON	WRK_ZON	DPRT		CRASH	FLG	CRASH_DT	CRASH_WK	SHORT_DES	NM	HWY_NO	HWY_MED_NM	RDWY_NO	FC_CD	HWY_COM	T_SHORT_DE	MLGE_TY	RD_CON_	LRS
1823348	5	05839	NONE	0	0	0	0	0	0	N	FALSE	10/29/2018	2	3P	Washington	Tualatin	PORTLAND UA					16				
1823348	5	05839	NONE	0	0	0	0	0	0	N	FALSE	10/29/2018	2	3P	Washington	Tualatin	PORTLAND UA					16				
1704025	5	08636	NONE	0	0	0	0	0	0	N	FALSE	12/14/2016	4	6P	Washington	Tualatin	PORTLAND UA					16				
1704025	5	08636	NONE	0	0	0	0	0	0	N	FALSE	12/14/2016	4	6P	Washington	Tualatin	PORTLAND UA					16				
1748789	5	03180	CITY	1	0	0	0	0	0	N	FALSE	5/31/2017	4	3P	Washington	Tualatin	PORTLAND UA					16				
1696059	5	05132	CITY	1	0	0	0	0	0	N	FALSE	8/2/2016	3	12P	Washington	Tualatin	PORTLAND UA					16				
1696059	5	05132	CITY	1	0	0	0	0	0	N	FALSE	8/2/2016	3	12P	Washington	Tualatin	PORTLAND UA					16				
1618262	5	07146	CITY	0	0	0	0	0	0	N	FALSE	11/25/2015	4	2P	Washington	Tualatin	PORTLAND UA					16				
1618262	5	07146	CITY	0	0	0	0	0	0	N	FALSE	11/25/2015	4	2P	Washington	Tualatin	PORTLAND UA					16				
1618262	5	07146	CITY	0	0	0	0	0	0	N	FALSE	11/25/2015	4	2P	Washington	Tualatin	PORTLAND UA					16				

5. BFR & Norwood

MP_NO	ST_NO	ST_NM	ISECT_ST_		RD_CHAR_CD	RD_CHAR_S	CMPSS_DI	CMPSS_DIR			IMPCT_L	MEDN_TYP_		TURNG_LE	TRAF_CNTL_DE					WTHR_CON			LGT_COND_		COLLIS_TYP_		CRASH_SVR
			NO	ISECT_ST_NM				R_CD	FROM_CD	SC		OC_CD	HORT_DESC		C	G_QTY	LN_QTY	FLG	SC	Y_FLG	LG	EL_FLG	ESC	HORT_DESC	C	ORT_DESC	C
	00201	SW BOONES FERRY RD	01705	SW NORWOOD RD	3	STRGHT	1		N	08		NONE		2	0	UNKNOWN	0	0	0	0	CLD	WET	DAY	S-1STOP	REAR	PDO	
	00201	SW BOONES FERRY RD	01705	SW NORWOOD RD	3	STRGHT	1		N	08		NONE		2	0	UNKNOWN	0	0	0	0	CLD	WET	DAY	S-1STOP	REAR	PDO	
	00201	SW BOONES FERRY RD	01705	SW NORWOOD RD	1	INTER	3		E	05	3-LEG		0	0	0	STOP SIGN	0	0	0	0	SNOW	ICE	DLIT	O-OTHER	TURN	PDO	
	00201	SW BOONES FERRY RD	01705	SW NORWOOD RD	1	INTER	3		E	05	3-LEG		0	0	0	STOP SIGN	0	0	0	0	SNOW	ICE	DLIT	O-OTHER	TURN	PDO	
	00201	SW BOONES FERRY RD	01705	SW NORWOOD RD	1	INTER	3		E	05	3-LEG		0	0	0	STOP SIGN	1	0	0	0	CLD	DRY	DAY	FIX OBJ	FIX	PDO	
	00201	SW BOONES FERRY RD	01705	SW NORWOOD RD	1	INTER	3		E	06	3-LEG		0	0	0	STOP SIGN	0	0	0	0	CLR	DRY	DAY	ANGL-OTH	TURN	PDO	
	00201	SW BOONES FERRY RD	01705	SW NORWOOD RD	1	INTER	3		E	06	3-LEG		0	0	0	STOP SIGN	0	0	0	0	CLR	DRY	DAY	ANGL-OTH	TURN	PDO	
	00201	SW BOONES FERRY RD	01705	SW NORWOOD RD	1	INTER	9		CN	02	3-LEG		0	0	0	STOP SIGN	0	0	0	0	CLR	DRY	DAY	ANGL-OTH	TURN	INJ	
	00201	SW BOONES FERRY RD	01705	SW NORWOOD RD	1	INTER	9		CN	02	3-LEG		0	0	0	STOP SIGN	0	0	0	0	CLR	DRY	DAY	ANGL-OTH	TURN	INJ	
	00201	SW BOONES FERRY RD	01705	SW NORWOOD RD	1	INTER	9		CN	02	3-LEG		0	0	0	STOP SIGN	0	0	0	0	CLR	DRY	DAY	ANGL-OTH	TURN	INJ	

5. BFR & Norwood

CRASH_EV			CRASH_CA			LAT			LONGTD			VHCL_COD			VHCL_OWNS			VHCL_MVMN			VHCL_CMPSS_D			VHCL_EVN			VHCL_CAU	
NT_1_CD	NT_2_CD	NT_3_CD	USE_1_CD	USE_2_CD	USE_3_CD	DEG NO	MINUTE NO	SEC NO	DEG NO	MINUTE NO	SEC NO	LONG	VHCL_ID	HCL_FLG	ED_SEQ_N	RT_DESC	HORT_DESC	Y	ESC	SC	T_DESC	DESC	TN_CD	T_1_CD	T_2_CD	T_3_CD	SE_1_CD	
			29			45	21	14.61	45.35405833	-122	46	29.08	-122.7747444	3434113	1	1	PSNGR CAR	NONE	9	N/A	STRGHT	N	S	000				00
			29			45	21	14.61	45.35405833	-122	46	29.08	-122.7747444	3434114	0	2	PSNGR CAR	NONE	9	N/A	STOP	N	S	011				00
124			02			45	21	13.25	45.35368056	-122	46	29.07	-122.7747417	3215905	1	1	PSNGR CAR	NONE	9	N/A	TURN-L	N	E	000				00
124			02			45	21	13.25	45.35368056	-122	46	29.07	-122.7747417	3215906	0	2	TRUCK	NONE	9	N/A	TURN-R	S	E	000				00
053			01			45	21	13.25	45.35368056	-122	46	29.07	-122.7747417	3299165	1	1	PSNGR CAR	NONE	9	N/A	TURN-L	N	E	000				00
			08	30		45	21	13.25	45.35368056	-122	46	29.07	-122.7747417	3201528	1	1	PSNGR CAR	NONE	9	N/A	TURN-R	S	E	000				00
			08	30		45	21	13.25	45.35368056	-122	46	29.07	-122.7747417	3201529	0	2	SEMI TOW	NONE	9	N/A	STRGHT	E	W	006				00
083			02	40		45	21	13.25	45.35368056	-122	46	29.07	-122.7747417	3056593	1	1	PSNGR CAR	NONE	0	PRVTE	STRGHT	S	N	000				00
083			02	40		45	21	13.25	45.35368056	-122	46	29.07	-122.7747417	3056593	1	1	PSNGR CAR	NONE	0	PRVTE	STRGHT	S	N	000				00
083			02	40		45	21	13.25	45.35368056	-122	46	29.07	-122.7747417	3056594	0	2	PSNGR CAR	NONE	0	PRVTE	TURN-L	E	S	015				00

5. BFR & Norwood

VHCL_CAU		STRIKG_P		PARTIC_TYP	PARTIC_MVM	PARTIC_CMPSS_	PARTIC_CMPSS_	DRVR_LIC_ST				NON_MOTRST										TOTAL_CR	TOTAL_RO					
SE_2_CD	SE_3_CD	PARTIC_ID	ARTIC_FLG	CL_SEQ_NO	P_CD	C	ESC	T_DESC	_DESC	HORT_DESC	AGE_VAL	SEX_CD	ESC	HORT_DESC	TN_CD	DESC	RR_1_CD	RR_2_CD	RR_3_CD	NT_1_CD	NT_2_CD	NT_3_CD	USE_1_CD	USE_2_CD	USE_3_CD	ASHES	WS	
		3911832	0	1	1	DRVR				NONE	00	9	UNK	UNK	000		000										293	674
		3911833	0	1	1	DRVR				NONE	00	9	UNK	UNK	000		000										293	674
		3668550	0	1	1	DRVR				NONE	00	9	UNK	UNK	000		000										293	674
		3668551	0	1	1	DRVR				NONE	00	9	UNK	UNK	000		000										293	674
		3765029	0	1	1	DRVR				NONE	00	9	UNK	UNK	000		000										293	674
		3654516	0	1	1	DRVR				NONE	00	9	UNK	UNK	000		000										293	674
		3654517	0	1	1	DRVR				NONE	00	9	UNK	UNK	000		000										293	674
		3490131	0	1	1	DRVR				INJC	24	1	OR-Y	OR<25	000		000										293	674
		3490132	0	2	2	PSNG				INJC	21	2			000		000										293	674
		3490133	0	1	1	DRVR				INJC	29	2	OR-Y	OR<25	000		028			083			02	40			293	674

8. BFR & Day

INVSTG_AGY			LANE RDWY							CRASH_HR_				HWY_COMPN												
CRASH_ID	INT_ID	SER_NO	SHORT_DES	CRASH_SPEE	ALCHL_IN	DRUG_INV	MJ_INVLV	SCHL_ZON	WRK_ZON	DPRT	CRASH	UNLOCT	CRASH_DT	CRASH_WK	SHORT_DES	URB_AREA_SHORT_			RDWY_NO	FC_CD	HWY_COM	T_SHORT_DE	MLGE_TY	RD_CON_	LRS VAL	
			C	D_INVLV_FLG	VLV_FLG	LV_FLG	_FLG	E_IND	E_IND	FLG	FLG	FLG		DAY_CD	C	CNTY_NM	CITY_SECT_NM	NM	HWY_NO	HWY_MED_NM		PNT_CD	SC	P_CD	NO	
1826379	8	80420	COUNTY	0	0	0		0	0	N		FALSE	2/4/2019	2	5A	Washington	Wilsonville	PORTLAND UA								16
1819129	8	83471	NONE	0	0	0		0	0	N		FALSE	9/28/2018	6	4P	Washington	Wilsonville	PORTLAND UA								16
1819129	8	83471	NONE	0	0	0		0	0	N		FALSE	9/28/2018	6	4P	Washington	Wilsonville	PORTLAND UA								16
1872033	8	84151	NONE	0	0	0		0	0	N		FALSE	11/20/2019	4	1P	Washington	Wilsonville	PORTLAND UA								16
1872033	8	84151	NONE	0	0	0		0	0	N		FALSE	11/20/2019	4	1P	Washington	Wilsonville	PORTLAND UA								16
1633166	8	01858	NO RPT	0	0	0		0	0	N		FALSE	4/9/2015	5	3P	Washington	Wilsonville	PORTLAND UA								16
1633166	8	01858	NO RPT	0	0	0		0	0	N		FALSE	4/9/2015	5	3P	Washington	Wilsonville	PORTLAND UA								16
1633166	8	01858	NO RPT	0	0	0		0	0	N		FALSE	4/9/2015	5	3P	Washington	Wilsonville	PORTLAND UA								16
1676642	8	06703	COUNTY	0	0	0		0	0	N		FALSE	10/4/2016	3	4P	Washington	Wilsonville	PORTLAND UA	141	BEAVERTON-TUALATIN	1	16	0	MN	0	014100100S00
1676642	8	06703	COUNTY	0	0	0		0	0	N		FALSE	10/4/2016	3	4P	Washington	Wilsonville	PORTLAND UA	141	BEAVERTON-TUALATIN	1	16	0	MN	0	014100100S00
1676642	8	06703	COUNTY	0	0	0		0	0	N		FALSE	10/4/2016	3	4P	Washington	Wilsonville	PORTLAND UA	141	BEAVERTON-TUALATIN	1	16	0	MN	0	014100100S00
1790953	8	82897	NO RPT	0	0	0		0	0	N		FALSE	8/19/2018	1	6P	Washington	Wilsonville	PORTLAND UA								16
1790953	8	82897	NO RPT	0	0	0		0	0	N		FALSE	8/19/2018	1	6P	Washington	Wilsonville	PORTLAND UA								16
1750508	8	00405	NONE	0	0	0		0	0	N		FALSE	1/16/2017	2	UNK	Washington	Wilsonville	PORTLAND UA								16
1750508	8	00405	NONE	0	0	0		0	0	N		FALSE	1/16/2017	2	UNK	Washington	Wilsonville	PORTLAND UA								16
1749182	8	80200	NONE	0	0	0		0	0	N		FALSE	1/14/2017	7	10A	Washington	Wilsonville	PORTLAND UA								16
1749182	8	80200	NONE	0	0	0		0	0	N		FALSE	1/14/2017	7	10A	Washington	Wilsonville	PORTLAND UA								16
1839313	8	82007	CITY	0	0	0		0	0	N		FALSE	2/21/2019	5	5P	Washington	Wilsonville	PORTLAND UA								16
1839313	8	82007	CITY	0	0	0		0	0	N		FALSE	2/21/2019	5	5P	Washington	Wilsonville	PORTLAND UA								16
1857981	8	02987	NONE	0	0	0		0	0	N		FALSE	6/12/2019	4	5P	Washington	Wilsonville	PORTLAND UA								16
1857981	8	02987	NONE	0	0	0		0	0	N		FALSE	6/12/2019	4	5P	Washington	Wilsonville	PORTLAND UA								16
1765656	8	84789	NONE	0	0	0		0	0	N		FALSE	11/14/2017	3	9P	Washington	Wilsonville	PORTLAND UA								16
1765656	8	84789	NONE	0	0	0		0	0	N		FALSE	11/14/2017	3	9P	Washington	Wilsonville	PORTLAND UA								16
1795035	8	84103	NONE	0	0	0		0	0	N		FALSE	11/9/2018	6	4P	Washington	Wilsonville	PORTLAND UA								16
1795035	8	84103	NONE	0	0	0		0	0	N		FALSE	11/9/2018	6	4P	Washington	Wilsonville	PORTLAND UA								16
1795035	8	84103	NONE	0	0	0		0	0	N		FALSE	11/9/2018	6	4P	Washington	Wilsonville	PORTLAND UA								16

8. BFR & Day

MP_NO	ST_NO	ST_NM	ISECT_ST_		RD_CHAR_CD	RD_CHAR_S	CMPSS_DI	CMPSS_DIR			IMPCT_L	MEDN_TYP_		TURNQ_LE	TRAF_CNTL_DE				WTHR_CON			LGT_COND_		COLLIS_TYP_		CRASH_SVR
			NO	ISECT_ST_NM				R_CD	FROM_CD	SC		OC_CD	HORT_DESC		C	G_QTY	LN_QTY	ISECT_REL_FLG	VICE_SHORT_DE	OFF_RDW	RNDABT_F	DRVWY_R	D_SHORT_D	RD_SURF_S	SHORT_DES	
	00201	SW BEAV-TUALATIN HY	00601	SW DAY RD	1	INTER	3		E	05	3-LEG		0	0	0	TRF SIGNAL	1	0	0	RAIN	WET	DLIT	FIX OBJ	FIX	INJ	
	00201	SW BEAV-TUALATIN HY	00601	SW DAY RD	1	INTER	5		S	06	3-LEG		0	0	0	TRF SIGNAL	0	0	0	CLR	DRY	DAY	S-1STOP	SS-O	PDO	
	00201	SW BEAV-TUALATIN HY	00601	SW DAY RD	1	INTER	5		S	06	3-LEG		0	0	0	TRF SIGNAL	0	0	0	CLR	DRY	DAY	S-1STOP	SS-O	PDO	
	00201	SW BEAV-TUALATIN HY	00601	SW DAY RD	1	INTER	5		S	06	3-LEG		0	0	0	TRF SIGNAL	0	0	0	CLR	DRY	DAY	S-1STOP	REAR	PDO	
	00201	SW BEAV-TUALATIN HY	00601	SW DAY RD	1	INTER	5		S	06	3-LEG		0	0	0	TRF SIGNAL	0	0	0	CLR	DRY	DAY	S-1STOP	REAR	PDO	
	00201	SW BEAV-TUALATIN HY	00601	SW DAY RD	1	INTER	7		W	06	3-LEG		0	0	0	TRF SIGNAL	0	0	0	CLR	DRY	DAY	S-1STOP	REAR	PDO	
	00201	SW BEAV-TUALATIN HY	00601	SW DAY RD	1	INTER	7		W	06	3-LEG		0	0	0	TRF SIGNAL	0	0	0	CLR	DRY	DAY	S-1STOP	REAR	PDO	
	00201	SW BEAV-TUALATIN HY	00601	SW DAY RD	1	INTER	7		W	06	3-LEG		0	0	0	TRF SIGNAL	0	0	0	CLR	DRY	DAY	S-1STOP	REAR	PDO	
12.47	00201	SW BEAV-TUALATIN HY	00601	SW DAY RD	1	INTER	5		S	06	3-LEG		0	0	0	TRF SIGNAL	0	0	0	RAIN	WET	DAY	O-STRGHT	HEAD	INJ	
12.47	00201	SW BEAV-TUALATIN HY	00601	SW DAY RD	1	INTER	5		S	06	3-LEG		0	0	0	TRF SIGNAL	0	0	0	RAIN	WET	DAY	O-STRGHT	HEAD	INJ	
	00209	SW BOONES FERRY FR	00601	SW DAY RD	1	INTER	1		N	06	3-LEG		0	0	0	TRF SIGNAL	0	0	0	CLR	UNK	DAY	S-1STOP	REAR	INJ	
	00209	SW BOONES FERRY FR	00601	SW DAY RD	1	INTER	1		N	06	3-LEG		0	0	0	TRF SIGNAL	0	0	0	CLR	UNK	DAY	S-1STOP	REAR	INJ	
	00209	SW BOONES FERRY FR	00601	SW DAY RD	1	INTER	5		S	06	CROSS		0	0	0	TRF SIGNAL	0	0	0	SNOW	ICE	DAY	S-1STOP	REAR	PDO	
	00209	SW BOONES FERRY FR	00601	SW DAY RD	1	INTER	5		S	06	CROSS		0	0	0	TRF SIGNAL	0	0	0	SNOW	ICE	DAY	S-1STOP	REAR	PDO	
	00209	SW BOONES FERRY FR	00601	SW DAY RD	1	INTER	7		W	06	3-LEG		0	0	0	TRF SIGNAL	0	0	0	CLR	ICE	DAY	S-1STOP	REAR	PDO	
	00209	SW BOONES FERRY FR	00601	SW DAY RD	1	INTER	7		W	06	3-LEG		0	0	0	TRF SIGNAL	0	0	0	CLR	ICE	DAY	S-1STOP	REAR	PDO	
	00209	SW BOONES FERRY FR	00601	SW DAY RD	1	INTER	9		CN	03	CROSS		0	0	0	TRF SIGNAL	0	0	0	UNK	UNK	DUSK	ANGL-OTH	TURN	INJ	
	00209	SW BOONES FERRY FR	00601	SW DAY RD	1	INTER	9		CN	03	CROSS		0	0	0	TRF SIGNAL	0	0	0	UNK	UNK	DUSK	ANGL-OTH	TURN	INJ	
	00601	SW DAY RD	00209	SW BOONES FERRY FR	3	STRGHT	7		W	06		NONE		3	1	UNKNOWN	0	0	0	CLR	DRY	DAY	S-STRGHT	REAR	PDO	
	00601	SW DAY RD	00209	SW BOONES FERRY FR	3	STRGHT	7		W	06		NONE		3	1	UNKNOWN	0	0	0	CLR	DRY	DAY	S-STRGHT	REAR	PDO	
	00601	SW DAY RD	00209	SW BOONES FERRY FR	3	STRGHT	7		W	08		NONE		2	0	UNKNOWN	0	0	0	CLR	DRY	DLIT	S-1TURN	TURN	PDO	
	00601	SW DAY RD	00209	SW BOONES FERRY FR	3	STRGHT	7		W	08		NONE		2	0	UNKNOWN	0	0	0	CLR	DRY	DLIT	S-1TURN	TURN	PDO	
	00601	SW DAY RD	00209	SW BOONES FERRY FR	3	STRGHT	7		W	08		NONE		2	0	UNKNOWN	0	0	0	CLR	DRY	DUSK	S-1STOP	REAR	INJ	
	00601	SW DAY RD	00209	SW BOONES FERRY FR	3	STRGHT	7		W	08		NONE		2	0	UNKNOWN	0	0	0	CLR	DRY	DUSK	S-1STOP	REAR	INJ	
	00601	SW DAY RD	00209	SW BOONES FERRY FR	3	STRGHT	7		W	08		NONE		2	0	UNKNOWN	0	0	0	CLR	DRY	DUSK	S-1STOP	REAR	INJ	

8. BFR & Day

CRASH_EV			CRASH_CA			LAT			LONGTD			VHCL_COD			VHCL_OWNS			VHCL_MVMN			VHCL_CMPSS_D			VHCL_EVN			VHCL_CAU		
NT_1_CD	NT_2_CD	NT_3_CD	USE_1_CD	USE_2_CD	USE_3_CD	DEG	MINUTE	SEC	DEG	MINUTE	SEC	DEG	MINUTE	SEC	VHCL_ID	HCL_FLG	ED_SEQ_N	VHCL_TYP_SHO	VHCL_USE_S	TRLR_QT	HP_SHORT_D	T_SHORT_DE	IR_FROM_SHOR	IR_TO_SHORT_	TN_CD	T_1_CD	T_2_CD	T_3_CD	SE_1_CD
040	053	079	10			45	20	25.31	45.34036389	-122	46	24.9	-122.7735833	3439569	1	1	PSNGR CAR	NONE	0	PRVTE	STRGHT	W	E	000	040	053	079	00	
			10			45	20	25.31	45.34036389	-122	46	24.92	-122.7735889	3426617	1	1	PSNGR CAR	NONE	9	N/A	STRGHT	S	N	000				00	
			10			45	20	25.31	45.34036389	-122	46	24.92	-122.7735889	3426618	0	2	PSNGR CAR	NONE	9	N/A	STOP	S	N	011				00	
			29			45	20	25.3	45.34036111	-122	46	24.91	-122.7735861	3523959	1	1	PSNGR CAR	NONE	9	N/A	STRGHT	S	N	000				00	
			29			45	20	25.3	45.34036111	-122	46	24.91	-122.7735861	3523960	0	2	PSNGR CAR	NONE	9	N/A	STOP	S	N	011				00	
013			29			45	20	24.73	45.34020278	-122	46	24.67	-122.7735194	3084429	1	1	PSNGR CAR	NONE	0	PRVTE	STRGHT	W	E	000				00	
013			29			45	20	24.73	45.34020278	-122	46	24.67	-122.7735194	3084430	0	2	PSNGR CAR	NONE	0	PRVTE	STOP	W	E	011	013			00	
013			29			45	20	24.73	45.34020278	-122	46	24.67	-122.7735194	3084431	0	3	PSNGR CAR	NONE	0	PRVTE	STOP	W	E	022				00	
			26			45	20	24.73	45.34020278	-122	46	24.67	-122.7735194	3165521	1	1	PSNGR CAR	NONE	0	PRVTE	STRGHT	S	N	000				00	
			26			45	20	24.73	45.34020278	-122	46	24.67	-122.7735194	3165521	1	1	PSNGR CAR	NONE	0	PRVTE	STRGHT	S	N	000				00	
			26			45	20	24.73	45.34020278	-122	46	24.67	-122.7735194	3165522	0	2	PSNGR CAR	NONE	0	PRVTE	STRGHT	N	S	007				00	
			29			45	20	25.31	45.34036389	-122	46	24.9	-122.7735833	3375543	1	1	PSNGR CAR	NONE	0	PRVTE	STRGHT	N	S	000				00	
			29			45	20	25.31	45.34036389	-122	46	24.9	-122.7735833	3375544	0	2	PSNGR CAR	NONE	0	PRVTE	STOP	N	S	011				00	
124			29			45	20	25.3	45.34036111	-122	46	24.9	-122.7735833	3302153	1	1	PSNGR CAR	NONE	9	N/A	STRGHT	S	N	000				00	
124			29			45	20	25.3	45.34036111	-122	46	24.9	-122.7735833	3302154	0	2	PSNGR CAR	NONE	9	N/A	STOP	S	N	011				00	
			29			45	20	25.3	45.34036111	-122	46	24.9	-122.7735833	3299852	1	1	PSNGR CAR	NONE	9	N/A	STRGHT	W	E	000				00	
			29			45	20	25.3	45.34036111	-122	46	24.9	-122.7735833	3299853	0	2	PSNGR CAR	NONE	9	N/A	STOP	W	E	011				00	
			02			45	20	25.3	45.34036111	-122	46	24.92	-122.7735889	3464116	1	1	PSNGR CAR	NONE	0	UNKN	TURN-R	W	S	000				00	
			02			45	20	25.3	45.34036111	-122	46	24.92	-122.7735889	3464117	0	2	PSNGR CAR	NONE	0	PRVTE	STRGHT	N	S	000				00	
			29			45	20	25.3	45.34036111	-122	46	26.24	-122.7739556	3499035	1	1	PSNGR CAR	NONE	9	N/A	STRGHT	W	E	000				00	
			29			45	20	25.3	45.34036111	-122	46	26.24	-122.7739556	3499036	0	2	PSNGR CAR	NONE	9	N/A	STRGHT	W	E	006				00	
			08			45	20	25.29	45.34035833	-122	46	27.7	-122.7743611	3329101	1	1	PSNGR CAR	NONE	9	N/A	U-TURN	E	E	000				00	
			08			45	20	25.29	45.34035833	-122	46	27.7	-122.7743611	3329102	0	2	PSNGR CAR	NONE	9	N/A	STRGHT	E	W	000				00	
013			29			45	20	25.3	45.34036111	-122	46	26.51	-122.7740306	3383360	1	1	PSNGR CAR	NONE	0	PRVTE	STRGHT	W	E	000				00	
013			29			45	20	25.3	45.34036111	-122	46	26.51	-122.7740306	3383361	0	2	PSNGR CAR	NONE	0	PRVTE	STOP	W	E	011	013			00	
013			29			45	20	25.3	45.34036111	-122	46	26.51	-122.7740306	3383362	0	3	PSNGR CAR	NONE	0	PRVTE	STOP	W	E	022				00	

8. BFR & Day

VHCL_CAU		STRIKG_P		PARTIC_TYP	PARTIC_MVM	PARTIC_CMPSS_	PARTIC_CMPSS_	DRVR_LIC_ST			NON_MOTRST									TOTAL_CR	TOTAL_RO							
SE_2_CD	SE_3_CD	PARTIC_ID	ARTIC_FLG	CL_SEQ_NO	P_CD	C	SHORT_DES	NT_SHORT_D	DIR_FROM_SHOR	DIR_TO_SHORT	INJ_SVRTY_S	AT_SHORT_D	DRVR_RES_S	PARTIC_AC	_LOC_SHORT_	PARTIC_E	PARTIC_E	PARTIC_E	PARTIC_EV	PARTIC_EV	PARTIC_EV	PARTIC_CA	PARTIC_CA	PARTIC_CA	ASHES	WS		
		3917232	0	1	1	DRVR					INJA	42	1	OR-Y	OR<25	000									10	23	50	
		3904723	0	1	1	DRVR					NONE	00	9	UNK	UNK	000										00	23	50
		3904724	0	1	1	DRVR					NONE	00	9	UNK	UNK	000										00	23	50
		4010805	0	1	1	DRVR					NONE	00	9	UNK	UNK	000										00	23	50
		4010806	0	1	1	DRVR					NONE	00	9	UNK	UNK	000										00	23	50
		3523577	0	1	1	DRVR					NONE	18	2	OR-Y	OR<25	000										29	23	50
		3523578	0	1	1	DRVR					NONE	28	2	OR-Y	OR<25	000										00	23	50
		3523579	0	1	1	DRVR					NONE	41	2	OR-Y	UNK	000										00	23	50
		3614153	0	1	1	DRVR					INJC	55	1	OR-Y	OR<25	000										00	23	50
		3614154	0	2	2	PSNG					INJC	54	2			000										00	23	50
		3614155	0	1	1	DRVR					NONE	45	1	OR-Y	OR<25	000										26	23	50
		3848096	0	1	1	DRVR					NONE	18	1	OR-Y	OR<25	000										29	23	50
		3848097	0	1	1	DRVR					INJC	50	2	OR-Y	OR<25	000										00	23	50
		3767925	0	1	1	DRVR					NONE	00	9	UNK	UNK	000										00	23	50
		3767926	0	1	1	DRVR					NONE	00	9	UNK	UNK	000										00	23	50
		3765691	0	1	1	DRVR					NONE	00	9	UNK	UNK	000										00	23	50
		3765692	0	1	1	DRVR					NONE	00	9	UNK	UNK	000										00	23	50
		3946449	0	1	1	DRVR					NONE	22	2	UNK	UNK	000										02	23	50
		3946450	0	1	1	DRVR					INJC	19	1	OR-Y	OR>25	000										00	23	50
		3986700	0	1	1	DRVR					NONE	00	9	UNK	UNK	000										00	23	50
		3986701	0	1	1	DRVR					NONE	00	9	UNK	UNK	000										00	23	50
		3794285	0	1	1	DRVR					NONE	00	9	UNK	UNK	000										00	23	50
		3794286	0	1	1	DRVR					NONE	00	9	UNK	UNK	000										00	23	50
		3857845	0	1	1	DRVR					NONE	44	2	OR-Y	OR<25	000										29	23	50
		3857846	0	1	1	DRVR					NONE	24	1	OR-Y	OR<25	000										00	23	50
		3857847	0	1	1	DRVR					INJC	47	2	OR-Y	OR<25	000										00	23	50

9. BFR & 95th

CRASH_ID	INT_ID	SER_NO	INVTG_AGY				LANE RDWY				CRASH_HR_			URB_AREA_SHORT_				HWY_COMPN							
			_SHORT_DES	CRASH_SPEE	ALCHL_IN	DRUG_INV	MJ_INVLV	SCHL_ZON	WRK_ZON	DPRT	CRASH	UNLOCT	CRASH_DT	CRASH_WK	SHORT_DES	NM	HWY_NO	HWY_MED_NM	RDWY_NO	FC_CD	HWY_COM	T_SHORT_DE	MLGE_TY	RD_CON_	LRS
1707144	9	83541	NO RPT	0	0	0	0	0	0	N	FALSE	8/4/2016	5	3P	Washington	Wilsonville	PORTLAND UA			16					
1707144	9	83541	NO RPT	0	0	0	0	0	0	N	FALSE	8/4/2016	5	3P	Washington	Wilsonville	PORTLAND UA			16					
1782839	9	81492	NONE	0	0	0	0	0	0	N	FALSE	5/3/2018	5	4P	Washington	Wilsonville	PORTLAND UA	141	BEAVERTON-TUALATIN	1	16	0	MN	0	014100100S00
1782839	9	81492	NONE	0	0	0	0	0	0	N	FALSE	5/3/2018	5	4P	Washington	Wilsonville	PORTLAND UA	141	BEAVERTON-TUALATIN	1	16	0	MN	0	014100100S00
1751754	9	80913	STATE	0	0	0	0	0	0	N	FALSE	3/8/2017	4	4P	Washington	Wilsonville	PORTLAND UA	141	BEAVERTON-TUALATIN	1	16	0	MN	0	014100100S00
1751754	9	80913	STATE	0	0	0	0	0	0	N	FALSE	3/8/2017	4	4P	Washington	Wilsonville	PORTLAND UA	141	BEAVERTON-TUALATIN	1	16	0	MN	0	014100100S00
1651504	9	85729	NONE	0	0	0	0	0	0	N	FALSE	12/5/2015	7	10P	Washington	Wilsonville	PORTLAND UA			16					
1651504	9	85729	NONE	0	0	0	0	0	0	N	FALSE	12/5/2015	7	10P	Washington	Wilsonville	PORTLAND UA			16					
1875753	9	84631	CITY	0	1	0	0	0	0	Y	FALSE	12/21/2019	7	2A	Washington	Wilsonville	PORTLAND UA			16					

9. BFR & 95th

MP_NO	ST_NO	ST_NM	ISECT_ST_		RD_CHAR_CD	RD_CHAR_S	CMPSS_DI	CMPSS_DIR	SHORT_DE	IMPCT_L	MEDN_TYP_		TRAF_CNTL_DE				WTHR_CON			LGT_COND_		COLLIS_TYP_		CRASH_SVR			
			NO	ISECT_ST_NM							HORT_DESC	R_CD	FROM_CD	SC	OC_CD	HORT_DESC	C	G_QTY	LN_QTY	ISECT_REL_FLG	VICE_SHORT_DE	OFF_RDW	RNDABT_F		DRVWY_R	D_SHORT_D	RD_SURF_S
	00201	SW BEAV-TUALATIN HY	05095	SW 95TH AVE	1	INTER	7		W	06	3-LEG			1		0	TRF SIGNAL	0	0	0	0	CLR	DRY	DAY	S-1STOP	REAR	PDO
	00201	SW BEAV-TUALATIN HY	05095	SW 95TH AVE	1	INTER	7		W	06	3-LEG			1		0	TRF SIGNAL	0	0	0	0	CLR	DRY	DAY	S-1STOP	REAR	PDO
12.63	00201	SW BEAV-TUALATIN HY	05095	SW 95TH AVE	1	INTER	1		N	06	3-LEG			1		0	TRF SIGNAL	0	0	0	0	CLR	DRY	DAY	S-1STOP	REAR	INJ
12.63	00201	SW BEAV-TUALATIN HY	05095	SW 95TH AVE	1	INTER	1		N	06	3-LEG			1		0	TRF SIGNAL	0	0	0	0	CLR	DRY	DAY	S-1STOP	REAR	INJ
12.63	00201	SW BEAV-TUALATIN HY	05095	SW 95TH AVE	1	INTER	9		CN	01	3-LEG			1		0	TRF SIGNAL	0	0	0	0	RAIN	WET	DAY	O-1 L-TURN	TURN	PDO
12.63	00201	SW BEAV-TUALATIN HY	05095	SW 95TH AVE	1	INTER	9		CN	01	3-LEG			1		0	TRF SIGNAL	0	0	0	0	RAIN	WET	DAY	O-1 L-TURN	TURN	PDO
	00401	SW COMMERCE CIR	05095	SW 95TH AVE	1	INTER	5		S	06	3-LEG			1		0	STOP SIGN	0	0	0	0	CLR	WET	DLIT	S-1STOP	REAR	PDO
	00401	SW COMMERCE CIR	05095	SW 95TH AVE	1	INTER	5		S	06	3-LEG			1		0	STOP SIGN	0	0	0	0	CLR	WET	DLIT	S-1STOP	REAR	PDO
	05095	SW 95TH AVE	00401	SW COMMERCE CIR	5	CURVE	5		S	07		NONE		4		0	NONE	1	0	0	0	RAIN	WET	DLIT	FIX OBJ	FIX	PDO

9. BFR & 95th

CRASH_EV			CRASH_CA			LAT			LONGTD				VHCL_COD				VHCL_OWNS				VHCL_MVMN				VHCL_CMPSS_D				VHCL_EVN				VHCL_CAU
NT_1_CD	NT_2_CD	NT_3_CD	USE_1_CD	USE_2_CD	USE_3_CD	DEG NO	MINUTE NO	SEC NO	LAT	DEG NO	MINUTE NO	SEC NO	LONG	VHCL_ID	HCL_FLG	O	RT_DESC	HORT_DESC	Y	ESC	SC	T_DESC	DESC	TN_CD	T_1_CD	T_2_CD	T_3_CD	SE_1_CD					
			27	29		45	20	16.41	45.33789167	-122	46	21.63	-122.772675	3221580	1	1	PSNGR CAR	NONE		9	N/A	STRGHT	W	E	000				00				
			27	29		45	20	16.41	45.33789167	-122	46	21.63	-122.772675	3221581	0	2	PSNGR CAR	NONE		9	N/A	STOP	W	E	011				00				
			29			45	20	16.42	45.33789444	-122	46	21.64	-122.7726778	3360120	1	1	PSNGR CAR	NONE		0	PRVTE	STRGHT	N	S	000				00				
			29			45	20	16.42	45.33789444	-122	46	21.64	-122.7726778	3360121	0	2	PSNGR CAR	NONE		0	PRVTE	STOP	N	S	011				00				
			02			45	20	16.64	45.33795556	-122	46	21.77	-122.7727139	3304293	1	1	PSNGR CAR	NONE		9	N/A	TURN-L	S	W	000				00				
			02			45	20	16.64	45.33795556	-122	46	21.77	-122.7727139	3304294	0	2	PSNGR CAR	NONE		9	N/A	STRGHT	N	S	000				00				
			29			45	20	15.55	45.33765278	-122	46	23.78	-122.7732722	3118254	1	1	PSNGR CAR	NONE		0	PRVTE	STRGHT	S	N	000				00				
			29			45	20	15.55	45.33765278	-122	46	23.78	-122.7732722	3118255	0	2	PSNGR CAR	NONE		0	PRVTE	STOP	S	N	011				00				
040			10			45	20	15	45.3375	-122	46	24.07	-122.7733528	3530174	1	1	PSNGR CAR	NONE		9	N/A	STRGHT	N	S	000				00				

9. BFR & 95th

VHCL_CAU		STRIKG_P		PARTIC_VH	PARTIC_TY	SHORT_DES	NT_SHORT_D	DIR_FROM_SHOR	DIR_TO_SHORT	INJ_SVRTY_S	DRVR_LIC_ST		NON_MOTRST									TOTAL_CR	TOTAL_RO				
SE_2_CD	SE_3_CD	PARTIC_ID	ARTIC_FLG	CL_SEQ_NO	P_CD	C	ESC	T_DESC	_DESC	HORT_DESC	AGE_VAL	SEX_CD	ESC	HORT_DESC	TN_CD	DESC	RR_1_CD	RR_2_CD	RR_3_CD	NT_1_CD	NT_2_CD	NT_3_CD	USE_1_CD	USE_2_CD	USE_3_CD	ASHES	WS
		3674057	0	1	1	DRVR				NONE	00	9	UNK	UNK	000		000						00			28	54
		3674058	0	1	1	DRVR				NONE	00	9	UNK	UNK	000		000						00			28	54
		3828637	0	1	1	DRVR				NONE	35	2	OR-Y	OR<25	000		026						29			28	54
		3828638	0	1	1	DRVR				INJC	19	1	OR-Y	OR<25	000		000						00			28	54
		3770027	0	1	1	DRVR				NONE	00	9	UNK	UNK	000		000						00			28	54
		3770028	0	1	1	DRVR				NONE	00	9	UNK	UNK	000		000						00			28	54
		3557115	0	1	1	DRVR				NONE	20	2	OR-Y	OR<25	000		026						29			28	54
		3557116	0	1	1	DRVR				NONE	00	1	UNK	UNK	000		000						00			28	54
		4016835	0	1	1	DRVR				NONE	00	9	UNK	UNK	000		000						00			28	54

10. I-5 SB Ramps & BFR

CRASH_ID	INT_ID	SER_NO	INVTG_AGY				LANE RDWY						CRASH_HR				HWY_COMPN									
			SHORT_DES	CRASH_SPEE	ALCHL_IN	DRUG_INV	MJ_INVLV	SCHL_ZON	WRK_ZON	DPRT	CRASH	UNLOCT	CRASH_DT	CRASH_WK	SHORT_DES	URB_AREA_SHORT	HWY_COM	T_SHORT_DE	MLGE_TY	RD_CON	LR VAL					
			C	D_INVLV_FLG	VLV_FLG	LV_FLG	FLG	E_IND	E_IND	FLG	FLG	FLG	FLG	CNTY_NM	CITY_SECT_NM	URB_AREA_SHORT	HWY_NO	HWY_MED_NM	RDWY_NO	FC_CD	PNT_CD	SC	P_CD	NO	LR VAL	
1632481	10	01360	NONE	0	0	0	0	0	0	N	FALSE	2/17/2015	3	9A	Washington	Wilsonville	PORTLAND UA	141	BEAVERTON-TUALATIN	2	16	0	MN	0	014100200S00	
1632481	10	01360	NONE	0	0	0	0	0	0	N	FALSE	2/17/2015	3	9A	Washington	Wilsonville	PORTLAND UA	141	BEAVERTON-TUALATIN	2	16	0	MN	0	014100200S00	
1699409	10	82258	NONE	0	0	0	0	0	0	N	FALSE	5/13/2016	6	5P	Washington	Wilsonville	PORTLAND UA	141	BEAVERTON-TUALATIN	2	16	0	MN	0	014100200S00	
1699409	10	82258	NONE	0	0	0	0	0	0	N	FALSE	5/13/2016	6	5P	Washington	Wilsonville	PORTLAND UA	141	BEAVERTON-TUALATIN	2	16	0	MN	0	014100200S00	
1704885	10	83435	NONE	0	0	0	0	0	0	N	FALSE	7/28/2016	5	5P	Washington	Wilsonville	PORTLAND UA	141	BEAVERTON-TUALATIN	2	16	0	MN	0	014100200S00	
1704885	10	83435	NONE	0	0	0	0	0	0	N	FALSE	7/28/2016	5	5P	Washington	Wilsonville	PORTLAND UA	141	BEAVERTON-TUALATIN	2	16	0	MN	0	014100200S00	
1612188	10	04248	NONE	0	0	0	0	0	0	N	FALSE	7/28/2015	3	11A	Washington	Wilsonville	PORTLAND UA	141	BEAVERTON-TUALATIN	2	16	0	MN	0	014100200S00	
1612188	10	04248	NONE	0	0	0	0	0	0	N	FALSE	7/28/2015	3	11A	Washington	Wilsonville	PORTLAND UA	141	BEAVERTON-TUALATIN	2	16	0	MN	0	014100200S00	
1632453	10	80403	COUNTY	0	0	0	0	0	0	N	FALSE	2/1/2015	1	12P	Washington	Wilsonville	PORTLAND UA	141	BEAVERTON-TUALATIN	2	16	0	MN	0	014100200S00	
1632453	10	80403	COUNTY	0	0	0	0	0	0	N	FALSE	2/1/2015	1	12P	Washington	Wilsonville	PORTLAND UA	141	BEAVERTON-TUALATIN	2	16	0	MN	0	014100200S00	
1649015	10	83738	NONE	0	0	0	0	0	0	N	FALSE	9/12/2015	7	1P	Washington	Wilsonville	PORTLAND UA	141	BEAVERTON-TUALATIN	2	11	0	MN	0	014100200S00	
1649015	10	83738	NONE	0	0	0	0	0	0	N	FALSE	9/12/2015	7	1P	Washington	Wilsonville	PORTLAND UA	141	BEAVERTON-TUALATIN	2	11	0	MN	0	014100200S00	
1687096	10	86048	NONE	0	0	0	0	0	0	N	FALSE	12/26/2016	2	1P	Washington	Wilsonville	PORTLAND UA	141	BEAVERTON-TUALATIN	2	16	0	MN	0	014100200S00	
1687096	10	86048	NONE	0	0	0	0	0	0	N	FALSE	12/26/2016	2	1P	Washington	Wilsonville	PORTLAND UA	141	BEAVERTON-TUALATIN	2	16	0	MN	0	014100200S00	
1687096	10	86048	NONE	0	0	0	0	0	0	N	FALSE	12/26/2016	2	1P	Washington	Wilsonville	PORTLAND UA	141	BEAVERTON-TUALATIN	2	16	0	MN	0	014100200S00	
1687096	10	86048	NONE	0	0	0	0	0	0	N	FALSE	12/26/2016	2	1P	Washington	Wilsonville	PORTLAND UA	141	BEAVERTON-TUALATIN	2	16	0	MN	0	014100200S00	
1699410	10	82366	NONE	0	0	0	0	0	0	N	FALSE	5/3/2016	3	11A	Washington	Wilsonville	PORTLAND UA	141	BEAVERTON-TUALATIN	2	16	0	MN	0	014100200S00	
1699410	10	82366	NONE	0	0	0	0	0	0	N	FALSE	5/3/2016	3	11A	Washington	Wilsonville	PORTLAND UA	141	BEAVERTON-TUALATIN	2	16	0	MN	0	014100200S00	
1704530	10	93229	STATE	0	0	0	0	0	0	N	FALSE	7/17/2016	1	5P	Washington	Wilsonville	PORTLAND UA	141	BEAVERTON-TUALATIN	2	16	0	MN	0	014100200S00	
1704530	10	93229	STATE	0	0	0	0	0	0	N	FALSE	7/17/2016	1	5P	Washington	Wilsonville	PORTLAND UA	141	BEAVERTON-TUALATIN	2	16	0	MN	0	014100200S00	
1753150	10	81289	NONE	0	0	0	0	0	0	N	FALSE	4/6/2017	5	1P	Washington	Wilsonville	PORTLAND UA	141	BEAVERTON-TUALATIN	2	16	0	MN	0	014100200S00	
1753150	10	81289	NONE	0	0	0	0	0	0	N	FALSE	4/6/2017	5	1P	Washington	Wilsonville	PORTLAND UA	141	BEAVERTON-TUALATIN	2	16	0	MN	0	014100200S00	
1781967	10	81337	COUNTY	0	0	0	0	0	0	N	FALSE	4/21/2018	7	9A	Washington	Wilsonville	PORTLAND UA	141	BEAVERTON-TUALATIN	2	16	0	MN	0	014100200S00	
1781967	10	81337	COUNTY	0	0	0	0	0	0	N	FALSE	4/21/2018	7	9A	Washington	Wilsonville	PORTLAND UA	141	BEAVERTON-TUALATIN	2	16	0	MN	0	014100200S00	
1723717	10	82086	NO RPT	0	0	0	0	0	0	N	FALSE	5/28/2017	1	12P	Washington	Wilsonville	PORTLAND UA	141	BEAVERTON-TUALATIN	2	16	0	MN	0	014100200S00	
1723717	10	82086	NO RPT	0	0	0	0	0	0	N	FALSE	5/28/2017	1	12P	Washington	Wilsonville	PORTLAND UA	141	BEAVERTON-TUALATIN	2	16	0	MN	0	014100200S00	
1612720	10	04541	NONE	0	0	0	0	0	0	N	FALSE	8/10/2015	2	7P	Washington	Wilsonville	PORTLAND UA	001	PACIFIC	1	11	6	CN	0	1	0001RH100S00
1612720	10	04541	NONE	0	0	0	0	0	0	N	FALSE	8/10/2015	2	7P	Washington	Wilsonville	PORTLAND UA	001	PACIFIC	1	11	6	CN	0	1	0001RH100S00
1630443	10	80033	NONE	0	0	0	0	0	0	N	FALSE	1/4/2015	1	1P	Washington	Wilsonville	PORTLAND UA	001	PACIFIC	1	11	6	CN	0	1	0001RH100S00
1630443	10	80033	NONE	0	0	0	0	0	0	N	FALSE	1/4/2015	1	1P	Washington	Wilsonville	PORTLAND UA	001	PACIFIC	1	11	6	CN	0	1	0001RH100S00
1631865	10	00966	NONE	0	0	0	0	0	0	N	FALSE	2/17/2015	3	11A	Washington	Wilsonville	PORTLAND UA	001	PACIFIC	1	11	6	CN	0	1	0001RH100S00
1631865	10	00966	NONE	0	0	0	0	0	0	N	FALSE	2/17/2015	3	11A	Washington	Wilsonville	PORTLAND UA	001	PACIFIC	1	11	6	CN	0	1	0001RH100S00
1753557	10	02060	NONE	0	0	0	0	0	0	N	FALSE	4/11/2017	3	2P	Washington	Wilsonville	PORTLAND UA	001	PACIFIC	1	11	6	CN	0	1	0001RH100S00
1753557	10	02060	NONE	0	0	0	0	0	0	N	FALSE	4/11/2017	3	2P	Washington	Wilsonville	PORTLAND UA	001	PACIFIC	1	11	6	CN	0	1	0001RH100S00
1853575	10	83309	NONE	0	0	0	0	0	0	N	FALSE	9/25/2019	4	5P	Washington	Wilsonville	PORTLAND UA	001	PACIFIC	1	11	6	CN	0	1	0001RH100S00
1853575	10	83309	NONE	0	0	0	0	0	0	N	FALSE	9/25/2019	4	5P	Washington	Wilsonville	PORTLAND UA	001	PACIFIC	1	11	6	CN	0	1	0001RH100S00
1626094	10	84469	STATE	0	0	0	0	0	0	N	FALSE	10/29/2015	5	6A	Washington	Wilsonville	PORTLAND UA	001	PACIFIC	1	11	6	CN	0	1	0001RH100S00
1626094	10	84469	STATE	0	0	0	0	0	0	N	FALSE	10/29/2015	5	6A	Washington	Wilsonville	PORTLAND UA	001	PACIFIC	1	11	6	CN	0	1	0001RH100S00
1651205	10	84886	NONE	0	0	0	0	0	0	N	FALSE	11/18/2015	4	3P	Washington	Wilsonville	PORTLAND UA	001	PACIFIC	1	11	6	CN	0	1	0001RH100S00
1651205	10	84886	NONE	0	0	0	0	0	0	N	FALSE	11/18/2015	4	3P	Washington	Wilsonville	PORTLAND UA	001	PACIFIC	1	11	6	CN	0	1	0001RH100S00
1687203	10	86095	NONE	0	0	0	0	0	0	N	FALSE	12/26/2016	2	1P	Washington	Wilsonville	PORTLAND UA	001	PACIFIC	1	11	6	CN	0	1	0001RH100S00
1687203	10	86095	NONE	0	0	0	0	0	0	N	FALSE	12/26/2016	2	1P	Washington	Wilsonville	PORTLAND UA	001	PACIFIC	1	11	6	CN	0	1	0001RH100S00
1687203	10	86095	NONE	0	0	0	0	0	0	N	FALSE	12/26/2016	2	1P	Washington	Wilsonville	PORTLAND UA	001	PACIFIC	1	11	6	CN	0	1	0001RH100S00
1693176	10	03235	NONE	0	0	0	0	0	0	N	FALSE	5/17/2016	3	6P	Washington	Wilsonville	PORTLAND UA	001	PACIFIC	1	11	6	CN	0	1	0001RH100S00
1693176	10	03235	NONE	0	0	0	0	0	0	N	FALSE	5/17/2016	3	6P	Washington	Wilsonville	PORTLAND UA	001	PACIFIC	1	11	6	CN	0	1	0001RH100S00
1758535	10	04726	NONE	0	0	0	0	0	0	N	FALSE	8/2/2017	4	12P	Washington	Wilsonville	PORTLAND UA	001	PACIFIC	1	11	6	CN	0	1	0001RH100S00
1758535	10	04726	NONE	0	0	0	0	0	0	N	FALSE	8/2/2017	4	12P	Washington	Wilsonville	PORTLAND UA	001	PACIFIC	1	11	6	CN	0	1	0001RH100S00
1845329	10	81925	NO RPT	0	0	0	0	0	0	N	FALSE	6/1/2019	7	4P	Washington	Wilsonville	PORTLAND UA	001	PACIFIC	1	11	6	CN	0	1	0001RH100S00
1845329	10	81925	NO RPT	0	0	0	0	0	0	N	FALSE	6/1/2019	7	4P	Washington	Wilsonville	PORTLAND UA	001	PACIFIC	1	11	6	CN	0	1	0001RH100S00
1845329	10	81925	NO RPT	0	0	0	0	0	0	N	FALSE	6/1/2019	7	4P	Washington	Wilsonville	PORTLAND UA	001	PACIFIC	1	11	6	CN	0	1	0001RH100S00
1694438	10	04109	NONE	0	0	0	0	0	0	N	FALSE	6/6/2016	2	2P	Washington	Wilsonville	PORTLAND UA	001	PACIFIC	1	11	6	CN	0	1	0001RH100S00
1694438	10	04109	NONE	0	0	0	0	0	0	N	FALSE	6/6/2016	2	2P	Washington	Wilsonville	PORTLAND UA	001	PACIFIC	1	11	6	CN	0	1	0001RH100S00
1704886	10	83437	NONE	0	0	0	0	0	0	N	FALSE	7/28/2016	5	6P	Washington	Wilsonville	PORTLAND UA	001	PACIFIC	1	11	6	CN	0	1	0001RH100S00
1704886	10	83437	NONE	0	0	0	0	0	0	N	FALSE	7/28/2016	5	6P	Washington	Wilsonville	PORTLAND UA	001	PACIFIC	1	11	6	CN	0	1	0001RH100S00
1725344	10	83381	NONE	0	0	0	0	0	0	N	FALSE	8/17/2017	5	10A	Washington	Wilsonville	PORTLAND UA	001	PACIFIC	1	11	6	CN	0	1	0001RH100S00
1725344	10	83381	NONE	0	0	0	0	0	0	N	FALSE	8/17/2017	5	10A	Washington	Wilsonville	PORTLAND UA	001	PACIFIC	1	11	6	CN	0	1	0001RH100S00
1836587	10	82232	STATE	0	0	0	0	0	0	N	FALSE	7/2/2019	3	9A	Washington	Wilsonville	PORTLAND UA	001	PACIFIC	1	11	6	CN	0	1	0001RH100S00
1836587	10	82232	STATE	0	0	0	0	0	0	N	FALSE	7/2/2019	3	9A	Washington	Wilsonville	PORTLAND UA	001	PACIFIC	1	11	6	CN	0		

10. I-5 SB Ramps & BFR

CRASH_ID	INT_ID	SER_NO	INVSTG_AGY		ALCHL_IN	DRUG_INV	MJ_INVLV	SCHL_ZON	WRK_ZON	LANE RDWY		UNLOCT	CRASH_HR_		CNTY_NM	CITY_SECT_NM	URB_AREA_SHORT_	HWY_NO	HWY_MED_NM	RDWY_NO	FC_CD	HWY_COMPN		MLGE_TY	RD_CON_	LRS_VAL
			_SHORT_DES	C						D_INVLV_FLG	VLV_FLG		LV_FLG	_FLG								E_IND	E_IND			
1718531	10	00901	STATE	0	0	0	0	0	0	N	FALSE	2/16/2017	5	7A	Washington	Wilsonville	PORTLAND UA	001	PACIFIC	1	11	6	CN	0	1	0001RH100S00
1718531	10	00901	STATE	0	0	0	0	0	0	N	FALSE	2/16/2017	5	7A	Washington	Wilsonville	PORTLAND UA	001	PACIFIC	1	11	6	CN	0	1	0001RH100S00
1712831	10	85441	STATE	0	0	0	0	0	0	N	FALSE	11/23/2016	4	5P	Washington	Wilsonville	PORTLAND UA	001	PACIFIC	1	11	6	CN	0	1	0001RH100S00
1712831	10	85441	STATE	0	0	0	0	0	0	N	FALSE	11/23/2016	4	5P	Washington	Wilsonville	PORTLAND UA	001	PACIFIC	1	11	6	CN	0	1	0001RH100S00
1723806	10	81813	NONE	0	0	0	0	0	0	N	FALSE	5/10/2017	4	5P	Washington	Wilsonville	PORTLAND UA	001	PACIFIC	1	11	6	CN	0	1	0001RH100S00
1723806	10	81813	NONE	0	0	0	0	0	0	N	FALSE	5/10/2017	4	5P	Washington	Wilsonville	PORTLAND UA	001	PACIFIC	1	11	6	CN	0	1	0001RH100S00
1726389	10	84900	NONE	0	0	0	0	0	0	N	FALSE	11/20/2017	2	6A	Washington	Wilsonville	PORTLAND UA	001	PACIFIC	1	11	6	CN	0	1	0001RH100S00
1726389	10	84900	NONE	0	0	0	0	0	0	N	FALSE	11/20/2017	2	6A	Washington	Wilsonville	PORTLAND UA	001	PACIFIC	1	11	6	CN	0	1	0001RH100S00
1604708	10	00738	NONE	0	0	0	0	0	0	N	FALSE	2/9/2015	2	8P	Washington	Wilsonville	PORTLAND UA	001	PACIFIC	1	11	6	CN	0	1	0001RH100S00
1604708	10	00738	NONE	0	0	0	0	0	0	N	FALSE	2/9/2015	2	8P	Washington	Wilsonville	PORTLAND UA	001	PACIFIC	1	11	6	CN	0	1	0001RH100S00
1725342	10	83199	NONE	0	0	0	0	0	0	N	FALSE	8/5/2017	7	2P	Washington	Wilsonville	PORTLAND UA	001	PACIFIC	1	11	6	CN	0	1	0001RH100S00
1725342	10	83199	NONE	0	0	0	0	0	0	N	FALSE	8/5/2017	7	2P	Washington	Wilsonville	PORTLAND UA	001	PACIFIC	1	11	6	CN	0	1	0001RH100S00
1721473	10	84379	NO RPT	0	0	0	0	0	0	N	FALSE	8/19/2017	7	9A	Washington	Wilsonville	PORTLAND UA	001	PACIFIC	1	11	6	CN	0	1	0001RH100S00
1721473	10	84379	NO RPT	0	0	0	0	0	0	N	FALSE	8/19/2017	7	9A	Washington	Wilsonville	PORTLAND UA	001	PACIFIC	1	11	6	CN	0	1	0001RH100S00

10. I-5 SB Ramps & BFR

MP_NO	ST_NO	ST_NM	ISECT_ST_		RD_CHAR_CD	RD_CHAR_S	CMPSS_DI	CMPSS_DIR			IMPCT_L	MEDN_TYP_			TRAF_CNTL_DE				WTHR_CON			LGT_COND_		COLLIS_TYP_		CRASH_SVR
			NO	ISECT_ST_NM				R_CD	FROM_CD	SC		OC_CD	HORT_DESC	C	G_QTY	LN_QTY	FLG	SC	Y_FLG	LG	EL_FLG	ESC	HORT_DESC	C	ORT_DESC	C
286.66	09501	SB EX BEAV-TUAL C1	00201	SW BEAV-TUALATIN HY	7	GRADE	2		NE	04		DIVMD			3	0	TRF SIGNAL	0	0	0	RAIN	WET	DAY	S-STRGHT	REAR	INJ
286.66	09501	SB EX BEAV-TUAL C1	00201	SW BEAV-TUALATIN HY	7	GRADE	2		NE	04		DIVMD			3	0	TRF SIGNAL	0	0	0	RAIN	WET	DAY	S-STRGHT	REAR	INJ
286.69	09501	SB EX BEAV-TUAL C1	00201	SW BEAV-TUALATIN HY	7	GRADE	2		NE	04		NONE			3	0	UNKNOWN	0	0	0	RAIN	WET	DUSK	S-STRGHT	REAR	PDO
286.69	09501	SB EX BEAV-TUAL C1	00201	SW BEAV-TUALATIN HY	7	GRADE	2		NE	04		NONE			3	0	UNKNOWN	0	0	0	RAIN	WET	DUSK	S-STRGHT	REAR	PDO
286.69	09501	SB EX BEAV-TUAL C1	00201	SW BEAV-TUALATIN HY	3	STRGHT	2		NE	04		NONE			2	0	UNKNOWN	0	0	0	CLR	DRY	DAY	S-1STOP	REAR	PDO
286.7	09501	SB EX BEAV-TUAL C1	00201	SW BEAV-TUALATIN HY	3	STRGHT	2		NE	04		NONE			2	0	UNKNOWN	0	0	0	RAIN	WET	DARK	S-1STOP	REAR	PDO
286.7	09501	SB EX BEAV-TUAL C1	00201	SW BEAV-TUALATIN HY	3	STRGHT	2		NE	04		NONE			2	0	UNKNOWN	0	0	0	RAIN	WET	DARK	S-1STOP	REAR	PDO
286.7	09501	SB EX BEAV-TUAL C1	00201	SW BEAV-TUALATIN HY	3	STRGHT	2		NE	05		NONE			6	0	TRF SIGNAL	0	0	0	RAIN	WET	DLIT	S-1STOP	REAR	INJ
286.7	09501	SB EX BEAV-TUAL C1	00201	SW BEAV-TUALATIN HY	3	STRGHT	2		NE	05		NONE			6	0	TRF SIGNAL	0	0	0	RAIN	WET	DLIT	S-1STOP	REAR	INJ
286.72	09501	SB EX BEAV-TUAL C1	00201	SW BEAV-TUALATIN HY	1	INTER	1		N	09	CROSS			2	0	TRF SIGNAL	0	0	0	UNK	UNK	DAY	S-1STOP	REAR	PDO	
286.72	09501	SB EX BEAV-TUAL C1	00201	SW BEAV-TUALATIN HY	1	INTER	1		N	09	CROSS			2	0	TRF SIGNAL	0	0	0	UNK	UNK	DAY	S-1STOP	REAR	PDO	
286.72	09501	SB EX BEAV-TUAL C1	00201	SW BEAV-TUALATIN HY	1	INTER	2		NE	06	3-LEG			2	0	TRF SIGNAL	0	0	0	CLR	DRY	DAY	S-1STOP	REAR	INJ	
286.72	09501	SB EX BEAV-TUAL C1	00201	SW BEAV-TUALATIN HY	1	INTER	2		NE	06	3-LEG			2	0	TRF SIGNAL	0	0	0	CLR	DRY	DAY	S-1STOP	REAR	INJ	

10. I-5 SB Ramps & BFR

CRASH_EV	CRASH_EV	CRASH_EV	CRASH_CA	CRASH_CA	CRASH_CA	LAT DEG	LAT MINUTE	LAT SEC	LONGTD DEG	LONGTD MINUTE	LONGTD SEC	LONG	VHCL_ID	VHCL_COD	ED_SEQ_N	STRIK_V	HCL_FLG	O	VHCL_TYP_SHO	VHCL_USE_S	TRLR_QT	VHCL_OWNS	HP_SHORT_D	VHCL_MVMN	VHCL_CMPSS_D	IR_FROM_SHOR	IR_TO_SHORT_	VHCL_AC	VHCL_EVN	VHCL_EVN	VHCL_EVN	VHCL_CAU
NT_1_CD	NT_2_CD	NT_3_CD	USE_1_CD	USE_2_CD	USE_3_CD	NO	NO	NO	DEG NO	MINUTE NO	SEC NO	LONG	VHCL_ID	RT_DESC	ED_SEQ_N	HCL_FLG	O	VHCL_TYP_SHO	HORT_DESC	Y	ESC	SC	T_SHORT_DE	IR_DESC	T_DESC	TN_CD	T_1_CD	T_2_CD	T_3_CD	SE_1_CD		
						45	20	12.46	45.33679444	-122	46	17.15	-122.7714306	3083127	1		1	PSNGR CAR	NONE		0	PRVTE	TURN-R	NE	NW	000					00	
						45	20	12.46	45.33679444	-122	46	17.15	-122.7714306	3083128	0		2	PSNGR CAR	NONE		0	PRVTE	STOP	NE	NW	013					00	
						45	20	12.46	45.33679444	-122	46	17.15	-122.7714306	3207432	1		1	UNKNOWN	NONE		9	N/A	STRGHT	NE	SW	000					00	
						45	20	12.46	45.33679444	-122	46	17.15	-122.7714306	3207433	0		2	PSNGR CAR	NONE		9	N/A	STOP	NE	SW	011					00	
						45	20	12.46	45.33679444	-122	46	17.15	-122.7714306	3217471	1		1	SEMI TOW	NONE		9	N/A	TURN-L	NE	SE	000					00	
						45	20	12.46	45.33679444	-122	46	17.15	-122.7714306	3217472	0		2	PSNGR CAR	NONE		9	N/A	TURN-L	NE	SE	000					00	
						45	20	12.46	45.33679444	-122	46	17.15	-122.7714306	3044745	1		1	PSNGR CAR	NONE		0	PRVTE	STRGHT	SE	NW	000					00	
						45	20	12.46	45.33679444	-122	46	17.15	-122.7714306	3044746	0		2	PSNGR CAR	NONE		0	PRVTE	STOP	SE	NW	011					00	
						45	20	12.46	45.33679444	-122	46	17.15	-122.7714306	3083074	1		1	PSNGR CAR	NONE		0	PRVTE	STRGHT	SE	NW	000					00	
						45	20	12.46	45.33679444	-122	46	17.15	-122.7714306	3083075	0		2	PSNGR CAR	NONE		0	PRVTE	TURN-R	NE	NW	000					00	
						45	20	12.46	45.33679444	-122	46	17.15	-122.7714306	3113596	1		1	PSNGR CAR	NONE		0	PRVTE	STRGHT	SE	NW	000					00	
						45	20	12.46	45.33679444	-122	46	17.15	-122.7714306	3113597	0		2	PSNGR CAR	NONE		0	PRVTE	TURN-L	NE	SE	000					00	
						45	20	12.46	45.33679444	-122	46	17.15	-122.7714306	3185799	1		1	PSNGR CAR	NONE		0	PRVTE	TURN-R	NE	NW	000					00	
						45	20	12.46	45.33679444	-122	46	17.15	-122.7714306	3185800	0		2	PSNGR CAR	NONE		0	PRVTE	TURN-R	NE	NW	000					00	
						45	20	12.46	45.33679444	-122	46	17.15	-122.7714306	3185800	0		2	PSNGR CAR	NONE		0	PRVTE	TURN-R	NE	NW	000					00	
						45	20	12.46	45.33679444	-122	46	17.15	-122.7714306	3207434	1		1	PSNGR CAR	NONE		9	N/A	TURN-L	NE	SE	000					00	
						45	20	12.46	45.33679444	-122	46	17.15	-122.7714306	3207435	0		2	PSNGR CAR	NONE		9	N/A	STRGHT	SE	NW	000					00	
						45	20	12.46	45.33679444	-122	46	17.15	-122.7714306	3216837	1		1	PSNGR CAR	NONE		9	N/A	TURN-L	NE	SE	000					00	
						45	20	12.46	45.33679444	-122	46	17.15	-122.7714306	3216838	0		2	PSNGR CAR	NONE		9	N/A	STRGHT	SE	NW	000					00	
						45	20	12.46	45.33679444	-122	46	17.15	-122.7714306	3306731	1		1	PSNGR CAR	NONE		9	N/A	TURN-R	NE	NW	000					00	
						45	20	12.46	45.33679444	-122	46	17.15	-122.7714306	3306732	0		2	PSNGR CAR	NONE		9	N/A	STRGHT	SE	NW	000					00	
						45	20	12.47	45.33679722	-122	46	17.16	-122.7714333	3358501	1		1	PSNGR CAR	NONE		0	PRVTE	STRGHT	SE	NW	000					00	
						45	20	12.47	45.33679722	-122	46	17.16	-122.7714333	3358502	0		2	PSNGR CAR	NONE		0	PRVTE	TURN-L	NE	SE	000					00	
						45	20	12.46	45.33679444	-122	46	17.15	-122.7714306	3251867	1		1	PSNGR CAR	NONE		0	PRVTE	STRGHT	SE	NW	000					00	
						45	20	12.46	45.33679444	-122	46	17.15	-122.7714306	3251868	0		2	PSNGR CAR	NONE		0	PRVTE	TURN-L	NE	SE	000					00	
						45	20	12.46	45.33679444	-122	46	17.15	-122.7714306	3045786	1		1	PSNGR CAR	NONE		0	PRVTE	TURN-R	NE	NW	000					00	
						45	20	12.46	45.33679444	-122	46	17.15	-122.7714306	3045787	0		2	PSNGR CAR	NONE		0	PRVTE	STOP	NE	NW	013					00	
						45	20	12.46	45.33679444	-122	46	17.15	-122.7714306	3079325	1		1	PSNGR CAR	NONE		0	PRVTE	TURN-R	NE	NW	000					00	
						45	20	12.46	45.33679444	-122	46	17.15	-122.7714306	3079326	0		2	PSNGR CAR	NONE		0	PRVTE	STOP	NE	NW	013					00	
						45	20	12.46	45.33679444	-122	46	17.15	-122.7714306	3081966	1		1	PSNGR CAR	NONE		0	PRVTE	TURN-R	NE	NW	000					00	
						45	20	12.46	45.33679444	-122	46	17.15	-122.7714306	3081967	0		2	PSNGR CAR	NONE		0	PRVTE	STOP	NE	NW	013					00	
						45	20	12.46	45.33679444	-122	46	17.15	-122.7714306	3307445	1		1	PSNGR CAR	NONE		9	N/A	STRGHT	NE	SW	000					00	
						45	20	12.46	45.33679444	-122	46	17.15	-122.7714306	3307446	0		2	PSNGR CAR	NONE		9	N/A	STOP	NE	SW	011					00	
						45	20	12.46	45.33679444	-122	46	17.16	-122.7714333	3491367	1		1	PSNGR CAR	NONE		0	PRVTE	STRGHT	E	W	000					00	
						45	20	12.46	45.33679444	-122	46	17.16	-122.7714333	3491368	0		2	PSNGR CAR	NONE		0	PRVTE	STOP	E	W	011					00	
						45	20	12.46	45.33679444	-122	46	17.15	-122.7714306	3071378	1		1	PSNGR CAR	NONE		0	PRVTE	STRGHT	NE	SW	000					00	
						45	20	12.46	45.33679444	-122	46	17.15	-122.7714306	3071379	0		2	PSNGR CAR	NONE		0	PRVTE	STOP	NE	SW	011					00	
						45	20	12.46	45.33679444	-122	46	17.15	-122.7714306	3117693	1		1	PSNGR CAR	NONE		0	PRVTE	STRGHT	NE	SW	000					00	
						45	20	12.46	45.33679444	-122	46	17.15	-122.7714306	3117694	0		2	PSNGR CAR	NONE		0	PRVTE	STOP	NE	SW	011					00	
						45	20	12.46	45.33679444	-122	46	17.15	-122.7714306	3185994	1		1	PSNGR CAR	NONE		0	PRVTE	STRGHT	NE	SW	000					00	
						45	20	12.46	45.33679444	-122	46	17.15	-122.7714306	3185995	0		2	PSNGR CAR	NONE		0	PRVTE	STOP	NE	SW	011					00	
						45	20	12.46	45.33679444	-122	46	17.15	-122.7714306	3185995	0		2	PSNGR CAR	NONE		0	PRVTE	STOP	NE	SW	011					00	
						45	20	12.46	45.33679444	-122	46	17.15	-122.7714306	3196524	1		1	PSNGR CAR	NONE		9	N/A	STRGHT	NE	SW	000					00	
						45	20	12.46	45.33679444	-122	46	17.15	-122.7714306	3196525	0		2	PSNGR CAR	NONE		9	N/A	STRGHT	NE	SW	000					00	
						45	20	12.46	45.33679444	-122	46	17.15	-122.7714306	3316389	1		1	PSNGR CAR	NONE		9	N/A	STRGHT	NE	SW	000					00	
						45	20	12.46	45.33679444	-122	46	17.15	-122.7714306	3316390	0		2	PSNGR CAR	NONE		9	N/A	STOP	NE	SW	011					00	
						45	20	12.46	45.33679444	-122	46	17.15	-122.7714306	3475744	1		1	PSNGR CAR	NONE		0	PRVTE	STRGHT	NE	SW	000					00	
						45	20	12.46	45.33679444	-122	46	17.15	-122.7714306	3475745	0		2	PSNGR CAR	NONE		0	PRVTE	STOP	NE	SW	011					00	
						45	20	12.46	45.33679444	-122	46	17.15	-122.7714306	3475745	0		2	PSNGR CAR	NONE		0	PRVTE	STOP	NE	SW	011					00	
						45	20	12.46	45.33679444	-122	46	17.15	-122.7714306	3198735	1		1	PSNGR CAR	NONE		9	N/A	STRGHT	NE	SW	000					00	
						45	20	12.46	45.33679444	-122	46	17.15	-122.7714306	3198736	0		2	PSNGR CAR	NONE		9	N/A	TURN-R	NE	NW	000					00	
						45	20	12.46	45.33679444	-122	46	17.15	-122.7714306	3217473	1		1	PSNGR CAR	NONE		9	N/A	STRGHT	NE	SW	000					00	
						45	20	12.46	45.33679444	-122	46	17.15	-122.7714306	3217474	0		2	PSNGR CAR	NONE		9	N/A	TURN-R	NE	NW	000					00	
						45</																										

10. I-5 SB Ramps & BFR

CRASH_EV			CRASH_CA			LAT	LAT	LAT	LONGTD				VHCL_COD				VHCL_OWNS				VHCL_CMPSS_D				VHCL_EVN				VHCL_CAU
NT_1_CD	NT_2_CD	NT_3_CD	USE_1_CD	USE_2_CD	USE_3_CD	DEG NO	MINUTE NO	SEC NO	DEG NO	MINUTE NO	SEC NO	LONG	VHCL_ID	HCL_FLG	ED_SEQ_N	VHCL_TYP_SHO	VHCL_USE_S	TRLR_QT	HP_SHORT_D	T_SHORT_DE	IR_FROM_SHOR	IR_TO_SHORT_	VHCL_AC	TN_CD	T_1_CD	T_2_CD	T_3_CD	SE_1_CD	
013			07			45	20	14.95	45.33748611	-122	46	14.55	-122.7707083	3241808	0	3	PSNGR CAR	NONE	0	PRVTE	STOP	NE	SW	022	013				00
013			07			45	20	14.95	45.33748611	-122	46	14.55	-122.7707083	3241809	0	4	PSNGR CAR	NONE	0	PRVTE	STOP	NE	SW	022					00
			29			45	20	13.8	45.33716667	-122	46	16.04	-122.7711222	3231752	1	1	PSNGR CAR	NONE	9	N/A	STRGHT	NE	SW	000					00
			29			45	20	13.8	45.33716667	-122	46	16.04	-122.7711222	3231753	0	2	PSNGR CAR	NONE	9	N/A	STRGHT	NE	SW	000					00
			29			45	20	13.8	45.33716667	-122	46	16.04	-122.7711222	3252046	1	1	PSNGR CAR	NONE	9	N/A	STRGHT	NE	SW	000					00
			29			45	20	13.8	45.33716667	-122	46	16.04	-122.7711222	3252047	0	2	PSNGR CAR	NONE	9	N/A	STOP	NE	SW	011					00
			29			45	20	13.38	45.33705	-122	46	16.47	-122.7712417	3256871	1	1	PSNGR CAR	NONE	9	N/A	STRGHT	NE	SW	000					00
			29			45	20	13.38	45.33705	-122	46	16.47	-122.7712417	3256872	0	2	PSNGR CAR	NONE	9	N/A	STOP	NE	SW	011					00
			29			45	20	13.38	45.33705	-122	46	16.47	-122.7712417	3030152	1	1	PSNGR CAR	NONE	0	PRVTE	STRGHT	NE	SW	000					00
			29			45	20	13.38	45.33705	-122	46	16.47	-122.7712417	3030153	0	2	PSNGR CAR	NONE	0	PRVTE	STOP	NE	SW	011					00
			29			45	20	12.46	45.33679444	-122	46	17.15	-122.7714306	3254894	1	1	PSNGR CAR	NONE	9	N/A	STRGHT	NE	SW	000					00
			29			45	20	12.46	45.33679444	-122	46	17.15	-122.7714306	3254895	0	2	PSNGR CAR	NONE	9	N/A	STOP	NE	SW	011					00
			29			45	20	12.46	45.33679444	-122	46	17.15	-122.7714306	3247471	1	1	PSNGR CAR	NONE	0	PRVTE	STRGHT	NE	SW	000					00
			29			45	20	12.46	45.33679444	-122	46	17.15	-122.7714306	3247472	0	2	PSNGR CAR	NONE	0	PRVTE	STOP	NE	SW	011					00

10. I-5 SB Ramps & BFR

VHCL_CAU		STRIK_P		PARTIC_VH		PARTIC_TYP		PARTIC_MVM		PARTIC_CMPSS		PARTIC_CMPSS		DRVR_LIC_ST		NON_MOTRST							TOTAL_CR		TOTAL_RO						
SE_2_CD	SE_3_CD	PARTIC_ID	ARTIC_FLG	CL_SEQ_NO	P_CD	C	SHORT_DES	NT_SHORT_D	DIR_FROM_SHOR	DIR_TO_SHORT	INJ_SVRTY_S	HORT_DESC	AGE_VAL	SEX_CD	AT_SHORT_D	DRVR_RES_S	PARTIC_AC	LOC_SHORT	PARTIC_E	PARTIC_E	PARTIC_E	PARTIC_EV	PARTIC_EV	PARTIC_EV	PARTIC_CA	PARTIC_CA	PARTIC_CA	ASHES	WS		
		3522286	0	1	1	DRVR					NONE	00	1	1	UNK	UNK	000		026									29	38	82	
		3522287	0	1	1	DRVR					NONE	37	1	1	OR-Y	OR>25	000		000										00	38	82
		3660279	0	1	1	DRVR					NONE	00	9	1	UNK	UNK	000		000										00	38	82
		3660280	0	1	1	DRVR					NONE	00	9	1	UNK	UNK	000		000										00	38	82
		3670063	0	1	1	DRVR					NONE	00	9	1	UNK	UNK	000		000										00	38	82
		3670064	0	1	1	DRVR					NONE	00	9	1	UNK	UNK	000		000										00	38	82
		3475379	0	1	1	DRVR					NONE	20	1	1	OR-Y	OR<25	000		026										29	38	82
		3475380	0	1	1	DRVR					INJC	55	1	1	OR-Y	OR<25	000		000										00	38	82
		3522232	0	1	1	DRVR					NONE	65	1	1	OR-Y	OR<25	000		000										00	38	82
		3522233	0	1	1	DRVR					NONE	75	2	2	OR-Y	OR<25	000		028										02	38	82
		3552539	0	1	1	DRVR					NONE	55	2	2	OTH-Y	N-RES	000		020										04	38	82
		3552540	0	1	1	DRVR					NONE	53	2	2	OR-Y	OR<25	000		000										00	38	82
		3639181	0	1	1	DRVR					NONE	41	2	2	OTH-Y	N-RES	038		042	016									27	38	82
		3639182	0	1	1	DRVR					INJC	30	2	2	OR-Y	OR<25	000		000										00	38	82
		3639183	0	2	2	PSNG					NO<5	01	2	2			000		000										00	38	82
		3660281	0	1	1	DRVR					NONE	00	9	1	UNK	UNK	000		000										00	38	82
		3660282	0	1	1	DRVR					NONE	00	9	1	UNK	UNK	000		000										00	38	82
		3669447	0	1	1	DRVR					NONE	00	9	1	UNK	UNK	000		000										00	38	82
		3669448	0	1	1	DRVR					NONE	00	9	1	UNK	UNK	000		000										00	38	82
		3772448	0	1	1	DRVR					NONE	00	9	1	UNK	UNK	000		000										00	38	82
		3772449	0	1	1	DRVR					NONE	00	9	1	UNK	UNK	000		000										00	38	82
		3826570	0	1	1	DRVR					NONE	17	2	2	OR-Y	OR<25	000		097										00	38	82
		3826571	0	1	1	DRVR					INJC	17	2	2	OR-Y	OR<25	000		097										00	38	82
		3706682	0	1	1	DRVR					NONE	37	2	2	OR-Y	OR<25	000		020										04	38	82
		3706683	0	1	1	DRVR					INJC	33	2	2	OR-Y	OR<25	000		000										00	38	82
		3476724	0	1	1	DRVR					NONE	00	1	1	UNK	UNK	000		026										29	38	82
		3476725	0	1	1	DRVR					INJC	30	2	2	OR-Y	OR<25	000		000										00	38	82
		3518531	0	1	1	DRVR					NONE	00	1	1	OTH-Y	N-RES	000		026										29	38	82
		3518532	0	1	1	DRVR					NONE	43	2	2	OR-Y	OR<25	000		000										00	38	82
		3521152	0	1	1	DRVR					NONE	45	1	1	OR-Y	OR<25	000		026										29	38	82
		3521153	0	1	1	DRVR					NONE	00	1	1	OR-Y	OR>25	000		000										00	38	82
		3773146	0	1	1	DRVR					NONE	00	9	1	UNK	UNK	000		000										00	38	82
		3773147	0	1	1	DRVR					NONE	00	9	1	UNK	UNK	000		000										00	38	82
		3979012	0	1	1	DRVR					NONE	37	2	2	OR-Y	OR<25	000		026										29	38	82
		3979013	0	1	1	DRVR					INJC	20	1	1	OR-Y	OR<25	000		000										00	38	82
		3508648	0	1	1	DRVR					NONE	47	1	1	NONE	OR<25	000		043										07	38	82
		3508649	0	1	1	DRVR					INJC	50	2	2	OR-Y	OR<25	000		000										00	38	82
		3556569	0	1	1	DRVR					NONE	68	2	2	OR-Y	OR<25	000		026										29	38	82
		3556570	0	1	1	DRVR					NONE	68	2	2	OR-Y	OR<25	000		000										00	38	82
		3639422	0	1	1	DRVR					NONE	41	2	2	OTH-Y	N-RES	000		026	016									27	38	82
		3639423	0	1	1	DRVR					INJC	30	2	2	OR-Y	OR<25	000		000										00	38	82
		3639424	0	2	2	PSNG					NO<5	01	2	2			000		000										00	38	82
		3649648	0	1	1	DRVR					NONE	00	9	1	UNK	UNK	000		000										00	38	82
		3649649	0	1	1	DRVR					NONE	00	9	1	UNK	UNK	000		000										00	38	82
		3781857	0	1	1	DRVR					NONE	00	9	1	UNK	UNK	000		000										00	38	82
		3781858	0	1	1	DRVR					NONE	00	9	1	UNK	UNK	000		000										00	38	82
		3960338	0	1	1	DRVR					NONE	49	2	2	OR-Y	OR<25	000		026										29	38	82
		3960339	0	1	1	DRVR					NONE	25	2	2	OR-Y	OR<25	000		000										00	38	82
		3960340	0	2	2	PSNG					INJC	23	2	2			000		000										00	38	82
		3651808	0	1	1	DRVR					NONE	00	9	1	UNK	UNK	000		000										00	38	82
		3651809	0	1	1	DRVR					NONE	00	9	1	UNK	UNK	000		000										00	38	82
		3670065	0	1	1	DRVR					NONE	00	9	1	UNK	UNK	000		000										00	38	82
		3670066	0	1	1	DRVR					NONE	00	9	1	UNK	UNK	000		000										00	38	82
		3710035	0	1	1	DRVR					NONE	00	9	1	UNK	UNK	000		000										00	38	82
		3710036	0	1	1	DRVR					NONE	00	9	1	UNK	UNK	000		000										00	38	82
		3940348	0	1	1	DRVR					NONE	00	9	1	UNK	UNK	000		000										00	38	82
		3940349	0	1	1	DRVR					NONE	00	9	1	UNK	UNK	000		000										00	38	82
		3940745	0	1	1	DRVR					NONE	00	9	1	UNK	UNK	000		000										00	38	82
		3940746	0	1	1	DRVR					NONE	00	9	1	UNK	UNK	000		000										00	38	82
		3639052	0	1	1	DRVR					NONE	19	1	1	OR-Y	OR<25	000		026										29	38	82
		3639053	0	1	1	DRVR					INJC	68	1	1	OR-Y	OR<25	000		000										00	38	82
		3880309	0	1	1	DRVR					NONE	00	9	1	UNK	UNK	000		000										00	38	82
		3880310	0	1	1	DRVR					NONE	00	9	1	UNK	UNK	000		000										00	38	82
		3871334	0	1	1	DRVR					NONE	20	1	1	OR-Y	OR<25	000		043	042									07	38	82
		3871335	0	1	1	DRVR					INJB	45	1	1	OR-Y	OR<25	022		000										00	38	82

10. I-5 SB Ramps & BFR

VHCL_CAU		PARTIC_TYP PARTIC_MVM PARTIC_CMPSS_ PARTIC_CMPSS_										DRVR_LIC_ST		NON_MOTRST													
SE_2_CD	SE_3_CD	PARTIC_ID	ARTIC_FLG	CL_SEQ_NO	P_CD	C	ESC	T_DESC	_DESC	HORT_DESC	AGE_VAL	SEX_CD	ESC	HORT_DESC	TN_CD	DESC	RR_1_CD	RR_2_CD	RR_3_CD	NT_1_CD	NT_2_CD	NT_3_CD	USE_1_CD	USE_2_CD	USE_3_CD	ASHES	WS
		3694488	0	1	1	DRVR				NONE	29	1	OTH-Y	N-RES	000		000						00			38	82
		3694489	0	1	1	DRVR				INJC	26	2	OR-Y	OR<25	000		000						00			38	82
		3683981	0	1	1	DRVR				NONE	00	9	UNK	UNK	000		000						00			38	82
		3683982	0	1	1	DRVR				NONE	00	9	UNK	UNK	000		000						00			38	82
		3706892	0	1	1	DRVR				NONE	00	9	UNK	UNK	000		000						00			38	82
		3706893	0	1	1	DRVR				NONE	00	9	UNK	UNK	000		000						00			38	82
		3712222	0	1	1	DRVR				NONE	00	9	UNK	UNK	000		000						00			38	82
		3712223	0	1	1	DRVR				NONE	00	9	UNK	UNK	000		000						00			38	82
		3457515	0	1	1	DRVR				NONE	18	1	OR-Y	OR<25	000		026						29			38	82
		3457516	0	1	1	DRVR				INJC	47	2	OR-Y	OR<25	000		000						00			38	82
		3710030	0	1	1	DRVR				NONE	00	9	UNK	UNK	000		000						00			38	82
		3710031	0	1	1	DRVR				NONE	00	9	UNK	UNK	000		000						00			38	82
		3701339	0	1	1	DRVR				NONE	53	1	OTH-Y	N-RES	000		026						29			38	82
		3701340	0	1	1	DRVR				INJC	58	1	OR-Y	OR<25	000		000						00			38	82

11. I-5 NB Ramps & Ellisen

CRASH_ID	INT_ID	SER_NO	INVSTG_AGY		ALCHL_IN	DRUG_INV	MJ_INVLV	SCHL_ZON	WRK_ZON	LANE_RDWY		UNLOCT	CRASH_HR_		CNTY_NM	CITY_SECT_NM	URB_AREA_SHORT_	HWY_NO	HWY_MED_NM	RDWY_NO	FC_CD	HWY_COMPN		MLGE_TY	RD_CON_	LRS_VAL	
			_SHORT_DES	CRASH_SPEE						D_INVLV_FLG	VLV_FLG		LV_FLG	_FLG								E_IND	E_IND				FLG
1621728	11	83819	NONE	0	0	0	0	0	0	N	FALSE	9/16/2015	4	12P	Washington	Wilsonville	PORTLAND UA	141	BEAVERTON-TUALATIN	2	16	0	MN	0		014100200S00	
1621728	11	83819	NONE	0	0	0	0	0	0	N	FALSE	9/16/2015	4	12P	Washington	Wilsonville	PORTLAND UA	141	BEAVERTON-TUALATIN	2	16	0	MN	0		014100200S00	
1684519	11	85119	COUNTY	0	0	0	0	0	0	N	FALSE	11/5/2016	7	1P	Washington	Wilsonville	PORTLAND UA	141	BEAVERTON-TUALATIN	1	11	6	CN	0	1	0141AB100S00	
1684519	11	85119	COUNTY	0	0	0	0	0	0	N	FALSE	11/5/2016	7	1P	Washington	Wilsonville	PORTLAND UA	141	BEAVERTON-TUALATIN	1	11	6	CN	0	1	0141AB100S00	
1684519	11	85119	COUNTY	0	0	0	0	0	0	N	FALSE	11/5/2016	7	1P	Washington	Wilsonville	PORTLAND UA	141	BEAVERTON-TUALATIN	1	11	6	CN	0	1	0141AB100S00	
1793598	11	84057	NONE	0	0	0	0	0	0	N	FALSE	11/2/2018	6	12P	Washington	Wilsonville	PORTLAND UA	141	BEAVERTON-TUALATIN	2	16	0	MN	0		014100200S00	
1793598	11	84057	NONE	0	0	0	0	0	0	N	FALSE	11/2/2018	6	12P	Washington	Wilsonville	PORTLAND UA	141	BEAVERTON-TUALATIN	2	16	0	MN	0		014100200S00	
1629008	11	81046	NONE	0	0	0	0	0	0	N	FALSE	3/26/2015	5	3P	Washington	Wilsonville	PORTLAND UA	141	BEAVERTON-TUALATIN	2	16	0	MN	0		014100200S00	
1629008	11	81046	NONE	0	0	0	0	0	0	N	FALSE	3/26/2015	5	3P	Washington	Wilsonville	PORTLAND UA	141	BEAVERTON-TUALATIN	2	16	0	MN	0		014100200S00	
1863950	11	06260	NONE	0	0	0	0	0	0	N	FALSE	11/28/2019	5	9P	Washington	Wilsonville	PORTLAND UA	141	BEAVERTON-TUALATIN	2	16	0	MN	0		014100200S00	
1863950	11	06260	NONE	0	0	0	0	0	0	N	FALSE	11/28/2019	5	9P	Washington	Wilsonville	PORTLAND UA	141	BEAVERTON-TUALATIN	2	16	0	MN	0		014100200S00	
1775759	11	01502	NONE	0	0	0	0	0	0	N	FALSE	1/21/2018	1	2P	Washington	Wilsonville	PORTLAND UA	141	BEAVERTON-TUALATIN	2	16	0	MN	0		014100200S00	
1775759	11	01502	NONE	0	0	0	0	0	0	N	FALSE	1/21/2018	1	2P	Washington	Wilsonville	PORTLAND UA	141	BEAVERTON-TUALATIN	2	16	0	MN	0		014100200S00	
1649747	11	84235	NONE	0	0	0	0	0	0	N	FALSE	10/13/2015	3	4P	Washington	Wilsonville	PORTLAND UA	141	BEAVERTON-TUALATIN	2	16	0	MN	0		014100200S00	
1649747	11	84235	NONE	0	0	0	0	0	0	N	FALSE	10/13/2015	3	4P	Washington	Wilsonville	PORTLAND UA	141	BEAVERTON-TUALATIN	2	16	0	MN	0		014100200S00	
1609274	11	81822	CITY	0	0	0	0	0	0	1	N	FALSE	5/13/2015	4	12P	Washington	Wilsonville	PORTLAND UA	141	BEAVERTON-TUALATIN	2	16	0	MN	0		014100200S00
1609274	11	81822	CITY	0	0	0	0	0	0	1	N	FALSE	5/13/2015	4	12P	Washington	Wilsonville	PORTLAND UA	141	BEAVERTON-TUALATIN	2	16	0	MN	0		014100200S00
1693368	11	81446	NONE	0	0	0	0	0	0	N	FALSE	3/22/2016	3	12P	Washington	Wilsonville	PORTLAND UA	141	BEAVERTON-TUALATIN	1	16	6	CN	0	1	0141AB100S00	
1693368	11	81446	NONE	0	0	0	0	0	0	N	FALSE	3/22/2016	3	12P	Washington	Wilsonville	PORTLAND UA	141	BEAVERTON-TUALATIN	1	16	6	CN	0	1	0141AB100S00	
1725121	11	82347	NONE	0	0	0	0	0	0	N	FALSE	6/15/2017	5	6P	Washington	Wilsonville	PORTLAND UA	141	BEAVERTON-TUALATIN	2	16	0	MN	0		014100200S00	
1725121	11	82347	NONE	0	0	0	0	0	0	N	FALSE	6/15/2017	5	6P	Washington	Wilsonville	PORTLAND UA	141	BEAVERTON-TUALATIN	2	16	0	MN	0		014100200S00	
1851420	11	84425	COUNTY	0	0	0	0	0	0	N	FALSE	12/9/2019	2	12P	Washington	Wilsonville	PORTLAND UA	141	BEAVERTON-TUALATIN	2	16	0	MN	0		014100200S00	
1851420	11	84425	COUNTY	0	0	0	0	0	0	N	FALSE	12/9/2019	2	12P	Washington	Wilsonville	PORTLAND UA	141	BEAVERTON-TUALATIN	2	16	0	MN	0		014100200S00	
1695358	11	81136	COUNTY	0	0	0	0	0	0	N	FALSE	3/11/2016	6	1P	Washington	Wilsonville	PORTLAND UA	141	BEAVERTON-TUALATIN	1	11	6	CN	0	1	0141AB100S00	
1695358	11	81136	COUNTY	0	0	0	0	0	0	N	FALSE	3/11/2016	6	1P	Washington	Wilsonville	PORTLAND UA	141	BEAVERTON-TUALATIN	1	11	6	CN	0	1	0141AB100S00	
1857159	11	80849	NONE	0	0	0	0	0	0	N	FALSE	2/28/2019	5	7A	Washington	Wilsonville	PORTLAND UA	141	BEAVERTON-TUALATIN	2	16	0	MN	0		014100200S00	
1857159	11	80849	NONE	0	0	0	0	0	0	N	FALSE	2/28/2019	5	7A	Washington	Wilsonville	PORTLAND UA	141	BEAVERTON-TUALATIN	2	16	0	MN	0		014100200S00	

11. I-5 NB Ramps & Elligsen

MP_NO	ST_NO	ST_NM	ISECT_ST_		RD_CHAR_CD	RD_CHAR_S	CMPSS_DI	CMPSS_DIR			IMPCT_L	MEDN_TYP_		TURNG_LE	TRAF_CNTL_DE				WTHR_CON			LGT_COND_		COLLIS_TYP_		CRASH_SVR
			NO	ISECT_ST_NM				R_CD	FROM_CD	SC		OC_CD	HORT_DESC		C	G_QTY	LN_QTY	ISECT_REL_FLG	VICE_SHORT_DE	OFF_RDW	RNDABT_F	DRVWY_R	D_SHORT_D	RD_SURF_S	SHORT_DES	
12.95	00201	SW BEAV-TUALATIN HY	00701	ELLIGSEN RD	1	INTER	4		SE	09	CROSS		1		0	YIELD	0	0	0	0	CLR	DRY	DAY	S-1STOP	REAR	INJ
12.95	00201	SW BEAV-TUALATIN HY	00701	ELLIGSEN RD	1	INTER	4		SE	09	CROSS		1		0	YIELD	0	0	0	0	CLR	DRY	DAY	S-1STOP	REAR	INJ
12.95	00201	SW BEAV-TUALATIN HY	00701	ELLIGSEN RD	1	INTER	5		S	06	4-LEG		1		0	TRF SIGNAL	0	0	0	0	RAIN	WET	DAY	S-1STOP	REAR	INJ
12.95	00201	SW BEAV-TUALATIN HY	00701	ELLIGSEN RD	1	INTER	5		S	06	4-LEG		1		0	TRF SIGNAL	0	0	0	0	RAIN	WET	DAY	S-1STOP	REAR	INJ
12.95	00201	SW BEAV-TUALATIN HY	00701	ELLIGSEN RD	1	INTER	5		S	06	CROSS		2		0	TRF SIGNAL	0	0	0	0	UNK	UNK	DAY	S-1STOP	REAR	INJ
12.95	00201	SW BEAV-TUALATIN HY	00701	ELLIGSEN RD	1	INTER	5		S	06	CROSS		2		0	TRF SIGNAL	0	0	0	0	UNK	UNK	DAY	S-1STOP	REAR	INJ
12.95	00201	SW BEAV-TUALATIN HY	00701	ELLIGSEN RD	1	INTER	5		S	09	4-LEG		1		0	YIELD	0	0	0	0	CLR	DRY	DAY	S-1STOP	REAR	INJ
12.95	00201	SW BEAV-TUALATIN HY	00701	ELLIGSEN RD	1	INTER	5		S	09	4-LEG		1		0	YIELD	0	0	0	0	CLR	DRY	DAY	S-1STOP	REAR	INJ
12.95	00201	SW BEAV-TUALATIN HY	00701	ELLIGSEN RD	1	INTER	9		CN	04	CROSS		2		0	TRF SIGNAL	0	0	0	0	CLR	WET	DLIT	S-OTHER	TURN	PDO
12.95	00201	SW BEAV-TUALATIN HY	00701	ELLIGSEN RD	1	INTER	9		CN	04	CROSS		2		0	TRF SIGNAL	0	0	0	0	CLR	WET	DLIT	S-OTHER	TURN	PDO
12.95	00207	NB BEAV-TUALATIN HY	00701	ELLIGSEN RD	1	INTER	4		SE	09	4-LEG		1		0	TRF SIGNAL	0	0	0	0	CLR	DRY	DAY	S-1STOP	REAR	INJ
12.95	00207	NB BEAV-TUALATIN HY	00701	ELLIGSEN RD	1	INTER	4		SE	09	4-LEG		1		0	TRF SIGNAL	0	0	0	0	CLR	DRY	DAY	S-1STOP	REAR	INJ
12.95	00207	NB BEAV-TUALATIN HY	00701	ELLIGSEN RD	1	INTER	5		S	06	3-LEG		1		0	TRF SIGNAL	0	0	0	0	CLR	DRY	DAY	S-1STOP	REAR	PDO
12.95	00207	NB BEAV-TUALATIN HY	00701	ELLIGSEN RD	1	INTER	5		S	06	3-LEG		1		0	TRF SIGNAL	0	0	0	0	CLR	DRY	DAY	S-1STOP	REAR	PDO
12.95	00207	NB BEAV-TUALATIN HY	00701	ELLIGSEN RD	1	INTER	5		S	09	4-LEG		2		0	YIELD	0	0	0	0	CLR	DRY	DAY	S-1STOP	REAR	INJ
12.95	00207	NB BEAV-TUALATIN HY	00701	ELLIGSEN RD	1	INTER	5		S	09	4-LEG		2		0	YIELD	0	0	0	0	CLR	DRY	DAY	S-1STOP	REAR	INJ
12.95	00207	NB BEAV-TUALATIN HY	00701	ELLIGSEN RD	1	INTER	5		S	09	4-LEG		1		0	YIELD	0	0	0	0	CLR	DRY	DAY	S-1STOP	REAR	PDO
12.95	00207	NB BEAV-TUALATIN HY	00701	ELLIGSEN RD	1	INTER	5		S	09	4-LEG		1		0	YIELD	0	0	0	0	CLR	DRY	DAY	S-1STOP	REAR	PDO
12.95	00207	NB BEAV-TUALATIN HY	00701	ELLIGSEN RD	1	INTER	5		S	09	CROSS		1		0	YIELD	0	0	0	0	RAIN	WET	DAY	S-1STOP	REAR	PDO
12.95	00207	NB BEAV-TUALATIN HY	00701	ELLIGSEN RD	1	INTER	5		S	09	CROSS		1		0	YIELD	0	0	0	0	RAIN	WET	DAY	S-1STOP	REAR	PDO
12.95	00207	NB BEAV-TUALATIN HY	00701	ELLIGSEN RD	1	INTER	5		S	09	4-LEG		1		0	TRF SIGNAL	0	0	0	0	CLD	DRY	DAY	S-1STOP	REAR	INJ
12.95	00207	NB BEAV-TUALATIN HY	00701	ELLIGSEN RD	1	INTER	5		S	09	4-LEG		1		0	TRF SIGNAL	0	0	0	0	CLD	DRY	DAY	S-1STOP	REAR	INJ
12.95	00207	NB BEAV-TUALATIN HY	00701	ELLIGSEN RD	1	INTER	7		W	06	4-LEG		1		0	TRF SIGNAL	0	0	0	0	RAIN	WET	DAY	S-1STOP	REAR	PDO
12.95	00207	NB BEAV-TUALATIN HY	00701	ELLIGSEN RD	1	INTER	7		W	06	4-LEG		1		0	TRF SIGNAL	0	0	0	0	RAIN	WET	DAY	S-1STOP	REAR	PDO
12.95	00207	NB BEAV-TUALATIN HY	00701	ELLIGSEN RD	1	INTER	9		CN	04	4-LEG		1		0	TRF SIGNAL	0	0	0	0	CLR	DRY	DAY	ANGL-OTH	ANGL	PDO
12.95	00207	NB BEAV-TUALATIN HY	00701	ELLIGSEN RD	1	INTER	9		CN	04	4-LEG		1		0	TRF SIGNAL	0	0	0	0	CLR	DRY	DAY	ANGL-OTH	ANGL	PDO

11. I-5 NB Ramps & Elligsen

CRASH_EV			CRASH_CA			LAT			LONGTD			VHCL_COD			VHCL_OWNS			VHCL_MVMN			VHCL_CMPSS_D			VHCL_EVN			VHCL_CAU		
NT_1_CD	NT_2_CD	NT_3_CD	USE_1_CD	USE_2_CD	USE_3_CD	DEG	MINUTE	SEC	DEG	MINUTE	SEC	DEG	MINUTE	SEC	VHCL_ID	HCL_FLG	O	RT_DESC	HORT_DESC	Y	ESC	SC	T_DESC	DESC	TN_CD	T_1_CD	T_2_CD	T_3_CD	SE_1_CD
						45	20	8.18	45.33560556	-122	46	2.09	-122.7672472	3063306	1	1	PSNGR CAR	NONE	0	PRVTE	TURN-R	S	E	000				00	
						45	20	8.18	45.33560556	-122	46	2.09	-122.7672472	3063307	0	2	PSNGR CAR	NONE	0	PRVTE	STOP	S	E	013				00	
124						45	20	8.18	45.33560556	-122	46	2.09	-122.7672472	3180819	1	1	PSNGR CAR	NONE	0	PRVTE	STRGHT	N	S	000	124			00	
124						45	20	8.18	45.33560556	-122	46	2.09	-122.7672472	3180820	0	2	PSNGR CAR	NONE	0	PRVTE	STOP	N	S	011				00	
124						45	20	8.18	45.33560556	-122	46	2.09	-122.7672472	3180820	0	2	PSNGR CAR	NONE	0	PRVTE	STOP	N	S	011				00	
						45	20	8.19	45.33560833	-122	46	2.11	-122.7672528	3380614	1	1	PSNGR CAR	NONE	0	PRVTE	STRGHT	S	N	000				00	
						45	20	8.19	45.33560833	-122	46	2.11	-122.7672528	3380615	0	2	PSNGR CAR	NONE	0	PRVTE	STOP	S	N	011				00	
						45	20	8.18	45.33560556	-122	46	2.09	-122.7672472	3076718	1	1	PSNGR CAR	NONE	0	PRVTE	TURN-R	S	E	000				00	
						45	20	8.18	45.33560556	-122	46	2.09	-122.7672472	3076719	0	2	PSNGR CAR	NONE	0	PRVTE	STOP	S	E	013				00	
			08			45	20	8.18	45.33560556	-122	46	2.09	-122.7672472	3509704	1	1	PSNGR CAR	NONE	9	N/A	TURN-R	S	E	000				00	
			08			45	20	8.18	45.33560556	-122	46	2.09	-122.7672472	3509705	0	2	PSNGR CAR	NONE	9	N/A	TURN-L	S	W	000				00	
						45	20	8.18	45.33560556	-122	46	2.09	-122.7672472	3346810	1	1	PSNGR CAR	NONE	0	PRVTE	TURN-R	S	E	000				00	
						45	20	8.18	45.33560556	-122	46	2.09	-122.7672472	3346811	0	2	PSNGR CAR	NONE	0	UNKN	STOP	S	E	011				00	
						45	20	8.18	45.33560556	-122	46	2.09	-122.7672472	3114993	1	1	PSNGR CAR	NONE	0	PRVTE	STRGHT	S	N	000				00	
						45	20	8.18	45.33560556	-122	46	2.09	-122.7672472	3114994	0	2	PSNGR CAR	NONE	0	PRVTE	STOP	S	N	011				00	
						45	20	8.18	45.33560556	-122	46	2.09	-122.7672472	3039190	1	1	PSNGR CAR	NONE	0	PRVTE	TURN-R	S	E	000				00	
						45	20	8.18	45.33560556	-122	46	2.09	-122.7672472	3039191	0	2	PSNGR CAR	NONE	0	PRVTE	STOP	S	E	013				00	
						45	20	8.18	45.33560556	-122	46	2.09	-122.7672472	3196879	1	1	PSNGR CAR	NONE	9	N/A	STRGHT	S	N	000				00	
						45	20	8.18	45.33560556	-122	46	2.09	-122.7672472	3196880	0	2	PSNGR CAR	NONE	9	N/A	STOP	S	N	013				00	
						45	20	8.18	45.33560556	-122	46	2.09	-122.7672472	3254483	1	1	PSNGR CAR	NONE	9	N/A	STRGHT	S	N	000				00	
						45	20	8.18	45.33560556	-122	46	2.09	-122.7672472	3254484	0	2	PSNGR CAR	NONE	9	N/A	STOP	S	N	011				00	
						45	20	8.18	45.33560556	-122	46	2.09	-122.7672472	3487309	1	1	PSNGR CAR	NONE	0	PRVTE	STRGHT	S	N	000				00	
						45	20	8.18	45.33560556	-122	46	2.09	-122.7672472	3487310	0	2	PSNGR CAR	NONE	0	PRVTE	STOP	S	N	011				00	
						45	20	8.18	45.33560556	-122	46	2.09	-122.7672472	3200293	1	1	PSNGR CAR	NONE	9	N/A	STRGHT	W	E	000				00	
						45	20	8.18	45.33560556	-122	46	2.09	-122.7672472	3200294	0	2	PSNGR CAR	NONE	9	N/A	STOP	W	E	011				00	
						45	20	8.16	45.3356	-122	46	2.12	-122.7672556	3497606	1	1	PSNGR CAR	NONE	9	N/A	STRGHT	W	E	000				00	
						45	20	8.16	45.3356	-122	46	2.12	-122.7672556	3497607	0	2	PSNGR CAR	NONE	9	N/A	STRGHT	S	N	000				00	

11. I-5 NB Ramps & Elligsen

VHCL_CAU		STRIK_P		PARTIC_TYP	PARTIC_MVM	PARTIC_CMPSS_	PARTIC_CMPSS_	DRVR_LIC_ST				NON_MOTRST									TOTAL_CR	TOTAL_RO									
SE_2_CD	SE_3_CD	PARTIC_ID	ARTIC_FLG	CL_SEQ_NO	P_CD	C	SHORT_DES	NT_SHORT_D	DIR_FROM_SHOR	DIR_TO_SHORT	HORT_DESC	AGE_VAL	SEX_CD	ESC	AT_SHORT_D	DRVR_RES_S	PARTIC_AC	LOC_SHORT_	PARTIC_E	PARTIC_E	PARTIC_E	PARTIC_EV	PARTIC_EV	PARTIC_EV	PARTIC_CA	PARTIC_CA	PARTIC_CA	ASHES	WS		
		3498434	0	1	1	DRVR					NONE	24	1	OR-Y	OR<25	000			026									29	43	88	
		3498435	0	1	1	DRVR					INJC	54	2	OR-Y	OR<25	000			000										00	43	88
		3633058	0	1	1	DRVR					NONE	26	2	OR-Y	OR>25	000			026										29	43	88
		3633059	0	1	1	DRVR					NONE	51	1	OR-Y	OR>25	000			000										00	43	88
		3633060	0	2	2	PSNG					INJC	55	2			000			000										00	43	88
		3854402	0	1	1	DRVR					NONE	69	2	OTH-Y	N-RES	000			026										29	43	88
		3854403	0	1	1	DRVR					INJC	33	2	OR-Y	OR<25	000			000										00	43	88
		3515359	0	1	1	DRVR					NONE	16	1	OR-Y	OR<25	000			026										29	43	88
		3515360	0	1	1	DRVR					INJC	59	2	OR-Y	OR<25	000			000										00	43	88
		3997022	0	1	1	DRVR					NONE	00	9	UNK	UNK	000			000										00	43	88
		3997023	0	1	1	DRVR					NONE	00	9	UNK	UNK	000			000										00	43	88
		3811817	0	1	1	DRVR					NONE	77	1	OR-Y	OR<25	000			026										29	43	88
		3811818	0	1	1	DRVR					INJC	49	2	OR-Y	OR<25	000			000										00	43	88
		3553916	0	1	1	DRVR					NONE	56	1	OR-Y	OR<25	000			026										29	43	88
		3553917	0	1	1	DRVR					NONE	49	1	OTH-Y	N-RES	000			000										00	43	88
		3468476	0	1	1	DRVR					NONE	45	2	OR-Y	OR<25	000			026	028									29	43	88
		3468477	0	1	1	DRVR					INJC	43	2	OR-Y	OR<25	000			000										00	43	88
		3649997	0	1	1	DRVR					NONE	00	9	UNK	UNK	000			000										00	43	88
		3649998	0	1	1	DRVR					NONE	00	9	UNK	UNK	000			000										00	43	88
		3709605	0	1	1	DRVR					NONE	00	9	UNK	UNK	000			000										00	43	88
		3709606	0	1	1	DRVR					NONE	00	9	UNK	UNK	000			000										00	43	88
		3974182	0	1	1	DRVR					NONE	39	1	OR-Y	OR<25	000			043										07	43	88
		3974183	0	1	1	DRVR					INJC	31	2	OTH-Y	N-RES	000			000										00	43	88
		3653325	0	1	1	DRVR					NONE	00	9	UNK	UNK	000			000										00	43	88
		3653326	0	1	1	DRVR					NONE	00	9	UNK	UNK	000			000										00	43	88
		3985308	0	1	1	DRVR					NONE	00	9	UNK	UNK	000			000										00	43	88
		3985309	0	1	1	DRVR					NONE	00	9	UNK	UNK	000			000										00	43	88

15. 65th & Norwood

CRASH_ID	INT_ID	SER_NO	INVTG_AGY		CRASH_SPEE	ALCHL_IN	DRUG_INV	MJ_INVLV	SCHL_ZON	WRK_ZON	LANE_RDWY		UNLOCT	CRASH_HR_			CNTY_NM	CITY_SECT_NM	URB_AREA_SHORT_			RDWY_NO	FC_CD	HWY_COMPN			MLGE_TY	RD_CON_	LRS	VAL			
			_SHORT_DES	C							D_INVLV_FLG	VLV_FLG		LV_FLG	_FLG	E_IND			E_IND	FLG	CRASH_DT			_DAY_CD	C	NM					HWY_NO	HWY_MED_NM	HWY_COM
1857960	15	02914	NONE		0	0	0		0	0	N		FALSE	6/7/2019	6	4P	Washington		PORTLAND UA				17										
1857960	15	02914	NONE		0	0	0		0	0	N		FALSE	6/7/2019	6	4P	Washington		PORTLAND UA				17										
1841608	15	03013	COUNTY		0	0	0		0	0	N		FALSE	6/13/2019	5	4P	Washington		PORTLAND UA				17										
1841608	15	03013	COUNTY		0	0	0		0	0	N		FALSE	6/13/2019	5	4P	Washington		PORTLAND UA				17										

15. 65th & Norwood

MP_NO	ST_NO	ST_NM	ISECT_ST_		RD_CHAR_CD	RD_CHAR_S	CMPSS_DI	CMPSS_DIR	SHORT_DE	IMPCT_L	MEDN_TYP_		TURNG_LE	TRAF_CNTL_DE				WTHR_CON			LGT_COND_		COLLIS_TYP_		CRASH_SVR
			NO	ISECT_ST_NM							HORT_DESC	R_CD		FROM_CD	SC	OC_CD	HORT_DESC	C	G_QTY	LN_QTY	FLG	SC	Y_FLG	LG	
01722	SW NORWOOD RD	05065	SW 65TH AVE	1	INTER	7	W	06	3-LEG			0	0	0	0	0	0	0	0	CLR	DRY	DAY	S-1STOP	REAR	PDO
01722	SW NORWOOD RD	05065	SW 65TH AVE	1	INTER	7	W	06	3-LEG			0	0	0	0	0	0	0	0	CLR	DRY	DAY	S-1STOP	REAR	PDO
01722	SW NORWOOD RD	05065	SW 65TH AVE	1	INTER	9	CN	03	3-LEG			0	0	0	0	0	0	0	0	CLR	DRY	DAY	ANGL-OTH	TURN	INJ
01722	SW NORWOOD RD	05065	SW 65TH AVE	1	INTER	9	CN	03	3-LEG			0	0	0	0	0	0	0	0	CLR	DRY	DAY	ANGL-OTH	TURN	INJ

15. 65th & Norwood

CRASH_EV			CRASH_CA			LAT			LONGTD				VHCL_COD				VHCL_OWNS				VHCL_MVMN				VHCL_CMPSS_D				
NT_1_CD	NT_2_CD	NT_3_CD	USE_1_CD	USE_2_CD	USE_3_CD	DEG NO	MINUTE NO	SEC NO	LAT	DEG NO	MINUTE NO	SEC NO	LONG	VHCL_ID	HCL_FLG	O	RT_DESC	HORT_DESC	Y	ESC	SC	T_DESC	DESC	TN_CD	T_1_CD	T_2_CD	T_3_CD	SE_1_CD	
			29			45	21	21.04	45.35584444	-122	44	37.63	-122.7437861	3498998	1	1	PSNGR CAR	NONE		9	N/A	STRGHT	W	E	000				00
			29			45	21	21.04	45.35584444	-122	44	37.63	-122.7437861	3498999	0	2	PSNGR CAR	NONE		9	N/A	STOP	W	E	012				00
			03			45	21	21.04	45.35584444	-122	44	37.63	-122.7437861	3468578	1	1	PSNGR CAR	NONE		0	PRVTE	STRGHT	N	S	000				00
			03			45	21	21.04	45.35584444	-122	44	37.63	-122.7437861	3468579	0	2	PSNGR CAR	NONE		0	PRVTE	TURN-L	W	N	000				00

15. 65th & Norwood

VHCL_CAU		STRIKG_P		PARTIC_VH	PARTIC_TY	SHORT_DES	NT_SHORT_D	DIR_FROM_SHOR	DIR_TO_SHORT	INJ_SVRTY_S	DRVR_LIC_ST		NON_MOTRST									TOTAL_CR	TOTAL_RO					
SE_2_CD	SE_3_CD	PARTIC_ID	ARTIC_FLG	CL_SEQ_NO	P_CD	C	ESC	T_DESC	_DESC	HORT_DESC	AGE_VAL	SEX_CD	ESC	HORT_DESC	TN_CD	DESC	RR_1_CD	RR_2_CD	RR_3_CD	NT_1_CD	NT_2_CD	NT_3_CD	USE_1_CD	USE_2_CD	USE_3_CD	ASHES	WS	
		3986663	0	1	1	DRVR				NONE	00	9	UNK	UNK	000		000										17	39
		3986664	0	1	1	DRVR				NONE	00	9	UNK	UNK	000		000										17	39
		3951752	0	1	1	DRVR				INJB	30	2	OR-Y	OR>25	000		000										17	39
		3951753	0	1	1	DRVR				NONE	21	2	OR-Y	OR<25	000		021										17	39

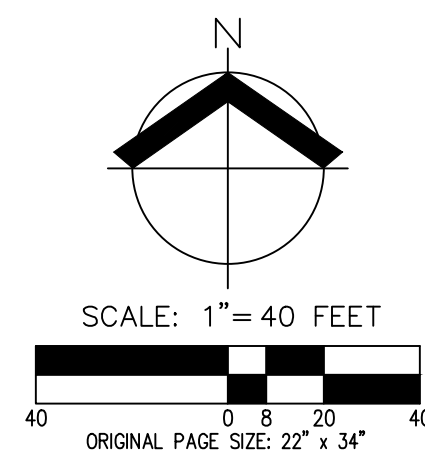
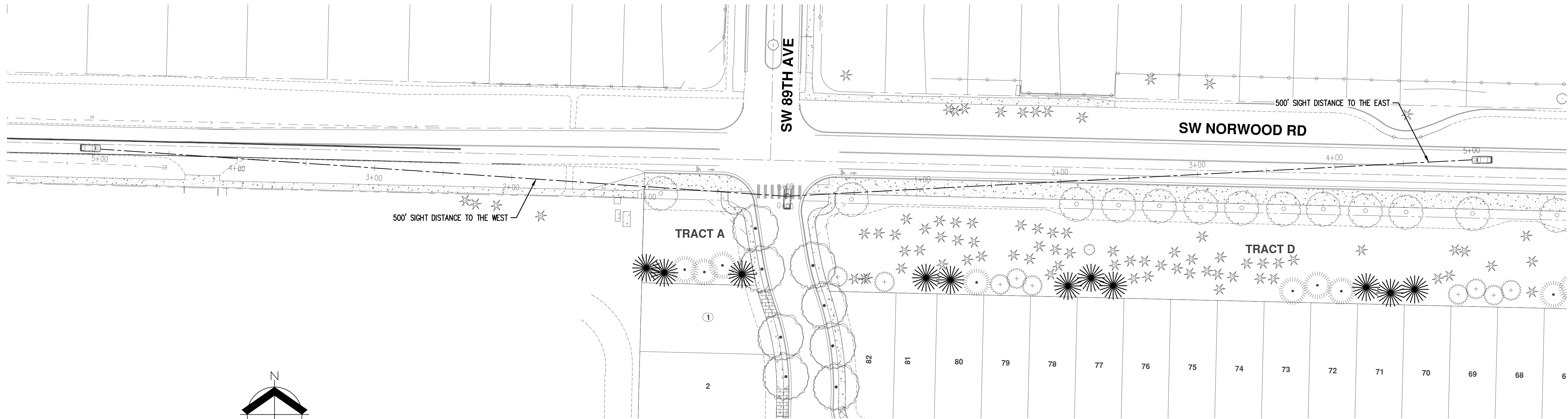

NOTE: EXISTING VEGETATION ALONG NORWOOD ROAD SOUTH TO BE REMOVED IN ORDER TO ACHIEVE SIGHT DISTANCE SHOWN

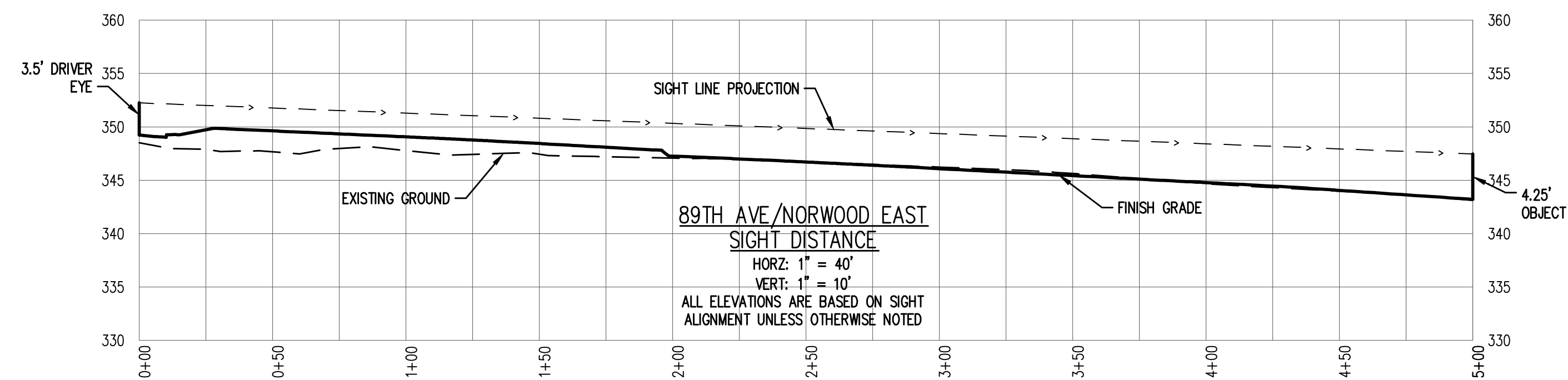
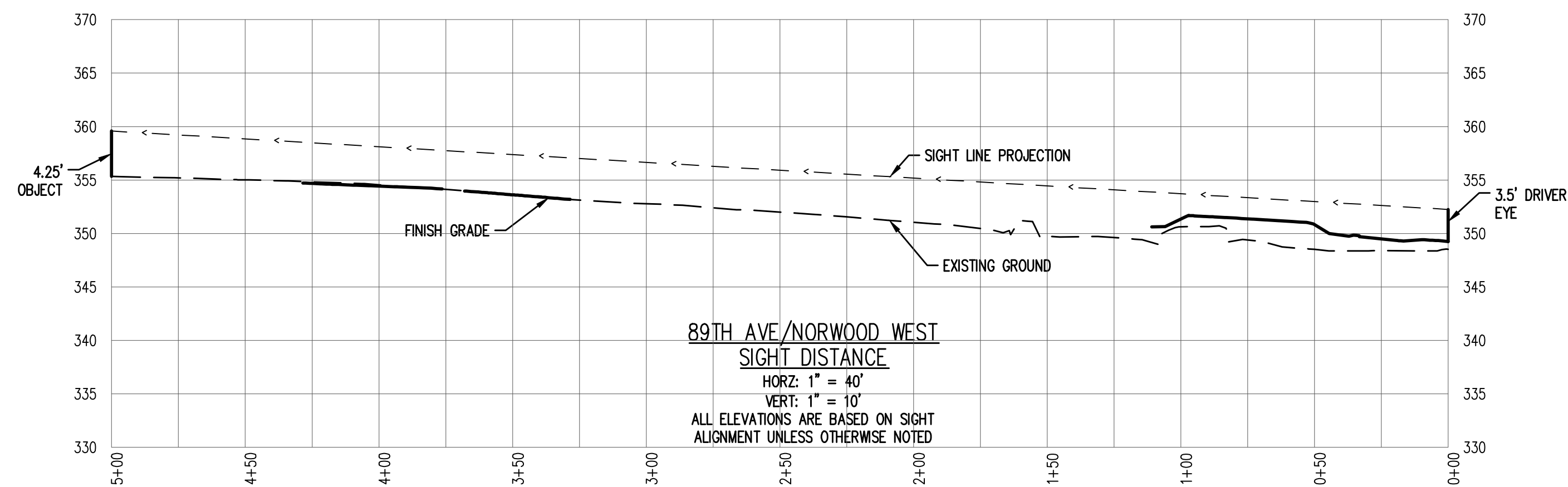

89TH AVENUE AND NORWOOD SIGHT DISTANCE

AUTUMN SUNRISE SUBDIVISION

LENNAR NORTHWEST, INC.

TUALATIN, OREGON

LENNAR®

AKS
AKS ENGINEERING & FORESTRY, LLC
11405 NW HERBERT RD., STE 100
TUALATIN, OR 97062
503.553.6451
WWW.AKS-ENG.COM

ENGINEERING · SURVEYING · NATURAL RESOURCES
FORESTRY · PLANNING · LANDSCAPE ARCHITECTURE



RENEWAL DATE: 6/30/22

JOB NUMBER: 7454
DATE: 7/1/2021
DESIGNED BY: JSM
DRAWN BY: JSM
CHECKED BY: DS

EX A

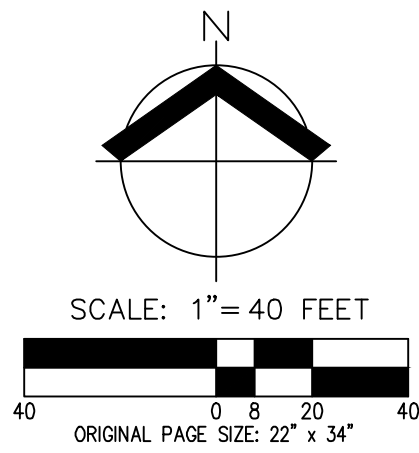

NOTE: EXISTING VEGETATION ALONG NORWOOD ROAD SOUTH TO BE REMOVED IN ORDER TO ACHIEVE SIGHT DISTANCE SHOWN

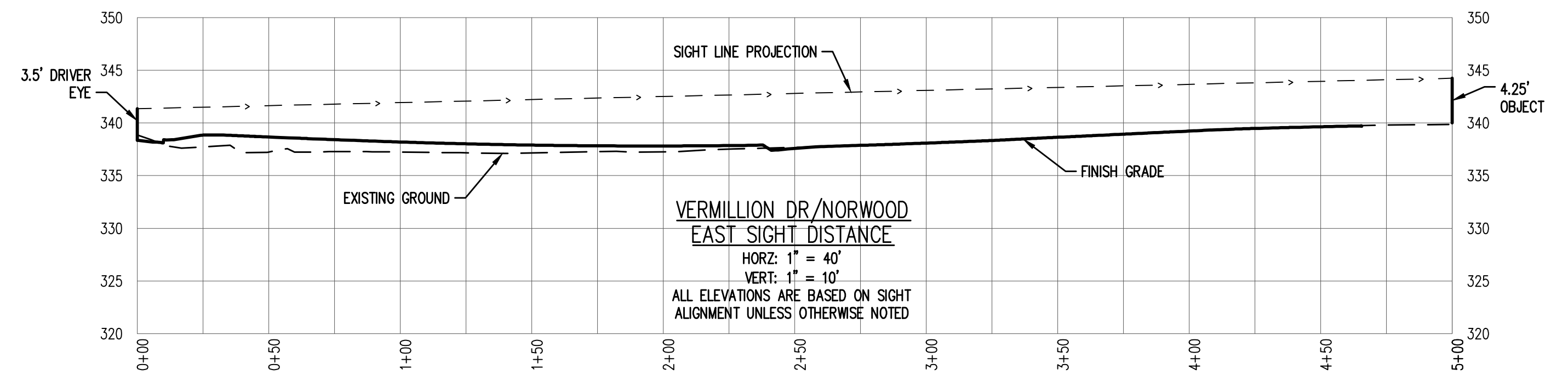
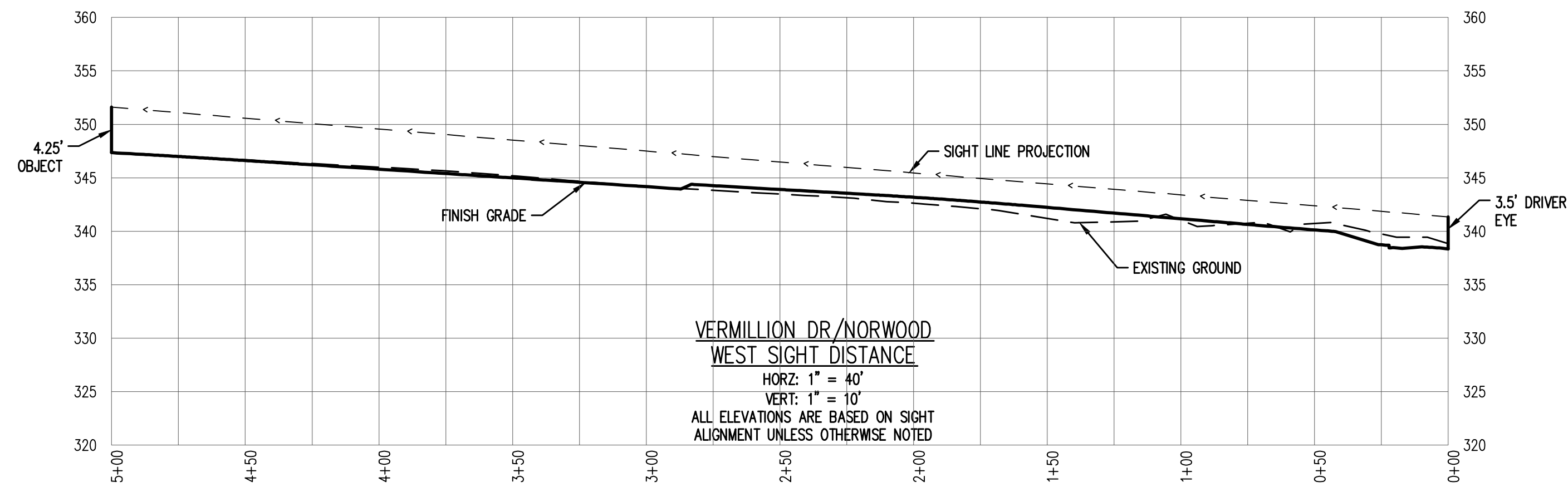

FAST 2

Preliminary Left-Turn Lane Warrant Summary

Intersection	Warrant Met?
SW 89th Ave/Site Access SW Norwood Road	
2026 Buildout - AM Peak Hour (EB)	No
2026 Buildout - AM Peak Hour (WB)	No
2026 Buildout - PM Peak Hour (EB)	No
2026 Buildout - PM Peak Hour (WB)	No
SW Vermillion Drive/Site Access SW Norwood Road	
2026 Buildout - AM Peak Hour (EB)	No
2026 Buildout - AM Peak Hour (WB)	No
2026 Buildout - PM Peak Hour (EB)	No
2026 Buildout - PM Peak Hour (WB)	No



Left-Turn Lane Warrant Analysis

Project: 21029 - Autumn Sunrise
Intersection: SW 89th Ave/Site Access SW Norwood Road
Date: 6/30/2021
Scenario: 2026 Buildout - AM Peak Hour (EB)

2-lane roadway (English)

INPUT

Variable	Value
85 th percentile speed, mph:	45
Percent of left-turns in advancing volume (V_A), %:	13%
Advancing volume (V_A), veh/h:	110
Opposing volume (V_O), veh/h:	152

OUTPUT

Variable	Value
Limiting advancing volume (V_A), veh/h:	407
Guidance for determining the need for a major-road left-turn bay:	
Left-turn treatment NOT warranted.	

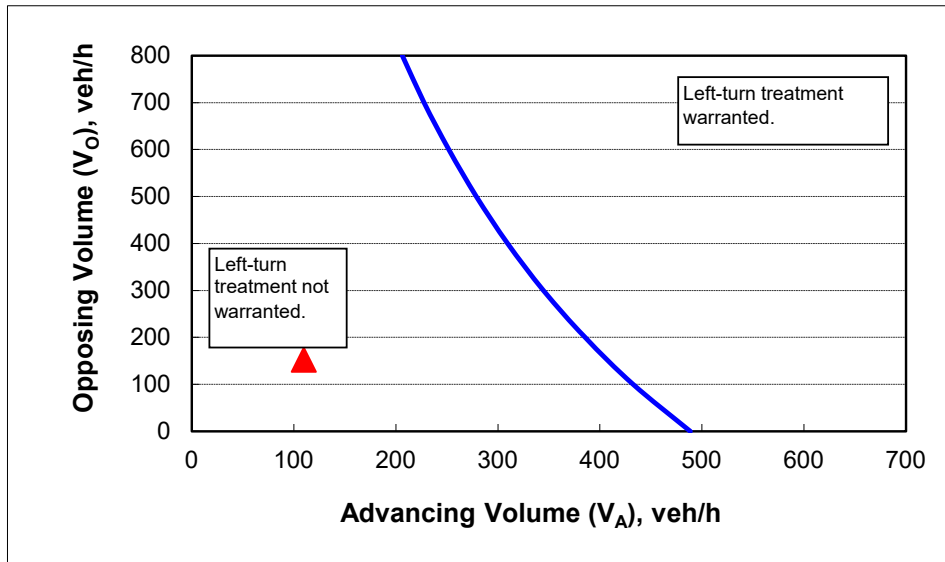

CALIBRATION CONSTANTS

Variable	Value
Average time for making left-turn, s:	3.0
Critical headway, s:	5.0
Average time for left-turn vehicle to clear the advancing lane, s:	1.9



Left-Turn Lane Warrant Analysis

Project: 21029 - Autumn Sunrise
 Intersection: SW 89th Ave/Site Access SW Norwood Road
 Date: 6/30/2021
 Scenario: 2026 Buildout - AM Peak Hour (WB)

2-lane roadway (English)

INPUT

Variable	Value
85 th percentile speed, mph:	45
Percent of left-turns in advancing volume (V_A), %:	1%
Advancing volume (V_A), veh/h:	153
Opposing volume (V_O), veh/h:	96

OUTPUT

Variable	Value
Limiting advancing volume (V_A), veh/h:	1798
Guidance for determining the need for a major-road left-turn bay:	
Left-turn treatment NOT warranted.	

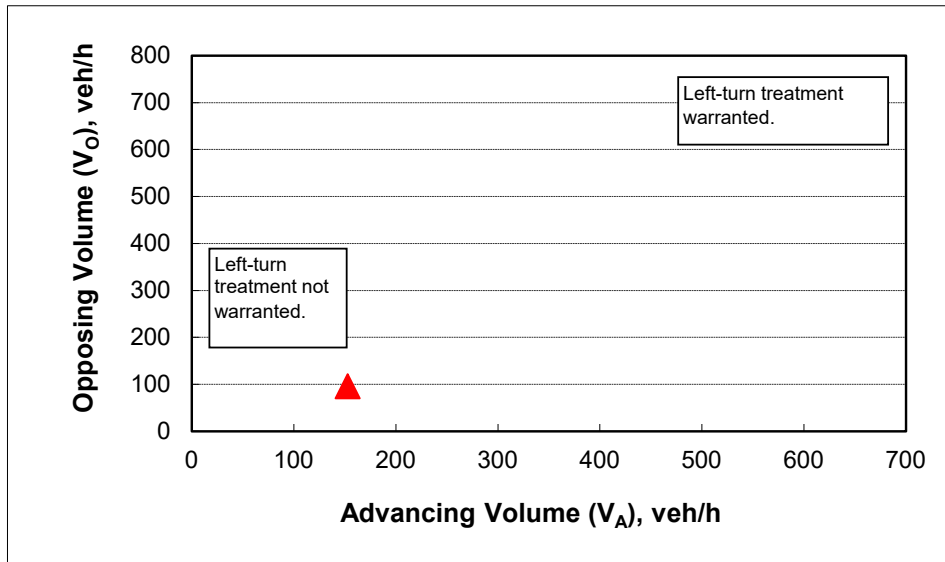

CALIBRATION CONSTANTS

Variable	Value
Average time for making left-turn, s:	3.0
Critical headway, s:	5.0
Average time for left-turn vehicle to clear the advancing lane, s:	1.9



Left-Turn Lane Warrant Analysis

Project: 21029 - Autumn Sunrise
 Intersection: SW 89th Ave/Site Access SW Norwood Road
 Date: 6/30/2021
 Scenario: 2026 Buildout - PM Peak Hour (EB)

2-lane roadway (English)

INPUT

Variable	Value
85 th percentile speed, mph:	45
Percent of left-turns in advancing volume (V_A), %:	11%
Advancing volume (V_A), veh/h:	293
Opposing volume (V_O), veh/h:	184

OUTPUT

Variable	Value
Limiting advancing volume (V_A), veh/h:	414
Guidance for determining the need for a major-road left-turn bay:	
Left-turn treatment NOT warranted.	

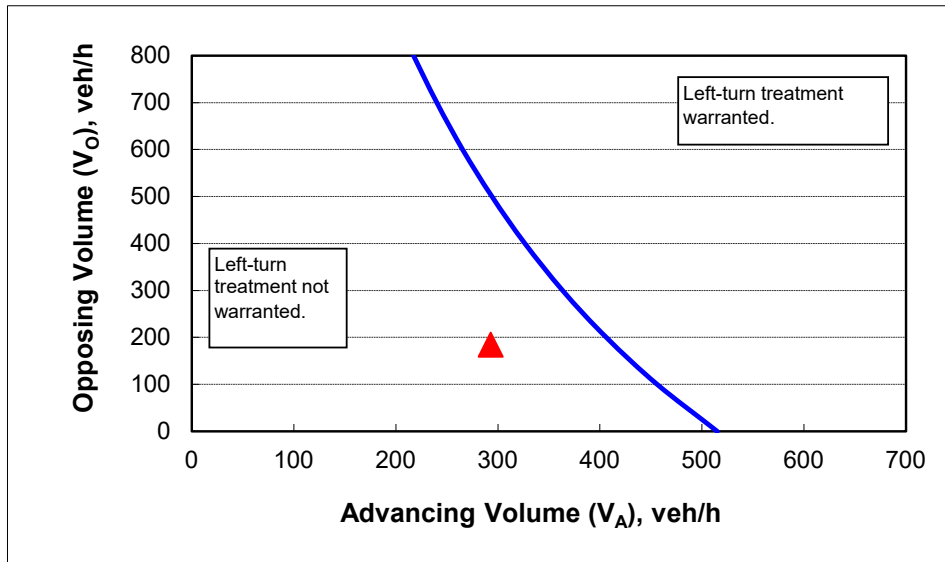

CALIBRATION CONSTANTS

Variable	Value
Average time for making left-turn, s:	3.0
Critical headway, s:	5.0
Average time for left-turn vehicle to clear the advancing lane, s:	1.9



Left-Turn Lane Warrant Analysis

Project: 21029 - Autumn Sunrise
 Intersection: SW 89th Ave/Site Access SW Norwood Road
 Date: 6/30/2021
 Scenario: 2026 Buildout - PM Peak Hour (WB)

2-lane roadway (English)

INPUT

Variable	Value
85 th percentile speed, mph:	45
Percent of left-turns in advancing volume (V_A), %:	3%
Advancing volume (V_A), veh/h:	189
Opposing volume (V_O), veh/h:	260

OUTPUT

Variable	Value
Limiting advancing volume (V_A), veh/h:	748
Guidance for determining the need for a major-road left-turn bay:	
Left-turn treatment NOT warranted.	

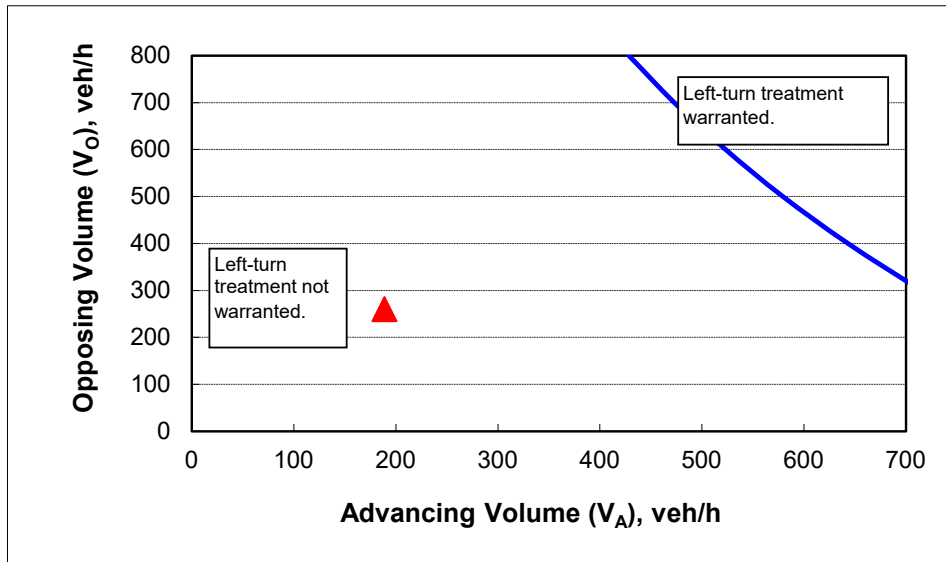

CALIBRATION CONSTANTS

Variable	Value
Average time for making left-turn, s:	3.0
Critical headway, s:	5.0
Average time for left-turn vehicle to clear the advancing lane, s:	1.9



Left-Turn Lane Warrant Analysis

Project: 21029 - Autumn Sunrise
Intersection: SW Vermillion Drive/Site Access SW Norwood Road
Date: 6/30/2021
Scenario: 2026 Buildout - AM Peak Hour (EB)

2-lane roadway (English)

INPUT

Variable	Value
85 th percentile speed, mph:	45
Percent of left-turns in advancing volume (V_A), %:	20%
Advancing volume (V_A), veh/h:	107
Opposing volume (V_O), veh/h:	86

OUTPUT

Variable	Value
Limiting advancing volume (V_A), veh/h:	369
Guidance for determining the need for a major-road left-turn bay:	
Left-turn treatment NOT warranted.	

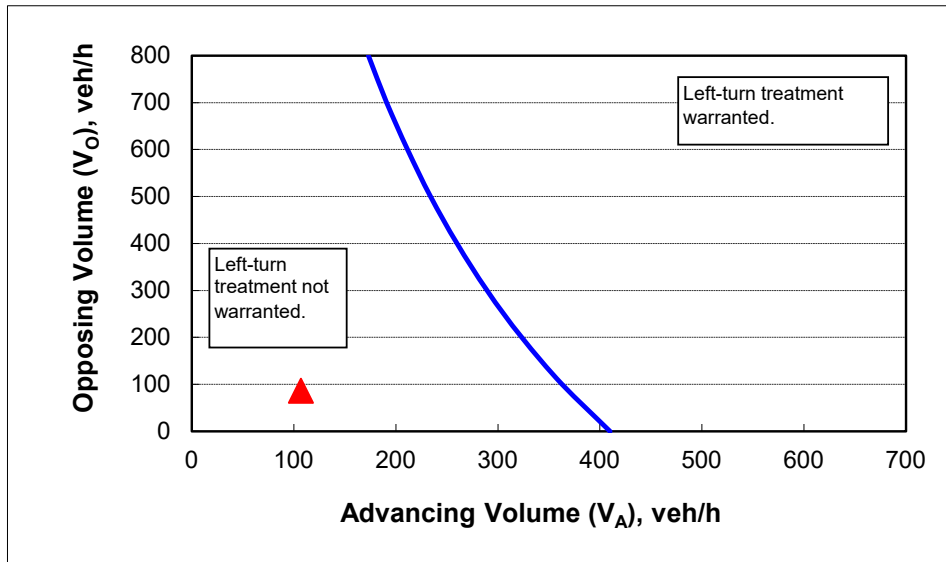

CALIBRATION CONSTANTS

Variable	Value
Average time for making left-turn, s:	3.0
Critical headway, s:	5.0
Average time for left-turn vehicle to clear the advancing lane, s:	1.9



Left-Turn Lane Warrant Analysis

Project: 21029 - Autumn Sunrise
 Intersection: SW Vermillion Drive/Site Access SW Norwood Road
 Date: 6/30/2021
 Scenario: 2026 Buildout - AM Peak Hour (WB)

2-lane roadway (English)

INPUT

Variable	Value
85 th percentile speed, mph:	45
Percent of left-turns in advancing volume (V_A), %:	9%
Advancing volume (V_A), veh/h:	94
Opposing volume (V_O), veh/h:	86

OUTPUT

Variable	Value
Limiting advancing volume (V_A), veh/h:	525
Guidance for determining the need for a major-road left-turn bay:	
Left-turn treatment NOT warranted.	

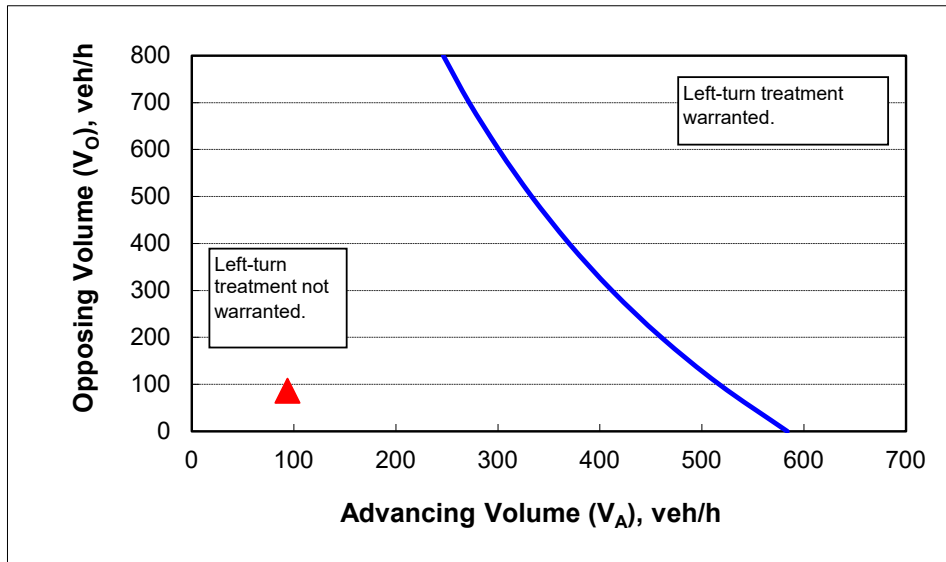

CALIBRATION CONSTANTS

Variable	Value
Average time for making left-turn, s:	3.0
Critical headway, s:	5.0
Average time for left-turn vehicle to clear the advancing lane, s:	1.9



Left-Turn Lane Warrant Analysis

Project: 21029 - Autumn Sunrise
 Intersection: SW Vermillion Drive/Site Access SW Norwood Road
 Date: 6/30/2021
 Scenario: 2026 Buildout - PM Peak Hour (EB)

2-lane roadway (English)

INPUT

Variable	Value
85 th percentile speed, mph:	45
Percent of left-turns in advancing volume (V_A), %:	29%
Advancing volume (V_A), veh/h:	243
Opposing volume (V_O), veh/h:	172

OUTPUT

Variable	Value
Limiting advancing volume (V_A), veh/h:	293
Guidance for determining the need for a major-road left-turn bay:	
Left-turn treatment NOT warranted.	

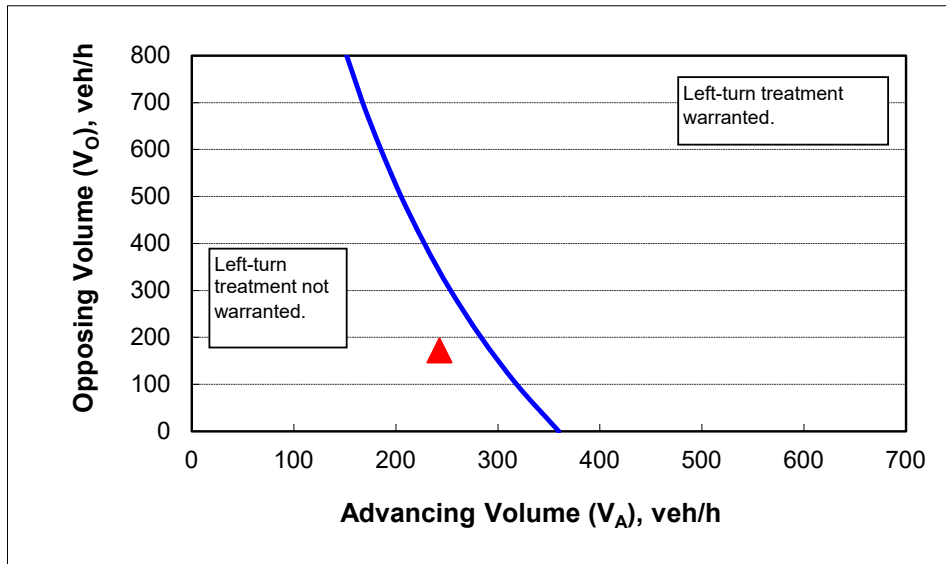

CALIBRATION CONSTANTS

Variable	Value
Average time for making left-turn, s:	3.0
Critical headway, s:	5.0
Average time for left-turn vehicle to clear the advancing lane, s:	1.9



Left-Turn Lane Warrant Analysis

Project: 21029 - Autumn Sunrise
 Intersection: SW Vermillion Drive/Site Access SW Norwood Road
 Date: 6/30/2021
 Scenario: 2026 Buildout - PM Peak Hour (WB)

2-lane roadway (English)

INPUT

Variable	Value
85 th percentile speed, mph:	45
Percent of left-turns in advancing volume (V_A), %:	13%
Advancing volume (V_A), veh/h:	198
Opposing volume (V_O), veh/h:	173

OUTPUT

Variable	Value
Limiting advancing volume (V_A), veh/h:	392
Guidance for determining the need for a major-road left-turn bay:	
Left-turn treatment NOT warranted.	

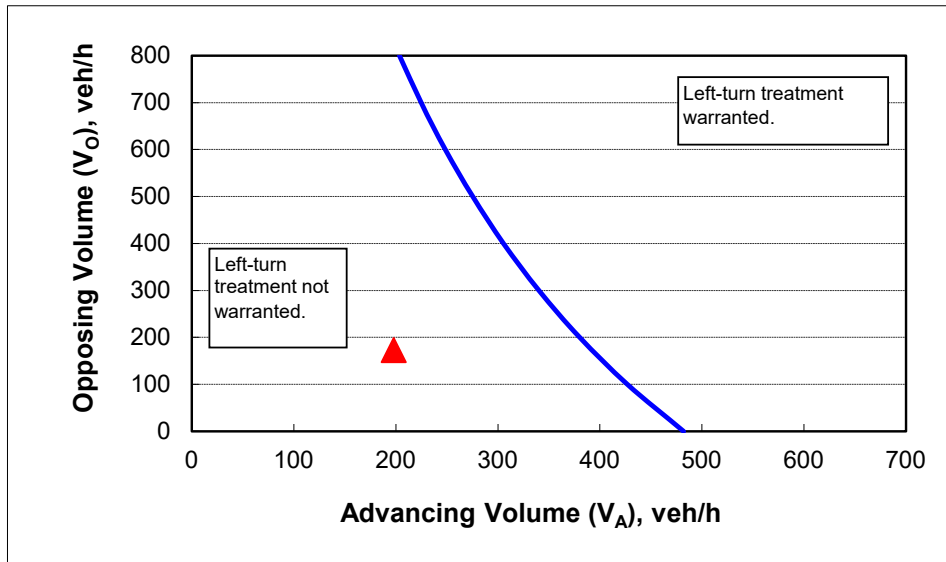

CALIBRATION CONSTANTS

Variable	Value
Average time for making left-turn, s:	3.0
Critical headway, s:	5.0
Average time for left-turn vehicle to clear the advancing lane, s:	1.9

Preliminary Right-Turn Lane Warrant Summary

Intersection	Warrant Met?
SW Boones Ferry Road/Site Access - Northbound	
2026 Buildout - Phases 1-4 - AM Peak Hour	Yes
2026 Buildout - Phases 1-4 - PM Peak Hour	Yes
SW 89th Avenue/Site Access/SW Norwood Road - Eastbound	
2024 Buildout - Phases 1-2 - AM Peak Hour	No
2024 Buildout - Phases 1-2 - PM Peak Hour	Yes
2026 Buildout - Phases 1-4 - AM Peak Hour	No
2026 Buildout - Phases 1-4 - PM Peak Hour	No
SW Vermillion Drive/Site Access/SW Norwood Road - Eastbound	
2024 Buildout - Phases 1-2 - AM Peak Hour	No
2024 Buildout - Phases 1-2 - PM Peak Hour	No
2026 Buildout - Phases 1-4 - AM Peak Hour	No
2026 Buildout - Phases 1-4 - PM Peak Hour	No



Project: 21029 - Autumn Sunrise
Intersection: SW Boones Ferry Road/Site Access - Northbound
Date: 6/30/2021
Scenario: 2026 Buildout - Phases 1-4

Speed? 45 mph 72 kmh

AM Peak Hour		PM Peak Hour	
Right-Turn Volume	32	Right-Turn Volume	104
Approaching DHV	709	Approaching DHV	725
Lane Needed?	Yes	Lane Needed?	Yes

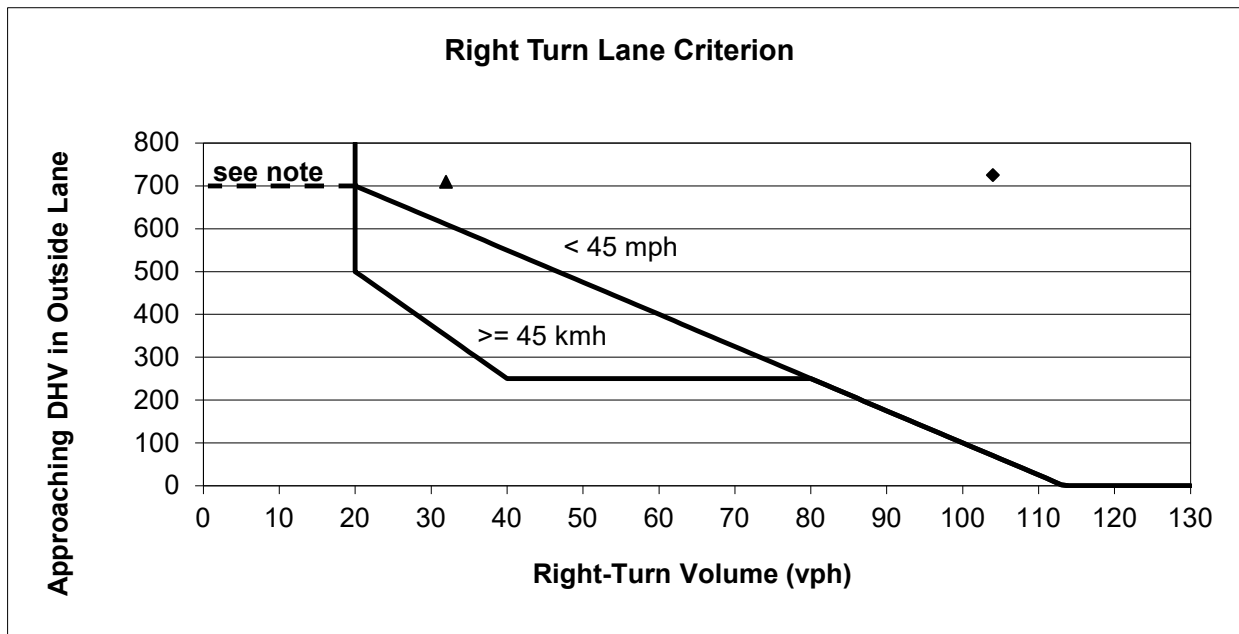

Note: If there is no right turn lane, a shoulder needs to be provided.
If this intersection is in a rural area and is a connection to a public street, a right turn lane is needed.



Project: 21029 - Autumn Sunrise
Intersection: SW 89th Avenue/Site Access/SW Norwood Road - Eastbound
Date: 6/30/2021
Scenario: 2024 Buildout - Phases 1-2

Speed? 45 mph 72 kmh

AM Peak Hour		PM Peak Hour	
Right-Turn Volume	11	Right-Turn Volume	38
Approaching DHV	112	Approaching DHV	303
Lane Needed?	No	Lane Needed?	Yes

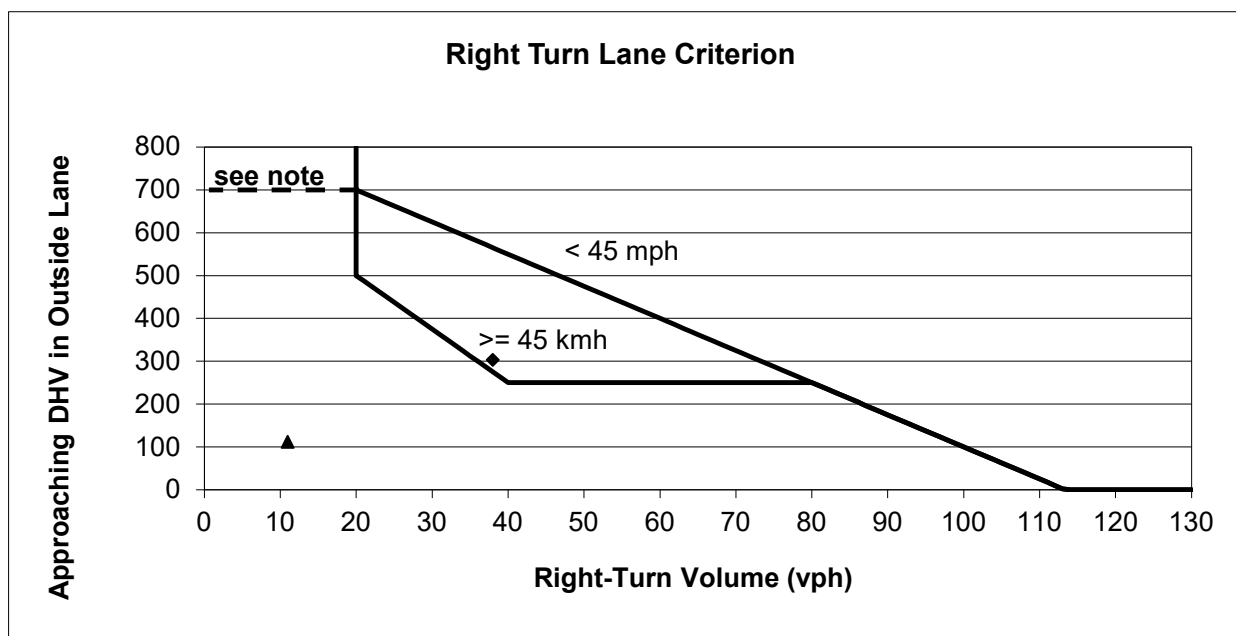

Note: If there is no right turn lane, a shoulder needs to be provided.
If this intersection is in a rural area and is a connection to a public street, a right turn lane is needed.



Project: 21029 - Autumn Sunrise
Intersection: SW 89th Avenue/Site Access/SW Norwood Road - Eastbound
Date: 6/30/2021
Scenario: 2026 Buildout - Phases 1-4

Speed? 45 mph 72 kmh

AM Peak Hour		PM Peak Hour	
Right-Turn Volume	7	Right-Turn Volume	23
Approaching DHV	110	Approaching DHV	293
Lane Needed?	No	Lane Needed?	No

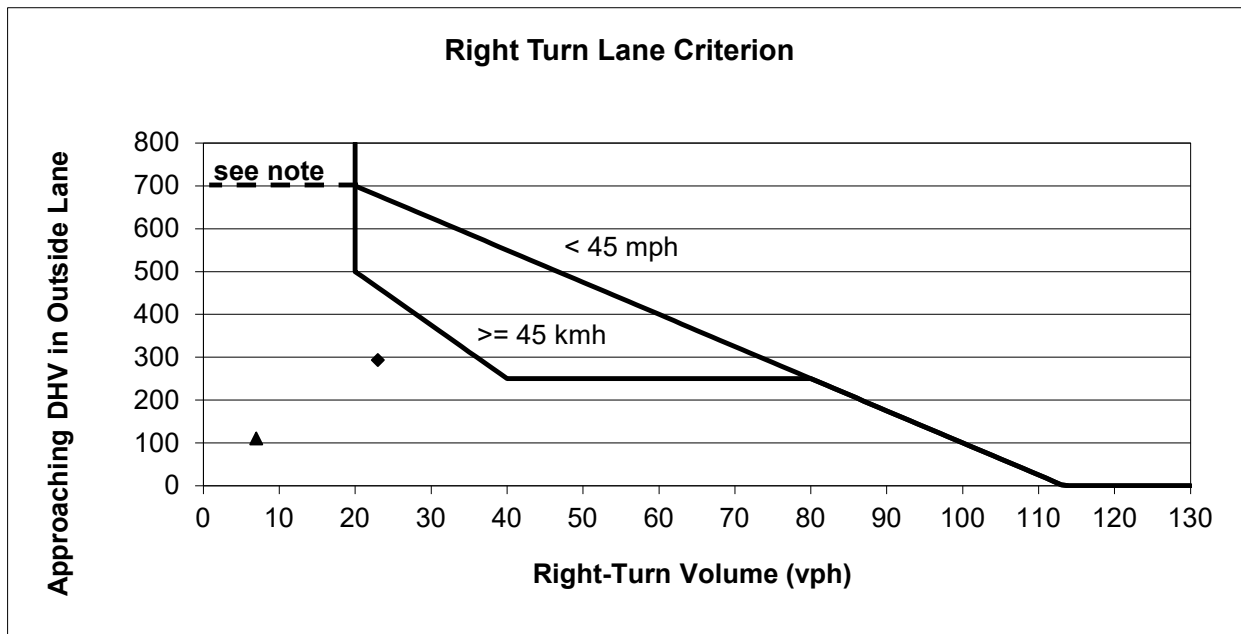

Note: If there is no right turn lane, a shoulder needs to be provided.
If this intersection is in a rural area and is a connection to a public street, a right turn lane is needed.



Project: 21029 - Autumn Sunrise
Intersection: SW Vermillion Drive/Site Access/SW Norwood Road - Eastbound
Date: 6/30/2021
Scenario: 2024 Buildout - Phases 1-2

Speed? 45 mph 72 kmh

AM Peak Hour		PM Peak Hour	
Right-Turn Volume	12	Right-Turn Volume	40
Approaching DHV	110	Approaching DHV	242
Lane Needed?	No	Lane Needed?	No

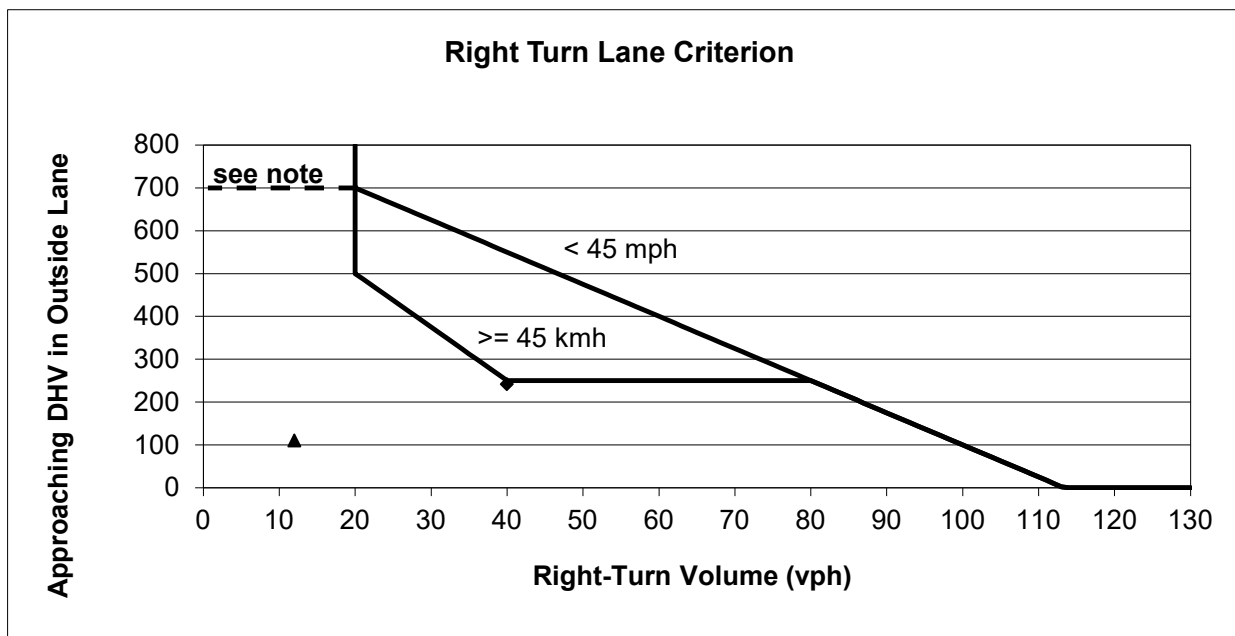

Note: If there is no right turn lane, a shoulder needs to be provided.
If this intersection is in a rural area and is a connection to a public street, a right turn lane is needed.



Project: 21029 - Autumn Sunrise
Intersection: SW Vermillion Drive/Site Access/SW Norwood Road - Eastbound
Date: 6/30/2021
Scenario: 2026 Buildout - Phases 1-4

Speed? 45 mph 72 kmh

AM Peak Hour		PM Peak Hour	
Right-Turn Volume	11	Right-Turn Volume	37
Approaching DHV	107	Approaching DHV	243
Lane Needed?	No	Lane Needed?	No

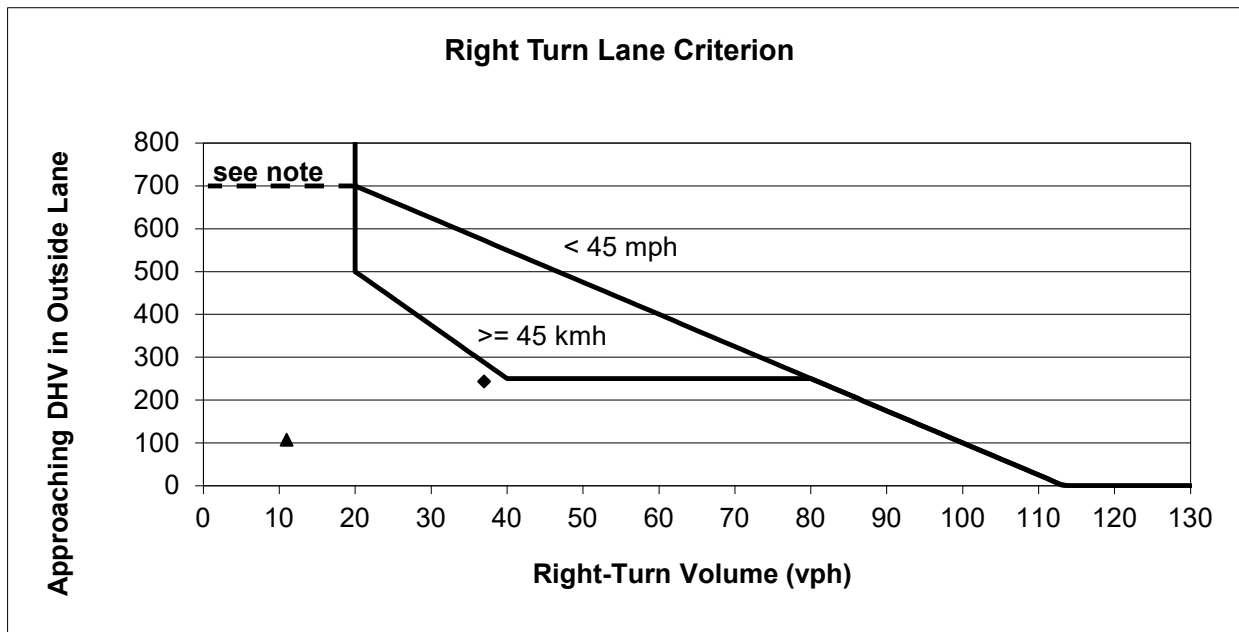

Note: If there is no right turn lane, a shoulder needs to be provided.
If this intersection is in a rural area and is a connection to a public street, a right turn lane is needed.

Preliminary Traffic Signal Warrant Summary



Intersection	Warrant Met?
SW Iowa Street at SW Boones Ferry Road	Based on AM
Year 2026 Phases 1-4 Conditions (Based on AM)	No
Year 2026 Phases 1-4 Conditions (Based on PM)	No
SW Norwood Road at SW Boones Ferry Road	
Year 2024 Phase 1-2 Conditions (Based on AM)	No
Year 2024 Phase 1-2 Conditions (Based on PM)	No
Year 2026 Phases 1-4 Conditions (Based on AM)	No
Year 2026 Phases 1-4 Conditions (Based on PM)	No
Site Access at SW Boones Ferry Road	
Year 2026 Phases 1-4 Conditions (Based on AM) w/ 2-lane Exit	No
Year 2026 Phases 1-4 Conditions (Based on PM) w/ 2-lane Exit	No
SW 89th Avenue/Site Access at SW Norwood Road	
Year 2024 Phase 1-2 Conditions (Based on AM)	No
Year 2024 Phase 1-2 Conditions (Based on PM)	No
Year 2026 Phases 1-4 Conditions (Based on AM)	No
Year 2026 Phases 1-4 Conditions (Based on PM)	No
SW Vermillion Drive/Site Access at SW Norwood Road	
Year 2024 Phase 1-2 Conditions (Based on AM)	No
Year 2024 Phase 1-2 Conditions (Based on PM)	No
Year 2026 Phases 1-4 Conditions (Based on AM)	No
Year 2026 Phases 1-4 Conditions (Based on PM)	No
SW 82nd Avenue at SW Norwood Road	
Year 2026 Phases 1-4 Conditions (Based on AM)	No
Year 2026 Phases 1-4 Conditions (Based on PM)	No
SW Norwood Road at SW 65th Avenue	
Year 2026 Phases 1-4 Conditions (Based on AM)	No
Year 2026 Phases 1-4 Conditions (Based on PM)	No



Preliminary Traffic Signal Warrant Analysis

Project: 21029 - Autumn Sunrise
 Date: 9/20/2021
 Scenario: Year 2026 Phases 1-4 Conditions (Based on AM)

Major Street:	SW Boones Ferry Road	Minor Street:	SW Iowa Street	
Number of Lanes:	1	Number of Lanes:	1	
AM Peak Hour Volumes:	1312	AM Peak Hour Volumes:	109	Total
			56	Rights
			50%	RT Discount

Warrant Used:

X 100 percent of standard warrants used
 70 percent of standard warrants used due to 85th percentile speed in excess of 40 mph or isolated community with population less than 10,000.

Number of Lanes for Moving Traffic on Each Approach:		ADT on Major St. (total of both approaches)		ADT on Minor St. (higher-volume approach)	
<u>Major St.</u>	<u>Minor St.</u>	<u>Warrants</u>	<u>Warrants</u>	<u>Warrants</u>	<u>Warrants</u>
<u>WARRANT 1, CONDITION A</u>					
		100%	70%	100%	70%
1	1	8,850	6,200	2,650	1,850
2 or more	1	10,600	7,400	2,650	1,850
2 or more	2 or more	10,600	7,400	3,550	2,500
1	2 or more	8,850	6,200	3,550	2,500
<u>WARRANT 1, CONDITION B</u>					
1	1	13,300	9,300	1,350	950
2 or more	1	15,900	11,100	1,350	950
2 or more	2 or more	15,900	11,100	1,750	1,250
1	2 or more	13,300	9,300	1,750	1,250

Note: ADT volumes assume 8th highest hour is 5.6% of the daily volume

	Approach Volumes	Minimum Volumes	Is Signal Warrant Met?
<i>Warrant 1</i>			
<i>Condition A: Minimum Vehicular Volume</i>			
Major Street	13,120	8,850	
Minor Street*	810	2,650	No
<i>Condition B: Interruption of Continuous Traffic</i>			
Major Street	13,120	13,300	
Minor Street*	810	1,350	No
<i>Combination Warrant</i>			
Major Street	13,120	10,640	
Minor Street*	810	2,120	No

* Minor street right-turning traffic volumes reduced by 50%.



Preliminary Traffic Signal Warrant Analysis

Project: 21029 - Autumn Sunrise
 Date: 9/20/2021
 Scenario: Year 2026 Phases 1-4 Conditions (Based on PM)

Major Street:	SW Boones Ferry Road	Minor Street:	SW Iowa Street	
Number of Lanes:	1	Number of Lanes:	1	
PM Peak Hour Volumes:	1637	PM Peak Hour Volumes:	72	Total
			35	Rights
			50%	RT Discount

Warrant Used:

X 100 percent of standard warrants used
 70 percent of standard warrants used due to 85th percentile speed in excess of 40 mph or isolated community with population less than 10,000.

Number of Lanes for Moving Traffic on Each Approach:		ADT on Major St. (total of both approaches)		ADT on Minor St. (higher-volume approach)	
<u>Major St.</u>	<u>Minor St.</u>	<u>Warrants</u>	<u>Warrants</u>	<u>Warrants</u>	<u>Warrants</u>
<u>WARRANT 1, CONDITION A</u>					
		100%	70%	100%	70%
1	1	8,850	6,200	2,650	1,850
2 or more	1	10,600	7,400	2,650	1,850
2 or more	2 or more	10,600	7,400	3,550	2,500
1	2 or more	8,850	6,200	3,550	2,500
<u>WARRANT 1, CONDITION B</u>					
1	1	13,300	9,300	1,350	950
2 or more	1	15,900	11,100	1,350	950
2 or more	2 or more	15,900	11,100	1,750	1,250
1	2 or more	13,300	9,300	1,750	1,250

Note: ADT volumes assume 8th highest hour is 5.6% of the daily volume

	Approach Volumes	Minimum Volumes	Is Signal Warrant Met?
<i>Warrant 1</i>			
<i>Condition A: Minimum Vehicular Volume</i>			
Major Street	16,370	8,850	
Minor Street*	550	2,650	No
<i>Condition B: Interruption of Continuous Traffic</i>			
Major Street	16,370	13,300	
Minor Street*	550	1,350	No
<i>Combination Warrant</i>			
Major Street	16,370	10,640	
Minor Street*	550	2,120	No

* Minor street right-turning traffic volumes reduced by 50%.



Preliminary Traffic Signal Warrant Analysis

Project: 21029 - Autumn Sunrise
 Date: 9/20/2021
 Scenario: Year 2024 Phase 1-2 Conditions (Based on AM)

Major Street:	SW Boones Ferry Road	Minor Street:	SW Norwood Road	
Number of Lanes:	1	Number of Lanes:	1	
AM Peak Hour Volumes:	1206	AM Peak Hour Volumes:	205	Total Rights RT Discount
			91	
			50%	

Warrant Used:

 X 100 percent of standard warrants used
 70 percent of standard warrants used due to 85th percentile speed in excess of 40 mph or isolated community with population less than 10,000.

Number of Lanes for Moving Traffic on Each Approach:		ADT on Major St. (total of both approaches)		ADT on Minor St. (higher-volume approach)	
<u>Major St.</u>	<u>Minor St.</u>	<u>Warrants</u>	<u>Warrants</u>	<u>Warrants</u>	<u>Warrants</u>
<u>WARRANT 1, CONDITION A</u>					
		100%	70%	100%	70%
1	1	8,850	6,200	2,650	1,850
2 or more	1	10,600	7,400	2,650	1,850
2 or more	2 or more	10,600	7,400	3,550	2,500
1	2 or more	8,850	6,200	3,550	2,500
<u>WARRANT 1, CONDITION B</u>					
1	1	13,300	9,300	1,350	950
2 or more	1	15,900	11,100	1,350	950
2 or more	2 or more	15,900	11,100	1,750	1,250
1	2 or more	13,300	9,300	1,750	1,250

Note: ADT volumes assume 8th highest hour is 5.6% of the daily volume

	Approach Volumes	Minimum Volumes	Is Signal Warrant Met?
<i>Warrant 1</i>			
<i>Condition A: Minimum Vehicular Volume</i>			
Major Street	12,060	8,850	
Minor Street*	1,600	2,650	No
<i>Condition B: Interruption of Continuous Traffic</i>			
Major Street	12,060	13,300	
Minor Street*	1,600	1,350	No
<i>Combination Warrant</i>			
Major Street	12,060	10,640	
Minor Street*	1,600	2,120	No

* Minor street right-turning traffic volumes reduced by 50%.



Preliminary Traffic Signal Warrant Analysis

Project: 21029 - Autumn Sunrise
 Date: 9/20/2021
 Scenario: Year 2024 Phase 1-2 Conditions (Based on PM)

Major Street:	SW Boones Ferry Road	Minor Street:	SW Norwood Road	
Number of Lanes:	1	Number of Lanes:	1	
			166	Total
PM Peak		PM Peak	98	Rights
Hour Volumes:	1500	Hour Volumes:	50%	RT Discount

Warrant Used:

 X 100 percent of standard warrants used
 70 percent of standard warrants used due to 85th percentile speed in excess
 of 40 mph or isolated community with population less than 10,000.

Number of Lanes for Moving Traffic on Each Approach:		ADT on Major St. (total of both approaches)		ADT on Minor St. (higher-volume approach)	
<u>Major St.</u>	<u>Minor St.</u>	<u>Warrants</u>	<u>Warrants</u>	<u>Warrants</u>	<u>Warrants</u>
<u>WARRANT 1, CONDITION A</u>					
		100%	70%	100%	70%
1	1	8,850	6,200	2,650	1,850
2 or more	1	10,600	7,400	2,650	1,850
2 or more	2 or more	10,600	7,400	3,550	2,500
1	2 or more	8,850	6,200	3,550	2,500
<u>WARRANT 1, CONDITION B</u>					
1	1	13,300	9,300	1,350	950
2 or more	1	15,900	11,100	1,350	950
2 or more	2 or more	15,900	11,100	1,750	1,250
1	2 or more	13,300	9,300	1,750	1,250

Note: ADT volumes assume 8th highest hour is 5.6% of the daily volume

	Approach Volumes	Minimum Volumes	Is Signal Warrant Met?
<i>Warrant 1</i>			
<i>Condition A: Minimum Vehicular Volume</i>			
Major Street	15,000	8,850	
Minor Street*	1,170	2,650	No
<i>Condition B: Interruption of Continuous Traffic</i>			
Major Street	15,000	13,300	
Minor Street*	1,170	1,350	No
<i>Combination Warrant</i>			
Major Street	15,000	10,640	
Minor Street*	1,170	2,120	No

* Minor street right-turning traffic volumes reduced by 50%.



Preliminary Traffic Signal Warrant Analysis

Project: 21029 - Autumn Sunrise
 Date: 9/20/2021
 Scenario: Year 2026 Phases 1-4 Conditions (Based on AM)

Major Street:	SW Boones Ferry Road	Minor Street:	SW Norwood Road	
Number of Lanes:	1	Number of Lanes:	1	
AM Peak Hour Volumes:	1299	AM Peak Hour Volumes:	191	Total
			102	Rights
			50%	RT Discount

Warrant Used:

 X 100 percent of standard warrants used
 70 percent of standard warrants used due to 85th percentile speed in excess
 of 40 mph or isolated community with population less than 10,000.

Number of Lanes for Moving Traffic on Each Approach:		ADT on Major St. (total of both approaches)		ADT on Minor St. (higher-volume approach)	
<u>Major St.</u>	<u>Minor St.</u>	<u>Warrants</u>	<u>Warrants</u>	<u>Warrants</u>	<u>Warrants</u>
<u>WARRANT 1, CONDITION A</u>					
		100%	70%	100%	70%
1	1	8,850	6,200	2,650	1,850
2 or more	1	10,600	7,400	2,650	1,850
2 or more	2 or more	10,600	7,400	3,550	2,500
1	2 or more	8,850	6,200	3,550	2,500
<u>WARRANT 1, CONDITION B</u>					
1	1	13,300	9,300	1,350	950
2 or more	1	15,900	11,100	1,350	950
2 or more	2 or more	15,900	11,100	1,750	1,250
1	2 or more	13,300	9,300	1,750	1,250

Note: ADT volumes assume 8th highest hour is 5.6% of the daily volume

	Approach Volumes	Minimum Volumes	Is Signal Warrant Met?
<i>Warrant 1</i>			
<i>Condition A: Minimum Vehicular Volume</i>			
Major Street	12,990	8,850	
Minor Street*	1,400	2,650	No
<i>Condition B: Interruption of Continuous Traffic</i>			
Major Street	12,990	13,300	
Minor Street*	1,400	1,350	No
<i>Combination Warrant</i>			
Major Street	12,990	10,640	
Minor Street*	1,400	2,120	No

* Minor street right-turning traffic volumes reduced by 50%.



Preliminary Traffic Signal Warrant Analysis

Project: 21029 - Autumn Sunrise
 Date: 9/20/2021
 Scenario: Year 2026 Phases 1-4 Conditions (Based on PM)

Major Street:	SW Boones Ferry Road	Minor Street:	SW Norwood Road	
Number of Lanes:	1	Number of Lanes:	1	
PM Peak Hour Volumes:	1607	PM Peak Hour Volumes:	158	Total Rights RT Discount
			106	
			50%	

Warrant Used:

 X 100 percent of standard warrants used
 70 percent of standard warrants used due to 85th percentile speed in excess of 40 mph or isolated community with population less than 10,000.

Number of Lanes for Moving Traffic on Each Approach:		ADT on Major St. (total of both approaches)		ADT on Minor St. (higher-volume approach)	
<u>Major St.</u>	<u>Minor St.</u>	<u>Warrants</u>	<u>Warrants</u>	<u>Warrants</u>	<u>Warrants</u>
<u>WARRANT 1, CONDITION A</u>					
		100%	70%	100%	70%
1	1	8,850	6,200	2,650	1,850
2 or more	1	10,600	7,400	2,650	1,850
2 or more	2 or more	10,600	7,400	3,550	2,500
1	2 or more	8,850	6,200	3,550	2,500
<u>WARRANT 1, CONDITION B</u>					
1	1	13,300	9,300	1,350	950
2 or more	1	15,900	11,100	1,350	950
2 or more	2 or more	15,900	11,100	1,750	1,250
1	2 or more	13,300	9,300	1,750	1,250

Note: ADT volumes assume 8th highest hour is 5.6% of the daily volume

	Approach Volumes	Minimum Volumes	Is Signal Warrant Met?
<i>Warrant 1</i>			
<i>Condition A: Minimum Vehicular Volume</i>			
Major Street	16,070	8,850	
Minor Street*	1,050	2,650	No
<i>Condition B: Interruption of Continuous Traffic</i>			
Major Street	16,070	13,300	
Minor Street*	1,050	1,350	No
<i>Combination Warrant</i>			
Major Street	16,070	10,640	
Minor Street*	1,050	2,120	No

* Minor street right-turning traffic volumes reduced by 50%.



Preliminary Traffic Signal Warrant Analysis

Project: 21029 - Autumn Sunrise
 Date: 9/20/2021
 Scenario: Year 2026 Phases 1-4 Conditions (Based on AM) w/ 2-lane Exit

Major Street:	SW Boones Ferry Road	Minor Street:	Site Access	
Number of Lanes:	1	Number of Lanes:	1	
AM Peak Hour Volumes:	1300	AM Peak Hour Volumes:	154	Total
			58	Rights
			100%	RT Discount

Warrant Used:

 X 100 percent of standard warrants used
 70 percent of standard warrants used due to 85th percentile speed in excess of 40 mph or isolated community with population less than 10,000.

Number of Lanes for Moving Traffic on Each Approach:		ADT on Major St. (total of both approaches)		ADT on Minor St. (higher-volume approach)	
<u>Major St.</u>	<u>Minor St.</u>	<u>Warrants</u>	<u>Warrants</u>	<u>Warrants</u>	<u>Warrants</u>
<u>WARRANT 1, CONDITION A</u>					
1	1	8,850	6,200	2,650	1,850
2 or more	1	10,600	7,400	2,650	1,850
2 or more	2 or more	10,600	7,400	3,550	2,500
1	2 or more	8,850	6,200	3,550	2,500
<u>WARRANT 1, CONDITION B</u>					
1	1	13,300	9,300	1,350	950
2 or more	1	15,900	11,100	1,350	950
2 or more	2 or more	15,900	11,100	1,750	1,250
1	2 or more	13,300	9,300	1,750	1,250

Note: ADT volumes assume 8th highest hour is 5.6% of the daily volume

	Approach Volumes	Minimum Volumes	Is Signal Warrant Met?
<i>Warrant 1</i>			
<i>Condition A: Minimum Vehicular Volume</i>			
Major Street	13,000	8,850	
Minor Street*	960	2,650	No
<i>Condition B: Interruption of Continuous Traffic</i>			
Major Street	13,000	13,300	
Minor Street*	960	1,350	No
<i>Combination Warrant</i>			
Major Street	13,000	10,640	
Minor Street*	960	2,120	No

* Minor street right-turning traffic volumes reduced by 100%.



Preliminary Traffic Signal Warrant Analysis

Project: 21029 - Autumn Sunrise
 Date: 9/20/2021
 Scenario: Year 2026 Phases 1-4 Conditions (Based on PM) w/ 2-lane Exit

Major Street:	SW Boones Ferry Road	Minor Street:	Site Access	
Number of Lanes:	1	Number of Lanes:	1	
PM Peak Hour Volumes:	1591	PM Peak Hour Volumes:	100	Total Rights RT Discount
			38	
			100%	

Warrant Used:

 X 100 percent of standard warrants used
 70 percent of standard warrants used due to 85th percentile speed in excess of 40 mph or isolated community with population less than 10,000.

Number of Lanes for Moving Traffic on Each Approach:		ADT on Major St. (total of both approaches)		ADT on Minor St. (higher-volume approach)	
<u>Major St.</u>	<u>Minor St.</u>	<u>Warrants</u>	<u>Warrants</u>	<u>Warrants</u>	<u>Warrants</u>
<u>WARRANT 1, CONDITION A</u>					
1	1	8,850	6,200	2,650	1,850
2 or more	1	10,600	7,400	2,650	1,850
2 or more	2 or more	10,600	7,400	3,550	2,500
1	2 or more	8,850	6,200	3,550	2,500
<u>WARRANT 1, CONDITION B</u>					
1	1	13,300	9,300	1,350	950
2 or more	1	15,900	11,100	1,350	950
2 or more	2 or more	15,900	11,100	1,750	1,250
1	2 or more	13,300	9,300	1,750	1,250

Note: ADT volumes assume 8th highest hour is 5.6% of the daily volume

	Approach Volumes	Minimum Volumes	Is Signal Warrant Met?
<i>Warrant 1</i>			
<i>Condition A: Minimum Vehicular Volume</i>			
Major Street	15,910	8,850	
Minor Street*	620	2,650	No
<i>Condition B: Interruption of Continuous Traffic</i>			
Major Street	15,910	13,300	
Minor Street*	620	1,350	No
<i>Combination Warrant</i>			
Major Street	15,910	10,640	
Minor Street*	620	2,120	No

* Minor street right-turning traffic volumes reduced by 100%.



Preliminary Traffic Signal Warrant Analysis

Project: 21029 - Autumn Sunrise
 Date: 9/20/2021
 Scenario: Year 2024 Phase 1-2 Conditions (Based on AM)

Major Street:	SW Norwood Road	Minor Street:	SW 89th Avenue/Site Access	
Number of Lanes:	1	Number of Lanes:	1	
AM Peak Hour Volumes:	329	AM Peak Hour Volumes:	43	Total
			25	Rights
			50%	RT Discount

Warrant Used:

 X 100 percent of standard warrants used
 70 percent of standard warrants used due to 85th percentile speed in excess of 40 mph or isolated community with population less than 10,000.

Number of Lanes for Moving Traffic on Each Approach:		ADT on Major St. (total of both approaches)		ADT on Minor St. (higher-volume approach)	
<u>Major St.</u>	<u>Minor St.</u>	<u>Warrants</u>	<u>Warrants</u>	<u>Warrants</u>	<u>Warrants</u>
<u>WARRANT 1, CONDITION A</u>					
		100%	70%	100%	70%
1	1	8,850	6,200	2,650	1,850
2 or more	1	10,600	7,400	2,650	1,850
2 or more	2 or more	10,600	7,400	3,550	2,500
1	2 or more	8,850	6,200	3,550	2,500
<u>WARRANT 1, CONDITION B</u>					
1	1	13,300	9,300	1,350	950
2 or more	1	15,900	11,100	1,350	950
2 or more	2 or more	15,900	11,100	1,750	1,250
1	2 or more	13,300	9,300	1,750	1,250

Note: ADT volumes assume 8th highest hour is 5.6% of the daily volume

	Approach Volumes	Minimum Volumes	Is Signal Warrant Met?
<i>Warrant 1</i>			
<i>Condition A: Minimum Vehicular Volume</i>			
Major Street	3,290	8,850	
Minor Street*	310	2,650	No
<i>Condition B: Interruption of Continuous Traffic</i>			
Major Street	3,290	13,300	
Minor Street*	310	1,350	No
<i>Combination Warrant</i>			
Major Street	3,290	10,640	
Minor Street*	310	2,120	No

* Minor street right-turning traffic volumes reduced by 50%.



Preliminary Traffic Signal Warrant Analysis

Project: 21029 - Autumn Sunrise
 Date: 9/20/2021
 Scenario: Year 2024 Phase 1-2 Conditions (Based on PM)

Major Street:	SW Norwood Road	Minor Street:	SW 89th Avenue/Site Access	
Number of Lanes:	1	Number of Lanes:	1	
			27	Total
PM Peak		PM Peak	5	Rights
Hour Volumes:	495	Hour Volumes:	50%	RT Discount

Warrant Used:

 X 100 percent of standard warrants used
 70 percent of standard warrants used due to 85th percentile speed in excess
 of 40 mph or isolated community with population less than 10,000.

Number of Lanes for Moving Traffic on Each Approach:		ADT on Major St. (total of both approaches)		ADT on Minor St. (higher-volume approach)	
<u>Major St.</u>	<u>Minor St.</u>	<u>Warrants</u>	<u>Warrants</u>	<u>Warrants</u>	<u>Warrants</u>
<u>WARRANT 1, CONDITION A</u>					
		100%	70%	100%	70%
1	1	8,850	6,200	2,650	1,850
2 or more	1	10,600	7,400	2,650	1,850
2 or more	2 or more	10,600	7,400	3,550	2,500
1	2 or more	8,850	6,200	3,550	2,500
<u>WARRANT 1, CONDITION B</u>					
1	1	13,300	9,300	1,350	950
2 or more	1	15,900	11,100	1,350	950
2 or more	2 or more	15,900	11,100	1,750	1,250
1	2 or more	13,300	9,300	1,750	1,250

Note: ADT volumes assume 8th highest hour is 5.6% of the daily volume

	Approach Volumes	Minimum Volumes	Is Signal Warrant Met?
<i>Warrant 1</i>			
<i>Condition A: Minimum Vehicular Volume</i>			
Major Street	4,950	8,850	
Minor Street*	250	2,650	No
<i>Condition B: Interruption of Continuous Traffic</i>			
Major Street	4,950	13,300	
Minor Street*	250	1,350	No
<i>Combination Warrant</i>			
Major Street	4,950	10,640	
Minor Street*	250	2,120	No

* Minor street right-turning traffic volumes reduced by 50%.



Preliminary Traffic Signal Warrant Analysis

Project: 21029 - Autumn Sunrise
 Date: 9/20/2021
 Scenario: Year 2026 Phases 1-4 Conditions (Based on AM)

Major Street:	SW Norwood Road	Minor Street:	SW 89th Avenue/Site Access	
Number of Lanes:	1	Number of Lanes:	1	
AM Peak Hour Volumes:	324	AM Peak Hour Volumes:	45	Total
			26	Rights
			50%	RT Discount

Warrant Used:

 X 100 percent of standard warrants used
 70 percent of standard warrants used due to 85th percentile speed in excess
 of 40 mph or isolated community with population less than 10,000.

Number of Lanes for Moving Traffic on Each Approach:		ADT on Major St. (total of both approaches)		ADT on Minor St. (higher-volume approach)	
<u>Major St.</u>	<u>Minor St.</u>	<u>Warrants</u>	<u>Warrants</u>	<u>Warrants</u>	<u>Warrants</u>
<u>WARRANT 1, CONDITION A</u>					
		100%	70%	100%	70%
1	1	8,850	6,200	2,650	1,850
2 or more	1	10,600	7,400	2,650	1,850
2 or more	2 or more	10,600	7,400	3,550	2,500
1	2 or more	8,850	6,200	3,550	2,500
<u>WARRANT 1, CONDITION B</u>					
1	1	13,300	9,300	1,350	950
2 or more	1	15,900	11,100	1,350	950
2 or more	2 or more	15,900	11,100	1,750	1,250
1	2 or more	13,300	9,300	1,750	1,250

Note: ADT volumes assume 8th highest hour is 5.6% of the daily volume

	Approach Volumes	Minimum Volumes	Is Signal Warrant Met?
<i>Warrant 1</i>			
<i>Condition A: Minimum Vehicular Volume</i>			
Major Street	3,240	8,850	
Minor Street*	320	2,650	No
<i>Condition B: Interruption of Continuous Traffic</i>			
Major Street	3,240	13,300	
Minor Street*	320	1,350	No
<i>Combination Warrant</i>			
Major Street	3,240	10,640	
Minor Street*	320	2,120	No

* Minor street right-turning traffic volumes reduced by 50%.



Preliminary Traffic Signal Warrant Analysis

Project: 21029 - Autumn Sunrise
 Date: 9/20/2021
 Scenario: Year 2026 Phases 1-4 Conditions (Based on PM)

Major Street:	SW Norwood Road	Minor Street:	SW 89th Avenue/Site Access	
Number of Lanes:	1	Number of Lanes:	1	
			20	Total
PM Peak		PM Peak	9	Rights
Hour Volumes:	482	Hour Volumes:	50%	RT Discount

Warrant Used:

 X 100 percent of standard warrants used
 70 percent of standard warrants used due to 85th percentile speed in excess
 of 40 mph or isolated community with population less than 10,000.

Number of Lanes for Moving Traffic on Each Approach:		ADT on Major St. (total of both approaches)		ADT on Minor St. (higher-volume approach)	
<u>Major St.</u>	<u>Minor St.</u>	<u>Warrants</u>	<u>Warrants</u>	<u>Warrants</u>	<u>Warrants</u>
<u>WARRANT 1, CONDITION A</u>					
		100%	70%	100%	70%
1	1	8,850	6,200	2,650	1,850
2 or more	1	10,600	7,400	2,650	1,850
2 or more	2 or more	10,600	7,400	3,550	2,500
1	2 or more	8,850	6,200	3,550	2,500
<u>WARRANT 1, CONDITION B</u>					
1	1	13,300	9,300	1,350	950
2 or more	1	15,900	11,100	1,350	950
2 or more	2 or more	15,900	11,100	1,750	1,250
1	2 or more	13,300	9,300	1,750	1,250

Note: ADT volumes assume 8th highest hour is 5.6% of the daily volume

	Approach Volumes	Minimum Volumes	Is Signal Warrant Met?
<i>Warrant 1</i>			
<i>Condition A: Minimum Vehicular Volume</i>			
Major Street	4,820	8,850	
Minor Street*	160	2,650	No
<i>Condition B: Interruption of Continuous Traffic</i>			
Major Street	4,820	13,300	
Minor Street*	160	1,350	No
<i>Combination Warrant</i>			
Major Street	4,820	10,640	
Minor Street*	160	2,120	No

* Minor street right-turning traffic volumes reduced by 50%.



Preliminary Traffic Signal Warrant Analysis

Project: 21029 - Autumn Sunrise
 Date: 9/20/2021
 Scenario: Year 2024 Phase 1-2 Conditions (Based on AM)

Major Street:	SW Norwood Road	Minor Street:	SW Vermillion Drive/Site Access	
Number of Lanes:	1	Number of Lanes:	1	
AM Peak Hour Volumes:	256	AM Peak Hour Volumes:	81	Total Rights RT Discount
			43	
			50%	

Warrant Used:

 X 100 percent of standard warrants used
 70 percent of standard warrants used due to 85th percentile speed in excess of 40 mph or isolated community with population less than 10,000.

Number of Lanes for Moving Traffic on Each Approach:		ADT on Major St. (total of both approaches)		ADT on Minor St. (higher-volume approach)	
<u>Major St.</u>	<u>Minor St.</u>	<u>Warrants</u>	<u>Warrants</u>	<u>Warrants</u>	<u>Warrants</u>
<u>WARRANT 1, CONDITION A</u>					
1	1	8,850	6,200	2,650	1,850
2 or more	1	10,600	7,400	2,650	1,850
2 or more	2 or more	10,600	7,400	3,550	2,500
1	2 or more	8,850	6,200	3,550	2,500
<u>WARRANT 1, CONDITION B</u>					
1	1	13,300	9,300	1,350	950
2 or more	1	15,900	11,100	1,350	950
2 or more	2 or more	15,900	11,100	1,750	1,250
1	2 or more	13,300	9,300	1,750	1,250

Note: ADT volumes assume 8th highest hour is 5.6% of the daily volume

	Approach Volumes	Minimum Volumes	Is Signal Warrant Met?
<i>Warrant 1</i>			
<i>Condition A: Minimum Vehicular Volume</i>			
Major Street	2,560	8,850	
Minor Street*	600	2,650	No
<i>Condition B: Interruption of Continuous Traffic</i>			
Major Street	2,560	13,300	
Minor Street*	600	1,350	No
<i>Combination Warrant</i>			
Major Street	2,560	10,640	
Minor Street*	600	2,120	No

* Minor street right-turning traffic volumes reduced by 50%.



Preliminary Traffic Signal Warrant Analysis

Project: 21029 - Autumn Sunrise
 Date: 9/20/2021
 Scenario: Year 2024 Phase 1-2 Conditions (Based on PM)

Major Street:	SW Norwood Road	Minor Street:	SW Vermillion Drive/Site Access	
Number of Lanes:	1	Number of Lanes:	1	
PM Peak Hour Volumes:	424	PM Peak Hour Volumes:	59	Total
			36	Rights
			50%	RT Discount

Warrant Used:

 X 100 percent of standard warrants used
 70 percent of standard warrants used due to 85th percentile speed in excess of 40 mph or isolated community with population less than 10,000.

Number of Lanes for Moving Traffic on Each Approach:		ADT on Major St. (total of both approaches)		ADT on Minor St. (higher-volume approach)	
<u>Major St.</u>	<u>Minor St.</u>	<u>Warrants</u>	<u>Warrants</u>	<u>Warrants</u>	<u>Warrants</u>
<u>WARRANT 1, CONDITION A</u>					
		100%	70%	100%	70%
1	1	8,850	6,200	2,650	1,850
2 or more	1	10,600	7,400	2,650	1,850
2 or more	2 or more	10,600	7,400	3,550	2,500
1	2 or more	8,850	6,200	3,550	2,500
<u>WARRANT 1, CONDITION B</u>					
1	1	13,300	9,300	1,350	950
2 or more	1	15,900	11,100	1,350	950
2 or more	2 or more	15,900	11,100	1,750	1,250
1	2 or more	13,300	9,300	1,750	1,250

Note: ADT volumes assume 8th highest hour is 5.6% of the daily volume

	Approach Volumes	Minimum Volumes	Is Signal Warrant Met?
<i>Warrant 1</i>			
<i>Condition A: Minimum Vehicular Volume</i>			
Major Street	4,240	8,850	
Minor Street*	410	2,650	No
<i>Condition B: Interruption of Continuous Traffic</i>			
Major Street	4,240	13,300	
Minor Street*	410	1,350	No
<i>Combination Warrant</i>			
Major Street	4,240	10,640	
Minor Street*	410	2,120	No

* Minor street right-turning traffic volumes reduced by 50%.



Preliminary Traffic Signal Warrant Analysis

Project: 21029 - Autumn Sunrise
 Date: 9/20/2021
 Scenario: Year 2026 Phases 1-4 Conditions (Based on AM)

Major Street:	SW Norwood Road	Minor Street:	SW Vermillion Drive/Site Access	
Number of Lanes:	1	Number of Lanes:	1	
AM Peak Hour Volumes:	264	AM Peak Hour Volumes:	85	Total Rights RT Discount
			43	
			50%	

Warrant Used:

 X 100 percent of standard warrants used
 70 percent of standard warrants used due to 85th percentile speed in excess of 40 mph or isolated community with population less than 10,000.

Number of Lanes for Moving Traffic on Each Approach:		ADT on Major St. (total of both approaches)		ADT on Minor St. (higher-volume approach)	
<u>Major St.</u>	<u>Minor St.</u>	<u>Warrants</u>	<u>Warrants</u>	<u>Warrants</u>	<u>Warrants</u>
<u>WARRANT 1, CONDITION A</u>					
		100%	70%	100%	70%
1	1	8,850	6,200	2,650	1,850
2 or more	1	10,600	7,400	2,650	1,850
2 or more	2 or more	10,600	7,400	3,550	2,500
1	2 or more	8,850	6,200	3,550	2,500
<u>WARRANT 1, CONDITION B</u>					
1	1	13,300	9,300	1,350	950
2 or more	1	15,900	11,100	1,350	950
2 or more	2 or more	15,900	11,100	1,750	1,250
1	2 or more	13,300	9,300	1,750	1,250

Note: ADT volumes assume 8th highest hour is 5.6% of the daily volume

	Approach Volumes	Minimum Volumes	Is Signal Warrant Met?
<i>Warrant 1</i>			
<i>Condition A: Minimum Vehicular Volume</i>			
Major Street	2,640	8,850	
Minor Street*	640	2,650	No
<i>Condition B: Interruption of Continuous Traffic</i>			
Major Street	2,640	13,300	
Minor Street*	640	1,350	No
<i>Combination Warrant</i>			
Major Street	2,640	10,640	
Minor Street*	640	2,120	No

* Minor street right-turning traffic volumes reduced by 50%.



Preliminary Traffic Signal Warrant Analysis

Project: 21029 - Autumn Sunrise
 Date: 9/20/2021
 Scenario: Year 2026 Phases 1-4 Conditions (Based on PM)

Major Street:	SW Norwood Road	Minor Street:	SW Vermillion Drive/Site Access	
Number of Lanes:	1	Number of Lanes:	1	
PM Peak Hour Volumes:	447	PM Peak Hour Volumes:	61	Total Rights RT Discount
			37	
			50%	

Warrant Used:

 X 100 percent of standard warrants used
 70 percent of standard warrants used due to 85th percentile speed in excess of 40 mph or isolated community with population less than 10,000.

Number of Lanes for Moving Traffic on Each Approach:		ADT on Major St. (total of both approaches)		ADT on Minor St. (higher-volume approach)	
<u>Major St.</u>	<u>Minor St.</u>	<u>Warrants</u>	<u>Warrants</u>	<u>Warrants</u>	<u>Warrants</u>
<u>WARRANT 1, CONDITION A</u>					
		100%	70%	100%	70%
1	1	8,850	6,200	2,650	1,850
2 or more	1	10,600	7,400	2,650	1,850
2 or more	2 or more	10,600	7,400	3,550	2,500
1	2 or more	8,850	6,200	3,550	2,500
<u>WARRANT 1, CONDITION B</u>					
1	1	13,300	9,300	1,350	950
2 or more	1	15,900	11,100	1,350	950
2 or more	2 or more	15,900	11,100	1,750	1,250
1	2 or more	13,300	9,300	1,750	1,250

Note: ADT volumes assume 8th highest hour is 5.6% of the daily volume

	Approach Volumes	Minimum Volumes	Is Signal Warrant Met?
<i>Warrant 1</i>			
<i>Condition A: Minimum Vehicular Volume</i>			
Major Street	4,470	8,850	
Minor Street*	430	2,650	No
<i>Condition B: Interruption of Continuous Traffic</i>			
Major Street	4,470	13,300	
Minor Street*	430	1,350	No
<i>Combination Warrant</i>			
Major Street	4,470	10,640	
Minor Street*	430	2,120	No

* Minor street right-turning traffic volumes reduced by 50%.



Preliminary Traffic Signal Warrant Analysis

Project: 21029 - Autumn Sunrise
 Date: 9/20/2021
 Scenario: Year 2026 Phases 1-4 Conditions (Based on AM)

Major Street:	SW Norwood Road	Minor Street:	SW 82nd Avenue	
Number of Lanes:	1	Number of Lanes:	1	
AM Peak Hour Volumes:	177	AM Peak Hour Volumes:	84	Total Rights RT Discount
			84	
			50%	

Warrant Used:

 X 100 percent of standard warrants used
 70 percent of standard warrants used due to 85th percentile speed in excess of 40 mph or isolated community with population less than 10,000.

Number of Lanes for Moving Traffic on Each Approach:		ADT on Major St. (total of both approaches)		ADT on Minor St. (higher-volume approach)	
<u>Major St.</u>	<u>Minor St.</u>	<u>Warrants</u>	<u>Warrants</u>	<u>Warrants</u>	<u>Warrants</u>
<u>WARRANT 1, CONDITION A</u>					
1	1	8,850	6,200	2,650	1,850
2 or more	1	10,600	7,400	2,650	1,850
2 or more	2 or more	10,600	7,400	3,550	2,500
1	2 or more	8,850	6,200	3,550	2,500
<u>WARRANT 1, CONDITION B</u>					
1	1	13,300	9,300	1,350	950
2 or more	1	15,900	11,100	1,350	950
2 or more	2 or more	15,900	11,100	1,750	1,250
1	2 or more	13,300	9,300	1,750	1,250

Note: ADT volumes assume 8th highest hour is 5.6% of the daily volume

	Approach Volumes	Minimum Volumes	Is Signal Warrant Met?
<i>Warrant 1</i>			
<i>Condition A: Minimum Vehicular Volume</i>			
Major Street	1,770	8,850	
Minor Street*	420	2,650	No
<i>Condition B: Interruption of Continuous Traffic</i>			
Major Street	1,770	13,300	
Minor Street*	420	1,350	No
<i>Combination Warrant</i>			
Major Street	1,770	10,640	
Minor Street*	420	2,120	No

* Minor street right-turning traffic volumes reduced by 50%.



Preliminary Traffic Signal Warrant Analysis

Project: 21029 - Autumn Sunrise
 Date: 9/20/2021
 Scenario: Year 2026 Phases 1-4 Conditions (Based on PM)

Major Street:	SW Norwood Road	Minor Street:	SW 82nd Avenue	
Number of Lanes:	1	Number of Lanes:	1	
PM Peak Hour Volumes:	186	PM Peak Hour Volumes:	181	Total
			175	Rights
			50%	RT Discount

Warrant Used:

 X 100 percent of standard warrants used
 70 percent of standard warrants used due to 85th percentile speed in excess of 40 mph or isolated community with population less than 10,000.

Number of Lanes for Moving Traffic on Each Approach:		ADT on Major St. (total of both approaches)		ADT on Minor St. (higher-volume approach)	
<u>Major St.</u>	<u>Minor St.</u>	<u>Warrants</u>	<u>Warrants</u>	<u>Warrants</u>	<u>Warrants</u>
<u>WARRANT 1, CONDITION A</u>					
		100%	70%	100%	70%
1	1	8,850	6,200	2,650	1,850
2 or more	1	10,600	7,400	2,650	1,850
2 or more	2 or more	10,600	7,400	3,550	2,500
1	2 or more	8,850	6,200	3,550	2,500
<u>WARRANT 1, CONDITION B</u>					
1	1	13,300	9,300	1,350	950
2 or more	1	15,900	11,100	1,350	950
2 or more	2 or more	15,900	11,100	1,750	1,250
1	2 or more	13,300	9,300	1,750	1,250

Note: ADT volumes assume 8th highest hour is 5.6% of the daily volume

	Approach Volumes	Minimum Volumes	Is Signal Warrant Met?
<i>Warrant 1</i>			
<i>Condition A: Minimum Vehicular Volume</i>			
Major Street	1,860	8,850	
Minor Street*	940	2,650	No
<i>Condition B: Interruption of Continuous Traffic</i>			
Major Street	1,860	13,300	
Minor Street*	940	1,350	No
<i>Combination Warrant</i>			
Major Street	1,860	10,640	
Minor Street*	940	2,120	No

* Minor street right-turning traffic volumes reduced by 50%.



Preliminary Traffic Signal Warrant Analysis

Project: 21029 - Autumn Sunrise
 Date: 9/20/2021
 Scenario: Year 2026 Phases 1-4 Conditions (Based on AM)

Major Street:	SW 65th Avenue	Minor Street:	SW Norwood Road	
Number of Lanes:	1	Number of Lanes:	1	
AM Peak Hour Volumes:	706	AM Peak Hour Volumes:	216	Total Rights RT Discount
			62	
			50%	

Warrant Used:

 X 100 percent of standard warrants used
 70 percent of standard warrants used due to 85th percentile speed in excess of 40 mph or isolated community with population less than 10,000.

Number of Lanes for Moving Traffic on Each Approach:		ADT on Major St. (total of both approaches)		ADT on Minor St. (higher-volume approach)	
<u>Major St.</u>	<u>Minor St.</u>	<u>Warrants</u>	<u>Warrants</u>	<u>Warrants</u>	<u>Warrants</u>
<u>WARRANT 1, CONDITION A</u>					
		100%	70%	100%	70%
1	1	8,850	6,200	2,650	1,850
2 or more	1	10,600	7,400	2,650	1,850
2 or more	2 or more	10,600	7,400	3,550	2,500
1	2 or more	8,850	6,200	3,550	2,500
<u>WARRANT 1, CONDITION B</u>					
1	1	13,300	9,300	1,350	950
2 or more	1	15,900	11,100	1,350	950
2 or more	2 or more	15,900	11,100	1,750	1,250
1	2 or more	13,300	9,300	1,750	1,250

Note: ADT volumes assume 8th highest hour is 5.6% of the daily volume

	Approach Volumes	Minimum Volumes	Is Signal Warrant Met?
<i>Warrant 1</i>			
<i>Condition A: Minimum Vehicular Volume</i>			
Major Street	7,060	8,850	
Minor Street*	1,850	2,650	No
<i>Condition B: Interruption of Continuous Traffic</i>			
Major Street	7,060	13,300	
Minor Street*	1,850	1,350	No
<i>Combination Warrant</i>			
Major Street	7,060	10,640	
Minor Street*	1,850	2,120	No

* Minor street right-turning traffic volumes reduced by 50%.



Preliminary Traffic Signal Warrant Analysis

Project: 21029 - Autumn Sunrise
 Date: 9/20/2021
 Scenario: Year 2026 Phases 1-4 Conditions (Based on PM)

Major Street:	SW 65th Avenue	Minor Street:	SW Norwood Road	
Number of Lanes:	1	Number of Lanes:	1	
			154	Total
PM Peak		PM Peak	72	Rights
Hour Volumes:	834	Hour Volumes:	50%	RT Discount

Warrant Used:

 X 100 percent of standard warrants used
 70 percent of standard warrants used due to 85th percentile speed in excess
 of 40 mph or isolated community with population less than 10,000.

Number of Lanes for Moving Traffic on Each Approach:		ADT on Major St. (total of both approaches)		ADT on Minor St. (higher-volume approach)	
<u>Major St.</u>	<u>Minor St.</u>	<u>Warrants</u>	<u>Warrants</u>	<u>Warrants</u>	<u>Warrants</u>
<u>WARRANT 1, CONDITION A</u>					
		100%	70%	100%	70%
1	1	8,850	6,200	2,650	1,850
2 or more	1	10,600	7,400	2,650	1,850
2 or more	2 or more	10,600	7,400	3,550	2,500
1	2 or more	8,850	6,200	3,550	2,500
<u>WARRANT 1, CONDITION B</u>					
1	1	13,300	9,300	1,350	950
2 or more	1	15,900	11,100	1,350	950
2 or more	2 or more	15,900	11,100	1,750	1,250
1	2 or more	13,300	9,300	1,750	1,250

Note: ADT volumes assume 8th highest hour is 5.6% of the daily volume

	Approach Volumes	Minimum Volumes	Is Signal Warrant Met?
<i>Warrant 1</i>			
<i>Condition A: Minimum Vehicular Volume</i>			
Major Street	8,340	8,850	
Minor Street*	1,180	2,650	No
<i>Condition B: Interruption of Continuous Traffic</i>			
Major Street	8,340	13,300	
Minor Street*	1,180	1,350	No
<i>Combination Warrant</i>			
Major Street	8,340	10,640	
Minor Street*	1,180	2,120	No

* Minor street right-turning traffic volumes reduced by 50%.

Appendix D - Operations

Level of Service Definitions

Synchro Reports

HCM6 V/C Ratio Calculations

Queuing at Site Access





Level of Service Definitions

Level of service is used to describe the quality of traffic flow. Levels of service A to C are considered good, and rural roads are usually designed for level of service C. Urban streets and signalized intersections are typically designed for level of service D. Level of service E is considered to be the limit of acceptable delay. For unsignalized intersections, level of service E is generally considered acceptable. Here is a more complete description of levels of service:

- *Level of service A:* Very low delay at intersections, with all traffic signal cycles clearing and no vehicles waiting through more than one signal cycle. On highways, low volume and high speeds, with speeds not restricted by other vehicles.
- *Level of service B:* Operating speeds beginning to be affected by other traffic; short traffic delays at intersections. Higher average intersection delay than for level of service A resulting from more vehicles stopping.
- *Level of service C:* Operating speeds and maneuverability closely controlled by other traffic; higher delays at intersections than for level of service B due to a significant number of vehicles stopping. Not all signal cycles clear the waiting vehicles. This is the recommended design standard for rural highways.
- *Level of service D:* Tolerable operating speeds; long traffic delays occur at intersections. The influence of congestion is noticeable. At traffic signals many vehicles stop, and the proportion of vehicles not stopping declines. The number of signal cycle failures, for which vehicles must wait through more than one signal cycle, are noticeable. This is typically the design level for urban signalized intersections.
- *Level of service E:* Restricted speeds, very long traffic delays at traffic signals, and traffic volumes near capacity. Flow is unstable so that any interruption, no matter how minor, will cause queues to form and service to deteriorate to level of service F. Traffic signal cycle failures are frequent occurrences. For unsignalized intersections, level of service E or better is generally considered acceptable.
- *Level of service F:* Extreme delays, resulting in long queues which may interfere with other traffic movements. There may be stoppages of long duration, and speeds may drop to zero. There may be frequent signal cycle failures. Level of service F will typically result when vehicle arrival rates are greater than capacity. It is considered unacceptable by most drivers.



Level of Service Criteria
For Signalized Intersections

Level of Service (LOS)	Control Delay per Vehicle (Seconds)
A	<10
B	10-20
C	20-35
D	35-55
E	55-80
F	>80

Level of Service Criteria
For Unsignalized Intersections

Level of Service (LOS)	Control Delay per Vehicle (Seconds)
A	<10
B	10-15
C	15-25
D	25-35
E	35-50
F	>50

HCM 6th Signalized Intersection Summary
 1: SW Boones Ferry Rd & SW Sagert St

06/24/2021



Movement	EBL	EBT	EBR	WBL	WBT	WBR	NBL	NBT	NBR	SBL	SBT	SBR
Lane Configurations												
Traffic Volume (veh/h)	66	73	11	166	93	57	7	554	261	48	253	44
Future Volume (veh/h)	66	73	11	166	93	57	7	554	261	48	253	44
Initial Q (Qb), veh	0	0	0	0	0	0	0	0	0	0	0	0
Ped-Bike Adj(A_pbT)	1.00		0.99	1.00		1.00	1.00		0.98	1.00		0.98
Parking Bus, Adj	1.00	1.00	1.00	1.00	1.00	1.00	1.00	1.00	1.00	1.00	1.00	1.00
Work Zone On Approach		No			No			No			No	
Adj Sat Flow, veh/h/ln	1885	1885	1885	1900	1900	1900	1885	1885	1885	1811	1811	1811
Adj Flow Rate, veh/h	73	80	7	182	102	41	8	609	271	53	278	32
Peak Hour Factor	0.91	0.91	0.91	0.91	0.91	0.91	0.91	0.91	0.91	0.91	0.91	0.91
Percent Heavy Veh, %	1	1	1	0	0	0	1	1	1	6	6	6
Cap, veh/h	265	135	12	338	179	72	678	700	311	252	1091	904
Arrive On Green	0.06	0.08	0.07	0.12	0.14	0.13	0.02	0.57	0.56	0.05	0.60	0.60
Sat Flow, veh/h	1795	1708	149	1810	1287	517	1795	1226	546	1725	1811	1501
Grp Volume(v), veh/h	73	0	87	182	0	143	8	0	880	53	278	32
Grp Sat Flow(s),veh/h/ln	1795	0	1857	1810	0	1805	1795	0	1772	1725	1811	1501
Q Serve(g_s), s	3.1	0.0	3.9	7.5	0.0	6.3	0.2	0.0	36.3	1.0	6.2	0.7
Cycle Q Clear(g_c), s	3.1	0.0	3.9	7.5	0.0	6.3	0.2	0.0	36.3	1.0	6.2	0.7
Prop In Lane	1.00		0.08	1.00		0.29	1.00		0.31	1.00		1.00
Lane Grp Cap(c), veh/h	265	0	146	338	0	251	678	0	1011	252	1091	904
V/C Ratio(X)	0.28	0.00	0.59	0.54	0.00	0.57	0.01	0.00	0.87	0.21	0.25	0.04
Avail Cap(c_a), veh/h	396	0	348	362	0	338	880	0	1162	392	1187	984
HCM Platoon Ratio	1.00	1.00	1.00	1.00	1.00	1.00	1.00	1.00	1.00	1.00	1.00	1.00
Upstream Filter(I)	1.00	0.00	1.00	1.00	0.00	1.00	1.00	0.00	1.00	1.00	1.00	1.00
Uniform Delay (d), s/veh	33.4	0.0	38.0	29.3	0.0	34.5	7.6	0.0	15.8	15.1	8.0	6.9
Incr Delay (d2), s/veh	0.2	0.0	1.4	0.5	0.0	0.8	0.0	0.0	7.4	0.2	0.2	0.0
Initial Q Delay(d3),s/veh	0.0	0.0	0.0	0.0	0.0	0.0	0.0	0.0	0.0	0.0	0.0	0.0
%ile BackOfQ(50%),veh/ln	1.4	0.0	1.8	3.2	0.0	2.8	0.1	0.0	14.9	0.4	2.2	0.2
Unsig. Movement Delay, s/veh												
LnGrp Delay(d),s/veh	33.6	0.0	39.5	29.8	0.0	35.2	7.6	0.0	23.2	15.3	8.2	6.9
LnGrp LOS	C	A	D	C	A	D	A	A	C	B	A	A
Approach Vol, veh/h		160			325			888			363	
Approach Delay, s/veh		36.8			32.2			23.0			9.1	
Approach LOS		D			C			C			A	
Timer - Assigned Phs	1	2	3	4	5	6	7	8				
Phs Duration (G+Y+Rc), s	8.1	52.7	13.9	10.7	5.4	55.4	8.7	15.9				
Change Period (Y+Rc), s	4.5	5.0	4.5	4.5	4.5	5.0	4.5	4.5				
Max Green Setting (Gmax), s	10.5	55.0	10.5	15.5	10.5	55.0	10.5	15.5				
Max Q Clear Time (g_c+I1), s	3.0	38.3	9.5	5.9	2.2	8.2	5.1	8.3				
Green Ext Time (p_c), s	0.0	9.5	0.0	0.1	0.0	3.4	0.0	0.2				

Intersection Summary

HCM 6th Ctrl Delay	23.1
HCM 6th LOS	C

Notes

User approved pedestrian interval to be less than phase max green.

HCM 6th Signalized Intersection Summary

2: SW Boones Ferry Rd & SW Avery St

06/24/2021



Movement	EBL	EBT	EBR	WBL	WBT	WBR	NBL	NBT	NBR	SBL	SBT	SBR
Lane Configurations												
Traffic Volume (veh/h)	162	64	133	28	97	14	236	646	38	6	279	145
Future Volume (veh/h)	162	64	133	28	97	14	236	646	38	6	279	145
Initial Q (Qb), veh	0	0	0	0	0	0	0	0	0	0	0	0
Ped-Bike Adj(A_pbT)	0.99		0.97	0.99		0.96	1.00		0.98	1.00		1.00
Parking Bus, Adj	1.00	1.00	1.00	1.00	1.00	1.00	1.00	1.00	1.00	1.00	1.00	1.00
Work Zone On Approach		No			No			No			No	
Adj Sat Flow, veh/h/ln	1841	1841	1841	1841	1841	1841	1767	1767	1767	1841	1841	1841
Adj Flow Rate, veh/h	193	76	87	33	115	11	281	769	39	7	332	155
Peak Hour Factor	0.84	0.84	0.84	0.84	0.84	0.84	0.84	0.84	0.84	0.84	0.84	0.84
Percent Heavy Veh, %	4	4	4	4	4	4	9	9	9	4	4	4
Cap, veh/h	346	155	177	270	192	18	464	914	46	204	526	246
Arrive On Green	0.12	0.20	0.19	0.03	0.12	0.10	0.11	0.55	0.53	0.01	0.44	0.44
Sat Flow, veh/h	1753	769	881	1753	1647	158	1682	1665	84	1753	1185	553
Grp Volume(v), veh/h	193	0	163	33	0	126	281	0	808	7	0	487
Grp Sat Flow(s),veh/h/ln	1753	0	1650	1753	0	1805	1682	0	1749	1753	0	1739
Q Serve(g_s), s	7.2	0.0	6.8	1.3	0.0	5.1	6.7	0.0	29.8	0.2	0.0	16.6
Cycle Q Clear(g_c), s	7.2	0.0	6.8	1.3	0.0	5.1	6.7	0.0	29.8	0.2	0.0	16.6
Prop In Lane	1.00		0.53	1.00		0.09	1.00		0.05	1.00		0.32
Lane Grp Cap(c), veh/h	346	0	332	270	0	210	464	0	960	204	0	772
V/C Ratio(X)	0.56	0.00	0.49	0.12	0.00	0.60	0.61	0.00	0.84	0.03	0.00	0.63
Avail Cap(c_a), veh/h	390	0	332	463	0	422	513	0	1272	324	0	1265
HCM Platoon Ratio	1.00	1.00	1.00	1.00	1.00	1.00	1.00	1.00	1.00	1.00	1.00	1.00
Upstream Filter(I)	1.00	0.00	1.00	1.00	0.00	1.00	1.00	0.00	1.00	1.00	0.00	1.00
Uniform Delay (d), s/veh	24.9	0.0	27.5	29.3	0.0	32.3	12.1	0.0	14.6	15.5	0.0	16.5
Incr Delay (d2), s/veh	0.5	0.0	0.4	0.1	0.0	1.0	1.0	0.0	4.6	0.0	0.0	1.2
Initial Q Delay(d3),s/veh	0.0	0.0	0.0	0.0	0.0	0.0	0.0	0.0	0.0	0.0	0.0	0.0
%ile BackOfQ(50%),veh/ln	2.9	0.0	2.6	0.5	0.0	2.2	2.3	0.0	11.4	0.1	0.0	6.3
Unsig. Movement Delay, s/veh												
LnGrp Delay(d),s/veh	25.4	0.0	27.9	29.3	0.0	33.4	13.1	0.0	19.2	15.5	0.0	17.7
LnGrp LOS	C	A	C	C	A	C	B	A	B	B	A	B
Approach Vol, veh/h		356			159			1089			494	
Approach Delay, s/veh		26.6			32.5			17.6			17.7	
Approach LOS		C			C			B			B	
Timer - Assigned Phs	1	2	3	4	5	6	7	8				
Phs Duration (G+Y+Rc), s	4.7	46.3	6.5	19.5	12.8	38.2	13.1	13.0				
Change Period (Y+Rc), s	4.0	5.5	4.0	5.0	4.0	5.5	4.0	5.0				
Max Green Setting (Gmax), s	6.0	54.5	11.0	12.0	11.0	54.5	11.0	17.0				
Max Q Clear Time (g_c+1/2), s	12.2	31.8	3.3	8.8	8.7	18.6	9.2	7.1				
Green Ext Time (p_c), s	0.0	8.9	0.0	0.2	0.1	5.3	0.0	0.3				

Intersection Summary

HCM 6th Ctrl Delay	20.3
HCM 6th LOS	C

Notes

User approved pedestrian interval to be less than phase max green.

HCM 6th Signalized Intersection Summary
 3: SW Boones Ferry Road & SW Ibach Street/SW Ibach Court

06/24/2021



Movement	EBL	EBT	EBR	WBL	WBT	WBR	NBL	NBT	NBR	SBL	SBT	SBR
Lane Configurations												
Traffic Volume (veh/h)	238	4	312	4	1	17	122	665	9	3	358	79
Future Volume (veh/h)	238	4	312	4	1	17	122	665	9	3	358	79
Initial Q (Qb), veh	0	0	0	0	0	0	0	0	0	0	0	0
Ped-Bike Adj(A_pbT)	0.98		0.99	0.99		0.97	1.00		0.99	1.00		0.99
Parking Bus, Adj	1.00	1.00	1.00	1.00	1.00	1.00	1.00	1.00	1.00	1.00	1.00	1.00
Work Zone On Approach		No			No			No			No	
Adj Sat Flow, veh/h/ln	1856	1856	1856	1900	1900	1900	1796	1796	1796	1811	1811	1811
Adj Flow Rate, veh/h	274	5	198	5	1	14	140	764	10	3	411	51
Peak Hour Factor	0.87	0.87	0.87	0.87	0.87	0.87	0.87	0.87	0.87	0.87	0.87	0.87
Percent Heavy Veh, %	3	3	3	0	0	0	7	7	7	6	6	6
Cap, veh/h	442	10	415	126	54	262	176	961	13	6	803	677
Arrive On Green	0.27	0.27	0.26	0.26	0.27	0.26	0.10	0.54	0.53	0.00	0.44	0.44
Sat Flow, veh/h	1353	39	1525	214	199	963	1711	1769	23	1725	1811	1526
Grp Volume(v), veh/h	274	0	203	20	0	0	140	0	774	3	411	51
Grp Sat Flow(s),veh/h/ln	1353	0	1564	1376	0	0	1711	0	1792	1725	1811	1526
Q Serve(g_s), s	7.1	0.0	7.2	0.0	0.0	0.0	5.3	0.0	23.0	0.1	10.8	1.3
Cycle Q Clear(g_c), s	14.4	0.0	7.2	7.2	0.0	0.0	5.3	0.0	23.0	0.1	10.8	1.3
Prop In Lane	1.00		0.98	0.25		0.70	1.00		0.01	1.00		1.00
Lane Grp Cap(c), veh/h	442	0	426	432	0	0	176	0	973	6	803	677
V/C Ratio(X)	0.62	0.00	0.48	0.05	0.00	0.00	0.80	0.00	0.80	0.54	0.51	0.08
Avail Cap(c_a), veh/h	605	0	615	531	0	0	285	0	1517	287	1533	1292
HCM Platoon Ratio	1.00	1.00	1.00	1.00	1.00	1.00	1.00	1.00	1.00	1.00	1.00	1.00
Upstream Filter(l)	1.00	0.00	1.00	1.00	0.00	0.00	1.00	0.00	1.00	1.00	1.00	1.00
Uniform Delay (d), s/veh	23.2	0.0	20.4	17.9	0.0	0.0	29.0	0.0	12.2	32.9	13.2	10.6
Incr Delay (d2), s/veh	0.9	0.0	0.5	0.0	0.0	0.0	5.0	0.0	2.5	41.0	0.8	0.1
Initial Q Delay(d3),s/veh	0.0	0.0	0.0	0.0	0.0	0.0	0.0	0.0	0.0	0.0	0.0	0.0
%ile BackOfQ(50%),veh/ln	3.9	0.0	2.5	0.2	0.0	0.0	2.3	0.0	7.9	0.1	4.0	0.4
Unsig. Movement Delay, s/veh												
LnGrp Delay(d),s/veh	24.1	0.0	20.9	18.0	0.0	0.0	34.0	0.0	14.6	73.9	14.0	10.7
LnGrp LOS	C	A	C	B	A	A	C	A	B	E	B	B
Approach Vol, veh/h		477			20			914			465	
Approach Delay, s/veh		22.7			18.0			17.6			14.1	
Approach LOS		C			B			B			B	
Timer - Assigned Phs	1	2		4	5	6		8				
Phs Duration (G+Y+Rc), s	4.2	39.9		22.0	10.8	33.3		22.0				
Change Period (Y+Rc), s	4.0	5.0		4.5	4.0	5.0		4.5				
Max Green Setting (Gmax), s	1.0	55.0		25.5	11.0	55.0		22.0				
Max Q Clear Time (g_c+1/2t), s	1.0	25.0		16.4	7.3	12.8		9.2				
Green Ext Time (p_c), s	0.0	9.9		1.1	0.1	4.8		0.0				

Intersection Summary

HCM 6th Ctrl Delay	18.0
HCM 6th LOS	B

HCM 6th TWSC
4: SW Boones Ferry Road & SW Iowa Drive

06/24/2021

Intersection												
Int Delay, s/veh	6											
Movement	EBL	EBT	EBR	WBL	WBT	WBR	NBL	NBT	NBR	SBL	SBT	SBR
Lane Configurations		↕			↕		↕	↕		↕	↕	
Traffic Vol, veh/h	46	2	51	27	0	29	13	612	9	18	411	16
Future Vol, veh/h	46	2	51	27	0	29	13	612	9	18	411	16
Conflicting Peds, #/hr	13	0	5	1	0	9	5	0	1	9	0	13
Sign Control	Stop	Stop	Stop	Stop	Stop	Stop	Free	Free	Free	Free	Free	Free
RT Channelized	-	-	None	-	-	None	-	-	None	-	-	None
Storage Length	-	-	-	-	-	-	95	-	-	105	-	-
Veh in Median Storage, #	-	0	-	-	0	-	-	0	-	-	0	-
Grade, %	-	0	-	-	0	-	-	0	-	-	0	-
Peak Hour Factor	84	84	84	84	84	84	84	84	84	84	84	84
Heavy Vehicles, %	0	0	0	0	0	0	7	7	7	6	6	6
Mvmt Flow	55	2	61	32	0	35	15	729	11	21	489	19

Major/Minor	Minor2		Minor1		Major1			Major2				
Conflicting Flow All	1349	1333	517	1351	1337	757	521	0	0	749	0	0
Stage 1	554	554	-	774	774	-	-	-	-	-	-	-
Stage 2	795	779	-	577	563	-	-	-	-	-	-	-
Critical Hdwy	7.1	6.5	6.2	7.1	6.5	6.2	4.17	-	-	4.16	-	-
Critical Hdwy Stg 1	6.1	5.5	-	6.1	5.5	-	-	-	-	-	-	-
Critical Hdwy Stg 2	6.1	5.5	-	6.1	5.5	-	-	-	-	-	-	-
Follow-up Hdwy	3.5	4	3.3	3.5	4	3.3	2.263	-	-	2.254	-	-
Pot Cap-1 Maneuver	129	155	562	129	155	411	1020	-	-	842	-	-
Stage 1	520	517	-	394	411	-	-	-	-	-	-	-
Stage 2	384	409	-	506	512	-	-	-	-	-	-	-
Platoon blocked, %								-	-	-	-	-
Mov Cap-1 Maneuver	112	146	552	108	146	402	1007	-	-	835	-	-
Mov Cap-2 Maneuver	112	146	-	108	146	-	-	-	-	-	-	-
Stage 1	506	498	-	385	401	-	-	-	-	-	-	-
Stage 2	342	399	-	435	493	-	-	-	-	-	-	-

Approach	EB		WB		NB		SB	
HCM Control Delay, s	49.7		38		0.2		0.4	
HCM LOS	E		E					

Minor Lane/Major Mvmt	NBL	NBT	NBR	EBLn1WBLn1	SBL	SBT	SBR
Capacity (veh/h)	1007	-	-	192	174	835	-
HCM Lane V/C Ratio	0.015	-	-	0.614	0.383	0.026	-
HCM Control Delay (s)	8.6	-	-	49.7	38	9.4	-
HCM Lane LOS	A	-	-	E	E	A	-
HCM 95th %tile Q(veh)	0	-	-	3.5	1.7	0.1	-

HCM 6th TWSC
5: SW Boones Ferry Road & SW Norwood Road

06/24/2021

Intersection						
Int Delay, s/veh	2.6					
Movement	WBL	WBR	NBT	NBR	SBL	SBT
Lane Configurations	Y		↑	↑	↑	↑
Traffic Vol, veh/h	70	55	579	28	48	441
Future Vol, veh/h	70	55	579	28	48	441
Conflicting Peds, #/hr	4	4	0	4	4	0
Sign Control	Stop	Stop	Free	Free	Free	Free
RT Channelized	-	None	-	None	-	None
Storage Length	-	-	-	65	290	-
Veh in Median Storage, #	0	-	0	-	-	0
Grade, %	0	-	0	-	-	0
Peak Hour Factor	87	87	87	87	87	87
Heavy Vehicles, %	2	2	6	6	5	5
Mvmt Flow	80	63	666	32	55	507

Major/Minor	Minor1	Major1	Major2			
Conflicting Flow All	1291	674	0	0	702	0
Stage 1	670	-	-	-	-	-
Stage 2	621	-	-	-	-	-
Critical Hdwy	6.42	6.22	-	-	4.15	-
Critical Hdwy Stg 1	5.42	-	-	-	-	-
Critical Hdwy Stg 2	5.42	-	-	-	-	-
Follow-up Hdwy	3.518	3.318	-	-	2.245	-
Pot Cap-1 Maneuver	180	455	-	-	882	-
Stage 1	509	-	-	-	-	-
Stage 2	536	-	-	-	-	-
Platoon blocked, %			-	-		
Mov Cap-1 Maneuver	167	452	-	-	879	-
Mov Cap-2 Maneuver	306	-	-	-	-	-
Stage 1	507	-	-	-	-	-
Stage 2	500	-	-	-	-	-

Approach	WB	NB	SB
HCM Control Delay, s	21.7	0	0.9
HCM LOS	C		

Minor Lane/Major Mvmt	NBT	NBRWBLn1	SBL	SBT
Capacity (veh/h)	-	-	357	879
HCM Lane V/C Ratio	-	-	0.402	0.063
HCM Control Delay (s)	-	-	21.7	9.4
HCM Lane LOS	-	-	C	A
HCM 95th %tile Q(veh)	-	-	1.9	0.2

HCM 6th TWSC
7: SW Boones Ferry Road & SW Greenhill Lane

06/24/2021

Intersection						
Int Delay, s/veh	0					
Movement	WBL	WBR	NBT	NBR	SBL	SBT
Lane Configurations	↔		↔		↔	↔
Traffic Vol, veh/h	2	1	609	0	0	512
Future Vol, veh/h	2	1	609	0	0	512
Conflicting Peds, #/hr	4	4	0	4	4	0
Sign Control	Stop	Stop	Free	Free	Free	Free
RT Channelized	-	None	-	None	-	None
Storage Length	-	-	-	-	150	-
Veh in Median Storage, #	2	-	0	-	-	0
Grade, %	0	-	0	-	-	0
Peak Hour Factor	87	87	87	87	87	87
Heavy Vehicles, %	0	0	6	6	5	5
Mvmt Flow	2	1	700	0	0	589

Major/Minor	Minor1	Major1	Major2		
Conflicting Flow All	1297	708	0	0	704
Stage 1	704	-	-	-	-
Stage 2	593	-	-	-	-
Critical Hdwy	6.4	6.2	-	-	4.15
Critical Hdwy Stg 1	5.4	-	-	-	-
Critical Hdwy Stg 2	5.4	-	-	-	-
Follow-up Hdwy	3.5	3.3	-	-	2.245
Pot Cap-1 Maneuver	180	438	-	-	880
Stage 1	494	-	-	-	-
Stage 2	556	-	-	-	-
Platoon blocked, %			-	-	-
Mov Cap-1 Maneuver	179	435	-	-	877
Mov Cap-2 Maneuver	385	-	-	-	-
Stage 1	492	-	-	-	-
Stage 2	554	-	-	-	-

Approach	WB	NB	SB
HCM Control Delay, s	14.1	0	0
HCM LOS	B		

Minor Lane/Major Mvmt	NBT	NBRWBLn1	SBL	SBT
Capacity (veh/h)	-	-	400	877
HCM Lane V/C Ratio	-	-	0.009	-
HCM Control Delay (s)	-	-	14.1	0
HCM Lane LOS	-	-	B	A
HCM 95th %tile Q(veh)	-	-	0	0

HCM 6th Signalized Intersection Summary

8: SW Boones Ferry Road & SW Day Road

06/24/2021



Movement	EBL	EBT	EBR	WBL	WBT	WBR	NBL	NBT	NBR	SBL	SBT	SBR
Lane Configurations		↔	↔		↔		↔	↔		↔	↔	
Traffic Volume (veh/h)	162	0	528	0	0	0	584	447	0	0	465	47
Future Volume (veh/h)	162	0	528	0	0	0	584	447	0	0	465	47
Initial Q (Qb), veh	0	0	0	0	0	0	0	0	0	0	0	0
Ped-Bike Adj(A_pbT)	1.00		1.00	1.00		1.00	1.00		1.00	1.00		1.00
Parking Bus, Adj	1.00	1.00	1.00	1.00	1.00	1.00	1.00	1.00	1.00	1.00	1.00	1.00
Work Zone On Approach		No			No			No			No	
Adj Sat Flow, veh/h/ln	1693	1693	1693	1900	1900	1900	1693	1693	1693	1796	1796	1796
Adj Flow Rate, veh/h	180	0	537	0	0	0	649	497	0	0	517	46
Peak Hour Factor	0.90	0.90	0.90	0.90	0.90	0.90	0.90	0.90	0.90	0.90	0.90	0.90
Percent Heavy Veh, %	14	14	14	0	0	0	14	14	14	7	7	7
Cap, veh/h	288	0	641	0	320	0	752	639	0	544	1336	119
Arrive On Green	0.16	0.00	0.17	0.00	0.00	0.00	0.09	0.12	0.00	0.00	0.42	0.41
Sat Flow, veh/h	1283	0	1434	0	1900	0	2740	1693	0	1711	3171	281
Grp Volume(v), veh/h	180	0	537	0	0	0	649	497	0	0	278	285
Grp Sat Flow(s),veh/h/ln	1283	0	1434	0	1900	0	1370	1693	0	1711	1706	1746
Q Serve(g_s), s	13.0	0.0	16.2	0.0	0.0	0.0	22.2	27.0	0.0	0.0	10.7	10.8
Cycle Q Clear(g_c), s	13.0	0.0	16.2	0.0	0.0	0.0	22.2	27.0	0.0	0.0	10.7	10.8
Prop In Lane	1.00		1.00	0.00		0.00	1.00		0.00	1.00		0.16
Lane Grp Cap(c), veh/h	285	0	641	0	320	0	752	639	0	544	719	735
V/C Ratio(X)	0.63	0.00	0.84	0.00	0.00	0.00	0.86	0.78	0.00	0.00	0.39	0.39
Avail Cap(c_a), veh/h	285	0	641	0	320	0	1041	1033	0	544	719	735
HCM Platoon Ratio	1.00	1.00	1.00	1.00	1.00	1.00	0.33	0.33	0.33	1.00	1.00	1.00
Upstream Filter(I)	1.00	0.00	1.00	0.00	0.00	0.00	0.92	0.92	0.00	0.00	1.00	1.00
Uniform Delay (d), s/veh	38.6	0.0	23.2	0.0	0.0	0.0	41.4	37.7	0.0	0.0	19.0	19.1
Incr Delay (d2), s/veh	4.0	0.0	9.3	0.0	0.0	0.0	4.5	8.4	0.0	0.0	1.6	1.5
Initial Q Delay(d3),s/veh	0.0	0.0	0.0	0.0	0.0	0.0	0.0	0.0	0.0	0.0	0.0	0.0
%ile BackOfQ(50%),veh/ln	4.3	0.0	11.3	0.0	0.0	0.0	8.6	13.6	0.0	0.0	4.2	4.3
Unsig. Movement Delay, s/veh												
LnGrp Delay(d),s/veh	42.6	0.0	32.5	0.0	0.0	0.0	45.9	46.1	0.0	0.0	20.6	20.6
LnGrp LOS	D	A	C	A	A	A	D	D	A	A	C	C
Approach Vol, veh/h		717			0			1146			563	
Approach Delay, s/veh		35.1			0.0			46.0			20.6	
Approach LOS		D						D			C	
Timer - Assigned Phs	1	2		4	5	6		8				
Phs Duration (G+Y+Rc), s	31.0	44.0		20.0	35.1	39.9		20.0				
Change Period (Y+Rc), s	* 5.4	* 5.4		4.5	* 5.4	* 5.4		4.5				
Max Green Setting (Gmax), s	* 36	* 29		15.5	* 8.5	* 57		15.5				
Max Q Clear Time (g_c+I1), s	24.2	12.8		0.0	0.0	29.0		18.2				
Green Ext Time (p_c), s	1.4	4.3		0.0	0.0	5.4		0.0				

Intersection Summary

HCM 6th Ctrl Delay	36.9
HCM 6th LOS	D

Notes

User approved pedestrian interval to be less than phase max green.

* HCM 6th computational engine requires equal clearance times for the phases crossing the barrier.

HCM 6th Signalized Intersection Summary
 9: SW Elligsen Road/SW Boones Ferry Road & SW 95th Avenue

06/24/2021



Movement	EBL	EBT	EBR	WBL	WBT	WBR	NBL	NBT	NBR	SBL	SBT	SBR
Lane Configurations		↕	↗	↖	↗	↖	↗	↖		↖	↗	↖
Traffic Volume (veh/h)	189	7	509	15	1	6	769	762	64	5	665	248
Future Volume (veh/h)	189	7	509	15	1	6	769	762	64	5	665	248
Initial Q (Qb), veh	0	0	0	0	0	0	0	0	0	0	0	0
Ped-Bike Adj(A_pbT)	1.00		0.99	1.00		1.00	1.00		1.00	1.00		1.00
Parking Bus, Adj	1.00	1.00	1.00	1.00	1.00	1.00	1.00	1.00	1.00	1.00	1.00	1.00
Work Zone On Approach		No		No		No		No		No		No
Adj Sat Flow, veh/h/ln	1648	1648	1648	1737	1737	1737	1796	1796	1796	1737	1737	1737
Adj Flow Rate, veh/h	205	8	515	16	1	7	836	828	70	5	723	0
Peak Hour Factor	0.92	0.92	0.92	0.92	0.92	0.92	0.92	0.92	0.92	0.92	0.92	0.92
Percent Heavy Veh, %	17	17	17	11	11	11	7	7	7	11	11	11
Cap, veh/h	297	9	1161	90	35	248	942	1114	94	501	1217	
Arrive On Green	0.19	0.19	0.19	0.19	0.19	0.19	0.47	0.58	0.58	0.10	0.12	0.00
Sat Flow, veh/h	1173	46	2445	816	187	1309	3319	3185	269	1654	3300	1472
Grp Volume(v), veh/h	213	0	515	16	0	8	836	444	454	5	723	0
Grp Sat Flow(s),veh/h/ln	1219	0	1223	816	0	1496	1659	1706	1747	1654	1650	1472
Q Serve(g_s), s	15.9	0.0	13.3	1.7	0.0	0.4	21.7	18.1	18.1	0.3	19.7	0.0
Cycle Q Clear(g_c), s	16.3	0.0	13.3	18.0	0.0	0.4	21.7	18.1	18.1	0.3	19.7	0.0
Prop In Lane	0.96		1.00	1.00		0.88	1.00		0.15	1.00		1.00
Lane Grp Cap(c), veh/h	305	0	1161	90	0	284	942	597	611	501	1217	
V/C Ratio(X)	0.70	0.00	0.44	0.18	0.00	0.03	0.89	0.74	0.74	0.01	0.59	
Avail Cap(c_a), veh/h	305	0	1161	90	0	284	1572	988	1012	501	1217	
HCM Platoon Ratio	1.00	1.00	1.00	1.00	1.00	1.00	1.67	1.67	1.67	0.33	0.33	0.33
Upstream Filter(I)	1.00	0.00	1.00	1.00	0.00	1.00	0.39	0.39	0.39	0.78	0.78	0.00
Uniform Delay (d), s/veh	38.0	0.0	16.7	46.8	0.0	31.4	23.6	16.6	16.6	29.9	35.0	0.0
Incr Delay (d2), s/veh	6.4	0.0	0.2	0.7	0.0	0.0	1.5	3.3	3.2	0.0	1.7	0.0
Initial Q Delay(d3),s/veh	0.0	0.0	0.0	0.0	0.0	0.0	0.0	0.0	0.0	0.0	0.0	0.0
%ile BackOfQ(50%),veh/ln	5.3	0.0	3.6	0.4	0.0	0.2	6.5	5.3	5.4	0.1	8.9	0.0
Unsig. Movement Delay, s/veh												
LnGrp Delay(d),s/veh	44.4	0.0	16.9	47.5	0.0	31.4	25.1	19.9	19.8	29.9	36.7	0.0
LnGrp LOS	D	A	B	D	A	C	C	B	B	C	D	
Approach Vol, veh/h		728			24			1734			728	A
Approach Delay, s/veh		24.9			42.1			22.4			36.6	
Approach LOS		C			D			C			D	
Timer - Assigned Phs	1	2		4	5	6		8				
Phs Duration (G+Y+Rc), s	32.0	40.0		23.0	33.8	38.2		23.0				
Change Period (Y+Rc), s	5.0	5.0		5.0	5.0	5.0		5.0				
Max Green Setting (Gmax), s	45.0	17.0		18.0	7.0	55.0		18.0				
Max Q Clear Time (g_c+Q), s	23.7	21.7		20.0	2.3	20.1		18.3				
Green Ext Time (p_c), s	3.3	0.0		0.0	0.0	13.1		0.0				

Intersection Summary

HCM 6th Ctrl Delay	26.3
HCM 6th LOS	C

Notes

- User approved pedestrian interval to be less than phase max green.
- Unsignalized Delay for [SBR] is excluded from calculations of the approach delay and intersection delay.

HCM Signalized Intersection Capacity Analysis

10: I-5 SB Ramps & SW Elligsen Road

06/24/2021



Movement	EBL	EBT	EBR	WBL	WBT	WBR	NBL	NBT	NBR	SBL	SBT	SBR	
Lane Configurations		↑↑	↗		↑↑	↗				↘	↖	↗	
Traffic Volume (vph)	0	865	324	0	672	110	0	0	0	491	0	921	
Future Volume (vph)	0	865	324	0	672	110	0	0	0	491	0	921	
Ideal Flow (vphpl)	1900	1900	1900	1900	1900	1900	1900	1900	1900	1900	1900	1900	
Lane Width	12	12	12	12	12	12	12	12	12	12	12	16	
Total Lost time (s)		4.0	4.0		4.0	4.0				4.0	4.0	4.0	
Lane Util. Factor		0.95	1.00		0.95	1.00				0.95	0.95	1.00	
Frbp, ped/bikes		1.00	0.99		1.00	1.00				1.00	1.00	1.00	
Flpb, ped/bikes		1.00	1.00		1.00	1.00				1.00	1.00	1.00	
Frt		1.00	0.85		1.00	0.85				1.00	1.00	0.85	
Flt Protected		1.00	1.00		1.00	1.00				0.95	0.95	1.00	
Satd. Flow (prot)		3034	1340		3406	1524				1573	1573	1679	
Flt Permitted		1.00	1.00		1.00	1.00				0.95	0.95	1.00	
Satd. Flow (perm)		3034	1340		3406	1524				1573	1573	1679	
Peak-hour factor, PHF	0.94	0.94	0.94	0.94	0.94	0.94	0.94	0.94	0.94	0.94	0.94	0.94	
Adj. Flow (vph)	0	920	345	0	715	117	0	0	0	522	0	980	
RTOR Reduction (vph)	0	0	0	0	0	0	0	0	0	0	0	9	
Lane Group Flow (vph)	0	920	345	0	715	117	0	0	0	261	261	971	
Confl. Peds. (#/hr)			2										
Heavy Vehicles (%)	19%	19%	19%	6%	6%	6%	0%	0%	0%	9%	9%	9%	
Turn Type		NA	Free		NA	Free				Split	NA	custom	
Protected Phases		2			6					4	4	5	
Permitted Phases			Free		6	Free						4	
Actuated Green, G (s)		65.6	95.0		22.6	95.0				19.9	19.9	58.4	
Effective Green, g (s)		66.6	95.0		23.6	95.0				20.4	20.4	59.4	
Actuated g/C Ratio		0.70	1.00		0.25	1.00				0.21	0.21	0.63	
Clearance Time (s)		5.0			5.0					4.5	4.5	4.5	
Vehicle Extension (s)		4.1			4.1					2.3	2.3	2.3	
Lane Grp Cap (vph)		2126	1340		846	1524				337	337	1120	
v/s Ratio Prot		0.30			c0.21					0.17	0.17	c0.36	
v/s Ratio Perm			0.26			0.08						0.22	
v/c Ratio		0.43	0.26		0.85	0.08				0.77	0.77	0.87	
Uniform Delay, d1		6.1	0.0		34.0	0.0				35.1	35.1	14.6	
Progression Factor		2.07	1.00		0.59	1.00				1.00	1.00	1.00	
Incremental Delay, d2		0.6	0.4		9.3	0.1				10.0	10.0	7.1	
Delay (s)		13.2	0.4		29.3	0.1				45.1	45.1	21.7	
Level of Service		B	A		C	A				D	D	C	
Approach Delay (s)		9.7			25.2			0.0			29.8		
Approach LOS		A			C			A			C		
Intersection Summary													
HCM 2000 Control Delay			21.7		HCM 2000 Level of Service						C		
HCM 2000 Volume to Capacity ratio			0.90										
Actuated Cycle Length (s)			95.0		Sum of lost time (s)					12.0			
Intersection Capacity Utilization			82.3%		ICU Level of Service					E			
Analysis Period (min)			15										
c Critical Lane Group													

V/C Ratio calculated using HCM worksheet with correct lost time

HCM 6th Signalized Intersection Summary
 11: I-5 NB Ramps & SW Elligsen Road

06/24/2021

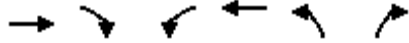

Movement	EBT	EBR	WBL	WBT	NBL	NBR
Lane Configurations	↑↑	↑		↑↑	↑↑	↑
Traffic Volume (veh/h)	692	665	0	304	477	241
Future Volume (veh/h)	692	665	0	304	477	241
Initial Q (Qb), veh	0	0	0	0	0	0
Ped-Bike Adj(A_pbT)		1.00	1.00		1.00	1.00
Parking Bus, Adj	1.00	1.00	1.00	1.00	1.00	1.00
Work Zone On Approach	No			No	No	
Adj Sat Flow, veh/h/ln	1707	1707	0	1796	1811	1811
Adj Flow Rate, veh/h	760	0	0	334	524	0
Peak Hour Factor	0.91	0.91	0.91	0.91	0.91	0.91
Percent Heavy Veh, %	13	13	0	7	6	6
Cap, veh/h	2368		0	2491	622	
Arrive On Green	0.24	0.00	0.00	0.73	0.19	0.00
Sat Flow, veh/h	3329	1447	0	3593	3346	1535
Grp Volume(v), veh/h	760	0	0	334	524	0
Grp Sat Flow(s),veh/h/ln	1622	1447	0	1706	1673	1535
Q Serve(g_s), s	18.3	0.0	0.0	2.8	14.4	0.0
Cycle Q Clear(g_c), s	18.3	0.0	0.0	2.8	14.4	0.0
Prop In Lane		1.00	0.00		1.00	1.00
Lane Grp Cap(c), veh/h	2368		0	2491	622	
V/C Ratio(X)	0.32		0.00	0.13	0.84	
Avail Cap(c_a), veh/h	2368		0	2491	810	
HCM Platoon Ratio	0.33	0.33	1.00	1.00	1.00	1.00
Upstream Filter(l)	0.85	0.00	0.00	1.00	1.00	0.00
Uniform Delay (d), s/veh	16.7	0.0	0.0	3.8	37.3	0.0
Incr Delay (d2), s/veh	0.3	0.0	0.0	0.1	5.6	0.0
Initial Q Delay(d3),s/veh	0.0	0.0	0.0	0.0	0.0	0.0
%ile BackOfQ(50%),veh/ln	7.9	0.0	0.0	0.8	6.3	0.0
Unsig. Movement Delay, s/veh						
LnGrp Delay(d),s/veh	17.0	0.0	0.0	4.0	42.9	0.0
LnGrp LOS	B		A	A	D	
Approach Vol, veh/h	760	A		334	524	A
Approach Delay, s/veh	17.0			4.0	42.9	
Approach LOS	B			A	D	
Timer - Assigned Phs		2			6	8
Phs Duration (G+Y+Rc), s		73.3			73.3	21.7
Change Period (Y+Rc), s		5.0			5.0	4.5
Max Green Setting (Gmax), s		63.0			63.0	22.5
Max Q Clear Time (g_c+I1), s		20.3			4.8	16.4
Green Ext Time (p_c), s		9.2			3.5	0.8

Intersection Summary

HCM 6th Ctrl Delay	22.7
HCM 6th LOS	C

Notes

Unsignalized Delay for [NBR, EBR] is excluded from calculations of the approach delay and intersection delay.

HCM 6th TWSC
12: SW Norwood Road & SW 89th Avenue

06/24/2021

Intersection						
Int Delay, s/veh	1.8					
Movement	EBL	EBT	WBT	WBR	SBL	SBR
Lane Configurations		↕	↕		↕	
Traffic Vol, veh/h	13	95	133	2	17	24
Future Vol, veh/h	13	95	133	2	17	24
Conflicting Peds, #/hr	1	0	0	2	2	1
Sign Control	Free	Free	Free	Free	Stop	Stop
RT Channelized	-	None	-	None	-	None
Storage Length	-	-	-	-	-	-
Veh in Median Storage, #	-	0	0	-	0	-
Grade, %	-	0	0	-	0	-
Peak Hour Factor	80	80	80	80	80	80
Heavy Vehicles, %	0	0	2	2	0	0
Mvmt Flow	16	119	166	3	21	30

Major/Minor	Major1	Major2	Minor2		
Conflicting Flow All	171	0	0	323	171
Stage 1	-	-	-	170	-
Stage 2	-	-	-	153	-
Critical Hdwy	4.1	-	-	6.4	6.2
Critical Hdwy Stg 1	-	-	-	5.4	-
Critical Hdwy Stg 2	-	-	-	5.4	-
Follow-up Hdwy	2.2	-	-	3.5	3.3
Pot Cap-1 Maneuver	1418	-	-	675	878
Stage 1	-	-	-	865	-
Stage 2	-	-	-	880	-
Platoon blocked, %	-	-	-	-	-
Mov Cap-1 Maneuver	1415	-	-	664	875
Mov Cap-2 Maneuver	-	-	-	664	-
Stage 1	-	-	-	853	-
Stage 2	-	-	-	878	-

Approach	EB	WB	SB
HCM Control Delay, s	0.9	0	10
HCM LOS			B

Minor Lane/Major Mvmt	EBL	EBT	WBT	WBR	SBLn1
Capacity (veh/h)	1415	-	-	-	773
HCM Lane V/C Ratio	0.011	-	-	-	0.066
HCM Control Delay (s)	7.6	0	-	-	10
HCM Lane LOS	A	A	-	-	B
HCM 95th %tile Q(veh)	0	-	-	-	0.2

HCM 6th TWSC
 13: SW Norwood Road & SW Vermillion Drive

06/24/2021

Intersection						
Int Delay, s/veh	3.2					
Movement	EBL	EBT	WBT	WBR	SBL	SBR
Lane Configurations		↕	↕		↕	
Traffic Vol, veh/h	19	93	94	6	36	41
Future Vol, veh/h	19	93	94	6	36	41
Conflicting Peds, #/hr	0	0	0	0	0	0
Sign Control	Free	Free	Free	Free	Stop	Stop
RT Channelized	-	None	-	None	-	None
Storage Length	-	-	-	-	-	-
Veh in Median Storage, #	-	0	0	-	0	-
Grade, %	-	0	0	-	0	-
Peak Hour Factor	81	81	81	81	81	81
Heavy Vehicles, %	0	0	3	3	0	0
Mvmt Flow	23	115	116	7	44	51

Major/Minor	Major1	Major2	Minor2		
Conflicting Flow All	123	0	-	0	281
Stage 1	-	-	-	-	120
Stage 2	-	-	-	-	161
Critical Hdwy	4.1	-	-	-	6.4
Critical Hdwy Stg 1	-	-	-	-	5.4
Critical Hdwy Stg 2	-	-	-	-	5.4
Follow-up Hdwy	2.2	-	-	-	3.5
Pot Cap-1 Maneuver	1477	-	-	-	713
Stage 1	-	-	-	-	910
Stage 2	-	-	-	-	873
Platoon blocked, %		-	-	-	
Mov Cap-1 Maneuver	1477	-	-	-	701
Mov Cap-2 Maneuver	-	-	-	-	701
Stage 1	-	-	-	-	895
Stage 2	-	-	-	-	873

Approach	EB	WB	SB
HCM Control Delay, s	1.3	0	10
HCM LOS			B

Minor Lane/Major Mvmt	EBL	EBT	WBT	WBR	SBLn1
Capacity (veh/h)	1477	-	-	-	810
HCM Lane V/C Ratio	0.016	-	-	-	0.117
HCM Control Delay (s)	7.5	0	-	-	10
HCM Lane LOS	A	A	-	-	B
HCM 95th %tile Q(veh)	0	-	-	-	0.4

HCM 6th TWSC
 14: SW 82nd Avenue & SW Norwood Road/Driveway

06/24/2021

Intersection												
Int Delay, s/veh	7.2											
Movement	EBL	EBT	EBR	WBL	WBT	WBR	NBL	NBT	NBR	SBL	SBT	SBR
Lane Configurations		↕			↕			↕			↕	↗
Traffic Vol, veh/h	106	0	23	0	0	0	34	4	0	0	0	66
Future Vol, veh/h	106	0	23	0	0	0	34	4	0	0	0	66
Conflicting Peds, #/hr	0	0	0	0	0	0	0	0	0	0	0	0
Sign Control	Free	Free	Free	Free	Free	Free	Stop	Stop	Stop	Stop	Stop	Stop
RT Channelized	-	-	None	-	-	None	-	-	None	-	-	Free
Storage Length	-	-	-	-	-	-	-	-	-	-	-	15
Veh in Median Storage, #	-	0	-	-	0	-	-	0	-	-	0	-
Grade, %	-	0	-	-	0	-	-	0	-	-	0	-
Peak Hour Factor	89	89	89	89	89	89	89	89	89	89	89	89
Heavy Vehicles, %	2	2	2	0	0	0	6	6	6	10	10	10
Mvmt Flow	119	0	26	0	0	0	38	4	0	0	0	74

Major/Minor	Major1			Major2			Minor1			Minor2		
Conflicting Flow All	1	0	0	26	0	0	252	252	13	254	265	-
Stage 1	-	-	-	-	-	-	251	251	-	1	1	-
Stage 2	-	-	-	-	-	-	1	1	-	253	264	-
Critical Hdwy	4.12	-	-	4.1	-	-	7.16	6.56	6.26	7.2	6.6	-
Critical Hdwy Stg 1	-	-	-	-	-	-	6.16	5.56	-	6.2	5.6	-
Critical Hdwy Stg 2	-	-	-	-	-	-	6.16	5.56	-	6.2	5.6	-
Follow-up Hdwy	2.218	-	-	2.2	-	-	3.554	4.054	3.354	3.59	4.09	-
Pot Cap-1 Maneuver	1622	-	-	1601	-	-	693	644	1056	683	627	0
Stage 1	-	-	-	-	-	-	744	692	-	1002	879	0
Stage 2	-	-	-	-	-	-	1012	887	-	734	676	0
Platoon blocked, %	-	-	-	-	-	-	-	-	-	-	-	-
Mov Cap-1 Maneuver	1622	-	-	1601	-	-	653	596	1056	640	580	-
Mov Cap-2 Maneuver	-	-	-	-	-	-	653	596	-	640	580	-
Stage 1	-	-	-	-	-	-	688	640	-	927	879	-
Stage 2	-	-	-	-	-	-	1012	887	-	674	625	-

Approach	EB	WB	NB	SB
HCM Control Delay, s	6.1	0	11	0
HCM LOS			B	A

Minor Lane/Major Mvmt	NBLn1	EBL	EBT	EBR	WBL	WBT	WBR	SBLn1	SBLn2
Capacity (veh/h)	646	1622	-	-	1601	-	-	-	-
HCM Lane V/C Ratio	0.066	0.073	-	-	-	-	-	-	-
HCM Control Delay (s)	11	7.4	0	-	0	-	-	0	0
HCM Lane LOS	B	A	A	-	A	-	-	A	A
HCM 95th %tile Q(veh)	0.2	0.2	-	-	0	-	-	-	-

HCM 6th TWSC
 15: SW 65th Avenue & SW Norwood Road

06/24/2021

Intersection						
Int Delay, s/veh	4.2					
Movement	EBL	EBR	NBL	NBT	SBT	SBR
Lane Configurations	T			T		
Traffic Vol, veh/h	119	45	35	319	222	55
Future Vol, veh/h	119	45	35	319	222	55
Conflicting Peds, #/hr	2	2	2	0	0	2
Sign Control	Stop	Stop	Free	Free	Free	Free
RT Channelized	-	None	-	None	-	None
Storage Length	-	-	-	-	-	-
Veh in Median Storage, #	0	-	-	0	0	-
Grade, %	0	-	-	0	0	-
Peak Hour Factor	90	90	90	90	90	90
Heavy Vehicles, %	2	2	2	2	6	6
Mvmt Flow	132	50	39	354	247	61

Major/Minor	Minor2	Major1		Major2	
Conflicting Flow All	714	282	310	0	0
Stage 1	280	-	-	-	-
Stage 2	434	-	-	-	-
Critical Hdwy	6.42	6.22	4.12	-	-
Critical Hdwy Stg 1	5.42	-	-	-	-
Critical Hdwy Stg 2	5.42	-	-	-	-
Follow-up Hdwy	3.518	3.318	2.218	-	-
Pot Cap-1 Maneuver	398	757	1250	-	-
Stage 1	767	-	-	-	-
Stage 2	653	-	-	-	-
Platoon blocked, %				-	-
Mov Cap-1 Maneuver	381	754	1248	-	-
Mov Cap-2 Maneuver	381	-	-	-	-
Stage 1	736	-	-	-	-
Stage 2	652	-	-	-	-

Approach	EB	NB	SB
HCM Control Delay, s	18.8	0.8	0
HCM LOS	C		

Minor Lane/Major Mvmt	NBL	NBT	EBLn1	SBT	SBR
Capacity (veh/h)	1248	-	441	-	-
HCM Lane V/C Ratio	0.031	-	0.413	-	-
HCM Control Delay (s)	8	0	18.8	-	-
HCM Lane LOS	A	A	C	-	-
HCM 95th %tile Q(veh)	0.1	-	2	-	-

HCM 6th Signalized Intersection Summary
 1: SW Boones Ferry Rd & SW Sagert St

06/24/2021



Movement	EBL	EBT	EBR	WBL	WBT	WBR	NBL	NBT	NBR	SBL	SBT	SBR
Lane Configurations												
Traffic Volume (veh/h)	51	157	9	203	89	39	20	348	275	82	602	55
Future Volume (veh/h)	51	157	9	203	89	39	20	348	275	82	602	55
Initial Q (Qb), veh	0	0	0	0	0	0	0	0	0	0	0	0
Ped-Bike Adj(A_pbT)	0.99		0.99	1.00		1.00	1.00		0.98	1.00		0.98
Parking Bus, Adj	1.00	1.00	1.00	1.00	1.00	1.00	1.00	1.00	1.00	1.00	1.00	1.00
Work Zone On Approach		No			No			No			No	
Adj Sat Flow, veh/h/ln	1885	1885	1885	1900	1900	1900	1885	1885	1885	1885	1885	1885
Adj Flow Rate, veh/h	56	173	10	223	98	43	22	382	280	90	662	60
Peak Hour Factor	0.91	0.91	0.91	0.91	0.91	0.91	0.91	0.91	0.91	0.91	0.91	0.91
Percent Heavy Veh, %	1	1	1	0	0	0	1	1	1	1	1	1
Cap, veh/h	348	234	14	374	266	117	315	474	347	310	950	787
Arrive On Green	0.05	0.13	0.13	0.13	0.21	0.21	0.03	0.47	0.46	0.06	0.50	0.50
Sat Flow, veh/h	1795	1764	102	1810	1250	548	1795	1000	733	1795	1885	1560
Grp Volume(v), veh/h	56	0	183	223	0	141	22	0	662	90	662	60
Grp Sat Flow(s),veh/h/ln	1795	0	1866	1810	0	1798	1795	0	1732	1795	1885	1560
Q Serve(g_s), s	2.1	0.0	7.5	7.9	0.0	5.3	0.5	0.0	25.9	2.0	21.3	1.6
Cycle Q Clear(g_c), s	2.1	0.0	7.5	7.9	0.0	5.3	0.5	0.0	25.9	2.0	21.3	1.6
Prop In Lane	1.00		0.05	1.00		0.30	1.00		0.42	1.00		1.00
Lane Grp Cap(c), veh/h	348	0	248	374	0	382	315	0	821	310	950	787
V/C Ratio(X)	0.16	0.00	0.74	0.60	0.00	0.37	0.07	0.00	0.81	0.29	0.70	0.08
Avail Cap(c_a), veh/h	506	0	376	389	0	382	509	0	1223	450	1331	1102
HCM Platoon Ratio	1.00	1.00	1.00	1.00	1.00	1.00	1.00	1.00	1.00	1.00	1.00	1.00
Upstream Filter(I)	1.00	0.00	1.00	1.00	0.00	1.00	1.00	0.00	1.00	1.00	1.00	1.00
Uniform Delay (d), s/veh	27.3	0.0	33.1	23.6	0.0	26.7	12.4	0.0	18.0	14.0	15.0	10.1
Incr Delay (d2), s/veh	0.1	0.0	1.6	1.5	0.0	0.2	0.0	0.0	3.7	0.2	1.6	0.1
Initial Q Delay(d3),s/veh	0.0	0.0	0.0	0.0	0.0	0.0	0.0	0.0	0.0	0.0	0.0	0.0
%ile BackOfQ(50%),veh/ln	0.9	0.0	3.4	3.4	0.0	2.2	0.2	0.0	10.3	0.7	8.6	0.5
Unsig. Movement Delay, s/veh												
LnGrp Delay(d),s/veh	27.3	0.0	34.7	25.1	0.0	27.0	12.5	0.0	21.7	14.2	16.6	10.2
LnGrp LOS	C	A	C	C	A	C	B	A	C	B	B	B
Approach Vol, veh/h		239			364			684			812	
Approach Delay, s/veh		33.0			25.8			21.4			15.9	
Approach LOS		C			C			C			B	
Timer - Assigned Phs	1	2	3	4	5	6	7	8				
Phs Duration (G+Y+Rc), s	8.8	41.6	14.4	14.5	6.4	44.0	8.0	20.9				
Change Period (Y+Rc), s	4.5	5.0	4.5	4.5	4.5	5.0	4.5	4.5				
Max Green Setting (Gmax), s	10.5	55.0	10.5	15.5	10.5	55.0	10.5	15.5				
Max Q Clear Time (g_c+I1), s	4.0	27.9	9.9	9.5	2.5	23.3	4.1	7.3				
Green Ext Time (p_c), s	0.0	8.7	0.0	0.3	0.0	9.3	0.0	0.3				

Intersection Summary

HCM 6th Ctrl Delay	21.3
HCM 6th LOS	C

Notes

User approved pedestrian interval to be less than phase max green.

HCM 6th Signalized Intersection Summary

2: SW Boones Ferry Rd & SW Avery St

06/24/2021



Movement	EBL	EBT	EBR	WBL	WBT	WBR	NBL	NBT	NBR	SBL	SBT	SBR
Lane Configurations												
Traffic Volume (veh/h)	234	119	248	48	41	8	106	401	40	13	705	96
Future Volume (veh/h)	234	119	248	48	41	8	106	401	40	13	705	96
Initial Q (Qb), veh	0	0	0	0	0	0	0	0	0	0	0	0
Ped-Bike Adj(A_pbT)	1.00		0.97	1.00		0.99	1.00		0.98	1.00		0.97
Parking Bus, Adj	1.00	1.00	1.00	1.00	1.00	1.00	1.00	1.00	1.00	1.00	1.00	1.00
Work Zone On Approach		No		No		No		No		No		No
Adj Sat Flow, veh/h/ln	1841	1841	1841	1870	1870	1870	1811	1811	1811	1870	1870	1870
Adj Flow Rate, veh/h	244	124	258	50	43	8	110	418	42	14	734	90
Peak Hour Factor	0.96	0.96	0.96	0.96	0.96	0.96	0.96	0.96	0.96	0.96	0.96	0.96
Percent Heavy Veh, %	4	4	4	2	2	2	6	6	6	2	2	2
Cap, veh/h	464	131	273	143	236	44	211	873	88	438	829	102
Arrive On Green	0.13	0.25	0.24	0.04	0.15	0.14	0.05	0.54	0.53	0.02	0.51	0.51
Sat Flow, veh/h	1753	521	1084	1781	1531	285	1725	1615	162	1781	1629	200
Grp Volume(v), veh/h	244	0	382	50	0	51	110	0	460	14	0	824
Grp Sat Flow(s),veh/h/ln	1753	0	1605	1781	0	1816	1725	0	1777	1781	0	1828
Q Serve(g_s), s	11.7	0.0	24.2	2.4	0.0	2.5	3.1	0.0	16.6	0.4	0.0	41.6
Cycle Q Clear(g_c), s	11.7	0.0	24.2	2.4	0.0	2.5	3.1	0.0	16.6	0.4	0.0	41.6
Prop In Lane	1.00		0.68	1.00		0.16	1.00		0.09	1.00		0.11
Lane Grp Cap(c), veh/h	464	0	404	143	0	280	211	0	961	438	0	931
V/C Ratio(X)	0.53	0.00	0.95	0.35	0.00	0.18	0.52	0.00	0.48	0.03	0.00	0.89
Avail Cap(c_a), veh/h	585	0	404	181	0	280	229	0	1049	513	0	1079
HCM Platoon Ratio	1.00	1.00	1.00	1.00	1.00	1.00	1.00	1.00	1.00	1.00	1.00	1.00
Upstream Filter(I)	1.00	0.00	1.00	1.00	0.00	1.00	1.00	0.00	1.00	1.00	0.00	1.00
Uniform Delay (d), s/veh	29.7	0.0	38.3	36.6	0.0	38.1	21.7	0.0	14.8	13.3	0.0	22.7
Incr Delay (d2), s/veh	0.3	0.0	30.9	0.5	0.0	0.1	0.7	0.0	0.5	0.0	0.0	8.6
Initial Q Delay(d3),s/veh	0.0	0.0	0.0	0.0	0.0	0.0	0.0	0.0	0.0	0.0	0.0	0.0
%ile BackOfQ(50%),veh/ln	4.9	0.0	12.8	1.1	0.0	1.1	1.2	0.0	6.6	0.2	0.0	19.0
Unsig. Movement Delay, s/veh												
LnGrp Delay(d),s/veh	30.0	0.0	69.2	37.2	0.0	38.2	22.4	0.0	15.3	13.4	0.0	31.3
LnGrp LOS	C	A	E	D	A	D	C	A	B	B	A	C
Approach Vol, veh/h		626			101			570			838	
Approach Delay, s/veh		54.0			37.7			16.7			31.0	
Approach LOS		D			D			B			C	
Timer - Assigned Phs	1	2	3	4	5	6	7	8				
Phs Duration (G+Y+Rc), s	5.7	59.9	7.8	30.0	8.9	56.6	17.9	20.0				
Change Period (Y+Rc), s	4.0	5.5	4.0	5.0	4.0	5.5	4.0	5.0				
Max Green Setting (Gmax), s	6.0	59.5	6.0	25.0	6.0	59.5	21.0	10.0				
Max Q Clear Time (g_c+1), s	12.4	18.6	4.4	26.2	5.1	43.6	13.7	4.5				
Green Ext Time (p_c), s	0.0	4.9	0.0	0.0	0.0	7.5	0.1	0.0				

Intersection Summary

HCM 6th Ctrl Delay	34.2
HCM 6th LOS	C

Notes

User approved pedestrian interval to be less than phase max green.

HCM 6th Signalized Intersection Summary

3: SW Boones Ferry Road & SW Ibach Street/SW Ibach Court

06/24/2021



Movement	EBL	EBT	EBR	WBL	WBT	WBR	NBL	NBT	NBR	SBL	SBT	SBR
Lane Configurations	↖	↗			↕		↖	↗		↖	↗	↖
Traffic Volume (veh/h)	150	0	150	3	1	5	183	392	2	11	726	264
Future Volume (veh/h)	150	0	150	3	1	5	183	392	2	11	726	264
Initial Q (Qb), veh	0	0	0	0	0	0	0	0	0	0	0	0
Ped-Bike Adj(A_pbT)	0.96		0.98	0.99		0.95	1.00		0.99	1.00		0.99
Parking Bus, Adj	1.00	1.00	1.00	1.00	1.00	1.00	1.00	1.00	1.00	1.00	1.00	1.00
Work Zone On Approach		No			No			No			No	
Adj Sat Flow, veh/h/ln	1885	1885	1885	1900	1900	1900	1841	1841	1841	1870	1870	1870
Adj Flow Rate, veh/h	156	0	141	3	1	4	191	408	1	11	756	206
Peak Hour Factor	0.96	0.96	0.96	0.96	0.96	0.96	0.96	0.96	0.96	0.96	0.96	0.96
Percent Heavy Veh, %	1	1	1	0	0	0	4	4	4	2	2	2
Cap, veh/h	325	0	267	116	53	101	231	1159	3	20	955	803
Arrive On Green	0.17	0.00	0.17	0.17	0.17	0.17	0.13	0.63	0.63	0.01	0.51	0.51
Sat Flow, veh/h	1369	0	1560	281	309	590	1753	1835	4	1781	1870	1573
Grp Volume(v), veh/h	156	0	141	8	0	0	191	0	409	11	756	206
Grp Sat Flow(s),veh/h/ln	1369	0	1560	1180	0	0	1753	0	1840	1781	1870	1573
Q Serve(g_s), s	2.3	0.0	6.0	0.0	0.0	0.0	7.7	0.0	7.6	0.4	24.1	5.3
Cycle Q Clear(g_c), s	8.3	0.0	6.0	6.0	0.0	0.0	7.7	0.0	7.6	0.4	24.1	5.3
Prop In Lane	1.00		1.00	0.37		0.50	1.00		0.00	1.00		1.00
Lane Grp Cap(c), veh/h	325	0	267	271	0	0	231	0	1162	20	955	803
V/C Ratio(X)	0.48	0.00	0.53	0.03	0.00	0.00	0.83	0.00	0.35	0.56	0.79	0.26
Avail Cap(c_a), veh/h	572	0	549	531	0	0	266	0	1396	270	1419	1193
HCM Platoon Ratio	1.00	1.00	1.00	1.00	1.00	1.00	1.00	1.00	1.00	1.00	1.00	1.00
Upstream Filter(I)	1.00	0.00	1.00	1.00	0.00	0.00	1.00	0.00	1.00	1.00	1.00	1.00
Uniform Delay (d), s/veh	28.4	0.0	27.4	25.1	0.0	0.0	30.7	0.0	6.3	35.7	14.6	10.0
Incr Delay (d2), s/veh	0.7	0.0	1.0	0.0	0.0	0.0	15.9	0.0	0.3	14.6	2.7	0.3
Initial Q Delay(d3),s/veh	0.0	0.0	0.0	0.0	0.0	0.0	0.0	0.0	0.0	0.0	0.0	0.0
%ile BackOfQ(50%),veh/ln	2.5	0.0	2.2	0.1	0.0	0.0	4.1	0.0	2.4	0.3	9.3	1.7
Unsig. Movement Delay, s/veh												
LnGrp Delay(d),s/veh	29.1	0.0	28.3	25.1	0.0	0.0	46.6	0.0	6.6	50.3	17.2	10.2
LnGrp LOS	C	A	C	C	A	A	D	A	A	D	B	B
Approach Vol, veh/h		297			8			600			973	
Approach Delay, s/veh		28.7			25.1			19.3			16.1	
Approach LOS		C			C			B			B	
Timer - Assigned Phs	1	2		4	5	6		8				
Phs Duration (G+Y+Rc), s	4.8	50.8		16.9	13.5	42.0		16.9				
Change Period (Y+Rc), s	4.0	5.0		4.5	4.0	5.0		4.5				
Max Green Setting (Gmax), s	1.0	55.0		25.5	11.0	55.0		25.5				
Max Q Clear Time (g_c+1), s	12.4	9.6		10.3	9.7	26.1		8.0				
Green Ext Time (p_c), s	0.0	4.5		0.8	0.0	11.0		0.0				

Intersection Summary

HCM 6th Ctrl Delay	19.2
HCM 6th LOS	B

HCM 6th TWSC
4: SW Boones Ferry Road & SW Iowa Drive

06/24/2021

Intersection												
Int Delay, s/veh	3.6											
Movement	EBL	EBT	EBR	WBL	WBT	WBR	NBL	NBT	NBR	SBL	SBT	SBR
Lane Configurations		↕			↕		↕	↕		↕	↕	
Traffic Vol, veh/h	34	0	32	12	1	35	31	481	27	33	719	46
Future Vol, veh/h	34	0	32	12	1	35	31	481	27	33	719	46
Conflicting Peds, #/hr	0	0	4	4	0	0	4	0	4	0	0	0
Sign Control	Stop	Stop	Stop	Stop	Stop	Stop	Free	Free	Free	Free	Free	Free
RT Channelized	-	-	None	-	-	None	-	-	None	-	-	None
Storage Length	-	-	-	-	-	-	95	-	-	105	-	-
Veh in Median Storage, #	-	0	-	-	0	-	-	0	-	-	0	-
Grade, %	-	0	-	-	0	-	-	0	-	-	0	-
Peak Hour Factor	94	94	94	94	94	94	94	94	94	94	94	94
Heavy Vehicles, %	5	5	5	2	2	2	3	3	3	1	1	1
Mvmt Flow	36	0	34	13	1	37	33	512	29	35	765	49

Major/Minor	Minor2		Minor1		Major1			Major2				
Conflicting Flow All	1476	1475	798	1478	1485	531	818	0	0	545	0	0
Stage 1	864	864	-	597	597	-	-	-	-	-	-	-
Stage 2	612	611	-	881	888	-	-	-	-	-	-	-
Critical Hdwy	7.15	6.55	6.25	7.12	6.52	6.22	4.13	-	-	4.11	-	-
Critical Hdwy Stg 1	6.15	5.55	-	6.12	5.52	-	-	-	-	-	-	-
Critical Hdwy Stg 2	6.15	5.55	-	6.12	5.52	-	-	-	-	-	-	-
Follow-up Hdwy	3.545	4.045	3.345	3.518	4.018	3.318	2.227	-	-	2.209	-	-
Pot Cap-1 Maneuver	103	124	381	104	125	548	806	-	-	1029	-	-
Stage 1	345	367	-	490	491	-	-	-	-	-	-	-
Stage 2	475	480	-	341	362	-	-	-	-	-	-	-
Platoon blocked, %								-	-	-	-	-
Mov Cap-1 Maneuver	90	114	378	89	115	546	803	-	-	1025	-	-
Mov Cap-2 Maneuver	90	114	-	89	115	-	-	-	-	-	-	-
Stage 1	329	353	-	468	469	-	-	-	-	-	-	-
Stage 2	423	458	-	299	348	-	-	-	-	-	-	-

Approach	EB		WB		NB		SB	
HCM Control Delay, s	52.3		25		0.6		0.4	
HCM LOS	F		D					

Minor Lane/Major Mvmt	NBL	NBT	NBR	EBLn1WBLn1	SBL	SBT	SBR
Capacity (veh/h)	803	-	-	143	231	1025	-
HCM Lane V/C Ratio	0.041	-	-	0.491	0.221	0.034	-
HCM Control Delay (s)	9.7	-	-	52.3	25	8.6	-
HCM Lane LOS	A	-	-	F	D	A	-
HCM 95th %tile Q(veh)	0.1	-	-	2.3	0.8	0.1	-

HCM 6th TWSC
5: SW Boones Ferry Road & SW Norwood Road

06/24/2021

Intersection						
Int Delay, s/veh	1.8					
Movement	WBL	WBR	NBT	NBR	SBL	SBT
Lane Configurations	Y		↑	↑	↑	↑
Traffic Vol, veh/h	37	72	467	90	84	679
Future Vol, veh/h	37	72	467	90	84	679
Conflicting Peds, #/hr	2	2	0	2	2	0
Sign Control	Stop	Stop	Free	Free	Free	Free
RT Channelized	-	None	-	None	-	None
Storage Length	-	-	-	65	290	-
Veh in Median Storage, #	0	-	0	-	-	0
Grade, %	0	-	0	-	-	0
Peak Hour Factor	95	95	95	95	95	95
Heavy Vehicles, %	2	2	3	3	2	2
Mvmt Flow	39	76	492	95	88	715

Major/Minor	Minor1	Major1	Major2		
Conflicting Flow All	1387	496	0	0	589
Stage 1	494	-	-	-	-
Stage 2	893	-	-	-	-
Critical Hdwy	6.42	6.22	-	-	4.12
Critical Hdwy Stg 1	5.42	-	-	-	-
Critical Hdwy Stg 2	5.42	-	-	-	-
Follow-up Hdwy	3.518	3.318	-	-	2.218
Pot Cap-1 Maneuver	158	574	-	-	986
Stage 1	613	-	-	-	-
Stage 2	400	-	-	-	-
Platoon blocked, %			-	-	-
Mov Cap-1 Maneuver	143	572	-	-	984
Mov Cap-2 Maneuver	268	-	-	-	-
Stage 1	612	-	-	-	-
Stage 2	364	-	-	-	-

Approach	WB	NB	SB
HCM Control Delay, s	17	0	1
HCM LOS	C		

Minor Lane/Major Mvmt	NBT	NBRWBLn1	SBL	SBT
Capacity (veh/h)	-	-	413	984
HCM Lane V/C Ratio	-	-	0.278	0.09
HCM Control Delay (s)	-	-	17	9
HCM Lane LOS	-	-	C	A
HCM 95th %tile Q(veh)	-	-	1.1	0.3

Intersection						
Int Delay, s/veh	0					
Movement	WBL	WBR	NBT	NBR	SBL	SBT
Lane Configurations						
Traffic Vol, veh/h	0	0	552	2	1	728
Future Vol, veh/h	0	0	552	2	1	728
Conflicting Peds, #/hr	2	2	0	2	2	0
Sign Control	Stop	Stop	Free	Free	Free	Free
RT Channelized	-	None	-	None	-	None
Storage Length	-	-	-	-	150	-
Veh in Median Storage, #	2	-	0	-	-	0
Grade, %	0	-	0	-	-	0
Peak Hour Factor	95	95	95	95	95	95
Heavy Vehicles, %	0	0	3	3	2	2
Mvmt Flow	0	0	581	2	1	766

Major/Minor	Minor1	Major1	Major2		
Conflicting Flow All	1354	586	0	0	585
Stage 1	584	-	-	-	-
Stage 2	770	-	-	-	-
Critical Hdwy	6.4	6.2	-	-	4.12
Critical Hdwy Stg 1	5.4	-	-	-	-
Critical Hdwy Stg 2	5.4	-	-	-	-
Follow-up Hdwy	3.5	3.3	-	-	2.218
Pot Cap-1 Maneuver	167	514	-	-	990
Stage 1	561	-	-	-	-
Stage 2	460	-	-	-	-
Platoon blocked, %			-	-	-
Mov Cap-1 Maneuver	166	512	-	-	988
Mov Cap-2 Maneuver	369	-	-	-	-
Stage 1	560	-	-	-	-
Stage 2	459	-	-	-	-

Approach	WB	NB	SB
HCM Control Delay, s	0	0	0
HCM LOS	A		

Minor Lane/Major Mvmt	NBT	NBRWBLn1	SBL	SBT
Capacity (veh/h)	-	-	988	-
HCM Lane V/C Ratio	-	-	0.001	-
HCM Control Delay (s)	-	-	0	8.6
HCM Lane LOS	-	-	A	A
HCM 95th %tile Q(veh)	-	-	-	0

HCM 6th Signalized Intersection Summary

8: SW Boones Ferry Road & SW Day Road

06/24/2021



Movement	EBL	EBT	EBR	WBL	WBT	WBR	NBL	NBT	NBR	SBL	SBT	SBR
Lane Configurations		↖	↗		↔		↖	↗		↖	↗	
Traffic Volume (veh/h)	3	0	737	0	0	0	604	549	0	0	664	64
Future Volume (veh/h)	3	0	737	0	0	0	604	549	0	0	664	64
Initial Q (Qb), veh	0	0	0	0	0	0	0	0	0	0	0	0
Ped-Bike Adj(A_pbT)	1.00		1.00	1.00		1.00	1.00		1.00	1.00		1.00
Parking Bus, Adj	1.00	1.00	1.00	1.00	1.00	1.00	1.00	1.00	1.00	1.00	1.00	1.00
Work Zone On Approach		No			No			No			No	
Adj Sat Flow, veh/h/ln	1870	1870	1870	1900	1900	1900	1856	1856	1856	1885	1885	1885
Adj Flow Rate, veh/h	3	0	568	0	0	0	616	560	0	0	678	62
Peak Hour Factor	0.98	0.98	0.98	0.98	0.98	0.98	0.98	0.98	0.98	0.98	0.98	0.98
Percent Heavy Veh, %	2	2	2	0	0	0	3	3	3	1	1	1
Cap, veh/h	271	0	632	0	271	0	699	650	0	672	1645	150
Arrive On Green	0.14	0.00	0.15	0.00	0.00	0.00	0.41	0.59	0.00	0.00	0.50	0.48
Sat Flow, veh/h	1417	0	1585	0	1900	0	2827	1856	0	1795	3318	303
Grp Volume(v), veh/h	3	0	568	0	0	0	616	560	0	0	366	374
Grp Sat Flow(s),veh/h/ln	1418	0	1585	0	1900	0	1414	1856	0	1795	1791	1831
Q Serve(g_s), s	0.2	0.0	15.9	0.0	0.0	0.0	21.1	26.5	0.0	0.0	13.6	13.7
Cycle Q Clear(g_c), s	0.2	0.0	15.9	0.0	0.0	0.0	21.1	26.5	0.0	0.0	13.6	13.7
Prop In Lane	1.00		1.00	0.00		0.00	1.00		0.00	1.00		0.17
Lane Grp Cap(c), veh/h	264	0	632	0	271	0	699	650	0	672	888	907
V/C Ratio(X)	0.01	0.00	0.90	0.00	0.00	0.00	0.88	0.86	0.00	0.00	0.41	0.41
Avail Cap(c_a), veh/h	264	0	632	0	271	0	1158	1219	0	672	888	907
HCM Platoon Ratio	1.00	1.00	1.00	1.00	1.00	1.00	1.67	1.67	1.67	1.00	1.00	1.00
Upstream Filter(I)	1.00	0.00	1.00	0.00	0.00	0.00	0.92	0.92	0.00	0.00	1.00	1.00
Uniform Delay (d), s/veh	38.9	0.0	29.6	0.0	0.0	0.0	29.4	19.7	0.0	0.0	16.8	16.9
Incr Delay (d2), s/veh	0.0	0.0	15.7	0.0	0.0	0.0	3.1	13.1	0.0	0.0	1.4	1.4
Initial Q Delay(d3),s/veh	0.0	0.0	0.0	0.0	0.0	0.0	0.0	0.0	0.0	0.0	0.0	0.0
%ile BackOfQ(50%),veh/ln	0.1	0.0	15.3	0.0	0.0	0.0	6.1	10.2	0.0	0.0	5.5	5.6
Unsig. Movement Delay, s/veh												
LnGrp Delay(d),s/veh	38.9	0.0	45.3	0.0	0.0	0.0	32.5	32.7	0.0	0.0	18.2	18.3
LnGrp LOS	D	A	D	A	A	A	C	C	A	A	B	B
Approach Vol, veh/h		571			0			1176			740	
Approach Delay, s/veh		45.2			0.0			32.6			18.2	
Approach LOS		D						C			B	
Timer - Assigned Phs	1	2		4	5	6		8				
Phs Duration (G+Y+Rc), s	30.0	56.0		19.0	45.2	40.8		19.0				
Change Period (Y+Rc), s	* 5.4	* 5.4		4.5	* 5.4	* 5.4		4.5				
Max Green Setting (Gmax), s	* 42	* 34		14.5	* 8.5	* 68		14.5				
Max Q Clear Time (g_c+I1), s	23.1	15.7		0.0	0.0	28.5		17.9				
Green Ext Time (p_c), s	1.4	6.2		0.0	0.0	6.9		0.0				

Intersection Summary

HCM 6th Ctrl Delay	31.2
HCM 6th LOS	C

Notes

User approved pedestrian interval to be less than phase max green.

* HCM 6th computational engine requires equal clearance times for the phases crossing the barrier.

HCM 6th Signalized Intersection Summary

9: SW Boones Ferry Road & SW 95th Avenue

06/24/2021



Movement	EBL	EBT	EBR	WBL	WBT	WBR	NBL	NBT	NBR	SBL	SBT	SBR
Lane Configurations		↕	↗	↖	↗	↖	↗	↖		↖	↗	↖
Traffic Volume (veh/h)	219	1	758	45	16	6	550	840	11	3	1076	223
Future Volume (veh/h)	219	1	758	45	16	6	550	840	11	3	1076	223
Initial Q (Qb), veh	0	0	0	0	0	0	0	0	0	0	0	0
Ped-Bike Adj(A_pbT)	0.99		0.97	1.00		0.99	1.00		1.00	1.00		1.00
Parking Bus, Adj	1.00	1.00	1.00	1.00	1.00	1.00	1.00	1.00	1.00	1.00	1.00	1.00
Work Zone On Approach		No		No		No		No		No		No
Adj Sat Flow, veh/h/ln	1826	1826	1826	1870	1870	1870	1781	1781	1781	1856	1856	1856
Adj Flow Rate, veh/h	228	1	790	47	17	6	573	875	11	3	1121	0
Peak Hour Factor	0.96	0.96	0.96	0.96	0.96	0.96	0.96	0.96	0.96	0.96	0.96	0.96
Percent Heavy Veh, %	5	5	5	2	2	2	8	8	8	3	3	3
Cap, veh/h	283	1	1008	75	226	80	673	1144	14	672	1798	
Arrive On Green	0.16	0.17	0.17	0.17	0.17	0.17	0.41	0.67	0.65	0.76	1.00	0.00
Sat Flow, veh/h	1254	6	2634	685	1318	465	3291	3423	43	1767	3526	1572
Grp Volume(v), veh/h	229	0	790	47	0	23	573	433	453	3	1121	0
Grp Sat Flow(s),veh/h/ln	1260	0	1317	685	0	1784	1646	1692	1773	1767	1763	1572
Q Serve(g_s), s	15.9	0.0	18.0	1.0	0.0	1.1	16.6	18.2	18.2	0.0	0.0	0.0
Cycle Q Clear(g_c), s	17.0	0.0	18.0	18.0	0.0	1.1	16.6	18.2	18.2	0.0	0.0	0.0
Prop In Lane	1.00		1.00	1.00		0.26	1.00		0.02	1.00		1.00
Lane Grp Cap(c), veh/h	272	0	1008	75	0	306	673	566	593	672	1798	
V/C Ratio(X)	0.84	0.00	0.78	0.63	0.00	0.08	0.85	0.77	0.77	0.00	0.62	
Avail Cap(c_a), veh/h	272	0	1008	75	0	306	1066	1048	1098	672	1798	
HCM Platoon Ratio	1.00	1.00	1.00	1.00	1.00	1.00	2.00	2.00	2.00	2.00	2.00	2.00
Upstream Filter(I)	1.00	0.00	1.00	1.00	0.00	1.00	0.64	0.64	0.64	0.63	0.63	0.00
Uniform Delay (d), s/veh	45.0	0.0	29.2	52.4	0.0	36.5	29.6	14.6	14.6	7.8	0.0	0.0
Incr Delay (d2), s/veh	20.0	0.0	4.0	13.8	0.0	0.1	2.6	6.3	6.0	0.0	1.0	0.0
Initial Q Delay(d3),s/veh	0.0	0.0	0.0	0.0	0.0	0.0	0.0	0.0	0.0	0.0	0.0	0.0
%ile BackOfQ(50%),veh/ln	7.6	0.0	9.2	1.5	0.0	0.5	5.2	5.0	5.2	0.0	0.3	0.0
Unsig. Movement Delay, s/veh												
LnGrp Delay(d),s/veh	65.0	0.0	33.1	66.2	0.0	36.6	32.2	20.9	20.6	7.8	1.0	0.0
LnGrp LOS	E	A	C	E	A	D	C	C	C	A	A	
Approach Vol, veh/h		1019			70			1459			1124	A
Approach Delay, s/veh		40.3			56.5			25.2			1.1	
Approach LOS		D			E			C			A	
Timer - Assigned Phs	1	2		4	5	6		8				
Phs Duration (G+Y+Rc), s	25.5	57.5		22.0	43.9	39.1		22.0				
Change Period (Y+Rc), s	5.0	5.0		5.0	5.0	5.0		5.0				
Max Green Setting (Gmax), s	33.0	40.0		17.0	9.0	64.0		17.0				
Max Q Clear Time (g_c+1), s	11.6	2.0		20.0	2.0	20.2		20.0				
Green Ext Time (p_c), s	1.9	10.1		0.0	0.0	13.9		0.0				

Intersection Summary

HCM 6th Ctrl Delay	22.6
HCM 6th LOS	C

Notes

- User approved pedestrian interval to be less than phase max green.
- Unsignalized Delay for [SBR] is excluded from calculations of the approach delay and intersection delay.

HCM Signalized Intersection Capacity Analysis
 10: I-5 SB Ramps & SW Boones Ferry Road/SW Elligsen Road

06/30/2021



Movement	EBL	EBT	EBR	WBL	WBT	WBR	NBL	NBT	NBR	SBL	SBT	SBR
Lane Configurations		↑↑	↗		↑↑	↗				↘	↖	↗
Traffic Volume (vph)	0	1026	853	0	643	354	0	0	0	543	83	757
Future Volume (vph)	0	1026	853	0	643	354	0	0	0	543	83	757
Ideal Flow (vphpl)	1900	1900	1900	1900	1900	1900	1900	1900	1900	1900	1900	1900
Lane Width	12	12	12	12	12	12	12	12	12	12	12	16
Total Lost time (s)		4.0	4.0		4.0	3.0				4.0	4.0	4.0
Lane Util. Factor		0.95	1.00		0.95	1.00				0.95	0.95	1.00
Fr _t		1.00	0.85		1.00	0.85				1.00	1.00	0.85
Fl _t Protected		1.00	1.00		1.00	1.00				0.95	0.96	1.00
Satd. Flow (prot)		3505	1568		3505	1568				1603	1627	1711
Fl _t Permitted		1.00	1.00		1.00	1.00				0.95	0.96	1.00
Satd. Flow (perm)		3505	1568		3505	1568				1603	1627	1711
Peak-hour factor, PHF	0.97	0.97	0.97	0.97	0.97	0.97	0.97	0.97	0.97	0.97	0.97	0.97
Adj. Flow (vph)	0	1058	879	0	663	365	0	0	0	560	86	780
RTOR Reduction (vph)	0	0	0	0	0	0	0	0	0	0	0	80
Lane Group Flow (vph)	0	1058	879	0	663	365	0	0	0	319	327	700
Heavy Vehicles (%)	3%	3%	3%	3%	3%	3%	0%	0%	0%	7%	7%	7%
Turn Type		NA	Free		NA	Free				Split	NA	custom
Protected Phases		2			6					4	4	5
Permitted Phases			Free		6	Free						4
Actuated Green, G (s)		69.5	105.0		52.4	105.0				26.0	26.0	38.6
Effective Green, g (s)		70.5	105.0		53.4	105.0				26.5	26.5	39.6
Actuated g/C Ratio		0.67	1.00		0.51	1.00				0.25	0.25	0.38
Clearance Time (s)		5.0			5.0					4.5	4.5	4.5
Vehicle Extension (s)		4.1			4.1					2.3	2.3	2.3
Lane Grp Cap (vph)		2353	1568		1782	1568				404	410	710
v/s Ratio Prot		0.30			0.19					0.20	0.20	c0.12
v/s Ratio Perm			c0.56			0.23						0.29
v/c Ratio		0.45	0.56		0.37	0.23				0.79	0.80	0.99
Uniform Delay, d ₁		8.1	0.0		15.6	0.0				36.6	36.7	32.4
Progression Factor		0.97	1.00		1.05	1.00				1.00	1.00	1.00
Incremental Delay, d ₂		0.5	1.1		0.6	0.3				9.4	9.9	29.8
Delay (s)		8.4	1.1		17.1	0.3				46.0	46.6	62.3
Level of Service		A	A		B	A				D	D	E
Approach Delay (s)		5.1			11.1			0.0			55.0	
Approach LOS		A			B			A			E	
Intersection Summary												
HCM 2000 Control Delay			22.7									HCM 2000 Level of Service C
HCM 2000 Volume to Capacity ratio			0.81									
Actuated Cycle Length (s)			105.0							12.0		Sum of lost time (s)
Intersection Capacity Utilization			71.3%									ICU Level of Service C
Analysis Period (min)			15									

c Critical Lane Group

V/C Ratio calculated using HCM worksheet with correct critical movements and lost time

HCM 6th Signalized Intersection Summary

11: I-5 NB Ramps & SW Elligsen Road

06/24/2021

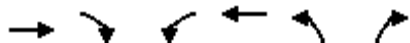

Movement	EBT	EBR	WBL	WBT	NBL	NBR
Lane Configurations	↑↑	↑		↑↑	↑↑	↑
Traffic Volume (veh/h)	919	653	0	702	296	223
Future Volume (veh/h)	919	653	0	702	296	223
Initial Q (Qb), veh	0	0	0	0	0	0
Ped-Bike Adj(A_pbT)		1.00	1.00		1.00	1.00
Parking Bus, Adj	1.00	1.00	1.00	1.00	1.00	1.00
Work Zone On Approach	No			No	No	
Adj Sat Flow, veh/h/ln	1841	1841	0	1885	1841	1841
Adj Flow Rate, veh/h	1010	0	0	771	325	0
Peak Hour Factor	0.91	0.91	0.91	0.91	0.91	0.91
Percent Heavy Veh, %	4	4	0	1	4	4
Cap, veh/h	2799		0	2867	420	
Arrive On Green	1.00	0.00	0.00	0.80	0.12	0.00
Sat Flow, veh/h	3589	1560	0	3770	3401	1560
Grp Volume(v), veh/h	1010	0	0	771	325	0
Grp Sat Flow(s),veh/h/ln	1749	1560	0	1791	1700	1560
Q Serve(g_s), s	0.0	0.0	0.0	5.8	9.7	0.0
Cycle Q Clear(g_c), s	0.0	0.0	0.0	5.8	9.7	0.0
Prop In Lane		1.00	0.00		1.00	1.00
Lane Grp Cap(c), veh/h	2799		0	2867	420	
V/C Ratio(X)	0.36		0.00	0.27	0.77	
Avail Cap(c_a), veh/h	2799		0	2867	1166	
HCM Platoon Ratio	2.00	2.00	1.00	1.00	1.00	1.00
Upstream Filter(l)	0.84	0.00	0.00	1.00	1.00	0.00
Uniform Delay (d), s/veh	0.0	0.0	0.0	2.7	44.6	0.0
Incr Delay (d2), s/veh	0.3	0.0	0.0	0.2	1.9	0.0
Initial Q Delay(d3),s/veh	0.0	0.0	0.0	0.0	0.0	0.0
%ile BackOfQ(50%),veh/ln	0.1	0.0	0.0	1.4	4.2	0.0
Unsig. Movement Delay, s/veh						
LnGrp Delay(d),s/veh	0.3	0.0	0.0	2.9	46.5	0.0
LnGrp LOS	A		A	A	D	
Approach Vol, veh/h	1010	A		771	325	A
Approach Delay, s/veh	0.3			2.9	46.5	
Approach LOS	A			A	D	
Timer - Assigned Phs		2			6	8
Phs Duration (G+Y+Rc), s		88.0			88.0	17.0
Change Period (Y+Rc), s		5.0			5.0	4.5
Max Green Setting (Gmax), s		60.0			60.0	35.5
Max Q Clear Time (g_c+I1), s		2.0			7.8	11.7
Green Ext Time (p_c), s		14.4			9.6	0.7

Intersection Summary

HCM 6th Ctrl Delay	8.4
HCM 6th LOS	A

Notes

Unsignalized Delay for [NBR, EBR] is excluded from calculations of the approach delay and intersection delay.

HCM 6th TWSC
12: SW Norwood Road & SW 89th Avenue

06/24/2021

Intersection						
Int Delay, s/veh	1.1					
Movement	EBL	EBT	WBT	WBR	SBL	SBR
Lane Configurations		↕	↕		↕	
Traffic Vol, veh/h	30	179	132	13	10	8
Future Vol, veh/h	30	179	132	13	10	8
Conflicting Peds, #/hr	2	0	0	2	2	2
Sign Control	Free	Free	Free	Free	Stop	Stop
RT Channelized	-	None	-	None	-	None
Storage Length	-	-	-	-	-	-
Veh in Median Storage, #	-	0	0	-	0	-
Grade, %	-	0	0	-	0	-
Peak Hour Factor	92	92	92	92	92	92
Heavy Vehicles, %	1	1	0	0	0	0
Mvmt Flow	33	195	143	14	11	9

Major/Minor	Major1	Major2	Minor2		
Conflicting Flow All	159	0	-	0	415 154
Stage 1	-	-	-	-	152 -
Stage 2	-	-	-	-	263 -
Critical Hdwy	4.11	-	-	-	6.4 6.2
Critical Hdwy Stg 1	-	-	-	-	5.4 -
Critical Hdwy Stg 2	-	-	-	-	5.4 -
Follow-up Hdwy	2.209	-	-	-	3.5 3.3
Pot Cap-1 Maneuver	1427	-	-	-	598 897
Stage 1	-	-	-	-	881 -
Stage 2	-	-	-	-	786 -
Platoon blocked, %		-	-	-	
Mov Cap-1 Maneuver	1424	-	-	-	580 894
Mov Cap-2 Maneuver	-	-	-	-	580 -
Stage 1	-	-	-	-	856 -
Stage 2	-	-	-	-	784 -

Approach	EB	WB	SB
HCM Control Delay, s	1.1	0	10.4
HCM LOS			B

Minor Lane/Major Mvmt	EBL	EBT	WBT	WBR	SBLn1
Capacity (veh/h)	1424	-	-	-	687
HCM Lane V/C Ratio	0.023	-	-	-	0.028
HCM Control Delay (s)	7.6	0	-	-	10.4
HCM Lane LOS	A	A	-	-	B
HCM 95th %tile Q(veh)	0.1	-	-	-	0.1

HCM 6th TWSC
 13: SW Norwood Road & SW Vermillion Drive

06/24/2021

Intersection						
Int Delay, s/veh	2.9					
Movement	EBL	EBT	WBT	WBR	SBL	SBR
Lane Configurations		↕	↕		↕	
Traffic Vol, veh/h	64	125	111	35	22	34
Future Vol, veh/h	64	125	111	35	22	34
Conflicting Peds, #/hr	0	0	0	0	0	0
Sign Control	Free	Free	Free	Free	Stop	Stop
RT Channelized	-	None	-	None	-	None
Storage Length	-	-	-	-	-	-
Veh in Median Storage, #	-	0	0	-	0	-
Grade, %	-	0	0	-	0	-
Peak Hour Factor	72	72	72	72	72	72
Heavy Vehicles, %	1	1	0	0	0	0
Mvmt Flow	89	174	154	49	31	47

Major/Minor	Major1	Major2	Minor2		
Conflicting Flow All	203	0	-	0	531 179
Stage 1	-	-	-	-	179 -
Stage 2	-	-	-	-	352 -
Critical Hdwy	4.11	-	-	-	6.4 6.2
Critical Hdwy Stg 1	-	-	-	-	5.4 -
Critical Hdwy Stg 2	-	-	-	-	5.4 -
Follow-up Hdwy	2.209	-	-	-	3.5 3.3
Pot Cap-1 Maneuver	1375	-	-	-	512 869
Stage 1	-	-	-	-	857 -
Stage 2	-	-	-	-	716 -
Platoon blocked, %		-	-	-	
Mov Cap-1 Maneuver	1375	-	-	-	475 869
Mov Cap-2 Maneuver	-	-	-	-	475 -
Stage 1	-	-	-	-	795 -
Stage 2	-	-	-	-	716 -

Approach	EB	WB	SB
HCM Control Delay, s	2.6	0	11.2
HCM LOS			B

Minor Lane/Major Mvmt	EBL	EBT	WBT	WBR	SBLn1
Capacity (veh/h)	1375	-	-	-	655
HCM Lane V/C Ratio	0.065	-	-	-	0.119
HCM Control Delay (s)	7.8	0	-	-	11.2
HCM Lane LOS	A	A	-	-	B
HCM 95th %tile Q(veh)	0.2	-	-	-	0.4

HCM 6th TWSC
 14: SW 82nd Avenue & SW Norwood Road/Driveway

06/24/2021

Intersection												
Int Delay, s/veh	6.8											
Movement	EBL	EBT	EBR	WBL	WBT	WBR	NBL	NBT	NBR	SBL	SBT	SBR
Lane Configurations		↕			↕			↕			↕	↗
Traffic Vol, veh/h	115	0	32	0	0	1	19	7	0	2	4	127
Future Vol, veh/h	115	0	32	0	0	1	19	7	0	2	4	127
Conflicting Peds, #/hr	0	0	0	0	0	0	0	0	0	0	0	0
Sign Control	Free	Free	Free	Free	Free	Free	Stop	Stop	Stop	Stop	Stop	Stop
RT Channelized	-	-	None	-	-	None	-	-	None	-	-	Free
Storage Length	-	-	-	-	-	-	-	-	-	-	-	15
Veh in Median Storage, #	-	0	-	-	0	-	-	0	-	-	0	-
Grade, %	-	0	-	-	0	-	-	0	-	-	0	-
Peak Hour Factor	83	83	83	83	83	83	83	83	83	83	83	83
Heavy Vehicles, %	0	0	0	0	0	0	0	0	0	0	0	0
Mvmt Flow	139	0	39	0	0	1	23	8	0	2	5	153

Major/Minor	Major1			Major2			Minor1			Minor2		
Conflicting Flow All	1	0	0	39	0	0	301	299	20	303	318	-
Stage 1	-	-	-	-	-	-	298	298	-	1	1	-
Stage 2	-	-	-	-	-	-	3	1	-	302	317	-
Critical Hdwy	4.1	-	-	4.1	-	-	7.1	6.5	6.2	7.1	6.5	-
Critical Hdwy Stg 1	-	-	-	-	-	-	6.1	5.5	-	6.1	5.5	-
Critical Hdwy Stg 2	-	-	-	-	-	-	6.1	5.5	-	6.1	5.5	-
Follow-up Hdwy	2.2	-	-	2.2	-	-	3.5	4	3.3	3.5	4	-
Pot Cap-1 Maneuver	1635	-	-	1584	-	-	655	616	1064	653	602	0
Stage 1	-	-	-	-	-	-	715	671	-	1027	899	0
Stage 2	-	-	-	-	-	-	1025	899	-	712	658	0
Platoon blocked, %	-	-	-	-	-	-	-	-	-	-	-	-
Mov Cap-1 Maneuver	1635	-	-	1584	-	-	607	562	1064	603	550	-
Mov Cap-2 Maneuver	-	-	-	-	-	-	607	562	-	603	550	-
Stage 1	-	-	-	-	-	-	653	613	-	938	899	-
Stage 2	-	-	-	-	-	-	1020	899	-	641	601	-

Approach	EB			WB			NB			SB		
HCM Control Delay, s	5.8			0			11.4			11.4		
HCM LOS							B			B		

Minor Lane/Major Mvmt	NBLn1	EBL	EBT	EBR	WBL	WBT	WBR	SBLn1	SBLn2
Capacity (veh/h)	594	1635	-	-	1584	-	-	567	-
HCM Lane V/C Ratio	0.053	0.085	-	-	-	-	-	0.013	-
HCM Control Delay (s)	11.4	7.4	0	-	0	-	-	11.4	0
HCM Lane LOS	B	A	A	-	A	-	-	B	A
HCM 95th %tile Q(veh)	0.2	0.3	-	-	0	-	-	0	-

HCM 6th TWSC
 15: SW 65th Avenue & SW Norwood Road

06/24/2021

Intersection						
Int Delay, s/veh	3					
Movement	EBL	EBR	NBL	NBT	SBT	SBR
Lane Configurations	T			T		
Traffic Vol, veh/h	61	58	51	206	366	103
Future Vol, veh/h	61	58	51	206	366	103
Conflicting Peds, #/hr	0	0	0	0	0	0
Sign Control	Stop	Stop	Free	Free	Free	Free
RT Channelized	-	None	-	None	-	None
Storage Length	-	-	-	-	-	-
Veh in Median Storage, #	0	-	-	0	0	-
Grade, %	0	-	-	0	0	-
Peak Hour Factor	89	89	89	89	89	89
Heavy Vehicles, %	0	0	2	2	0	0
Mvmt Flow	69	65	57	231	411	116

Major/Minor	Minor2	Major1	Major2			
Conflicting Flow All	814	469	527	0	-	0
Stage 1	469	-	-	-	-	-
Stage 2	345	-	-	-	-	-
Critical Hdwy	6.4	6.2	4.12	-	-	-
Critical Hdwy Stg 1	5.4	-	-	-	-	-
Critical Hdwy Stg 2	5.4	-	-	-	-	-
Follow-up Hdwy	3.5	3.3	2.218	-	-	-
Pot Cap-1 Maneuver	350	598	1040	-	-	-
Stage 1	634	-	-	-	-	-
Stage 2	722	-	-	-	-	-
Platoon blocked, %				-	-	-
Mov Cap-1 Maneuver	328	598	1040	-	-	-
Mov Cap-2 Maneuver	328	-	-	-	-	-
Stage 1	594	-	-	-	-	-
Stage 2	722	-	-	-	-	-

Approach	EB	NB	SB
HCM Control Delay, s	17.5	1.7	0
HCM LOS	C		

Minor Lane/Major Mvmt	NBL	NBT	EBLn1	SBT	SBR
Capacity (veh/h)	1040	-	421	-	-
HCM Lane V/C Ratio	0.055	-	0.318	-	-
HCM Control Delay (s)	8.7	0	17.5	-	-
HCM Lane LOS	A	A	C	-	-
HCM 95th %tile Q(veh)	0.2	-	1.3	-	-

HCM 6th Signalized Intersection Summary

1: SW Boones Ferry Rd & SW Sagert St

08/31/2021



Movement	EBL	EBT	EBR	WBL	WBT	WBR	NBL	NBT	NBR	SBL	SBT	SBR
Lane Configurations												
Traffic Volume (veh/h)	70	77	12	176	99	60	7	587	277	51	268	47
Future Volume (veh/h)	70	77	12	176	99	60	7	587	277	51	268	47
Initial Q (Qb), veh	0	0	0	0	0	0	0	0	0	0	0	0
Ped-Bike Adj(A_pbT)	1.00		0.99	1.00		1.00	1.00		0.98	1.00		0.98
Parking Bus, Adj	1.00	1.00	1.00	1.00	1.00	1.00	1.00	1.00	1.00	1.00	1.00	1.00
Work Zone On Approach		No			No			No			No	
Adj Sat Flow, veh/h/ln	1885	1885	1885	1900	1900	1900	1885	1885	1885	1811	1811	1811
Adj Flow Rate, veh/h	77	85	8	193	109	44	8	645	288	56	295	30
Peak Hour Factor	0.91	0.91	0.91	0.91	0.91	0.91	0.91	0.91	0.91	0.91	0.91	0.91
Percent Heavy Veh, %	1	1	1	0	0	0	1	1	1	6	6	6
Cap, veh/h	260	136	13	337	182	74	668	708	316	220	1104	915
Arrive On Green	0.06	0.08	0.07	0.12	0.14	0.14	0.02	0.58	0.57	0.05	0.61	0.61
Sat Flow, veh/h	1795	1696	160	1810	1285	519	1795	1225	547	1725	1811	1501
Grp Volume(v), veh/h	77	0	93	193	0	153	8	0	933	56	295	30
Grp Sat Flow(s),veh/h/ln	1795	0	1855	1810	0	1804	1795	0	1772	1725	1811	1501
Q Serve(g_s), s	3.5	0.0	4.4	8.5	0.0	7.3	0.2	0.0	42.9	1.1	6.9	0.7
Cycle Q Clear(g_c), s	3.5	0.0	4.4	8.5	0.0	7.3	0.2	0.0	42.9	1.1	6.9	0.7
Prop In Lane	1.00		0.09	1.00		0.29	1.00		0.31	1.00		1.00
Lane Grp Cap(c), veh/h	260	0	149	337	0	256	668	0	1024	220	1104	915
V/C Ratio(X)	0.30	0.00	0.63	0.57	0.00	0.60	0.01	0.00	0.91	0.26	0.27	0.03
Avail Cap(c_a), veh/h	373	0	325	339	0	316	856	0	1088	346	1112	921
HCM Platoon Ratio	1.00	1.00	1.00	1.00	1.00	1.00	1.00	1.00	1.00	1.00	1.00	1.00
Upstream Filter(I)	1.00	0.00	1.00	1.00	0.00	1.00	1.00	0.00	1.00	1.00	1.00	1.00
Uniform Delay (d), s/veh	35.4	0.0	40.7	31.2	0.0	36.8	7.9	0.0	17.3	18.1	8.3	7.1
Incr Delay (d2), s/veh	0.2	0.0	1.6	1.5	0.0	0.8	0.0	0.0	11.5	0.2	0.2	0.0
Initial Q Delay(d3),s/veh	0.0	0.0	0.0	0.0	0.0	0.0	0.0	0.0	0.0	0.0	0.0	0.0
%ile BackOfQ(50%),veh/ln	1.5	0.0	2.1	3.8	0.0	3.2	0.1	0.0	18.8	0.6	2.5	0.2
Unsig. Movement Delay, s/veh												
LnGrp Delay(d),s/veh	35.7	0.0	42.3	32.7	0.0	37.6	7.9	0.0	28.8	18.3	8.5	7.1
LnGrp LOS	D	A	D	C	A	D	A	A	C	B	A	A
Approach Vol, veh/h		170			346			941			381	
Approach Delay, s/veh		39.3			34.9			28.6			9.9	
Approach LOS		D			C			C			A	
Timer - Assigned Phs	1	2	3	4	5	6	7	8				
Phs Duration (G+Y+Rc), s	8.3	56.7	14.9	11.3	5.4	59.6	9.3	16.9				
Change Period (Y+Rc), s	4.5	5.0	4.5	4.5	4.5	5.0	4.5	4.5				
Max Green Setting (Gmax), s	10.5	55.0	10.5	15.5	10.5	55.0	10.5	15.5				
Max Q Clear Time (g_c+I1), s	3.1	44.9	10.5	6.4	2.2	8.9	5.5	9.3				
Green Ext Time (p_c), s	0.0	6.9	0.0	0.2	0.0	3.6	0.0	0.2				

Intersection Summary

HCM 6th Ctrl Delay	26.9
HCM 6th LOS	C

Notes

User approved pedestrian interval to be less than phase max green.

HCM 6th Signalized Intersection Summary

2: SW Boones Ferry Rd & SW Avery St

08/31/2021



Movement	EBL	EBT	EBR	WBL	WBT	WBR	NBL	NBT	NBR	SBL	SBT	SBR
Lane Configurations												
Traffic Volume (veh/h)	172	68	141	30	103	15	250	685	40	6	296	154
Future Volume (veh/h)	172	68	141	30	103	15	250	685	40	6	296	154
Initial Q (Qb), veh	0	0	0	0	0	0	0	0	0	0	0	0
Ped-Bike Adj(A_pbT)	0.99		0.97	0.99		0.96	1.00		0.98	1.00		1.00
Parking Bus, Adj	1.00	1.00	1.00	1.00	1.00	1.00	1.00	1.00	1.00	1.00	1.00	1.00
Work Zone On Approach		No			No			No			No	
Adj Sat Flow, veh/h/ln	1841	1841	1841	1841	1841	1841	1767	1767	1767	1841	1841	1841
Adj Flow Rate, veh/h	205	81	97	36	123	12	298	815	42	7	352	165
Peak Hour Factor	0.84	0.84	0.84	0.84	0.84	0.84	0.84	0.84	0.84	0.84	0.84	0.84
Percent Heavy Veh, %	4	4	4	4	4	4	9	9	9	4	4	4
Cap, veh/h	331	149	179	248	179	17	442	953	49	191	607	285
Arrive On Green	0.12	0.20	0.19	0.03	0.11	0.10	0.07	0.57	0.56	0.01	0.51	0.51
Sat Flow, veh/h	1753	749	897	1753	1644	160	1682	1663	86	1753	1184	555
Grp Volume(v), veh/h	205	0	178	36	0	135	298	0	857	7	0	517
Grp Sat Flow(s),veh/h/ln	1753	0	1647	1753	0	1804	1682	0	1749	1753	0	1739
Q Serve(g_s), s	8.7	0.0	8.4	1.6	0.0	6.2	6.0	0.0	35.5	0.2	0.0	17.8
Cycle Q Clear(g_c), s	8.7	0.0	8.4	1.6	0.0	6.2	6.0	0.0	35.5	0.2	0.0	17.8
Prop In Lane	1.00		0.54	1.00		0.09	1.00		0.05	1.00		0.32
Lane Grp Cap(c), veh/h	331	0	328	248	0	197	442	0	1003	191	0	892
V/C Ratio(X)	0.62	0.00	0.54	0.15	0.00	0.69	0.67	0.00	0.85	0.04	0.00	0.58
Avail Cap(c_a), veh/h	540	0	495	311	0	229	442	0	1335	297	0	1327
HCM Platoon Ratio	1.00	1.00	1.00	1.00	1.00	1.00	1.00	1.00	1.00	1.00	1.00	1.00
Upstream Filter(I)	1.00	0.00	1.00	1.00	0.00	1.00	1.00	0.00	1.00	1.00	0.00	1.00
Uniform Delay (d), s/veh	28.4	0.0	31.3	33.4	0.0	37.2	15.3	0.0	15.5	16.0	0.0	14.6
Incr Delay (d2), s/veh	0.7	0.0	0.5	0.1	0.0	4.7	3.3	0.0	5.0	0.0	0.0	0.9
Initial Q Delay(d3),s/veh	0.0	0.0	0.0	0.0	0.0	0.0	0.0	0.0	0.0	0.0	0.0	0.0
%ile BackOfQ(50%),veh/ln	3.6	0.0	3.3	0.7	0.0	3.0	2.9	0.0	13.8	0.1	0.0	6.7
Unsig. Movement Delay, s/veh												
LnGrp Delay(d),s/veh	29.1	0.0	31.9	33.5	0.0	41.9	18.7	0.0	20.4	16.0	0.0	15.5
LnGrp LOS	C	A	C	C	A	D	B	A	C	B	A	B
Approach Vol, veh/h		383			171			1155			524	
Approach Delay, s/veh		30.4			40.1			20.0			15.5	
Approach LOS		C			D			B			B	
Timer - Assigned Phs	1	2	3	4	5	6	7	8				
Phs Duration (G+Y+Rc), s	4.8	53.6	6.9	21.2	10.0	48.4	14.7	13.4				
Change Period (Y+Rc), s	4.0	5.5	4.0	5.0	4.0	5.5	4.0	5.0				
Max Green Setting (Gmax), s	6.0	64.5	6.0	25.0	6.0	64.5	21.0	10.0				
Max Q Clear Time (g_c+1/2), s	12.2	37.5	3.6	10.4	8.0	19.8	10.7	8.2				
Green Ext Time (p_c), s	0.0	10.6	0.0	0.6	0.0	6.0	0.1	0.1				

Intersection Summary

HCM 6th Ctrl Delay	22.2
HCM 6th LOS	C

Notes

User approved pedestrian interval to be less than phase max green.

HCM 6th Signalized Intersection Summary
 3: SW Boones Ferry Road & SW Ibach Street/SW Ibach Court

08/31/2021



Movement	EBL	EBT	EBR	WBL	WBT	WBR	NBL	NBT	NBR	SBL	SBT	SBR
Lane Configurations												
Traffic Volume (veh/h)	252	4	331	4	1	18	129	705	10	3	379	84
Future Volume (veh/h)	252	4	331	4	1	18	129	705	10	3	379	84
Initial Q (Qb), veh	0	0	0	0	0	0	0	0	0	0	0	0
Ped-Bike Adj(A_pbT)	0.98		0.99	1.00		0.97	1.00		0.99	1.00		0.99
Parking Bus, Adj	1.00	1.00	1.00	1.00	1.00	1.00	1.00	1.00	1.00	1.00	1.00	1.00
Work Zone On Approach		No			No			No			No	
Adj Sat Flow, veh/h/ln	1856	1856	1856	1900	1900	1900	1796	1796	1796	1811	1811	1811
Adj Flow Rate, veh/h	290	5	208	5	1	10	148	810	11	3	436	51
Peak Hour Factor	0.87	0.87	0.87	0.87	0.87	0.87	0.87	0.87	0.87	0.87	0.87	0.87
Percent Heavy Veh, %	3	3	3	0	0	0	7	7	7	6	6	6
Cap, veh/h	436	10	432	138	52	211	183	977	13	6	813	685
Arrive On Green	0.28	0.28	0.28	0.28	0.28	0.28	0.11	0.55	0.54	0.00	0.45	0.45
Sat Flow, veh/h	1360	37	1527	263	184	746	1711	1768	24	1725	1811	1526
Grp Volume(v), veh/h	290	0	213	16	0	0	148	0	821	3	436	51
Grp Sat Flow(s),veh/h/ln	1360	0	1564	1193	0	0	1711	0	1792	1725	1811	1526
Q Serve(g_s), s	9.1	0.0	8.5	0.0	0.0	0.0	6.3	0.0	28.1	0.1	13.0	1.4
Cycle Q Clear(g_c), s	17.6	0.0	8.5	8.5	0.0	0.0	6.3	0.0	28.1	0.1	13.0	1.4
Prop In Lane	1.00		0.98	0.31		0.62	1.00		0.01	1.00		1.00
Lane Grp Cap(c), veh/h	436	0	442	393	0	0	183	0	990	6	813	685
V/C Ratio(X)	0.67	0.00	0.48	0.04	0.00	0.00	0.81	0.00	0.83	0.54	0.54	0.07
Avail Cap(c_a), veh/h	527	0	547	489	0	0	253	0	1349	255	1363	1149
HCM Platoon Ratio	1.00	1.00	1.00	1.00	1.00	1.00	1.00	1.00	1.00	1.00	1.00	1.00
Upstream Filter(I)	1.00	0.00	1.00	1.00	0.00	0.00	1.00	0.00	1.00	1.00	1.00	1.00
Uniform Delay (d), s/veh	26.2	0.0	22.4	19.6	0.0	0.0	32.5	0.0	13.7	37.0	14.9	11.7
Incr Delay (d2), s/veh	1.8	0.0	0.5	0.0	0.0	0.0	10.4	0.0	4.1	41.4	0.9	0.1
Initial Q Delay(d3),s/veh	0.0	0.0	0.0	0.0	0.0	0.0	0.0	0.0	0.0	0.0	0.0	0.0
%ile BackOfQ(50%),veh/ln	4.9	0.0	3.0	0.2	0.0	0.0	3.0	0.0	10.4	0.1	4.9	0.5
Unsig. Movement Delay, s/veh												
LnGrp Delay(d),s/veh	27.9	0.0	22.9	19.6	0.0	0.0	42.8	0.0	17.8	78.4	15.7	11.8
LnGrp LOS	C	A	C	B	A	A	D	A	B	E	B	B
Approach Vol, veh/h		503			16			969			490	
Approach Delay, s/veh		25.8			19.6			21.6			15.7	
Approach LOS		C			B			C			B	
Timer - Assigned Phs	1	2		4	5	6		8				
Phs Duration (G+Y+Rc), s	4.2	45.1		25.0	12.0	37.4		25.0				
Change Period (Y+Rc), s	4.0	5.0		4.5	4.0	5.0		4.5				
Max Green Setting (Gmax), s	1.0	55.0		25.5	11.0	55.0		25.5				
Max Q Clear Time (g_c+1/2, s)	1.0	30.1		19.6	8.3	15.0		10.5				
Green Ext Time (p_c), s	0.0	10.0		0.9	0.1	5.2		0.0				

Intersection Summary

HCM 6th Ctrl Delay	21.2
HCM 6th LOS	C

HCM 6th TWSC
4: SW Boones Ferry Road & SW Iowa Drive

08/31/2021

Intersection												
Int Delay, s/veh	8.2											
Movement	EBL	EBT	EBR	WBL	WBT	WBR	NBL	NBT	NBR	SBL	SBT	SBR
Lane Configurations		↕			↕		↕	↕		↕	↕	
Traffic Vol, veh/h	49	2	54	29	0	31	14	649	10	19	436	17
Future Vol, veh/h	49	2	54	29	0	31	14	649	10	19	436	17
Conflicting Peds, #/hr	13	0	5	1	0	9	5	0	1	9	0	13
Sign Control	Stop	Stop	Stop	Stop	Stop	Stop	Free	Free	Free	Free	Free	Free
RT Channelized	-	-	None	-	-	None	-	-	None	-	-	None
Storage Length	-	-	-	-	-	-	95	-	-	105	-	-
Veh in Median Storage, #	-	0	-	-	0	-	-	0	-	-	0	-
Grade, %	-	0	-	-	0	-	-	0	-	-	0	-
Peak Hour Factor	84	84	84	84	84	84	84	84	84	84	84	84
Heavy Vehicles, %	0	0	0	0	0	0	7	7	7	6	6	6
Mvmt Flow	58	2	64	35	0	37	17	773	12	23	519	20

Major/Minor	Minor2		Minor1		Major1			Major2				
Conflicting Flow All	1433	1416	547	1435	1420	801	552	0	0	794	0	0
Stage 1	588	588	-	822	822	-	-	-	-	-	-	-
Stage 2	845	828	-	613	598	-	-	-	-	-	-	-
Critical Hdwy	7.1	6.5	6.2	7.1	6.5	6.2	4.17	-	-	4.16	-	-
Critical Hdwy Stg 1	6.1	5.5	-	6.1	5.5	-	-	-	-	-	-	-
Critical Hdwy Stg 2	6.1	5.5	-	6.1	5.5	-	-	-	-	-	-	-
Follow-up Hdwy	3.5	4	3.3	3.5	4	3.3	2.263	-	-	2.254	-	-
Pot Cap-1 Maneuver	113	139	541	113	138	388	993	-	-	810	-	-
Stage 1	499	499	-	371	391	-	-	-	-	-	-	-
Stage 2	360	389	-	483	494	-	-	-	-	-	-	-
Platoon blocked, %								-	-	-	-	-
Mov Cap-1 Maneuver	96	130	532	93	129	380	981	-	-	803	-	-
Mov Cap-2 Maneuver	96	130	-	93	129	-	-	-	-	-	-	-
Stage 1	485	479	-	361	381	-	-	-	-	-	-	-
Stage 2	315	379	-	408	474	-	-	-	-	-	-	-

Approach	EB		WB		NB		SB	
HCM Control Delay, s	72.3		47.6		0.2		0.4	
HCM LOS	F		E					

Minor Lane/Major Mvmt	NBL	NBT	NBR	EBLn1WBLn1	SBL	SBT	SBR
Capacity (veh/h)	981	-	-	167	153	803	-
HCM Lane V/C Ratio	0.017	-	-	0.749	0.467	0.028	-
HCM Control Delay (s)	8.7	-	-	72.3	47.6	9.6	-
HCM Lane LOS	A	-	-	F	E	A	-
HCM 95th %tile Q(veh)	0.1	-	-	4.7	2.2	0.1	-

HCM 6th TWSC
5: SW Boones Ferry Road & SW Norwood Road

08/31/2021

Intersection						
Int Delay, s/veh	2.8					
Movement	WBL	WBR	NBT	NBR	SBL	SBT
Lane Configurations	Y		↑	↑	↑	↑
Traffic Vol, veh/h	74	58	614	30	51	467
Future Vol, veh/h	74	58	614	30	51	467
Conflicting Peds, #/hr	4	4	0	4	4	0
Sign Control	Stop	Stop	Free	Free	Free	Free
RT Channelized	-	None	-	None	-	None
Storage Length	-	-	-	65	290	-
Veh in Median Storage, #	0	-	0	-	-	0
Grade, %	0	-	0	-	-	0
Peak Hour Factor	87	87	87	87	87	87
Heavy Vehicles, %	2	2	6	6	5	5
Mvmt Flow	85	67	706	34	59	537

Major/Minor	Minor1	Major1	Major2		
Conflicting Flow All	1369	714	0	0	744
Stage 1	710	-	-	-	-
Stage 2	659	-	-	-	-
Critical Hdwy	6.42	6.22	-	-	4.15
Critical Hdwy Stg 1	5.42	-	-	-	-
Critical Hdwy Stg 2	5.42	-	-	-	-
Follow-up Hdwy	3.518	3.318	-	-	2.245
Pot Cap-1 Maneuver	162	431	-	-	850
Stage 1	487	-	-	-	-
Stage 2	515	-	-	-	-
Platoon blocked, %			-	-	-
Mov Cap-1 Maneuver	150	428	-	-	847
Mov Cap-2 Maneuver	288	-	-	-	-
Stage 1	485	-	-	-	-
Stage 2	477	-	-	-	-

Approach	WB	NB	SB
HCM Control Delay, s	24.2	0	0.9
HCM LOS	C		

Minor Lane/Major Mvmt	NBT	NBRWBLn1	SBL	SBT
Capacity (veh/h)	-	-	336	847
HCM Lane V/C Ratio	-	-	0.452	0.069
HCM Control Delay (s)	-	-	24.2	9.6
HCM Lane LOS	-	-	C	A
HCM 95th %tile Q(veh)	-	-	2.2	0.2

HCM 6th TWSC
 7: SW Boones Ferry Road & SW Greenhill Lane

08/31/2021

Intersection						
Int Delay, s/veh	0					
Movement	WBL	WBR	NBT	NBR	SBL	SBT
Lane Configurations	↔		↔		↔	↔
Traffic Vol, veh/h	2	1	646	0	0	543
Future Vol, veh/h	2	1	646	0	0	543
Conflicting Peds, #/hr	4	4	0	4	4	0
Sign Control	Stop	Stop	Free	Free	Free	Free
RT Channelized	-	None	-	None	-	None
Storage Length	-	-	-	-	150	-
Veh in Median Storage, #	2	-	0	-	-	0
Grade, %	0	-	0	-	-	0
Peak Hour Factor	87	87	87	87	87	87
Heavy Vehicles, %	0	0	6	6	5	5
Mvmt Flow	2	1	743	0	0	624

Major/Minor	Minor1	Major1	Major2		
Conflicting Flow All	1375	751	0	0	747
Stage 1	747	-	-	-	-
Stage 2	628	-	-	-	-
Critical Hdwy	6.4	6.2	-	-	4.15
Critical Hdwy Stg 1	5.4	-	-	-	-
Critical Hdwy Stg 2	5.4	-	-	-	-
Follow-up Hdwy	3.5	3.3	-	-	2.245
Pot Cap-1 Maneuver	162	414	-	-	848
Stage 1	472	-	-	-	-
Stage 2	536	-	-	-	-
Platoon blocked, %			-	-	-
Mov Cap-1 Maneuver	161	411	-	-	845
Mov Cap-2 Maneuver	366	-	-	-	-
Stage 1	470	-	-	-	-
Stage 2	534	-	-	-	-

Approach	WB	NB	SB
HCM Control Delay, s	14.6	0	0
HCM LOS	B		

Minor Lane/Major Mvmt	NBT	NBRWBLn1	SBL	SBT
Capacity (veh/h)	-	-	380	845
HCM Lane V/C Ratio	-	-	0.009	-
HCM Control Delay (s)	-	-	14.6	0
HCM Lane LOS	-	-	B	A
HCM 95th %tile Q(veh)	-	-	0	0

HCM 6th Signalized Intersection Summary

8: SW Boones Ferry Road & SW Day Road

08/31/2021



Movement	EBL	EBT	EBR	WBL	WBT	WBR	NBL	NBT	NBR	SBL	SBT	SBR
Lane Configurations		↖	↗		↔		↖↗	↖		↗	↖↗	
Traffic Volume (veh/h)	172	0	560	0	0	0	619	474	0	0	493	50
Future Volume (veh/h)	172	0	560	0	0	0	619	474	0	0	493	50
Initial Q (Qb), veh	0	0	0	0	0	0	0	0	0	0	0	0
Ped-Bike Adj(A_pbT)	1.00		1.00	1.00		1.00	1.00		1.00	1.00		1.00
Parking Bus, Adj	1.00	1.00	1.00	1.00	1.00	1.00	1.00	1.00	1.00	1.00	1.00	1.00
Work Zone On Approach		No			No			No			No	
Adj Sat Flow, veh/h/ln	1693	1693	1693	1900	1900	1900	1693	1693	1693	1796	1796	1796
Adj Flow Rate, veh/h	191	0	572	0	0	0	688	527	0	0	548	45
Peak Hour Factor	0.90	0.90	0.90	0.90	0.90	0.90	0.90	0.90	0.90	0.90	0.90	0.90
Percent Heavy Veh, %	14	14	14	0	0	0	14	14	14	7	7	7
Cap, veh/h	288	0	662	0	320	0	791	673	0	510	1300	107
Arrive On Green	0.16	0.00	0.17	0.00	0.00	0.00	0.10	0.13	0.00	0.00	0.41	0.39
Sat Flow, veh/h	1283	0	1434	0	1900	0	2740	1693	0	1711	3194	262
Grp Volume(v), veh/h	191	0	572	0	0	0	688	527	0	0	292	301
Grp Sat Flow(s),veh/h/ln	1283	0	1434	0	1900	0	1370	1693	0	1711	1706	1749
Q Serve(g_s), s	13.9	0.0	16.2	0.0	0.0	0.0	23.5	28.6	0.0	0.0	11.6	11.7
Cycle Q Clear(g_c), s	13.9	0.0	16.2	0.0	0.0	0.0	23.5	28.6	0.0	0.0	11.6	11.7
Prop In Lane	1.00		1.00	0.00		0.00	1.00		0.00	1.00		0.15
Lane Grp Cap(c), veh/h	285	0	662	0	320	0	791	673	0	510	694	712
V/C Ratio(X)	0.67	0.00	0.86	0.00	0.00	0.00	0.87	0.78	0.00	0.00	0.42	0.42
Avail Cap(c_a), veh/h	285	0	662	0	320	0	1041	1033	0	510	694	712
HCM Platoon Ratio	1.00	1.00	1.00	1.00	1.00	1.00	0.33	0.33	0.33	1.00	1.00	1.00
Upstream Filter(I)	1.00	0.00	1.00	0.00	0.00	0.00	0.90	0.90	0.00	0.00	1.00	1.00
Uniform Delay (d), s/veh	39.0	0.0	22.9	0.0	0.0	0.0	41.2	37.3	0.0	0.0	20.2	20.3
Incr Delay (d2), s/veh	5.5	0.0	11.3	0.0	0.0	0.0	5.1	8.0	0.0	0.0	1.9	1.8
Initial Q Delay(d3),s/veh	0.0	0.0	0.0	0.0	0.0	0.0	0.0	0.0	0.0	0.0	0.0	0.0
%ile BackOfQ(50%),veh/ln	4.6	0.0	12.4	0.0	0.0	0.0	9.1	14.4	0.0	0.0	4.6	4.8
Unsig. Movement Delay, s/veh												
LnGrp Delay(d),s/veh	44.5	0.0	34.2	0.0	0.0	0.0	46.3	45.3	0.0	0.0	22.0	22.1
LnGrp LOS	D	A	C	A	A	A	D	D	A	A	C	C
Approach Vol, veh/h		763			0			1215			593	
Approach Delay, s/veh		36.8			0.0			45.9			22.1	
Approach LOS		D						D			C	
Timer - Assigned Phs	1	2		4	5	6		8				
Phs Duration (G+Y+Rc), s	32.3	42.7		20.0	33.2	41.8		20.0				
Change Period (Y+Rc), s	* 5.4	* 5.4		4.5	* 5.4	* 5.4		4.5				
Max Green Setting (Gmax), s	* 36	* 29		15.5	* 8.5	* 57		15.5				
Max Q Clear Time (g_c+I1), s	25.5	13.7		0.0	0.0	30.6		18.2				
Green Ext Time (p_c), s	1.4	4.4		0.0	0.0	5.7		0.0				

Intersection Summary

HCM 6th Ctrl Delay	37.7
HCM 6th LOS	D

Notes

User approved pedestrian interval to be less than phase max green.

* HCM 6th computational engine requires equal clearance times for the phases crossing the barrier.

HCM 6th Signalized Intersection Summary
 9: SW Elligsen Road/SW Boones Ferry Road & SW 95th Avenue

08/31/2021



Movement	EBL	EBT	EBR	WBL	WBT	WBR	NBL	NBT	NBR	SBL	SBT	SBR
Lane Configurations		↕	↗	↖	↗	↖	↗	↖		↖	↗	↖
Traffic Volume (veh/h)	200	7	540	16	1	6	815	808	68	5	705	263
Future Volume (veh/h)	200	7	540	16	1	6	815	808	68	5	705	263
Initial Q (Qb), veh	0	0	0	0	0	0	0	0	0	0	0	0
Ped-Bike Adj(A_pbT)	1.00		0.99	1.00		1.00	1.00		1.00	1.00		1.00
Parking Bus, Adj	1.00	1.00	1.00	1.00	1.00	1.00	1.00	1.00	1.00	1.00	1.00	1.00
Work Zone On Approach		No		No		No		No		No		No
Adj Sat Flow, veh/h/ln	1648	1648	1648	1737	1737	1737	1796	1796	1796	1737	1737	1737
Adj Flow Rate, veh/h	217	8	549	17	1	7	886	878	74	5	766	0
Peak Hour Factor	0.92	0.92	0.92	0.92	0.92	0.92	0.92	0.92	0.92	0.92	0.92	0.92
Percent Heavy Veh, %	17	17	17	11	11	11	7	7	7	11	11	11
Cap, veh/h	297	8	1198	80	35	248	992	1168	98	473	1168	
Arrive On Green	0.19	0.19	0.19	0.19	0.19	0.19	0.50	0.61	0.61	0.09	0.12	0.00
Sat Flow, veh/h	1175	43	2445	791	187	1309	3319	3185	268	1654	3300	1472
Grp Volume(v), veh/h	225	0	549	17	0	8	886	470	482	5	766	0
Grp Sat Flow(s),veh/h/ln	1219	0	1223	791	0	1496	1659	1706	1748	1654	1650	1472
Q Serve(g_s), s	17.0	0.0	14.1	0.5	0.0	0.4	22.9	18.8	18.8	0.3	21.1	0.0
Cycle Q Clear(g_c), s	17.5	0.0	14.1	18.0	0.0	0.4	22.9	18.8	18.8	0.3	21.1	0.0
Prop In Lane	0.96		1.00	1.00		0.88	1.00		0.15	1.00		1.00
Lane Grp Cap(c), veh/h	305	0	1198	80	0	284	992	625	641	473	1168	
V/C Ratio(X)	0.74	0.00	0.46	0.21	0.00	0.03	0.89	0.75	0.75	0.01	0.66	
Avail Cap(c_a), veh/h	305	0	1198	80	0	284	1572	988	1012	473	1168	
HCM Platoon Ratio	1.00	1.00	1.00	1.00	1.00	1.00	1.67	1.67	1.67	0.33	0.33	0.33
Upstream Filter(I)	1.00	0.00	1.00	1.00	0.00	1.00	0.28	0.28	0.28	0.74	0.74	0.00
Uniform Delay (d), s/veh	38.5	0.0	16.0	47.4	0.0	31.4	22.4	15.3	15.3	30.8	36.4	0.0
Incr Delay (d2), s/veh	8.6	0.0	0.2	1.0	0.0	0.0	1.3	2.4	2.3	0.0	2.1	0.0
Initial Q Delay(d3),s/veh	0.0	0.0	0.0	0.0	0.0	0.0	0.0	0.0	0.0	0.0	0.0	0.0
%ile BackOfQ(50%),veh/ln	5.8	0.0	3.8	0.4	0.0	0.2	6.6	5.1	5.2	0.1	9.6	0.0
Unsig. Movement Delay, s/veh												
LnGrp Delay(d),s/veh	47.1	0.0	16.2	48.4	0.0	31.4	23.7	17.7	17.7	30.8	38.6	0.0
LnGrp LOS	D	A	B	D	A	C	C	B	B	C	D	
Approach Vol, veh/h		774			25		1838			771		A
Approach Delay, s/veh		25.2			43.0		20.6			38.5		
Approach LOS		C			D		C			D		
Timer - Assigned Phs	1	2		4	5	6		8				
Phs Duration (G+Y+Rc), s	33.4	38.6		23.0	32.2	39.8		23.0				
Change Period (Y+Rc), s	5.0	5.0		5.0	5.0	5.0		5.0				
Max Green Setting (Gmax), s	45.0	17.0		18.0	7.0	55.0		18.0				
Max Q Clear Time (g_c+Q), s	24.5	23.1		20.0	2.3	20.8		19.5				
Green Ext Time (p_c), s	3.5	0.0		0.0	0.0	14.0		0.0				

Intersection Summary

HCM 6th Ctrl Delay	25.9
HCM 6th LOS	C

Notes

- User approved pedestrian interval to be less than phase max green.
- Unsignalized Delay for [SBR] is excluded from calculations of the approach delay and intersection delay.

HCM Signalized Intersection Capacity Analysis
 10: I-5 SB Ramps & SW Elligsen Road

08/31/2021



Movement	EBL	EBT	EBR	WBL	WBT	WBR	NBL	NBT	NBR	SBL	SBT	SBR
Lane Configurations		↑↑	↗		↑↑	↗				↘	↖	↗
Traffic Volume (vph)	0	917	343	0	712	117	0	0	0	520	0	976
Future Volume (vph)	0	917	343	0	712	117	0	0	0	520	0	976
Ideal Flow (vphpl)	1900	1900	1900	1900	1900	1900	1900	1900	1900	1900	1900	1900
Lane Width	12	12	12	12	12	12	12	12	12	12	12	16
Total Lost time (s)		4.0	4.0		4.0	4.0				4.0	4.0	4.0
Lane Util. Factor		0.95	1.00		0.95	1.00				0.95	0.95	1.00
Frbp, ped/bikes		1.00	0.99		1.00	1.00				1.00	1.00	1.00
Flpb, ped/bikes		1.00	1.00		1.00	1.00				1.00	1.00	1.00
Frt		1.00	0.85		1.00	0.85				1.00	1.00	0.85
Flt Protected		1.00	1.00		1.00	1.00				0.95	0.95	1.00
Satd. Flow (prot)		3034	1340		3406	1524				1573	1573	1679
Flt Permitted		1.00	1.00		1.00	1.00				0.95	0.95	1.00
Satd. Flow (perm)		3034	1340		3406	1524				1573	1573	1679
Peak-hour factor, PHF	0.94	0.94	0.94	0.94	0.94	0.94	0.94	0.94	0.94	0.94	0.94	0.94
Adj. Flow (vph)	0	976	365	0	757	124	0	0	0	553	0	1038
RTOR Reduction (vph)	0	0	0	0	0	0	0	0	0	0	0	8
Lane Group Flow (vph)	0	976	365	0	757	124	0	0	0	276	277	1030
Confl. Peds. (#/hr)			2									
Heavy Vehicles (%)	19%	19%	19%	6%	6%	6%	0%	0%	0%	9%	9%	9%
Turn Type		NA	Free		NA	Free				Split	NA	custom
Protected Phases		2			6					4	4	5
Permitted Phases			Free		6	Free						4
Actuated Green, G (s)		64.9	95.0		22.0	95.0				20.6	20.6	59.0
Effective Green, g (s)		65.9	95.0		23.0	95.0				21.1	21.1	60.0
Actuated g/C Ratio		0.69	1.00		0.24	1.00				0.22	0.22	0.63
Clearance Time (s)		5.0			5.0					4.5	4.5	4.5
Vehicle Extension (s)		4.1			4.1					2.3	2.3	2.3
Lane Grp Cap (vph)		2104	1340		824	1524				349	349	1131
v/s Ratio Prot		0.32			c0.22					0.18	0.18	c0.37
v/s Ratio Perm			0.27			0.08						0.24
v/c Ratio		0.46	0.27		0.92	0.08				0.79	0.79	0.91
Uniform Delay, d1		6.6	0.0		35.1	0.0				34.9	34.9	15.2
Progression Factor		2.18	1.00		0.61	1.00				1.00	1.00	1.00
Incremental Delay, d2		0.6	0.4		15.5	0.1				11.1	11.2	10.8
Delay (s)		14.9	0.4		36.8	0.1				45.9	46.1	26.0
Level of Service		B	A		D	A				D	D	C
Approach Delay (s)		11.0			31.6			0.0			32.9	
Approach LOS		B			C			A			C	
Intersection Summary												
HCM 2000 Control Delay			24.9									HCM 2000 Level of Service C
HCM 2000 Volume to Capacity ratio			0.96									
Actuated Cycle Length (s)			95.0							12.0		Sum of lost time (s)
Intersection Capacity Utilization			86.8%									ICU Level of Service E
Analysis Period (min)			15									
c Critical Lane Group												

V/C Ratio calculated using HCM worksheet with correct critical movements and lost time

HCM 6th Signalized Intersection Summary
 11: I-5 NB Ramps & SW Elligsen Road

08/31/2021

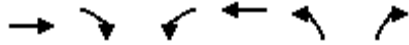

Movement	EBT	EBR	WBL	WBT	NBL	NBR
Lane Configurations	↑↑	↑		↑↑	↑↑	↑
Traffic Volume (veh/h)	734	705	0	322	506	255
Future Volume (veh/h)	734	705	0	322	506	255
Initial Q (Qb), veh	0	0	0	0	0	0
Ped-Bike Adj(A_pbT)		1.00	1.00		1.00	1.00
Parking Bus, Adj	1.00	1.00	1.00	1.00	1.00	1.00
Work Zone On Approach	No			No	No	
Adj Sat Flow, veh/h/ln	1707	1707	0	1796	1811	1811
Adj Flow Rate, veh/h	807	0	0	354	556	0
Peak Hour Factor	0.91	0.91	0.91	0.91	0.91	0.91
Percent Heavy Veh, %	13	13	0	7	6	6
Cap, veh/h	2338		0	2460	652	
Arrive On Green	0.24	0.00	0.00	0.72	0.19	0.00
Sat Flow, veh/h	3329	1447	0	3593	3346	1535
Grp Volume(v), veh/h	807	0	0	354	556	0
Grp Sat Flow(s),veh/h/ln	1622	1447	0	1706	1673	1535
Q Serve(g_s), s	19.6	0.0	0.0	3.1	15.2	0.0
Cycle Q Clear(g_c), s	19.6	0.0	0.0	3.1	15.2	0.0
Prop In Lane		1.00	0.00		1.00	1.00
Lane Grp Cap(c), veh/h	2338		0	2460	652	
V/C Ratio(X)	0.35		0.00	0.14	0.85	
Avail Cap(c_a), veh/h	2338		0	2460	810	
HCM Platoon Ratio	0.33	0.33	1.00	1.00	1.00	1.00
Upstream Filter(l)	0.83	0.00	0.00	1.00	1.00	0.00
Uniform Delay (d), s/veh	17.6	0.0	0.0	4.1	36.9	0.0
Incr Delay (d2), s/veh	0.3	0.0	0.0	0.1	6.6	0.0
Initial Q Delay(d3),s/veh	0.0	0.0	0.0	0.0	0.0	0.0
%ile BackOfQ(50%),veh/ln	8.5	0.0	0.0	0.9	6.7	0.0
Unsig. Movement Delay, s/veh						
LnGrp Delay(d),s/veh	17.9	0.0	0.0	4.3	43.5	0.0
LnGrp LOS	B		A	A	D	
Approach Vol, veh/h	807	A		354	556	A
Approach Delay, s/veh	17.9			4.3	43.5	
Approach LOS	B			A	D	
Timer - Assigned Phs		2			6	8
Phs Duration (G+Y+Rc), s		72.5			72.5	22.5
Change Period (Y+Rc), s		5.0			5.0	4.5
Max Green Setting (Gmax), s		63.0			63.0	22.5
Max Q Clear Time (g_c+11), s		21.6			5.1	17.2
Green Ext Time (p_c), s		9.9			3.8	0.8

Intersection Summary

HCM 6th Ctrl Delay	23.4
HCM 6th LOS	C

Notes

Unsignalized Delay for [NBR, EBR] is excluded from calculations of the approach delay and intersection delay.

Intersection

Int Delay, s/veh 1.8

Movement	EBL	EBT	WBT	WBR	SBL	SBR
Lane Configurations		↕	↕		↕	
Traffic Vol, veh/h	14	101	141	2	18	25
Future Vol, veh/h	14	101	141	2	18	25
Conflicting Peds, #/hr	1	0	0	2	2	1
Sign Control	Free	Free	Free	Free	Stop	Stop
RT Channelized	-	None	-	None	-	None
Storage Length	-	-	-	-	-	-
Veh in Median Storage, #	-	0	0	-	0	-
Grade, %	-	0	0	-	0	-
Peak Hour Factor	80	80	80	80	80	80
Heavy Vehicles, %	0	0	2	2	0	0
Mvmt Flow	18	126	176	3	23	31

Major/Minor	Major1	Major2	Minor2
Conflicting Flow All	181	0	0
Stage 1	-	-	-
Stage 2	-	-	-
Critical Hdwy	4.1	-	-
Critical Hdwy Stg 1	-	-	-
Critical Hdwy Stg 2	-	-	-
Follow-up Hdwy	2.2	-	-
Pot Cap-1 Maneuver	1407	-	-
Stage 1	-	-	-
Stage 2	-	-	-
Platoon blocked, %	-	-	-
Mov Cap-1 Maneuver	1404	-	-
Mov Cap-2 Maneuver	-	-	-
Stage 1	-	-	-
Stage 2	-	-	-

Approach	EB	WB	SB
HCM Control Delay, s	0.9	0	10.1
HCM LOS			B

Minor Lane/Major Mvmt	EBL	EBT	WBT	WBR	SBLn1
Capacity (veh/h)	1404	-	-	-	757
HCM Lane V/C Ratio	0.012	-	-	-	0.071
HCM Control Delay (s)	7.6	0	-	-	10.1
HCM Lane LOS	A	A	-	-	B
HCM 95th %tile Q(veh)	0	-	-	-	0.2

HCM 6th TWSC
 13: SW Norwood Road & SW Vermillion Drive

08/31/2021

Intersection						
Int Delay, s/veh	3.2					
Movement	EBL	EBT	WBT	WBR	SBL	SBR
Lane Configurations		↕	↕		↕	
Traffic Vol, veh/h	20	99	100	6	38	43
Future Vol, veh/h	20	99	100	6	38	43
Conflicting Peds, #/hr	0	0	0	0	0	0
Sign Control	Free	Free	Free	Free	Stop	Stop
RT Channelized	-	None	-	None	-	None
Storage Length	-	-	-	-	-	-
Veh in Median Storage, #	-	0	0	-	0	-
Grade, %	-	0	0	-	0	-
Peak Hour Factor	81	81	81	81	81	81
Heavy Vehicles, %	0	0	3	3	0	0
Mvmt Flow	25	122	123	7	47	53

Major/Minor	Major1	Major2	Minor2		
Conflicting Flow All	130	0	-	0	299
Stage 1	-	-	-	-	127
Stage 2	-	-	-	-	172
Critical Hdwy	4.1	-	-	-	6.4
Critical Hdwy Stg 1	-	-	-	-	5.4
Critical Hdwy Stg 2	-	-	-	-	5.4
Follow-up Hdwy	2.2	-	-	-	3.5
Pot Cap-1 Maneuver	1468	-	-	-	697
Stage 1	-	-	-	-	904
Stage 2	-	-	-	-	863
Platoon blocked, %		-	-	-	
Mov Cap-1 Maneuver	1468	-	-	-	684
Mov Cap-2 Maneuver	-	-	-	-	684
Stage 1	-	-	-	-	888
Stage 2	-	-	-	-	863

Approach	EB	WB	SB
HCM Control Delay, s	1.3	0	10.2
HCM LOS			B

Minor Lane/Major Mvmt	EBL	EBT	WBT	WBR	SBLn1
Capacity (veh/h)	1468	-	-	-	795
HCM Lane V/C Ratio	0.017	-	-	-	0.126
HCM Control Delay (s)	7.5	0	-	-	10.2
HCM Lane LOS	A	A	-	-	B
HCM 95th %tile Q(veh)	0.1	-	-	-	0.4

HCM 6th TWSC
 14: SW 82nd Avenue & SW Norwood Road/Driveway

08/31/2021

Intersection												
Int Delay, s/veh	7.2											
Movement	EBL	EBT	EBR	WBL	WBT	WBR	NBL	NBT	NBR	SBL	SBT	SBR
Lane Configurations		↕			↕			↕			↕	↗
Traffic Vol, veh/h	112	0	24	0	0	0	36	4	0	0	0	70
Future Vol, veh/h	112	0	24	0	0	0	36	4	0	0	0	70
Conflicting Peds, #/hr	0	0	0	0	0	0	0	0	0	0	0	0
Sign Control	Free	Free	Free	Free	Free	Free	Stop	Stop	Stop	Stop	Stop	Stop
RT Channelized	-	-	None	-	-	None	-	-	None	-	-	Free
Storage Length	-	-	-	-	-	-	-	-	-	-	-	15
Veh in Median Storage, #	-	0	-	-	0	-	-	0	-	-	0	-
Grade, %	-	0	-	-	0	-	-	0	-	-	0	-
Peak Hour Factor	89	89	89	89	89	89	89	89	89	89	89	89
Heavy Vehicles, %	2	2	2	0	0	0	6	6	6	10	10	10
Mvmt Flow	126	0	27	0	0	0	40	4	0	0	0	79

Major/Minor	Major1			Major2			Minor1			Minor2		
Conflicting Flow All	1	0	0	27	0	0	267	267	14	269	280	-
Stage 1	-	-	-	-	-	-	266	266	-	1	1	-
Stage 2	-	-	-	-	-	-	1	1	-	268	279	-
Critical Hdwy	4.12	-	-	4.1	-	-	7.16	6.56	6.26	7.2	6.6	-
Critical Hdwy Stg 1	-	-	-	-	-	-	6.16	5.56	-	6.2	5.6	-
Critical Hdwy Stg 2	-	-	-	-	-	-	6.16	5.56	-	6.2	5.6	-
Follow-up Hdwy	2.218	-	-	2.2	-	-	3.554	4.054	3.354	3.59	4.09	-
Pot Cap-1 Maneuver	1622	-	-	1600	-	-	678	632	1054	668	615	0
Stage 1	-	-	-	-	-	-	731	681	-	1002	879	0
Stage 2	-	-	-	-	-	-	1012	887	-	720	665	0
Platoon blocked, %	-	-	-	-	-	-	-	-	-	-	-	-
Mov Cap-1 Maneuver	1622	-	-	1600	-	-	637	582	1054	624	566	-
Mov Cap-2 Maneuver	-	-	-	-	-	-	637	582	-	624	566	-
Stage 1	-	-	-	-	-	-	673	627	-	923	879	-
Stage 2	-	-	-	-	-	-	1012	887	-	658	612	-

Approach	EB	WB	NB	SB
HCM Control Delay, s	6.1	0	11.1	0
HCM LOS			B	A

Minor Lane/Major Mvmt	NBLn1	EBL	EBT	EBR	WBL	WBT	WBR	SBLn1	SBLn2
Capacity (veh/h)	631	1622	-	-	1600	-	-	-	-
HCM Lane V/C Ratio	0.071	0.078	-	-	-	-	-	-	-
HCM Control Delay (s)	11.1	7.4	0	-	0	-	-	0	0
HCM Lane LOS	B	A	A	-	A	-	-	A	A
HCM 95th %tile Q(veh)	0.2	0.3	-	-	0	-	-	-	-

HCM 6th TWSC
 15: SW 65th Avenue & SW Norwood Road

08/31/2021

Intersection						
Int Delay, s/veh	4.7					
Movement	EBL	EBR	NBL	NBT	SBT	SBR
Lane Configurations	T			T		T
Traffic Vol, veh/h	126	48	37	338	235	58
Future Vol, veh/h	126	48	37	338	235	58
Conflicting Peds, #/hr	2	2	2	0	0	2
Sign Control	Stop	Stop	Free	Free	Free	Free
RT Channelized	-	None	-	None	-	None
Storage Length	-	-	-	-	-	-
Veh in Median Storage, #	0	-	-	0	0	-
Grade, %	0	-	-	0	0	-
Peak Hour Factor	90	90	90	90	90	90
Heavy Vehicles, %	2	2	2	2	6	6
Mvmt Flow	140	53	41	376	261	64

Major/Minor	Minor2	Major1	Major2			
Conflicting Flow All	755	297	327	0	-	0
Stage 1	295	-	-	-	-	-
Stage 2	460	-	-	-	-	-
Critical Hdwy	6.42	6.22	4.12	-	-	-
Critical Hdwy Stg 1	5.42	-	-	-	-	-
Critical Hdwy Stg 2	5.42	-	-	-	-	-
Follow-up Hdwy	3.518	3.318	2.218	-	-	-
Pot Cap-1 Maneuver	376	742	1233	-	-	-
Stage 1	755	-	-	-	-	-
Stage 2	636	-	-	-	-	-
Platoon blocked, %				-	-	-
Mov Cap-1 Maneuver	359	739	1231	-	-	-
Mov Cap-2 Maneuver	359	-	-	-	-	-
Stage 1	722	-	-	-	-	-
Stage 2	635	-	-	-	-	-

Approach	EB	NB	SB
HCM Control Delay, s	20.8	0.8	0
HCM LOS	C		

Minor Lane/Major Mvmt	NBL	NBT	EBLn1	SBT	SBR
Capacity (veh/h)	1231	-	418	-	-
HCM Lane V/C Ratio	0.033	-	0.463	-	-
HCM Control Delay (s)	8	0	20.8	-	-
HCM Lane LOS	A	A	C	-	-
HCM 95th %tile Q(veh)	0.1	-	2.4	-	-

HCM 6th Signalized Intersection Summary
 1: SW Boones Ferry Rd & SW Sagert St

08/31/2021



Movement	EBL	EBT	EBR	WBL	WBT	WBR	NBL	NBT	NBR	SBL	SBT	SBR
Lane Configurations												
Traffic Volume (veh/h)	54	166	10	215	94	41	21	369	292	87	638	58
Future Volume (veh/h)	54	166	10	215	94	41	21	369	292	87	638	58
Initial Q (Qb), veh	0	0	0	0	0	0	0	0	0	0	0	0
Ped-Bike Adj(A_pbT)	0.99		0.99	1.00		1.00	1.00		0.98	1.00		0.98
Parking Bus, Adj	1.00	1.00	1.00	1.00	1.00	1.00	1.00	1.00	1.00	1.00	1.00	1.00
Work Zone On Approach		No			No			No			No	
Adj Sat Flow, veh/h/ln	1885	1885	1885	1900	1900	1900	1885	1885	1885	1885	1885	1885
Adj Flow Rate, veh/h	59	182	11	236	103	29	23	405	294	96	701	31
Peak Hour Factor	0.91	0.91	0.91	0.91	0.91	0.91	0.91	0.91	0.91	0.91	0.91	0.91
Percent Heavy Veh, %	1	1	1	0	0	0	1	1	1	1	1	1
Cap, veh/h	346	238	14	363	306	86	302	489	355	291	971	804
Arrive On Green	0.05	0.14	0.13	0.13	0.22	0.21	0.03	0.49	0.48	0.06	0.52	0.52
Sat Flow, veh/h	1795	1759	106	1810	1424	401	1795	1004	729	1795	1885	1560
Grp Volume(v), veh/h	59	0	193	236	0	132	23	0	699	96	701	31
Grp Sat Flow(s),veh/h/ln	1795	0	1865	1810	0	1826	1795	0	1733	1795	1885	1560
Q Serve(g_s), s	2.3	0.0	8.4	9.0	0.0	5.2	0.5	0.0	29.4	2.2	24.3	0.8
Cycle Q Clear(g_c), s	2.3	0.0	8.4	9.0	0.0	5.2	0.5	0.0	29.4	2.2	24.3	0.8
Prop In Lane	1.00		0.06	1.00		0.22	1.00		0.42	1.00		1.00
Lane Grp Cap(c), veh/h	346	0	252	363	0	393	302	0	844	291	971	804
V/C Ratio(X)	0.17	0.00	0.76	0.65	0.00	0.34	0.08	0.00	0.83	0.33	0.72	0.04
Avail Cap(c_a), veh/h	489	0	353	363	0	393	481	0	1147	419	1247	1032
HCM Platoon Ratio	1.00	1.00	1.00	1.00	1.00	1.00	1.00	1.00	1.00	1.00	1.00	1.00
Upstream Filter(I)	1.00	0.00	1.00	1.00	0.00	1.00	1.00	0.00	1.00	1.00	1.00	1.00
Uniform Delay (d), s/veh	29.0	0.0	35.3	25.4	0.0	28.2	13.2	0.0	18.9	15.3	15.8	10.2
Incr Delay (d2), s/veh	0.1	0.0	3.8	3.2	0.0	0.2	0.0	0.0	4.9	0.2	2.1	0.0
Initial Q Delay(d3),s/veh	0.0	0.0	0.0	0.0	0.0	0.0	0.0	0.0	0.0	0.0	0.0	0.0
%ile BackOfQ(50%),veh/ln	1.0	0.0	4.0	4.1	0.0	2.2	0.2	0.0	12.0	0.8	10.1	0.3
Unsig. Movement Delay, s/veh												
LnGrp Delay(d),s/veh	29.1	0.0	39.1	28.6	0.0	28.3	13.2	0.0	23.8	15.5	18.0	10.2
LnGrp LOS	C	A	D	C	A	C	B	A	C	B	B	B
Approach Vol, veh/h		252			368			722			828	
Approach Delay, s/veh		36.7			28.5			23.5			17.4	
Approach LOS		D			C			C			B	
Timer - Assigned Phs	1	2	3	4	5	6	7	8				
Phs Duration (G+Y+Rc), s	9.0	45.2	15.0	15.5	6.6	47.6	8.3	22.2				
Change Period (Y+Rc), s	4.5	5.0	4.5	4.5	4.5	5.0	4.5	4.5				
Max Green Setting (Gmax), s	10.5	55.0	10.5	15.5	10.5	55.0	10.5	15.5				
Max Q Clear Time (g_c+I1), s	4.2	31.4	11.0	10.4	2.5	26.3	4.3	7.2				
Green Ext Time (p_c), s	0.1	8.8	0.0	0.3	0.0	9.5	0.0	0.2				

Intersection Summary

HCM 6th Ctrl Delay	23.5
HCM 6th LOS	C

Notes

User approved pedestrian interval to be less than phase max green.

HCM 6th Signalized Intersection Summary
 2: SW Boones Ferry Rd & SW Avery St

08/31/2021



Movement	EBL	EBT	EBR	WBL	WBT	WBR	NBL	NBT	NBR	SBL	SBT	SBR
Lane Configurations												
Traffic Volume (veh/h)	248	126	263	51	43	8	112	425	42	14	747	102
Future Volume (veh/h)	248	126	263	51	43	8	112	425	42	14	747	102
Initial Q (Qb), veh	0	0	0	0	0	0	0	0	0	0	0	0
Ped-Bike Adj(A_pbT)	0.99		0.97	0.99		0.99	1.00		0.98	1.00		0.98
Parking Bus, Adj	1.00	1.00	1.00	1.00	1.00	1.00	1.00	1.00	1.00	1.00	1.00	1.00
Work Zone On Approach		No		No		No		No		No		No
Adj Sat Flow, veh/h/ln	1841	1841	1841	1870	1870	1870	1811	1811	1811	1870	1870	1870
Adj Flow Rate, veh/h	258	131	201	53	45	3	117	443	39	15	778	96
Peak Hour Factor	0.96	0.96	0.96	0.96	0.96	0.96	0.96	0.96	0.96	0.96	0.96	0.96
Percent Heavy Veh, %	4	4	4	2	2	2	6	6	6	2	2	2
Cap, veh/h	438	147	225	156	210	14	210	929	82	456	873	108
Arrive On Green	0.14	0.23	0.22	0.04	0.12	0.11	0.05	0.57	0.55	0.02	0.54	0.54
Sat Flow, veh/h	1753	641	984	1781	1732	115	1725	1637	144	1781	1627	201
Grp Volume(v), veh/h	258	0	332	53	0	48	117	0	482	15	0	874
Grp Sat Flow(s),veh/h/ln	1753	0	1626	1781	0	1848	1725	0	1781	1781	0	1828
Q Serve(g_s), s	13.4	0.0	21.2	2.8	0.0	2.5	3.2	0.0	17.2	0.4	0.0	45.3
Cycle Q Clear(g_c), s	13.4	0.0	21.2	2.8	0.0	2.5	3.2	0.0	17.2	0.4	0.0	45.3
Prop In Lane	1.00		0.61	1.00		0.06	1.00		0.08	1.00		0.11
Lane Grp Cap(c), veh/h	438	0	372	156	0	224	210	0	1011	456	0	981
V/C Ratio(X)	0.59	0.00	0.89	0.34	0.00	0.21	0.56	0.00	0.48	0.03	0.00	0.89
Avail Cap(c_a), veh/h	529	0	396	190	0	224	225	0	1101	526	0	1130
HCM Platoon Ratio	1.00	1.00	1.00	1.00	1.00	1.00	1.00	1.00	1.00	1.00	1.00	1.00
Upstream Filter(I)	1.00	0.00	1.00	1.00	0.00	1.00	1.00	0.00	1.00	1.00	0.00	1.00
Uniform Delay (d), s/veh	33.0	0.0	40.2	40.3	0.0	42.4	22.6	0.0	13.7	12.3	0.0	22.0
Incr Delay (d2), s/veh	0.5	0.0	20.0	0.5	0.0	0.2	1.3	0.0	0.5	0.0	0.0	8.7
Initial Q Delay(d3),s/veh	0.0	0.0	0.0	0.0	0.0	0.0	0.0	0.0	0.0	0.0	0.0	0.0
%ile BackOfQ(50%),veh/ln	5.7	0.0	10.5	1.2	0.0	1.2	1.5	0.0	6.7	0.2	0.0	20.6
Unsig. Movement Delay, s/veh												
LnGrp Delay(d),s/veh	33.5	0.0	60.2	40.8	0.0	42.6	23.8	0.0	14.2	12.4	0.0	30.7
LnGrp LOS	C	A	E	D	A	D	C	A	B	B	A	C
Approach Vol, veh/h		590			101			599			889	
Approach Delay, s/veh		48.5			41.6			16.1			30.4	
Approach LOS		D			D			B			C	
Timer - Assigned Phs	1	2	3	4	5	6	7	8				
Phs Duration (G+Y+Rc), s	5.8	64.6	8.0	28.4	9.1	61.3	19.5	16.9				
Change Period (Y+Rc), s	4.0	5.5	4.0	5.0	4.0	5.5	4.0	5.0				
Max Green Setting (Gmax), s	6.0	64.5	6.0	25.0	6.0	64.5	21.0	10.0				
Max Q Clear Time (g_c+1/2), s	12.4	19.2	4.8	23.2	5.2	47.3	15.4	4.5				
Green Ext Time (p_c), s	0.0	5.3	0.0	0.3	0.0	8.5	0.1	0.0				

Intersection Summary

HCM 6th Ctrl Delay	31.9
HCM 6th LOS	C

Notes

User approved pedestrian interval to be less than phase max green.

HCM 6th Signalized Intersection Summary
 3: SW Boones Ferry Road & SW Ibach Street/SW Ibach Court

08/31/2021



Movement	EBL	EBT	EBR	WBL	WBT	WBR	NBL	NBT	NBR	SBL	SBT	SBR
Lane Configurations												
Traffic Volume (veh/h)	159	0	159	3	1	5	194	416	2	12	770	280
Future Volume (veh/h)	159	0	159	3	1	5	194	416	2	12	770	280
Initial Q (Qb), veh	0	0	0	0	0	0	0	0	0	0	0	0
Ped-Bike Adj(A_pbT)	0.95		0.98	0.98		0.95	1.00		0.99	1.00		0.99
Parking Bus, Adj	1.00	1.00	1.00	1.00	1.00	1.00	1.00	1.00	1.00	1.00	1.00	1.00
Work Zone On Approach		No			No			No			No	
Adj Sat Flow, veh/h/ln	1885	1885	1885	1900	1900	1900	1841	1841	1841	1870	1870	1870
Adj Flow Rate, veh/h	166	0	62	3	1	5	202	433	2	12	802	235
Peak Hour Factor	0.96	0.96	0.96	0.96	0.96	0.96	0.96	0.96	0.96	0.96	0.96	0.96
Percent Heavy Veh, %	1	1	1	0	0	0	4	4	4	2	2	2
Cap, veh/h	315	0	256	119	55	140	239	1192	6	21	984	828
Arrive On Green	0.16	0.00	0.16	0.16	0.16	0.16	0.14	0.65	0.65	0.01	0.53	0.53
Sat Flow, veh/h	1349	0	1559	352	333	856	1753	1831	8	1781	1870	1573
Grp Volume(v), veh/h	166	0	62	9	0	0	202	0	435	12	802	235
Grp Sat Flow(s),veh/h/ln	1349	0	1559	1541	0	0	1753	0	1839	1781	1870	1573
Q Serve(g_s), s	8.7	0.0	2.7	0.0	0.0	0.0	8.8	0.0	8.4	0.5	27.7	6.5
Cycle Q Clear(g_c), s	9.0	0.0	2.7	0.4	0.0	0.0	8.8	0.0	8.4	0.5	27.7	6.5
Prop In Lane	1.00		1.00	0.33		0.56	1.00		0.00	1.00		1.00
Lane Grp Cap(c), veh/h	315	0	256	314	0	0	239	0	1197	21	984	828
V/C Ratio(X)	0.53	0.00	0.24	0.03	0.00	0.00	0.84	0.00	0.36	0.57	0.81	0.28
Avail Cap(c_a), veh/h	535	0	510	557	0	0	247	0	1297	251	1319	1109
HCM Platoon Ratio	1.00	1.00	1.00	1.00	1.00	1.00	1.00	1.00	1.00	1.00	1.00	1.00
Upstream Filter(I)	1.00	0.00	1.00	1.00	0.00	0.00	1.00	0.00	1.00	1.00	1.00	1.00
Uniform Delay (d), s/veh	31.0	0.0	28.4	27.4	0.0	0.0	32.9	0.0	6.2	38.3	15.3	10.3
Incr Delay (d2), s/veh	0.8	0.0	0.3	0.0	0.0	0.0	21.3	0.0	0.3	14.2	3.7	0.3
Initial Q Delay(d3),s/veh	0.0	0.0	0.0	0.0	0.0	0.0	0.0	0.0	0.0	0.0	0.0	0.0
%ile BackOfQ(50%),veh/ln	2.9	0.0	1.0	0.1	0.0	0.0	5.0	0.0	2.6	0.3	11.1	2.0
Unsig. Movement Delay, s/veh												
LnGrp Delay(d),s/veh	31.8	0.0	28.7	27.4	0.0	0.0	54.2	0.0	6.5	52.6	19.0	10.6
LnGrp LOS	C	A	C	C	A	A	D	A	A	D	B	B
Approach Vol, veh/h		228			9			637			1049	
Approach Delay, s/veh		31.0			27.4			21.6			17.5	
Approach LOS		C			C			C			B	
Timer - Assigned Phs	1	2		4	5	6		8				
Phs Duration (G+Y+Rc), s	4.9	55.8		17.3	14.6	46.0		17.3				
Change Period (Y+Rc), s	4.0	5.0		4.5	4.0	5.0		4.5				
Max Green Setting (Gmax), s	1.0	55.0		25.5	11.0	55.0		25.5				
Max Q Clear Time (g_c+1/2), s	12.5	10.4		11.0	10.8	29.7		2.4				
Green Ext Time (p_c), s	0.0	4.9		0.5	0.0	11.3		0.0				
Intersection Summary												
HCM 6th Ctrl Delay											20.5	
HCM 6th LOS											C	

HCM 6th TWSC
4: SW Boones Ferry Road & SW Iowa Drive

08/31/2021

Intersection												
Int Delay, s/veh	4.7											
Movement	EBL	EBT	EBR	WBL	WBT	WBR	NBL	NBT	NBR	SBL	SBT	SBR
Lane Configurations		↕			↕		↕	↕		↕	↕	
Traffic Vol, veh/h	36	0	34	13	1	37	33	510	29	35	762	49
Future Vol, veh/h	36	0	34	13	1	37	33	510	29	35	762	49
Conflicting Peds, #/hr	0	0	4	4	0	0	4	0	4	0	0	0
Sign Control	Stop	Stop	Stop	Stop	Stop	Stop	Free	Free	Free	Free	Free	Free
RT Channelized	-	-	None	-	-	None	-	-	None	-	-	None
Storage Length	-	-	-	-	-	-	95	-	-	105	-	-
Veh in Median Storage, #	-	0	-	-	0	-	-	0	-	-	0	-
Grade, %	-	0	-	-	0	-	-	0	-	-	0	-
Peak Hour Factor	94	94	94	94	94	94	94	94	94	94	94	94
Heavy Vehicles, %	5	5	5	2	2	2	3	3	3	1	1	1
Mvmt Flow	38	0	36	14	1	39	35	543	31	37	811	52

Major/Minor	Minor2		Minor1		Major1			Major2				
Conflicting Flow All	1564	1563	845	1566	1574	563	867	0	0	578	0	0
Stage 1	915	915	-	633	633	-	-	-	-	-	-	-
Stage 2	649	648	-	933	941	-	-	-	-	-	-	-
Critical Hdwy	7.15	6.55	6.25	7.12	6.52	6.22	4.13	-	-	4.11	-	-
Critical Hdwy Stg 1	6.15	5.55	-	6.12	5.52	-	-	-	-	-	-	-
Critical Hdwy Stg 2	6.15	5.55	-	6.12	5.52	-	-	-	-	-	-	-
Follow-up Hdwy	3.545	4.045	3.345	3.518	4.018	3.318	2.227	-	-	2.209	-	-
Pot Cap-1 Maneuver	89	110	358	90	110	526	772	-	-	1001	-	-
Stage 1	323	348	-	468	473	-	-	-	-	-	-	-
Stage 2	454	461	-	319	342	-	-	-	-	-	-	-
Platoon blocked, %								-	-	-	-	-
Mov Cap-1 Maneuver	76	100	355	75	100	524	769	-	-	997	-	-
Mov Cap-2 Maneuver	76	100	-	75	100	-	-	-	-	-	-	-
Stage 1	307	334	-	445	449	-	-	-	-	-	-	-
Stage 2	400	438	-	275	328	-	-	-	-	-	-	-

Approach	EB		WB		NB			SB		
HCM Control Delay, s	71.4		29.4		0.6			0.4		
HCM LOS	F		D							

Minor Lane/Major Mvmt	NBL	NBT	NBR	EBLn1WBLn1	SBL	SBT	SBR
Capacity (veh/h)	769	-	-	123	201	997	-
HCM Lane V/C Ratio	0.046	-	-	0.605	0.27	0.037	-
HCM Control Delay (s)	9.9	-	-	71.4	29.4	8.8	-
HCM Lane LOS	A	-	-	F	D	A	-
HCM 95th %tile Q(veh)	0.1	-	-	3.1	1	0.1	-

HCM 6th TWSC
5: SW Boones Ferry Road & SW Norwood Road

08/31/2021

Intersection						
Int Delay, s/veh	1.9					
Movement	WBL	WBR	NBT	NBR	SBL	SBT
Lane Configurations	Y		↑	↑	↑	↑
Traffic Vol, veh/h	39	76	495	95	89	720
Future Vol, veh/h	39	76	495	95	89	720
Conflicting Peds, #/hr	2	2	0	2	2	0
Sign Control	Stop	Stop	Free	Free	Free	Free
RT Channelized	-	None	-	None	-	None
Storage Length	-	-	-	65	290	-
Veh in Median Storage, #	0	-	0	-	-	0
Grade, %	0	-	0	-	-	0
Peak Hour Factor	95	95	95	95	95	95
Heavy Vehicles, %	2	2	3	3	2	2
Mvmt Flow	41	80	521	100	94	758

Major/Minor	Minor1	Major1	Major2			
Conflicting Flow All	1471	525	0	0	623	0
Stage 1	523	-	-	-	-	-
Stage 2	948	-	-	-	-	-
Critical Hdwy	6.42	6.22	-	-	4.12	-
Critical Hdwy Stg 1	5.42	-	-	-	-	-
Critical Hdwy Stg 2	5.42	-	-	-	-	-
Follow-up Hdwy	3.518	3.318	-	-	2.218	-
Pot Cap-1 Maneuver	140	552	-	-	958	-
Stage 1	595	-	-	-	-	-
Stage 2	377	-	-	-	-	-
Platoon blocked, %			-	-		
Mov Cap-1 Maneuver	126	550	-	-	956	-
Mov Cap-2 Maneuver	249	-	-	-	-	-
Stage 1	594	-	-	-	-	-
Stage 2	339	-	-	-	-	-

Approach	WB	NB	SB
HCM Control Delay, s	18.3	0	1
HCM LOS	C		

Minor Lane/Major Mvmt	NBT	NBRWBLn1	SBL	SBT
Capacity (veh/h)	-	-	390	956
HCM Lane V/C Ratio	-	-	0.31	0.098
HCM Control Delay (s)	-	-	18.3	9.2
HCM Lane LOS	-	-	C	A
HCM 95th %tile Q(veh)	-	-	1.3	0.3

Intersection						
Int Delay, s/veh	0					
Movement	WBL	WBR	NBT	NBR	SBL	SBT
Lane Configurations						
Traffic Vol, veh/h	0	0	585	2	1	772
Future Vol, veh/h	0	0	585	2	1	772
Conflicting Peds, #/hr	2	2	0	2	2	0
Sign Control	Stop	Stop	Free	Free	Free	Free
RT Channelized	-	None	-	None	-	None
Storage Length	-	-	-	-	150	-
Veh in Median Storage, #	2	-	0	-	-	0
Grade, %	0	-	0	-	-	0
Peak Hour Factor	95	95	95	95	95	95
Heavy Vehicles, %	0	0	3	3	2	2
Mvmt Flow	0	0	616	2	1	813

Major/Minor	Minor1	Major1	Major2		
Conflicting Flow All	1436	621	0	0	620
Stage 1	619	-	-	-	-
Stage 2	817	-	-	-	-
Critical Hdwy	6.4	6.2	-	-	4.12
Critical Hdwy Stg 1	5.4	-	-	-	-
Critical Hdwy Stg 2	5.4	-	-	-	-
Follow-up Hdwy	3.5	3.3	-	-	2.218
Pot Cap-1 Maneuver	149	491	-	-	960
Stage 1	541	-	-	-	-
Stage 2	438	-	-	-	-
Platoon blocked, %			-	-	-
Mov Cap-1 Maneuver	148	489	-	-	958
Mov Cap-2 Maneuver	349	-	-	-	-
Stage 1	540	-	-	-	-
Stage 2	437	-	-	-	-

Approach	WB	NB	SB
HCM Control Delay, s	0	0	0
HCM LOS	A		

Minor Lane/Major Mvmt	NBT	NBRWBLn1	SBL	SBT
Capacity (veh/h)	-	-	958	-
HCM Lane V/C Ratio	-	-	0.001	-
HCM Control Delay (s)	-	-	0	8.8
HCM Lane LOS	-	-	A	A
HCM 95th %tile Q(veh)	-	-	-	0

HCM 6th Signalized Intersection Summary
 8: SW Boones Ferry Road & SW Day Road

08/31/2021



Movement	EBL	EBT	EBR	WBL	WBT	WBR	NBL	NBT	NBR	SBL	SBT	SBR
Lane Configurations		↖	↗		↔		↖	↗		↖	↗	
Traffic Volume (veh/h)	3	0	781	0	0	0	640	582	0	0	704	68
Future Volume (veh/h)	3	0	781	0	0	0	640	582	0	0	704	68
Initial Q (Qb), veh	0	0	0	0	0	0	0	0	0	0	0	0
Ped-Bike Adj(A_pbT)	1.00		1.00	1.00		1.00	1.00		1.00	1.00		1.00
Parking Bus, Adj	1.00	1.00	1.00	1.00	1.00	1.00	1.00	1.00	1.00	1.00	1.00	1.00
Work Zone On Approach		No			No			No			No	
Adj Sat Flow, veh/h/ln	1870	1870	1870	1900	1900	1900	1856	1856	1856	1885	1885	1885
Adj Flow Rate, veh/h	3	0	695	0	0	0	653	594	0	0	718	64
Peak Hour Factor	0.98	0.98	0.98	0.98	0.98	0.98	0.98	0.98	0.98	0.98	0.98	0.98
Percent Heavy Veh, %	2	2	2	0	0	0	3	3	3	1	1	1
Cap, veh/h	271	0	652	0	271	0	734	683	0	640	1607	143
Arrive On Green	0.14	0.00	0.15	0.00	0.00	0.00	0.43	0.61	0.00	0.00	0.48	0.47
Sat Flow, veh/h	1417	0	1585	0	1900	0	2827	1856	0	1795	3326	296
Grp Volume(v), veh/h	3	0	695	0	0	0	653	594	0	0	386	396
Grp Sat Flow(s),veh/h/ln	1418	0	1585	0	1900	0	1414	1856	0	1795	1791	1832
Q Serve(g_s), s	0.2	0.0	15.9	0.0	0.0	0.0	22.4	27.8	0.0	0.0	14.9	15.0
Cycle Q Clear(g_c), s	0.2	0.0	15.9	0.0	0.0	0.0	22.4	27.8	0.0	0.0	14.9	15.0
Prop In Lane	1.00		1.00	0.00		0.00	1.00		0.00	1.00		0.16
Lane Grp Cap(c), veh/h	264	0	652	0	271	0	734	683	0	640	865	885
V/C Ratio(X)	0.01	0.00	1.07	0.00	0.00	0.00	0.89	0.87	0.00	0.00	0.45	0.45
Avail Cap(c_a), veh/h	264	0	652	0	271	0	1158	1219	0	640	865	885
HCM Platoon Ratio	1.00	1.00	1.00	1.00	1.00	1.00	1.67	1.67	1.67	1.00	1.00	1.00
Upstream Filter(I)	1.00	0.00	1.00	0.00	0.00	0.00	0.92	0.92	0.00	0.00	1.00	1.00
Uniform Delay (d), s/veh	38.9	0.0	30.9	0.0	0.0	0.0	28.3	18.1	0.0	0.0	17.9	18.0
Incr Delay (d2), s/veh	0.0	0.0	54.3	0.0	0.0	0.0	4.1	13.2	0.0	0.0	1.7	1.6
Initial Q Delay(d3),s/veh	0.0	0.0	0.0	0.0	0.0	0.0	0.0	0.0	0.0	0.0	0.0	0.0
%ile BackOfQ(50%),veh/ln	0.1	0.0	25.1	0.0	0.0	0.0	6.4	10.2	0.0	0.0	6.1	6.2
Unsig. Movement Delay, s/veh												
LnGrp Delay(d),s/veh	38.9	0.0	85.2	0.0	0.0	0.0	32.4	31.4	0.0	0.0	19.6	19.6
LnGrp LOS	D	A	F	A	A	A	C	C	A	A	B	B
Approach Vol, veh/h		698			0			1247			782	
Approach Delay, s/veh		85.0			0.0			31.9			19.6	
Approach LOS		F						C			B	
Timer - Assigned Phs	1	2		4	5	6		8				
Phs Duration (G+Y+Rc), s	31.3	54.7		19.0	43.4	42.6		19.0				
Change Period (Y+Rc), s	* 5.4	* 5.4		4.5	* 5.4	* 5.4		4.5				
Max Green Setting (Gmax), s	* 42	* 34		14.5	* 8.5	* 68		14.5				
Max Q Clear Time (g_c+I1), s	24.4	17.0		0.0	0.0	29.8		17.9				
Green Ext Time (p_c), s	1.5	6.3		0.0	0.0	7.4		0.0				

Intersection Summary

HCM 6th Ctrl Delay	42.0
HCM 6th LOS	D

Notes

- User approved pedestrian interval to be less than phase max green.
- * HCM 6th computational engine requires equal clearance times for the phases crossing the barrier.

HCM 6th Signalized Intersection Summary
 9: SW Boones Ferry Road & SW 95th Avenue

08/31/2021



Movement	EBL	EBT	EBR	WBL	WBT	WBR	NBL	NBT	NBR	SBL	SBT	SBR
Lane Configurations		↕	↗	↘	↖	↗	↖	↕	↖	↗	↖	↗
Traffic Volume (veh/h)	232	1	803	48	17	6	583	890	12	3	1141	236
Future Volume (veh/h)	232	1	803	48	17	6	583	890	12	3	1141	236
Initial Q (Qb), veh	0	0	0	0	0	0	0	0	0	0	0	0
Ped-Bike Adj(A_pbT)	0.99		0.97	1.00		0.99	1.00		1.00	1.00		1.00
Parking Bus, Adj	1.00	1.00	1.00	1.00	1.00	1.00	1.00	1.00	1.00	1.00	1.00	1.00
Work Zone On Approach		No			No			No			No	
Adj Sat Flow, veh/h/ln	1826	1826	1826	1870	1870	1870	1781	1781	1781	1856	1856	1856
Adj Flow Rate, veh/h	242	1	836	50	18	6	607	927	12	3	1189	0
Peak Hour Factor	0.96	0.96	0.96	0.96	0.96	0.96	0.96	0.96	0.96	0.96	0.96	0.96
Percent Heavy Veh, %	5	5	5	2	2	2	8	8	8	3	3	3
Cap, veh/h	283	1	1035	75	230	77	705	1196	15	645	1763	
Arrive On Green	0.16	0.17	0.17	0.17	0.17	0.17	0.43	0.70	0.68	0.73	1.00	0.00
Sat Flow, veh/h	1249	5	2634	656	1340	447	3291	3421	44	1767	3526	1572
Grp Volume(v), veh/h	243	0	836	50	0	24	607	459	480	3	1189	0
Grp Sat Flow(s),veh/h/ln	1255	0	1317	656	0	1787	1646	1692	1773	1767	1763	1572
Q Serve(g_s), s	15.8	0.0	18.0	1.0	0.0	1.2	17.5	18.7	18.7	0.0	0.0	0.0
Cycle Q Clear(g_c), s	17.0	0.0	18.0	18.0	0.0	1.2	17.5	18.7	18.7	0.0	0.0	0.0
Prop In Lane	1.00		1.00	1.00		0.25	1.00		0.02	1.00		1.00
Lane Grp Cap(c), veh/h	272	0	1035	75	0	306	705	591	620	645	1763	
V/C Ratio(X)	0.89	0.00	0.81	0.67	0.00	0.08	0.86	0.78	0.78	0.00	0.67	
Avail Cap(c_a), veh/h	272	0	1035	75	0	306	1066	1048	1098	645	1763	
HCM Platoon Ratio	1.00	1.00	1.00	1.00	1.00	1.00	2.00	2.00	2.00	2.00	2.00	2.00
Upstream Filter(I)	1.00	0.00	1.00	1.00	0.00	1.00	0.61	0.61	0.61	0.58	0.58	0.00
Uniform Delay (d), s/veh	45.5	0.0	29.0	52.4	0.0	36.5	28.6	13.1	13.1	9.0	0.0	0.0
Incr Delay (d2), s/veh	28.8	0.0	4.7	19.0	0.0	0.1	3.0	6.0	5.8	0.0	1.2	0.0
Initial Q Delay(d3),s/veh	0.0	0.0	0.0	0.0	0.0	0.0	0.0	0.0	0.0	0.0	0.0	0.0
%ile BackOfQ(50%),veh/ln	8.6	0.0	9.8	1.7	0.0	0.5	5.3	4.8	5.0	0.0	0.3	0.0
Unsig. Movement Delay, s/veh												
LnGrp Delay(d),s/veh	74.3	0.0	33.6	71.5	0.0	36.6	31.6	19.1	18.9	9.0	1.2	0.0
LnGrp LOS	E	A	C	E	A	D	C	B	B	A	A	
Approach Vol, veh/h		1079			74			1546			1192	A
Approach Delay, s/veh		42.8			60.2			23.9			1.2	
Approach LOS		D			E			C			A	
Timer - Assigned Phs	1	2		4	5	6		8				
Phs Duration (G+Y+Rc), s	36.5	56.5		22.0	42.3	40.7		22.0				
Change Period (Y+Rc), s	5.0	5.0		5.0	5.0	5.0		5.0				
Max Green Setting (Gmax), s	33.0	40.0		17.0	9.0	64.0		17.0				
Max Q Clear Time (g_c+1), s	19.5	2.0		20.0	2.0	20.7		20.0				
Green Ext Time (p_c), s	2.0	11.0		0.0	0.0	15.0		0.0				

Intersection Summary

HCM 6th Ctrl Delay	22.9
HCM 6th LOS	C

Notes

- User approved pedestrian interval to be less than phase max green.
- Unsignalized Delay for [SBR] is excluded from calculations of the approach delay and intersection delay.

HCM Signalized Intersection Capacity Analysis
 10: I-5 SB Ramps & SW Boones Ferry Road/SW Elligsen Road

08/31/2021



Movement	EBL	EBT	EBR	WBL	WBT	WBR	NBL	NBT	NBR	SBL	SBT	SBR	
Lane Configurations		↑↑	↗		↑↑	↗				↘	↖	↗	
Traffic Volume (vph)	0	1088	904	0	682	375	0	0	0	576	88	802	
Future Volume (vph)	0	1088	904	0	682	375	0	0	0	576	88	802	
Ideal Flow (vphpl)	1900	1900	1900	1900	1900	1900	1900	1900	1900	1900	1900	1900	
Lane Width	12	12	12	12	12	12	12	12	12	12	12	16	
Total Lost time (s)		4.0	4.0		4.0	3.0				4.0	4.0	4.0	
Lane Util. Factor		0.95	1.00		0.95	1.00				0.95	0.95	1.00	
Fr _t		1.00	0.85		1.00	0.85				1.00	1.00	0.85	
Fl _t Protected		1.00	1.00		1.00	1.00				0.95	0.96	1.00	
Satd. Flow (prot)		3505	1568		3505	1568				1603	1627	1711	
Fl _t Permitted		1.00	1.00		1.00	1.00				0.95	0.96	1.00	
Satd. Flow (perm)		3505	1568		3505	1568				1603	1627	1711	
Peak-hour factor, PHF	0.97	0.97	0.97	0.97	0.97	0.97	0.97	0.97	0.97	0.97	0.97	0.97	
Adj. Flow (vph)	0	1122	932	0	703	387	0	0	0	594	91	827	
RTOR Reduction (vph)	0	0	0	0	0	0	0	0	0	0	0	66	
Lane Group Flow (vph)	0	1122	932	0	703	387	0	0	0	339	346	761	
Heavy Vehicles (%)	3%	3%	3%	3%	3%	3%	0%	0%	0%	7%	7%	7%	
Turn Type		NA	Free		NA	Free				Split	NA	custom	
Protected Phases		2			6					4	4	5	
Permitted Phases			Free		6	Free						4	
Actuated Green, G (s)		68.3	105.0		48.1	105.0				27.2	27.2	42.9	
Effective Green, g (s)		69.3	105.0		49.1	105.0				27.7	27.7	43.9	
Actuated g/C Ratio		0.66	1.00		0.47	1.00				0.26	0.26	0.42	
Clearance Time (s)		5.0			5.0					4.5	4.5	4.5	
Vehicle Extension (s)		4.1			4.1					2.3	2.3	2.3	
Lane Grp Cap (vph)		2313	1568		1639	1568				422	429	780	
v/s Ratio Prot		0.32			0.20					0.21	0.21	c0.15	
v/s Ratio Perm			c0.59			0.25						0.29	
v/c Ratio		0.49	0.59		0.43	0.25				0.80	0.81	0.98	
Uniform Delay, d ₁		8.9	0.0		18.6	0.0				36.1	36.1	30.0	
Progression Factor		0.95	1.00		1.07	1.00				1.00	1.00	1.00	
Incremental Delay, d ₂		0.5	1.2		0.8	0.4				10.2	10.2	26.1	
Delay (s)		9.0	1.2		20.7	0.4				46.3	46.4	56.1	
Level of Service		A	A		C	A				D	D	E	
Approach Delay (s)		5.5			13.5			0.0			51.7		
Approach LOS		A			B			A			D		
Intersection Summary													
HCM 2000 Control Delay			22.3		HCM 2000 Level of Service						C		
HCM 2000 Volume to Capacity ratio			0.84										
Actuated Cycle Length (s)			105.0		Sum of lost time (s)					12.0			
Intersection Capacity Utilization			75.2%		ICU Level of Service					D			
Analysis Period (min)			15										

c Critical Lane Group

V/C Ratio calculated using HCM worksheet with correct critical movements and lost time

HCM 6th Signalized Intersection Summary

11: I-5 NB Ramps & SW Elligsen Road

08/31/2021

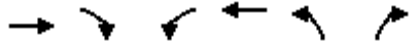

Movement	EBT	EBR	WBL	WBT	NBL	NBR
Lane Configurations	↑↑	↑		↑↑	↑↑	↑
Traffic Volume (veh/h)	974	692	0	744	314	236
Future Volume (veh/h)	974	692	0	744	314	236
Initial Q (Qb), veh	0	0	0	0	0	0
Ped-Bike Adj(A_pbT)		1.00	1.00		1.00	1.00
Parking Bus, Adj	1.00	1.00	1.00	1.00	1.00	1.00
Work Zone On Approach	No			No	No	
Adj Sat Flow, veh/h/ln	1841	1841	0	1885	1841	1841
Adj Flow Rate, veh/h	1070	0	0	818	345	0
Peak Hour Factor	0.91	0.91	0.91	0.91	0.91	0.91
Percent Heavy Veh, %	4	4	0	1	4	4
Cap, veh/h	2778		0	2845	441	
Arrive On Green	1.00	0.00	0.00	0.79	0.13	0.00
Sat Flow, veh/h	3589	1560	0	3770	3401	1560
Grp Volume(v), veh/h	1070	0	0	818	345	0
Grp Sat Flow(s),veh/h/ln	1749	1560	0	1791	1700	1560
Q Serve(g_s), s	0.0	0.0	0.0	6.4	10.3	0.0
Cycle Q Clear(g_c), s	0.0	0.0	0.0	6.4	10.3	0.0
Prop In Lane		1.00	0.00		1.00	1.00
Lane Grp Cap(c), veh/h	2778		0	2845	441	
V/C Ratio(X)	0.39		0.00	0.29	0.78	
Avail Cap(c_a), veh/h	2778		0	2845	1166	
HCM Platoon Ratio	2.00	2.00	1.00	1.00	1.00	1.00
Upstream Filter(l)	0.81	0.00	0.00	1.00	1.00	0.00
Uniform Delay (d), s/veh	0.0	0.0	0.0	2.9	44.3	0.0
Incr Delay (d2), s/veh	0.3	0.0	0.0	0.3	1.9	0.0
Initial Q Delay(d3),s/veh	0.0	0.0	0.0	0.0	0.0	0.0
%ile BackOfQ(50%),veh/ln	0.1	0.0	0.0	1.6	4.4	0.0
Unsig. Movement Delay, s/veh						
LnGrp Delay(d),s/veh	0.3	0.0	0.0	3.1	46.2	0.0
LnGrp LOS	A		A	A	D	
Approach Vol, veh/h	1070	A		818	345	A
Approach Delay, s/veh	0.3			3.1	46.2	
Approach LOS	A			A	D	
Timer - Assigned Phs		2			6	8
Phs Duration (G+Y+Rc), s		87.4			87.4	17.6
Change Period (Y+Rc), s		5.0			5.0	4.5
Max Green Setting (Gmax), s		60.0			60.0	35.5
Max Q Clear Time (g_c+I1), s		2.0			8.4	12.3
Green Ext Time (p_c), s		15.8			10.4	0.8

Intersection Summary

HCM 6th Ctrl Delay	8.4
HCM 6th LOS	A

Notes

Unsignalized Delay for [NBR, EBR] is excluded from calculations of the approach delay and intersection delay.

Intersection						
Int Delay, s/veh	1.1					
Movement	EBL	EBT	WBT	WBR	SBL	SBR
Lane Configurations		↕	↕		↕	
Traffic Vol, veh/h	32	190	140	14	11	8
Future Vol, veh/h	32	190	140	14	11	8
Conflicting Peds, #/hr	2	0	0	2	2	2
Sign Control	Free	Free	Free	Free	Stop	Stop
RT Channelized	-	None	-	None	-	None
Storage Length	-	-	-	-	-	-
Veh in Median Storage, #	-	0	0	-	0	-
Grade, %	-	0	0	-	0	-
Peak Hour Factor	92	92	92	92	92	92
Heavy Vehicles, %	1	1	0	0	0	0
Mvmt Flow	35	207	152	15	12	9

Major/Minor	Major1	Major2	Minor2		
Conflicting Flow All	169	0	-	0	441 164
Stage 1	-	-	-	-	162 -
Stage 2	-	-	-	-	279 -
Critical Hdwy	4.11	-	-	-	6.4 6.2
Critical Hdwy Stg 1	-	-	-	-	5.4 -
Critical Hdwy Stg 2	-	-	-	-	5.4 -
Follow-up Hdwy	2.209	-	-	-	3.5 3.3
Pot Cap-1 Maneuver	1415	-	-	-	577 886
Stage 1	-	-	-	-	872 -
Stage 2	-	-	-	-	773 -
Platoon blocked, %		-	-	-	
Mov Cap-1 Maneuver	1412	-	-	-	559 883
Mov Cap-2 Maneuver	-	-	-	-	559 -
Stage 1	-	-	-	-	846 -
Stage 2	-	-	-	-	771 -

Approach	EB	WB	SB
HCM Control Delay, s	1.1	0	10.6
HCM LOS			B

Minor Lane/Major Mvmt	EBL	EBT	WBT	WBR	SBLn1
Capacity (veh/h)	1412	-	-	-	661
HCM Lane V/C Ratio	0.025	-	-	-	0.031
HCM Control Delay (s)	7.6	0	-	-	10.6
HCM Lane LOS	A	A	-	-	B
HCM 95th %tile Q(veh)	0.1	-	-	-	0.1

HCM 6th TWSC
 13: SW Norwood Road & SW Vermillion Drive

08/31/2021

Intersection						
Int Delay, s/veh	2.9					
Movement	EBL	EBT	WBT	WBR	SBL	SBR
Lane Configurations		↕	↕		↕	
Traffic Vol, veh/h	68	133	118	37	23	36
Future Vol, veh/h	68	133	118	37	23	36
Conflicting Peds, #/hr	0	0	0	0	0	0
Sign Control	Free	Free	Free	Free	Stop	Stop
RT Channelized	-	None	-	None	-	None
Storage Length	-	-	-	-	-	-
Veh in Median Storage, #	-	0	0	-	0	-
Grade, %	-	0	0	-	0	-
Peak Hour Factor	72	72	72	72	72	72
Heavy Vehicles, %	1	1	0	0	0	0
Mvmt Flow	94	185	164	51	32	50

Major/Minor	Major1	Major2	Minor2		
Conflicting Flow All	215	0	-	0	563 190
Stage 1	-	-	-	-	190 -
Stage 2	-	-	-	-	373 -
Critical Hdwy	4.11	-	-	-	6.4 6.2
Critical Hdwy Stg 1	-	-	-	-	5.4 -
Critical Hdwy Stg 2	-	-	-	-	5.4 -
Follow-up Hdwy	2.209	-	-	-	3.5 3.3
Pot Cap-1 Maneuver	1361	-	-	-	491 857
Stage 1	-	-	-	-	847 -
Stage 2	-	-	-	-	701 -
Platoon blocked, %		-	-	-	
Mov Cap-1 Maneuver	1361	-	-	-	453 857
Mov Cap-2 Maneuver	-	-	-	-	453 -
Stage 1	-	-	-	-	782 -
Stage 2	-	-	-	-	701 -

Approach	EB	WB	SB
HCM Control Delay, s	2.7	0	11.5
HCM LOS			B

Minor Lane/Major Mvmt	EBL	EBT	WBT	WBR	SBLn1
Capacity (veh/h)	1361	-	-	-	636
HCM Lane V/C Ratio	0.069	-	-	-	0.129
HCM Control Delay (s)	7.8	0	-	-	11.5
HCM Lane LOS	A	A	-	-	B
HCM 95th %tile Q(veh)	0.2	-	-	-	0.4

HCM 6th TWSC
 14: SW 82nd Avenue & SW Norwood Road/Driveway

08/31/2021

Intersection												
Int Delay, s/veh	6.8											
Movement	EBL	EBT	EBR	WBL	WBT	WBR	NBL	NBT	NBR	SBL	SBT	SBR
Lane Configurations		↕			↕			↕			↕	↗
Traffic Vol, veh/h	122	0	34	0	0	1	20	7	0	2	4	135
Future Vol, veh/h	122	0	34	0	0	1	20	7	0	2	4	135
Conflicting Peds, #/hr	0	0	0	0	0	0	0	0	0	0	0	0
Sign Control	Free	Free	Free	Free	Free	Free	Stop	Stop	Stop	Stop	Stop	Stop
RT Channelized	-	-	None	-	-	None	-	-	None	-	-	Free
Storage Length	-	-	-	-	-	-	-	-	-	-	-	15
Veh in Median Storage, #	-	0	-	-	0	-	-	0	-	-	0	-
Grade, %	-	0	-	-	0	-	-	0	-	-	0	-
Peak Hour Factor	83	83	83	83	83	83	83	83	83	83	83	83
Heavy Vehicles, %	0	0	0	0	0	0	0	0	0	0	0	0
Mvmt Flow	147	0	41	0	0	1	24	8	0	2	5	163

Major/Minor	Major1			Major2			Minor1			Minor2		
Conflicting Flow All	1	0	0	41	0	0	318	316	21	320	336	-
Stage 1	-	-	-	-	-	-	315	315	-	1	1	-
Stage 2	-	-	-	-	-	-	3	1	-	319	335	-
Critical Hdwy	4.1	-	-	4.1	-	-	7.1	6.5	6.2	7.1	6.5	-
Critical Hdwy Stg 1	-	-	-	-	-	-	6.1	5.5	-	6.1	5.5	-
Critical Hdwy Stg 2	-	-	-	-	-	-	6.1	5.5	-	6.1	5.5	-
Follow-up Hdwy	2.2	-	-	2.2	-	-	3.5	4	3.3	3.5	4	-
Pot Cap-1 Maneuver	1635	-	-	1581	-	-	639	603	1062	637	588	0
Stage 1	-	-	-	-	-	-	700	659	-	1027	899	0
Stage 2	-	-	-	-	-	-	1025	899	-	697	646	0
Platoon blocked, %	-	-	-	-	-	-	-	-	-	-	-	-
Mov Cap-1 Maneuver	1635	-	-	1581	-	-	590	548	1062	585	534	-
Mov Cap-2 Maneuver	-	-	-	-	-	-	590	548	-	585	534	-
Stage 1	-	-	-	-	-	-	636	598	-	933	899	-
Stage 2	-	-	-	-	-	-	1020	899	-	624	587	-

Approach	EB			WB			NB			SB		
HCM Control Delay, s	5.8			0			11.6			11.6		
HCM LOS							B			B		

Minor Lane/Major Mvmt	NBLn1	EBL	EBT	EBR	WBL	WBT	WBR	SBLn1	SBLn2
Capacity (veh/h)	579	1635	-	-	1581	-	-	550	-
HCM Lane V/C Ratio	0.056	0.09	-	-	-	-	-	0.013	-
HCM Control Delay (s)	11.6	7.4	0	-	0	-	-	11.6	0
HCM Lane LOS	B	A	A	-	A	-	-	B	A
HCM 95th %tile Q(veh)	0.2	0.3	-	-	0	-	-	0	-

HCM 6th TWSC
 15: SW 65th Avenue & SW Norwood Road

08/31/2021

Intersection						
Int Delay, s/veh	3.2					
Movement	EBL	EBR	NBL	NBT	SBT	SBR
Lane Configurations	T			T		T
Traffic Vol, veh/h	65	61	54	218	388	109
Future Vol, veh/h	65	61	54	218	388	109
Conflicting Peds, #/hr	0	0	0	0	0	0
Sign Control	Stop	Stop	Free	Free	Free	Free
RT Channelized	-	None	-	None	-	None
Storage Length	-	-	-	-	-	-
Veh in Median Storage, #	0	-	-	0	0	-
Grade, %	0	-	-	0	0	-
Peak Hour Factor	89	89	89	89	89	89
Heavy Vehicles, %	0	0	2	2	0	0
Mvmt Flow	73	69	61	245	436	122

Major/Minor	Minor2	Major1	Major2			
Conflicting Flow All	864	497	558	0	-	0
Stage 1	497	-	-	-	-	-
Stage 2	367	-	-	-	-	-
Critical Hdwy	6.4	6.2	4.12	-	-	-
Critical Hdwy Stg 1	5.4	-	-	-	-	-
Critical Hdwy Stg 2	5.4	-	-	-	-	-
Follow-up Hdwy	3.5	3.3	2.218	-	-	-
Pot Cap-1 Maneuver	327	577	1013	-	-	-
Stage 1	615	-	-	-	-	-
Stage 2	705	-	-	-	-	-
Platoon blocked, %				-	-	-
Mov Cap-1 Maneuver	304	577	1013	-	-	-
Mov Cap-2 Maneuver	304	-	-	-	-	-
Stage 1	572	-	-	-	-	-
Stage 2	705	-	-	-	-	-

Approach	EB	NB	SB
HCM Control Delay, s	19.2	1.7	0
HCM LOS	C		

Minor Lane/Major Mvmt	NBL	NBT	EBLn1	SBT	SBR
Capacity (veh/h)	1013	-	394	-	-
HCM Lane V/C Ratio	0.06	-	0.359	-	-
HCM Control Delay (s)	8.8	0	19.2	-	-
HCM Lane LOS	A	A	C	-	-
HCM 95th %tile Q(veh)	0.2	-	1.6	-	-

HCM 6th Signalized Intersection Summary
 1: SW Boones Ferry Rd & SW Sagert St

06/24/2021



Movement	EBL	EBT	EBR	WBL	WBT	WBR	NBL	NBT	NBR	SBL	SBT	SBR
Lane Configurations												
Traffic Volume (veh/h)	73	80	12	184	102	63	8	613	291	53	280	48
Future Volume (veh/h)	73	80	12	184	102	63	8	613	291	53	280	48
Initial Q (Qb), veh	0	0	0	0	0	0	0	0	0	0	0	0
Ped-Bike Adj(A_pbT)	1.00		0.99	1.00		1.00	1.00		0.98	1.00		0.98
Parking Bus, Adj	1.00	1.00	1.00	1.00	1.00	1.00	1.00	1.00	1.00	1.00	1.00	1.00
Work Zone On Approach		No			No			No			No	
Adj Sat Flow, veh/h/ln	1885	1885	1885	1900	1900	1900	1885	1885	1885	1811	1811	1811
Adj Flow Rate, veh/h	80	88	8	202	112	47	9	674	304	58	308	31
Peak Hour Factor	0.91	0.91	0.91	0.91	0.91	0.91	0.91	0.91	0.91	0.91	0.91	0.91
Percent Heavy Veh, %	1	1	1	0	0	0	1	1	1	6	6	6
Cap, veh/h	251	138	13	329	176	74	663	714	322	195	1114	923
Arrive On Green	0.06	0.08	0.08	0.12	0.14	0.13	0.02	0.58	0.57	0.05	0.62	0.62
Sat Flow, veh/h	1795	1701	155	1810	1269	533	1795	1221	551	1725	1811	1501
Grp Volume(v), veh/h	80	0	96	202	0	159	9	0	978	58	308	31
Grp Sat Flow(s),veh/h/ln	1795	0	1856	1810	0	1802	1795	0	1771	1725	1811	1501
Q Serve(g_s), s	3.8	0.0	4.7	9.2	0.0	7.8	0.2	0.0	48.1	1.2	7.4	0.8
Cycle Q Clear(g_c), s	3.8	0.0	4.7	9.2	0.0	7.8	0.2	0.0	48.1	1.2	7.4	0.8
Prop In Lane	1.00		0.08	1.00		0.30	1.00		0.31	1.00		1.00
Lane Grp Cap(c), veh/h	251	0	150	329	0	250	663	0	1036	195	1114	923
V/C Ratio(X)	0.32	0.00	0.64	0.61	0.00	0.64	0.01	0.00	0.94	0.30	0.28	0.03
Avail Cap(c_a), veh/h	355	0	316	329	0	307	844	0	1057	316	1114	923
HCM Platoon Ratio	1.00	1.00	1.00	1.00	1.00	1.00	1.00	1.00	1.00	1.00	1.00	1.00
Upstream Filter(l)	1.00	0.00	1.00	1.00	0.00	1.00	1.00	0.00	1.00	1.00	1.00	1.00
Uniform Delay (d), s/veh	36.3	0.0	41.8	32.5	0.0	38.3	7.8	0.0	18.2	20.7	8.4	7.1
Incr Delay (d2), s/veh	0.3	0.0	1.7	2.5	0.0	1.4	0.0	0.0	16.2	0.3	0.2	0.0
Initial Q Delay(d3),s/veh	0.0	0.0	0.0	0.0	0.0	0.0	0.0	0.0	0.0	0.0	0.0	0.0
%ile BackOfQ(50%),veh/ln	1.6	0.0	2.2	4.2	0.0	3.5	0.1	0.0	22.1	0.7	2.7	0.2
Unsig. Movement Delay, s/veh												
LnGrp Delay(d),s/veh	36.6	0.0	43.5	35.0	0.0	39.7	7.8	0.0	34.5	21.0	8.6	7.1
LnGrp LOS	D	A	D	C	A	D	A	A	C	C	A	A
Approach Vol, veh/h		176			361			987			397	
Approach Delay, s/veh		40.4			37.0			34.2			10.3	
Approach LOS		D			D			C			B	
Timer - Assigned Phs	1	2	3	4	5	6	7	8				
Phs Duration (G+Y+Rc), s	8.4	58.9	15.0	11.6	5.5	61.7	9.6	17.0				
Change Period (Y+Rc), s	4.5	5.0	4.5	4.5	4.5	5.0	4.5	4.5				
Max Green Setting (Gmax), s	10.5	55.0	10.5	15.5	10.5	55.0	10.5	15.5				
Max Q Clear Time (g_c+I1), s	3.2	50.1	11.2	6.7	2.2	9.4	5.8	9.8				
Green Ext Time (p_c), s	0.0	3.8	0.0	0.2	0.0	3.8	0.0	0.2				

Intersection Summary

HCM 6th Ctrl Delay	30.4
HCM 6th LOS	C

Notes

User approved pedestrian interval to be less than phase max green.

HCM 6th Signalized Intersection Summary

2: SW Boones Ferry Rd & SW Avery St

06/24/2021



Movement	EBL	EBT	EBR	WBL	WBT	WBR	NBL	NBT	NBR	SBL	SBT	SBR
Lane Configurations												
Traffic Volume (veh/h)	178	70	147	31	107	15	263	719	42	7	310	160
Future Volume (veh/h)	178	70	147	31	107	15	263	719	42	7	310	160
Initial Q (Qb), veh	0	0	0	0	0	0	0	0	0	0	0	0
Ped-Bike Adj(A_pbT)	1.00		0.97	0.99		0.96	1.00		0.98	1.00		1.00
Parking Bus, Adj	1.00	1.00	1.00	1.00	1.00	1.00	1.00	1.00	1.00	1.00	1.00	1.00
Work Zone On Approach		No		No		No		No		No		No
Adj Sat Flow, veh/h/ln	1841	1841	1841	1841	1841	1841	1767	1767	1767	1841	1841	1841
Adj Flow Rate, veh/h	212	83	98	37	127	12	313	856	44	8	369	172
Peak Hour Factor	0.84	0.84	0.84	0.84	0.84	0.84	0.84	0.84	0.84	0.84	0.84	0.84
Percent Heavy Veh, %	4	4	4	4	4	4	9	9	9	4	4	4
Cap, veh/h	326	152	179	242	178	17	432	973	50	173	630	294
Arrive On Green	0.13	0.20	0.19	0.03	0.11	0.10	0.06	0.59	0.57	0.01	0.53	0.53
Sat Flow, veh/h	1753	756	892	1753	1649	156	1682	1663	85	1753	1186	553
Grp Volume(v), veh/h	212	0	181	37	0	139	313	0	900	8	0	541
Grp Sat Flow(s),veh/h/ln	1753	0	1648	1753	0	1805	1682	0	1749	1753	0	1739
Q Serve(g_s), s	9.7	0.0	9.3	1.8	0.0	7.0	6.0	0.0	41.2	0.2	0.0	19.8
Cycle Q Clear(g_c), s	9.7	0.0	9.3	1.8	0.0	7.0	6.0	0.0	41.2	0.2	0.0	19.8
Prop In Lane	1.00		0.54	1.00		0.09	1.00		0.05	1.00		0.32
Lane Grp Cap(c), veh/h	326	0	331	242	0	195	432	0	1023	173	0	924
V/C Ratio(X)	0.65	0.00	0.55	0.15	0.00	0.71	0.72	0.00	0.88	0.05	0.00	0.59
Avail Cap(c_a), veh/h	498	0	458	296	0	212	432	0	1233	268	0	1227
HCM Platoon Ratio	1.00	1.00	1.00	1.00	1.00	1.00	1.00	1.00	1.00	1.00	1.00	1.00
Upstream Filter(I)	1.00	0.00	1.00	1.00	0.00	1.00	1.00	0.00	1.00	1.00	0.00	1.00
Uniform Delay (d), s/veh	30.9	0.0	33.8	36.2	0.0	40.4	17.8	0.0	16.6	17.7	0.0	14.9
Incr Delay (d2), s/veh	0.8	0.0	0.5	0.1	0.0	8.0	5.2	0.0	7.1	0.0	0.0	0.8
Initial Q Delay(d3),s/veh	0.0	0.0	0.0	0.0	0.0	0.0	0.0	0.0	0.0	0.0	0.0	0.0
%ile BackOfQ(50%),veh/ln	4.1	0.0	3.7	0.8	0.0	3.5	3.8	0.0	16.7	0.1	0.0	7.5
Unsig. Movement Delay, s/veh												
LnGrp Delay(d),s/veh	31.7	0.0	34.3	36.3	0.0	48.4	22.9	0.0	23.7	17.7	0.0	15.8
LnGrp LOS	C	A	C	D	A	D	C	A	C	B	A	B
Approach Vol, veh/h		393			176			1213			549	
Approach Delay, s/veh		32.9			45.8			23.5			15.8	
Approach LOS		C			D			C			B	
Timer - Assigned Phs	1	2	3	4	5	6	7	8				
Phs Duration (G+Y+Rc), s	4.9	58.7	7.1	22.8	10.0	53.7	15.8	14.1				
Change Period (Y+Rc), s	4.0	5.5	4.0	5.0	4.0	5.5	4.0	5.0				
Max Green Setting (Gmax), s	6.0	64.5	6.0	25.0	6.0	64.5	21.0	10.0				
Max Q Clear Time (g_c+1/2g), s	12.2	43.2	3.8	11.3	8.0	21.8	11.7	9.0				
Green Ext Time (p_c), s	0.0	10.1	0.0	0.6	0.0	6.3	0.1	0.0				

Intersection Summary

HCM 6th Ctrl Delay	25.0
HCM 6th LOS	C

Notes

User approved pedestrian interval to be less than phase max green.

HCM 6th Signalized Intersection Summary

3: SW Boones Ferry Road & SW Ibach Street/SW Ibach Court

06/24/2021



Movement	EBL	EBT	EBR	WBL	WBT	WBR	NBL	NBT	NBR	SBL	SBT	SBR
Lane Configurations												
Traffic Volume (veh/h)	262	4	343	4	1	19	134	743	10	3	398	87
Future Volume (veh/h)	262	4	343	4	1	19	134	743	10	3	398	87
Initial Q (Qb), veh	0	0	0	0	0	0	0	0	0	0	0	0
Ped-Bike Adj(A_pbT)	0.98		0.99	1.00		0.97	1.00		0.99	1.00		0.99
Parking Bus, Adj	1.00	1.00	1.00	1.00	1.00	1.00	1.00	1.00	1.00	1.00	1.00	1.00
Work Zone On Approach		No			No			No			No	
Adj Sat Flow, veh/h/ln	1856	1856	1856	1900	1900	1900	1796	1796	1796	1811	1811	1811
Adj Flow Rate, veh/h	301	5	222	5	1	5	154	854	11	3	457	54
Peak Hour Factor	0.87	0.87	0.87	0.87	0.87	0.87	0.87	0.87	0.87	0.87	0.87	0.87
Percent Heavy Veh, %	3	3	3	0	0	0	7	7	7	6	6	6
Cap, veh/h	434	10	433	164	49	123	188	998	13	6	828	698
Arrive On Green	0.28	0.28	0.28	0.28	0.28	0.28	0.11	0.56	0.55	0.00	0.46	0.46
Sat Flow, veh/h	1367	34	1529	348	171	433	1711	1769	23	1725	1811	1526
Grp Volume(v), veh/h	301	0	227	11	0	0	154	0	865	3	457	54
Grp Sat Flow(s),veh/h/ln	1367	0	1564	953	0	0	1711	0	1792	1725	1811	1526
Q Serve(g_s), s	9.6	0.0	9.8	0.1	0.0	0.0	7.1	0.0	32.7	0.1	14.7	1.6
Cycle Q Clear(g_c), s	19.5	0.0	9.8	9.9	0.0	0.0	7.1	0.0	32.7	0.1	14.7	1.6
Prop In Lane	1.00		0.98	0.45		0.45	1.00		0.01	1.00		1.00
Lane Grp Cap(c), veh/h	434	0	443	329	0	0	188	0	1011	6	828	698
V/C Ratio(X)	0.69	0.00	0.51	0.03	0.00	0.00	0.82	0.00	0.86	0.54	0.55	0.08
Avail Cap(c_a), veh/h	490	0	507	385	0	0	234	0	1250	236	1264	1065
HCM Platoon Ratio	1.00	1.00	1.00	1.00	1.00	1.00	1.00	1.00	1.00	1.00	1.00	1.00
Upstream Filter(I)	1.00	0.00	1.00	1.00	0.00	0.00	1.00	0.00	1.00	1.00	1.00	1.00
Uniform Delay (d), s/veh	28.3	0.0	24.3	21.3	0.0	0.0	34.9	0.0	14.7	39.9	15.8	12.2
Incr Delay (d2), s/veh	3.0	0.0	0.6	0.0	0.0	0.0	14.8	0.0	5.8	41.6	0.9	0.1
Initial Q Delay(d3),s/veh	0.0	0.0	0.0	0.0	0.0	0.0	0.0	0.0	0.0	0.0	0.0	0.0
%ile BackOfQ(50%),veh/ln	5.7	0.0	3.6	0.2	0.0	0.0	3.6	0.0	12.7	0.1	5.7	0.5
Unsig. Movement Delay, s/veh												
LnGrp Delay(d),s/veh	31.3	0.0	24.9	21.3	0.0	0.0	49.8	0.0	20.5	81.6	16.7	12.3
LnGrp LOS	C	A	C	C	A	A	D	A	C	F	B	B
Approach Vol, veh/h		528			11			1019			514	
Approach Delay, s/veh		28.6			21.3			24.9			16.6	
Approach LOS		C			C			C			B	
Timer - Assigned Phs	1	2		4	5	6		8				
Phs Duration (G+Y+Rc), s	4.3	49.3		26.7	12.8	40.7		26.7				
Change Period (Y+Rc), s	4.0	5.0		4.5	4.0	5.0		4.5				
Max Green Setting (Gmax), s	1.0	55.0		25.5	11.0	55.0		25.5				
Max Q Clear Time (g_c+1/2, s)	1.0	34.7		21.5	9.1	16.7		11.9				
Green Ext Time (p_c), s	0.0	9.6		0.7	0.0	5.4		0.0				
Intersection Summary												
HCM 6th Ctrl Delay											23.8	
HCM 6th LOS											C	

HCM 6th TWSC
4: SW Boones Ferry Road & SW Iowa Drive

06/24/2021

Intersection												
Int Delay, s/veh	10.9											
Movement	EBL	EBT	EBR	WBL	WBT	WBR	NBL	NBT	NBR	SBL	SBT	SBR
Lane Configurations		↕			↕		↕	↕		↕	↕	
Traffic Vol, veh/h	51	2	56	30	0	32	14	685	10	20	456	18
Future Vol, veh/h	51	2	56	30	0	32	14	685	10	20	456	18
Conflicting Peds, #/hr	13	0	5	1	0	9	5	0	1	9	0	13
Sign Control	Stop	Stop	Stop	Stop	Stop	Stop	Free	Free	Free	Free	Free	Free
RT Channelized	-	-	None	-	-	None	-	-	None	-	-	None
Storage Length	-	-	-	-	-	-	95	-	-	105	-	-
Veh in Median Storage, #	-	0	-	-	0	-	-	0	-	-	0	-
Grade, %	-	0	-	-	0	-	-	0	-	-	0	-
Peak Hour Factor	84	84	84	84	84	84	84	84	84	84	84	84
Heavy Vehicles, %	0	0	0	0	0	0	7	7	7	6	6	6
Mvmt Flow	61	2	67	36	0	38	17	815	12	24	543	21

Major/Minor	Minor2		Minor1		Major1			Major2				
Conflicting Flow All	1502	1485	572	1505	1489	843	577	0	0	836	0	0
Stage 1	615	615	-	864	864	-	-	-	-	-	-	-
Stage 2	887	870	-	641	625	-	-	-	-	-	-	-
Critical Hdwy	7.1	6.5	6.2	7.1	6.5	6.2	4.17	-	-	4.16	-	-
Critical Hdwy Stg 1	6.1	5.5	-	6.1	5.5	-	-	-	-	-	-	-
Critical Hdwy Stg 2	6.1	5.5	-	6.1	5.5	-	-	-	-	-	-	-
Follow-up Hdwy	3.5	4	3.3	3.5	4	3.3	2.263	-	-	2.254	-	-
Pot Cap-1 Maneuver	101	126	523	101	125	367	972	-	-	781	-	-
Stage 1	482	485	-	352	374	-	-	-	-	-	-	-
Stage 2	341	372	-	466	480	-	-	-	-	-	-	-
Platoon blocked, %								-	-	-	-	-
Mov Cap-1 Maneuver	85	117	514	82	117	359	960	-	-	774	-	-
Mov Cap-2 Maneuver	85	117	-	82	117	-	-	-	-	-	-	-
Stage 1	468	464	-	343	364	-	-	-	-	-	-	-
Stage 2	296	362	-	389	459	-	-	-	-	-	-	-

Approach	EB		WB		NB		SB	
HCM Control Delay, s	100		59.2		0.2		0.4	
HCM LOS	F		F					

Minor Lane/Major Mvmt	NBL	NBT	NBR	EBLn1WBLn1	SBL	SBT	SBR
Capacity (veh/h)	960	-	-	150	136	774	-
HCM Lane V/C Ratio	0.017	-	-	0.865	0.543	0.031	-
HCM Control Delay (s)	8.8	-	-	100	59.2	9.8	-
HCM Lane LOS	A	-	-	F	F	A	-
HCM 95th %tile Q(veh)	0.1	-	-	5.8	2.7	0.1	-

HCM 6th TWSC
5: SW Boones Ferry Road & SW Norwood Road

06/24/2021

Intersection						
Int Delay, s/veh	3.2					
Movement	WBL	WBR	NBT	NBR	SBL	SBT
Lane Configurations	Y		↑	↑	↑	↑
Traffic Vol, veh/h	79	61	649	36	53	489
Future Vol, veh/h	79	61	649	36	53	489
Conflicting Peds, #/hr	4	4	0	4	4	0
Sign Control	Stop	Stop	Free	Free	Free	Free
RT Channelized	-	None	-	None	-	None
Storage Length	-	-	-	65	290	-
Veh in Median Storage, #	0	-	0	-	-	0
Grade, %	0	-	0	-	-	0
Peak Hour Factor	87	87	87	87	87	87
Heavy Vehicles, %	2	2	6	6	5	5
Mvmt Flow	91	70	746	41	61	562

Major/Minor	Minor1	Major1	Major2		
Conflicting Flow All	1438	754	0	0	791
Stage 1	750	-	-	-	-
Stage 2	688	-	-	-	-
Critical Hdwy	6.42	6.22	-	-	4.15
Critical Hdwy Stg 1	5.42	-	-	-	-
Critical Hdwy Stg 2	5.42	-	-	-	-
Follow-up Hdwy	3.518	3.318	-	-	2.245
Pot Cap-1 Maneuver	147	409	-	-	816
Stage 1	467	-	-	-	-
Stage 2	499	-	-	-	-
Platoon blocked, %			-	-	-
Mov Cap-1 Maneuver	135	406	-	-	813
Mov Cap-2 Maneuver	273	-	-	-	-
Stage 1	465	-	-	-	-
Stage 2	460	-	-	-	-

Approach	WB	NB	SB
HCM Control Delay, s	27.4	0	1
HCM LOS	D		

Minor Lane/Major Mvmt	NBT	NBRWBLn1	SBL	SBT
Capacity (veh/h)	-	-	318	813
HCM Lane V/C Ratio	-	-	0.506	0.075
HCM Control Delay (s)	-	-	27.4	9.8
HCM Lane LOS	-	-	D	A
HCM 95th %tile Q(veh)	-	-	2.7	0.2

Intersection						
Int Delay, s/veh	0					
Movement	WBL	WBR	NBT	NBR	SBL	SBT
Lane Configurations	↔		↔		↔	↔
Traffic Vol, veh/h	2	1	675	0	0	577
Future Vol, veh/h	2	1	675	0	0	577
Conflicting Peds, #/hr	4	4	0	4	4	0
Sign Control	Stop	Stop	Free	Free	Free	Free
RT Channelized	-	None	-	None	-	None
Storage Length	-	-	-	-	150	-
Veh in Median Storage, #	2	-	0	-	-	0
Grade, %	0	-	0	-	-	0
Peak Hour Factor	87	87	87	87	87	87
Heavy Vehicles, %	0	0	6	6	5	5
Mvmt Flow	2	1	776	0	0	663

Major/Minor	Minor1	Major1	Major2		
Conflicting Flow All	1447	784	0	0	780
Stage 1	780	-	-	-	-
Stage 2	667	-	-	-	-
Critical Hdwy	6.4	6.2	-	-	4.15
Critical Hdwy Stg 1	5.4	-	-	-	-
Critical Hdwy Stg 2	5.4	-	-	-	-
Follow-up Hdwy	3.5	3.3	-	-	2.245
Pot Cap-1 Maneuver	146	396	-	-	824
Stage 1	455	-	-	-	-
Stage 2	514	-	-	-	-
Platoon blocked, %			-	-	-
Mov Cap-1 Maneuver	145	393	-	-	821
Mov Cap-2 Maneuver	349	-	-	-	-
Stage 1	453	-	-	-	-
Stage 2	512	-	-	-	-

Approach	WB	NB	SB
HCM Control Delay, s	15	0	0
HCM LOS	C		

Minor Lane/Major Mvmt	NBT	NBRWBLn1	SBL	SBT
Capacity (veh/h)	-	-	363	821
HCM Lane V/C Ratio	-	-	0.009	-
HCM Control Delay (s)	-	-	15	0
HCM Lane LOS	-	-	C	A
HCM 95th %tile Q(veh)	-	-	0	0

HCM 6th Signalized Intersection Summary
 8: SW Boones Ferry Road & SW Day Road

06/24/2021



Movement	EBL	EBT	EBR	WBL	WBT	WBR	NBL	NBT	NBR	SBL	SBT	SBR
Lane Configurations		↖	↗		↔		↖↗	↕		↖	↕↗	
Traffic Volume (veh/h)	179	0	581	0	0	0	642	496	0	0	523	55
Future Volume (veh/h)	179	0	581	0	0	0	642	496	0	0	523	55
Initial Q (Qb), veh	0	0	0	0	0	0	0	0	0	0	0	0
Ped-Bike Adj(A_pbT)	1.00		1.00	1.00		1.00	1.00		1.00	1.00		1.00
Parking Bus, Adj	1.00	1.00	1.00	1.00	1.00	1.00	1.00	1.00	1.00	1.00	1.00	1.00
Work Zone On Approach		No			No			No			No	
Adj Sat Flow, veh/h/ln	1693	1693	1693	1900	1900	1900	1693	1693	1693	1796	1796	1796
Adj Flow Rate, veh/h	199	0	596	0	0	0	713	551	0	0	581	50
Peak Hour Factor	0.90	0.90	0.90	0.90	0.90	0.90	0.90	0.90	0.90	0.90	0.90	0.90
Percent Heavy Veh, %	14	14	14	0	0	0	14	14	14	7	7	7
Cap, veh/h	288	0	675	0	320	0	816	700	0	483	1265	109
Arrive On Green	0.16	0.00	0.17	0.00	0.00	0.00	0.10	0.14	0.00	0.00	0.40	0.38
Sat Flow, veh/h	1283	0	1434	0	1900	0	2740	1693	0	1711	3180	273
Grp Volume(v), veh/h	199	0	596	0	0	0	713	551	0	0	311	320
Grp Sat Flow(s),veh/h/ln	1283	0	1434	0	1900	0	1370	1693	0	1711	1706	1747
Q Serve(g_s), s	14.6	0.0	16.2	0.0	0.0	0.0	24.4	29.9	0.0	0.0	12.8	12.8
Cycle Q Clear(g_c), s	14.6	0.0	16.2	0.0	0.0	0.0	24.4	29.9	0.0	0.0	12.8	12.8
Prop In Lane	1.00		1.00	0.00		0.00	1.00		0.00	1.00		0.16
Lane Grp Cap(c), veh/h	285	0	675	0	320	0	816	700	0	483	679	695
V/C Ratio(X)	0.70	0.00	0.88	0.00	0.00	0.00	0.87	0.79	0.00	0.00	0.46	0.46
Avail Cap(c_a), veh/h	285	0	675	0	320	0	1041	1033	0	483	679	695
HCM Platoon Ratio	1.00	1.00	1.00	1.00	1.00	1.00	0.33	0.33	0.33	1.00	1.00	1.00
Upstream Filter(I)	1.00	0.00	1.00	0.00	0.00	0.00	0.90	0.90	0.00	0.00	1.00	1.00
Uniform Delay (d), s/veh	39.3	0.0	22.8	0.0	0.0	0.0	41.1	37.0	0.0	0.0	21.1	21.2
Incr Delay (d2), s/veh	6.8	0.0	13.0	0.0	0.0	0.0	5.6	7.9	0.0	0.0	2.2	2.2
Initial Q Delay(d3),s/veh	0.0	0.0	0.0	0.0	0.0	0.0	0.0	0.0	0.0	0.0	0.0	0.0
%ile BackOfQ(50%),veh/ln	5.0	0.0	13.3	0.0	0.0	0.0	9.5	15.0	0.0	0.0	5.1	5.3
Unsig. Movement Delay, s/veh												
LnGrp Delay(d),s/veh	46.1	0.0	35.8	0.0	0.0	0.0	46.7	44.9	0.0	0.0	23.3	23.4
LnGrp LOS	D	A	D	A	A	A	D	D	A	A	C	C
Approach Vol, veh/h		795			0			1264			631	
Approach Delay, s/veh		38.4			0.0			45.9			23.3	
Approach LOS		D						D			C	
Timer - Assigned Phs	1	2		4	5	6		8				
Phs Duration (G+Y+Rc), s	33.2	41.8		20.0	31.7	43.3		20.0				
Change Period (Y+Rc), s	* 5.4	* 5.4		4.5	* 5.4	* 5.4		4.5				
Max Green Setting (Gmax), s	* 36	* 29		15.5	* 8.5	* 57		15.5				
Max Q Clear Time (g_c+I1), s	26.4	14.8		0.0	0.0	31.9		18.2				
Green Ext Time (p_c), s	1.4	4.5		0.0	0.0	6.0		0.0				

Intersection Summary

HCM 6th Ctrl Delay	38.4
HCM 6th LOS	D

Notes

- User approved pedestrian interval to be less than phase max green.
- * HCM 6th computational engine requires equal clearance times for the phases crossing the barrier.

HCM 6th Signalized Intersection Summary

9: SW Elligsen Road/SW Boones Ferry Road & SW 95th Avenue

06/24/2021



Movement	EBL	EBT	EBR	WBL	WBT	WBR	NBL	NBT	NBR	SBL	SBT	SBR
Lane Configurations		↕	↗	↖	↗	↖	↗	↖		↖	↗	↖
Traffic Volume (veh/h)	208	8	560	17	1	7	846	842	70	6	743	273
Future Volume (veh/h)	208	8	560	17	1	7	846	842	70	6	743	273
Initial Q (Qb), veh	0	0	0	0	0	0	0	0	0	0	0	0
Ped-Bike Adj(A_pbT)	1.00		0.99	1.00		1.00	1.00		1.00	1.00		1.00
Parking Bus, Adj	1.00	1.00	1.00	1.00	1.00	1.00	1.00	1.00	1.00	1.00	1.00	1.00
Work Zone On Approach		No		No		No		No		No		No
Adj Sat Flow, veh/h/ln	1648	1648	1648	1737	1737	1737	1796	1796	1796	1737	1737	1737
Adj Flow Rate, veh/h	226	9	571	18	1	8	920	915	76	7	808	0
Peak Hour Factor	0.92	0.92	0.92	0.92	0.92	0.92	0.92	0.92	0.92	0.92	0.92	0.92
Percent Heavy Veh, %	17	17	17	11	11	11	7	7	7	11	11	11
Cap, veh/h	296	9	1222	76	31	251	1025	1206	100	454	1135	
Arrive On Green	0.19	0.19	0.19	0.19	0.19	0.19	0.52	0.63	0.63	0.09	0.11	0.00
Sat Flow, veh/h	1168	47	2445	775	166	1327	3319	3190	265	1654	3300	1472
Grp Volume(v), veh/h	235	0	571	18	0	9	920	490	501	7	808	0
Grp Sat Flow(s),veh/h/ln	1215	0	1223	775	0	1493	1659	1706	1748	1654	1650	1472
Q Serve(g_s), s	17.5	0.0	14.5	0.0	0.0	0.5	23.8	19.3	19.3	0.4	22.4	0.0
Cycle Q Clear(g_c), s	18.0	0.0	14.5	18.0	0.0	0.5	23.8	19.3	19.3	0.4	22.4	0.0
Prop In Lane	0.96		1.00	1.00		0.89	1.00		0.15	1.00		1.00
Lane Grp Cap(c), veh/h	304	0	1222	76	0	283	1025	645	661	454	1135	
V/C Ratio(X)	0.77	0.00	0.47	0.24	0.00	0.03	0.90	0.76	0.76	0.02	0.71	
Avail Cap(c_a), veh/h	304	0	1222	76	0	283	1572	988	1012	454	1135	
HCM Platoon Ratio	1.00	1.00	1.00	1.00	1.00	1.00	1.67	1.67	1.67	0.33	0.33	0.33
Upstream Filter(I)	1.00	0.00	1.00	1.00	0.00	1.00	0.20	0.20	0.20	0.70	0.70	0.00
Uniform Delay (d), s/veh	38.9	0.0	15.6	47.5	0.0	31.4	21.7	14.4	14.4	31.5	37.6	0.0
Incr Delay (d2), s/veh	11.1	0.0	0.2	1.2	0.0	0.0	1.1	1.7	1.7	0.0	2.7	0.0
Initial Q Delay(d3),s/veh	0.0	0.0	0.0	0.0	0.0	0.0	0.0	0.0	0.0	0.0	0.0	0.0
%ile BackOfQ(50%),veh/ln	6.3	0.0	3.9	0.4	0.0	0.2	6.7	5.0	5.1	0.1	10.3	0.0
Unsig. Movement Delay, s/veh												
LnGrp Delay(d),s/veh	50.0	0.0	15.8	48.7	0.0	31.4	22.7	16.2	16.1	31.5	40.3	0.0
LnGrp LOS	D	A	B	D	A	C	C	B	B	C	D	
Approach Vol, veh/h		806			27			1911			815	A
Approach Delay, s/veh		25.8			42.9			19.3			40.2	
Approach LOS		C			D			B			D	
Timer - Assigned Phs	1	2		4	5	6		8				
Phs Duration (G+Y+Rc), s	34.3	37.7		23.0	31.1	40.9		23.0				
Change Period (Y+Rc), s	5.0	5.0		5.0	5.0	5.0		5.0				
Max Green Setting (Gmax), s	45.0	17.0		18.0	7.0	55.0		18.0				
Max Q Clear Time (g_c+Q), s	25.8	24.4		20.0	2.4	21.3		20.0				
Green Ext Time (p_c), s	3.6	0.0		0.0	0.0	14.7		0.0				

Intersection Summary

HCM 6th Ctrl Delay	25.7
HCM 6th LOS	C

Notes

User approved pedestrian interval to be less than phase max green.

Unsignalized Delay for [SBR] is excluded from calculations of the approach delay and intersection delay.

HCM Signalized Intersection Capacity Analysis

10: I-5 SB Ramps & SW Elligsen Road

06/24/2021



Movement	EBL	EBT	EBR	WBL	WBT	WBR	NBL	NBT	NBR	SBL	SBT	SBR
Lane Configurations		↑↑	↗		↑↑	↗				↘	↖	↗
Traffic Volume (vph)	0	960	359	0	741	121	0	0	0	540	0	1015
Future Volume (vph)	0	960	359	0	741	121	0	0	0	540	0	1015
Ideal Flow (vphpl)	1900	1900	1900	1900	1900	1900	1900	1900	1900	1900	1900	1900
Lane Width	12	12	12	12	12	12	12	12	12	12	12	16
Total Lost time (s)		4.0	4.0		4.0	4.0				4.0	4.0	4.0
Lane Util. Factor		0.95	1.00		0.95	1.00				0.95	0.95	1.00
Frbp, ped/bikes		1.00	0.99		1.00	1.00				1.00	1.00	1.00
Flpb, ped/bikes		1.00	1.00		1.00	1.00				1.00	1.00	1.00
Frt		1.00	0.85		1.00	0.85				1.00	1.00	0.85
Flt Protected		1.00	1.00		1.00	1.00				0.95	0.95	1.00
Satd. Flow (prot)		3034	1340		3406	1524				1573	1573	1679
Flt Permitted		1.00	1.00		1.00	1.00				0.95	0.95	1.00
Satd. Flow (perm)		3034	1340		3406	1524				1573	1573	1679
Peak-hour factor, PHF	0.94	0.94	0.94	0.94	0.94	0.94	0.94	0.94	0.94	0.94	0.94	0.94
Adj. Flow (vph)	0	1021	382	0	788	129	0	0	0	574	0	1080
RTOR Reduction (vph)	0	0	0	0	0	0	0	0	0	0	0	8
Lane Group Flow (vph)	0	1021	382	0	788	129	0	0	0	287	287	1072
Confl. Peds. (#/hr)			2									
Heavy Vehicles (%)	19%	19%	19%	6%	6%	6%	0%	0%	0%	9%	9%	9%
Turn Type		NA	Free		NA	Free				Split	NA	custom
Protected Phases		2			6					4	4	5
Permitted Phases			Free		6	Free						4
Actuated Green, G (s)		64.5	95.0		21.7	95.0				21.0	21.0	59.3
Effective Green, g (s)		65.5	95.0		22.7	95.0				21.5	21.5	60.3
Actuated g/C Ratio		0.69	1.00		0.24	1.00				0.23	0.23	0.63
Clearance Time (s)		5.0			5.0					4.5	4.5	4.5
Vehicle Extension (s)		4.1			4.1					2.3	2.3	2.3
Lane Grp Cap (vph)		2091	1340		813	1524				355	355	1136
v/s Ratio Prot		0.34			c0.23					0.18	0.18	c0.39
v/s Ratio Perm			0.29			0.08						0.25
v/c Ratio		0.49	0.29		0.97	0.08				0.81	0.81	0.94
Uniform Delay, d1		6.9	0.0		35.8	0.0				34.8	34.8	15.8
Progression Factor		2.26	1.00		0.62	1.00				1.00	1.00	1.00
Incremental Delay, d2		0.6	0.4		23.2	0.1				12.2	12.2	14.9
Delay (s)		16.2	0.4		45.2	0.1				47.0	47.0	30.7
Level of Service		B	A		D	A				D	D	C
Approach Delay (s)		11.9			38.9			0.0			36.4	
Approach LOS		B			D			A			D	
Intersection Summary												
HCM 2000 Control Delay			28.3									HCM 2000 Level of Service C
HCM 2000 Volume to Capacity ratio			1.00									
Actuated Cycle Length (s)			95.0							12.0		
Intersection Capacity Utilization			90.0%									ICU Level of Service E
Analysis Period (min)			15									
c Critical Lane Group												

V/C Ratio calculated using HCM worksheet with correct lost time

HCM 6th Signalized Intersection Summary
 11: I-5 NB Ramps & SW Elligsen Road

06/24/2021

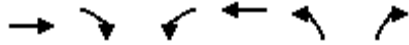

Movement	EBT	EBR	WBL	WBT	NBL	NBR
Lane Configurations	↑↑	↑		↑↑	↑↑	↑
Traffic Volume (veh/h)	764	737	0	335	526	265
Future Volume (veh/h)	764	737	0	335	526	265
Initial Q (Qb), veh	0	0	0	0	0	0
Ped-Bike Adj(A_pbT)		1.00	1.00		1.00	1.00
Parking Bus, Adj	1.00	1.00	1.00	1.00	1.00	1.00
Work Zone On Approach	No			No	No	
Adj Sat Flow, veh/h/ln	1707	1707	0	1796	1811	1811
Adj Flow Rate, veh/h	840	0	0	368	578	0
Peak Hour Factor	0.91	0.91	0.91	0.91	0.91	0.91
Percent Heavy Veh, %	13	13	0	7	6	6
Cap, veh/h	2319		0	2439	673	
Arrive On Green	0.24	0.00	0.00	0.71	0.20	0.00
Sat Flow, veh/h	3329	1447	0	3593	3346	1535
Grp Volume(v), veh/h	840	0	0	368	578	0
Grp Sat Flow(s),veh/h/ln	1622	1447	0	1706	1673	1535
Q Serve(g_s), s	20.6	0.0	0.0	3.3	15.8	0.0
Cycle Q Clear(g_c), s	20.6	0.0	0.0	3.3	15.8	0.0
Prop In Lane		1.00	0.00		1.00	1.00
Lane Grp Cap(c), veh/h	2319		0	2439	673	
V/C Ratio(X)	0.36		0.00	0.15	0.86	
Avail Cap(c_a), veh/h	2319		0	2439	810	
HCM Platoon Ratio	0.33	0.33	1.00	1.00	1.00	1.00
Upstream Filter(I)	0.81	0.00	0.00	1.00	1.00	0.00
Uniform Delay (d), s/veh	18.2	0.0	0.0	4.3	36.7	0.0
Incr Delay (d2), s/veh	0.4	0.0	0.0	0.1	7.4	0.0
Initial Q Delay(d3),s/veh	0.0	0.0	0.0	0.0	0.0	0.0
%ile BackOfQ(50%),veh/ln	8.9	0.0	0.0	1.0	7.0	0.0
Unsig. Movement Delay, s/veh						
LnGrp Delay(d),s/veh	18.6	0.0	0.0	4.5	44.0	0.0
LnGrp LOS	B		A	A	D	
Approach Vol, veh/h	840	A		368	578	A
Approach Delay, s/veh	18.6			4.5	44.0	
Approach LOS	B			A	D	
Timer - Assigned Phs		2			6	8
Phs Duration (G+Y+Rc), s		71.9			71.9	23.1
Change Period (Y+Rc), s		5.0			5.0	4.5
Max Green Setting (Gmax), s		63.0			63.0	22.5
Max Q Clear Time (g_c+I1), s		22.6			5.3	17.8
Green Ext Time (p_c), s		10.4			3.9	0.8

Intersection Summary

HCM 6th Ctrl Delay	23.9
HCM 6th LOS	C

Notes

Unsignalized Delay for [NBR, EBR] is excluded from calculations of the approach delay and intersection delay.

Intersection						
Int Delay, s/veh	1.8					
Movement	EBL	EBT	WBT	WBR	SBL	SBR
Lane Configurations		↕	↕		↕	
Traffic Vol, veh/h	14	110	148	2	19	26
Future Vol, veh/h	14	110	148	2	19	26
Conflicting Peds, #/hr	1	0	0	2	2	1
Sign Control	Free	Free	Free	Free	Stop	Stop
RT Channelized	-	None	-	None	-	None
Storage Length	-	-	-	-	-	-
Veh in Median Storage, #	-	0	0	-	0	-
Grade, %	-	0	0	-	0	-
Peak Hour Factor	80	80	80	80	80	80
Heavy Vehicles, %	0	0	2	2	0	0
Mvmt Flow	18	138	185	3	24	33

Major/Minor	Major1	Major2	Minor2		
Conflicting Flow All	190	0	-	0	365 190
Stage 1	-	-	-	-	189 -
Stage 2	-	-	-	-	176 -
Critical Hdwy	4.1	-	-	-	6.4 6.2
Critical Hdwy Stg 1	-	-	-	-	5.4 -
Critical Hdwy Stg 2	-	-	-	-	5.4 -
Follow-up Hdwy	2.2	-	-	-	3.5 3.3
Pot Cap-1 Maneuver	1396	-	-	-	639 857
Stage 1	-	-	-	-	848 -
Stage 2	-	-	-	-	859 -
Platoon blocked, %		-	-	-	
Mov Cap-1 Maneuver	1393	-	-	-	627 855
Mov Cap-2 Maneuver	-	-	-	-	627 -
Stage 1	-	-	-	-	834 -
Stage 2	-	-	-	-	857 -

Approach	EB	WB	SB
HCM Control Delay, s	0.9	0	10.3
HCM LOS			B

Minor Lane/Major Mvmt	EBL	EBT	WBT	WBR	SBLn1
Capacity (veh/h)	1393	-	-	-	741
HCM Lane V/C Ratio	0.013	-	-	-	0.076
HCM Control Delay (s)	7.6	0	-	-	10.3
HCM Lane LOS	A	A	-	-	B
HCM 95th %tile Q(veh)	0	-	-	-	0.2

HCM 6th TWSC
 13: SW Norwood Road & SW Vermillion Drive

06/24/2021

Intersection						
Int Delay, s/veh	3.2					
Movement	EBL	EBT	WBT	WBR	SBL	SBR
Lane Configurations		↶	↷		↶	
Traffic Vol, veh/h	21	107	105	7	40	45
Future Vol, veh/h	21	107	105	7	40	45
Conflicting Peds, #/hr	0	0	0	0	0	0
Sign Control	Free	Free	Free	Free	Stop	Stop
RT Channelized	-	None	-	None	-	None
Storage Length	-	-	-	-	-	-
Veh in Median Storage, #	-	0	0	-	0	-
Grade, %	-	0	0	-	0	-
Peak Hour Factor	81	81	81	81	81	81
Heavy Vehicles, %	0	0	3	3	0	0
Mvmt Flow	26	132	130	9	49	56

Major/Minor	Major1	Major2	Minor2		
Conflicting Flow All	139	0	-	0	319
Stage 1	-	-	-	-	135
Stage 2	-	-	-	-	184
Critical Hdwy	4.1	-	-	-	6.4
Critical Hdwy Stg 1	-	-	-	-	5.4
Critical Hdwy Stg 2	-	-	-	-	5.4
Follow-up Hdwy	2.2	-	-	-	3.5
Pot Cap-1 Maneuver	1457	-	-	-	678
Stage 1	-	-	-	-	896
Stage 2	-	-	-	-	852
Platoon blocked, %		-	-	-	
Mov Cap-1 Maneuver	1457	-	-	-	665
Mov Cap-2 Maneuver	-	-	-	-	665
Stage 1	-	-	-	-	879
Stage 2	-	-	-	-	852

Approach	EB	WB	SB
HCM Control Delay, s	1.2	0	10.3
HCM LOS			B

Minor Lane/Major Mvmt	EBL	EBT	WBT	WBR	SBLn1
Capacity (veh/h)	1457	-	-	-	779
HCM Lane V/C Ratio	0.018	-	-	-	0.135
HCM Control Delay (s)	7.5	0	-	-	10.3
HCM Lane LOS	A	A	-	-	B
HCM 95th %tile Q(veh)	0.1	-	-	-	0.5

HCM 6th TWSC
 14: SW 82nd Avenue & SW Norwood Road/Driveway

06/24/2021

Intersection												
Int Delay, s/veh	7.3											
Movement	EBL	EBT	EBR	WBL	WBT	WBR	NBL	NBT	NBR	SBL	SBT	SBR
Lane Configurations		↕			↕			↕			↕	↕
Traffic Vol, veh/h	122	0	25	0	0	0	37	4	0	0	0	75
Future Vol, veh/h	122	0	25	0	0	0	37	4	0	0	0	75
Conflicting Peds, #/hr	0	0	0	0	0	0	0	0	0	0	0	0
Sign Control	Free	Free	Free	Free	Free	Free	Stop	Stop	Stop	Stop	Stop	Stop
RT Channelized	-	-	None	-	-	None	-	-	None	-	-	Free
Storage Length	-	-	-	-	-	-	-	-	-	-	-	15
Veh in Median Storage, #	-	0	-	-	0	-	-	0	-	-	0	-
Grade, %	-	0	-	-	0	-	-	0	-	-	0	-
Peak Hour Factor	89	89	89	89	89	89	89	89	89	89	89	89
Heavy Vehicles, %	2	2	2	0	0	0	6	6	6	10	10	10
Mvmt Flow	137	0	28	0	0	0	42	4	0	0	0	84

Major/Minor	Major1			Major2			Minor1			Minor2		
Conflicting Flow All	1	0	0	28	0	0	289	289	14	291	303	-
Stage 1	-	-	-	-	-	-	288	288	-	1	1	-
Stage 2	-	-	-	-	-	-	1	1	-	290	302	-
Critical Hdwy	4.12	-	-	4.1	-	-	7.16	6.56	6.26	7.2	6.6	-
Critical Hdwy Stg 1	-	-	-	-	-	-	6.16	5.56	-	6.2	5.6	-
Critical Hdwy Stg 2	-	-	-	-	-	-	6.16	5.56	-	6.2	5.6	-
Follow-up Hdwy	2.218	-	-	2.2	-	-	3.554	4.054	3.354	3.59	4.09	-
Pot Cap-1 Maneuver	1622	-	-	1599	-	-	655	614	1054	646	597	0
Stage 1	-	-	-	-	-	-	711	666	-	1002	879	0
Stage 2	-	-	-	-	-	-	1012	887	-	701	650	0
Platoon blocked, %	-	-	-	-	-	-	-	-	-	-	-	-
Mov Cap-1 Maneuver	1622	-	-	1599	-	-	612	561	1054	600	546	-
Mov Cap-2 Maneuver	-	-	-	-	-	-	612	561	-	600	546	-
Stage 1	-	-	-	-	-	-	650	609	-	916	879	-
Stage 2	-	-	-	-	-	-	1012	887	-	636	594	-

Approach	EB			WB			NB			SB		
HCM Control Delay, s	6.2			0			11.4			0		
HCM LOS							B			A		

Minor Lane/Major Mvmt	NBLn1	EBL	EBT	EBR	WBL	WBT	WBR	SBLn1	SBLn2
Capacity (veh/h)	607	1622	-	-	1599	-	-	-	-
HCM Lane V/C Ratio	0.076	0.085	-	-	-	-	-	-	-
HCM Control Delay (s)	11.4	7.4	0	-	0	-	-	0	0
HCM Lane LOS	B	A	A	-	A	-	-	A	A
HCM 95th %tile Q(veh)	0.2	0.3	-	-	0	-	-	-	-

HCM 6th TWSC
 15: SW 65th Avenue & SW Norwood Road

06/24/2021

Intersection						
Int Delay, s/veh	5.2					
Movement	EBL	EBR	NBL	NBT	SBT	SBR
Lane Configurations	T			T		
Traffic Vol, veh/h	134	52	40	351	244	62
Future Vol, veh/h	134	52	40	351	244	62
Conflicting Peds, #/hr	2	2	2	0	0	2
Sign Control	Stop	Stop	Free	Free	Free	Free
RT Channelized	-	None	-	None	-	None
Storage Length	-	-	-	-	-	-
Veh in Median Storage, #	0	-	-	0	0	-
Grade, %	0	-	-	0	0	-
Peak Hour Factor	90	90	90	90	90	90
Heavy Vehicles, %	2	2	2	2	6	6
Mvmt Flow	149	58	44	390	271	69

Major/Minor	Minor2	Major1	Major2			
Conflicting Flow All	788	310	342	0	-	0
Stage 1	308	-	-	-	-	-
Stage 2	480	-	-	-	-	-
Critical Hdwy	6.42	6.22	4.12	-	-	-
Critical Hdwy Stg 1	5.42	-	-	-	-	-
Critical Hdwy Stg 2	5.42	-	-	-	-	-
Follow-up Hdwy	3.518	3.318	2.218	-	-	-
Pot Cap-1 Maneuver	360	730	1217	-	-	-
Stage 1	745	-	-	-	-	-
Stage 2	622	-	-	-	-	-
Platoon blocked, %				-	-	-
Mov Cap-1 Maneuver	342	727	1215	-	-	-
Mov Cap-2 Maneuver	342	-	-	-	-	-
Stage 1	709	-	-	-	-	-
Stage 2	621	-	-	-	-	-

Approach	EB	NB	SB
HCM Control Delay, s	23.1	0.8	0
HCM LOS	C		

Minor Lane/Major Mvmt	NBL	NBT	EBLn1	SBT	SBR
Capacity (veh/h)	1215	-	401	-	-
HCM Lane V/C Ratio	0.037	-	0.515	-	-
HCM Control Delay (s)	8.1	0	23.1	-	-
HCM Lane LOS	A	A	C	-	-
HCM 95th %tile Q(veh)	0.1	-	2.9	-	-

HCM 6th Signalized Intersection Summary
 1: SW Boones Ferry Rd & SW Sagert St

06/24/2021



Movement	EBL	EBT	EBR	WBL	WBT	WBR	NBL	NBT	NBR	SBL	SBT	SBR
Lane Configurations												
Traffic Volume (veh/h)	56	173	10	227	98	43	22	386	305	90	666	61
Future Volume (veh/h)	56	173	10	227	98	43	22	386	305	90	666	61
Initial Q (Qb), veh	0	0	0	0	0	0	0	0	0	0	0	0
Ped-Bike Adj(A_pbT)	0.99		0.99	1.00		1.00	1.00		0.98	1.00		0.98
Parking Bus, Adj	1.00	1.00	1.00	1.00	1.00	1.00	1.00	1.00	1.00	1.00	1.00	1.00
Work Zone On Approach		No			No			No			No	
Adj Sat Flow, veh/h/ln	1885	1885	1885	1900	1900	1900	1885	1885	1885	1885	1885	1885
Adj Flow Rate, veh/h	62	190	11	249	108	31	24	424	308	99	732	29
Peak Hour Factor	0.91	0.91	0.91	0.91	0.91	0.91	0.91	0.91	0.91	0.91	0.91	0.91
Percent Heavy Veh, %	1	1	1	0	0	0	1	1	1	1	1	1
Cap, veh/h	344	243	14	347	301	86	293	501	364	277	991	820
Arrive On Green	0.05	0.14	0.13	0.12	0.21	0.21	0.03	0.50	0.49	0.06	0.53	0.53
Sat Flow, veh/h	1795	1764	102	1810	1418	407	1795	1004	729	1795	1885	1560
Grp Volume(v), veh/h	62	0	201	249	0	139	24	0	732	99	732	29
Grp Sat Flow(s),veh/h/ln	1795	0	1866	1810	0	1824	1795	0	1733	1795	1885	1560
Q Serve(g_s), s	2.6	0.0	9.2	10.1	0.0	5.7	0.6	0.0	32.4	2.3	26.6	0.8
Cycle Q Clear(g_c), s	2.6	0.0	9.2	10.1	0.0	5.7	0.6	0.0	32.4	2.3	26.6	0.8
Prop In Lane	1.00		0.05	1.00		0.22	1.00		0.42	1.00		1.00
Lane Grp Cap(c), veh/h	344	0	257	347	0	387	293	0	865	277	991	820
V/C Ratio(X)	0.18	0.00	0.78	0.72	0.00	0.36	0.08	0.00	0.85	0.36	0.74	0.04
Avail Cap(c_a), veh/h	478	0	338	347	0	387	461	0	1099	398	1196	990
HCM Platoon Ratio	1.00	1.00	1.00	1.00	1.00	1.00	1.00	1.00	1.00	1.00	1.00	1.00
Upstream Filter(I)	1.00	0.00	1.00	1.00	0.00	1.00	1.00	0.00	1.00	1.00	1.00	1.00
Uniform Delay (d), s/veh	30.2	0.0	36.8	27.1	0.0	29.7	13.6	0.0	19.4	16.3	16.2	10.1
Incr Delay (d2), s/veh	0.1	0.0	6.0	6.0	0.0	0.2	0.0	0.0	6.1	0.3	2.6	0.0
Initial Q Delay(d3),s/veh	0.0	0.0	0.0	0.0	0.0	0.0	0.0	0.0	0.0	0.0	0.0	0.0
%ile BackOfQ(50%),veh/ln	1.1	0.0	4.5	4.8	0.0	2.5	0.2	0.0	13.5	0.9	11.2	0.3
Unsig. Movement Delay, s/veh												
LnGrp Delay(d),s/veh	30.3	0.0	42.8	33.1	0.0	29.9	13.6	0.0	25.4	16.6	18.8	10.1
LnGrp LOS	C	A	D	C	A	C	B	A	C	B	B	B
Approach Vol, veh/h		263			388			756			860	
Approach Delay, s/veh		39.9			32.0			25.1			18.3	
Approach LOS		D			C			C			B	
Timer - Assigned Phs	1	2	3	4	5	6	7	8				
Phs Duration (G+Y+Rc), s	9.1	48.1	15.0	16.2	6.7	50.4	8.4	22.7				
Change Period (Y+Rc), s	4.5	5.0	4.5	4.5	4.5	5.0	4.5	4.5				
Max Green Setting (Gmax), s	10.5	55.0	10.5	15.5	10.5	55.0	10.5	15.5				
Max Q Clear Time (g_c+I1), s	4.3	34.4	12.1	11.2	2.6	28.6	4.6	7.7				
Green Ext Time (p_c), s	0.1	8.7	0.0	0.3	0.0	9.7	0.0	0.2				

Intersection Summary

HCM 6th Ctrl Delay	25.4
HCM 6th LOS	C

Notes

User approved pedestrian interval to be less than phase max green.

HCM 6th Signalized Intersection Summary

2: SW Boones Ferry Rd & SW Avery St

06/24/2021



Movement	EBL	EBT	EBR	WBL	WBT	WBR	NBL	NBT	NBR	SBL	SBT	SBR
Lane Configurations												
Traffic Volume (veh/h)	257	131	276	53	45	9	119	446	44	14	784	106
Future Volume (veh/h)	257	131	276	53	45	9	119	446	44	14	784	106
Initial Q (Qb), veh	0	0	0	0	0	0	0	0	0	0	0	0
Ped-Bike Adj(A_pbT)	0.99		0.97	1.00		0.99	1.00		0.98	1.00		0.98
Parking Bus, Adj	1.00	1.00	1.00	1.00	1.00	1.00	1.00	1.00	1.00	1.00	1.00	1.00
Work Zone On Approach		No		No		No		No		No		No
Adj Sat Flow, veh/h/ln	1841	1841	1841	1870	1870	1870	1811	1811	1811	1870	1870	1870
Adj Flow Rate, veh/h	268	136	215	55	47	4	124	465	41	15	817	100
Peak Hour Factor	0.96	0.96	0.96	0.96	0.96	0.96	0.96	0.96	0.96	0.96	0.96	0.96
Percent Heavy Veh, %	4	4	4	2	2	2	6	6	6	2	2	2
Cap, veh/h	435	144	228	137	198	17	190	943	83	445	887	109
Arrive On Green	0.15	0.23	0.22	0.04	0.12	0.11	0.05	0.58	0.56	0.02	0.54	0.54
Sat Flow, veh/h	1753	629	994	1781	1697	144	1725	1637	144	1781	1629	199
Grp Volume(v), veh/h	268	0	351	55	0	51	124	0	506	15	0	917
Grp Sat Flow(s),veh/h/ln	1753	0	1623	1781	0	1842	1725	0	1781	1781	0	1829
Q Serve(g_s), s	14.8	0.0	24.1	3.1	0.0	2.9	3.6	0.0	19.1	0.4	0.0	52.0
Cycle Q Clear(g_c), s	14.8	0.0	24.1	3.1	0.0	2.9	3.6	0.0	19.1	0.4	0.0	52.0
Prop In Lane	1.00		0.61	1.00		0.08	1.00		0.08	1.00		0.11
Lane Grp Cap(c), veh/h	435	0	372	137	0	215	190	0	1026	445	0	996
V/C Ratio(X)	0.62	0.00	0.94	0.40	0.00	0.24	0.65	0.00	0.49	0.03	0.00	0.92
Avail Cap(c_a), veh/h	497	0	372	165	0	215	198	0	1036	510	0	1064
HCM Platoon Ratio	1.00	1.00	1.00	1.00	1.00	1.00	1.00	1.00	1.00	1.00	1.00	1.00
Upstream Filter(I)	1.00	0.00	1.00	1.00	0.00	1.00	1.00	0.00	1.00	1.00	0.00	1.00
Uniform Delay (d), s/veh	35.3	0.0	43.3	43.4	0.0	45.6	25.5	0.0	14.3	12.8	0.0	23.6
Incr Delay (d2), s/veh	1.0	0.0	32.1	0.7	0.0	0.2	5.4	0.0	0.5	0.0	0.0	12.5
Initial Q Delay(d3),s/veh	0.0	0.0	0.0	0.0	0.0	0.0	0.0	0.0	0.0	0.0	0.0	0.0
%ile BackOfQ(50%),veh/ln	6.4	0.0	12.9	1.4	0.0	1.3	2.1	0.0	7.6	0.2	0.0	24.6
Unsig. Movement Delay, s/veh												
LnGrp Delay(d),s/veh	36.3	0.0	75.4	44.1	0.0	45.8	30.9	0.0	14.8	12.8	0.0	36.1
LnGrp LOS	D	A	E	D	A	D	C	A	B	B	A	D
Approach Vol, veh/h		619			106			630			932	
Approach Delay, s/veh		58.5			44.9			18.0			35.8	
Approach LOS		E			D			B			D	
Timer - Assigned Phs	1	2	3	4	5	6	7	8				
Phs Duration (G+Y+Rc), s	5.9	69.4	8.2	30.0	9.5	65.8	21.0	17.2				
Change Period (Y+Rc), s	4.0	5.5	4.0	5.0	4.0	5.5	4.0	5.0				
Max Green Setting (Gmax), s	6.0	64.5	6.0	25.0	6.0	64.5	21.0	10.0				
Max Q Clear Time (g_c+1/2), s	12.4	21.1	5.1	26.1	5.6	54.0	16.8	4.9				
Green Ext Time (p_c), s	0.0	5.6	0.0	0.0	0.0	6.3	0.1	0.0				

Intersection Summary

HCM 6th Ctrl Delay	37.4
HCM 6th LOS	D

Notes

User approved pedestrian interval to be less than phase max green.

HCM 6th Signalized Intersection Summary
 3: SW Boones Ferry Road & SW Ibach Street/SW Ibach Court

06/24/2021



Movement	EBL	EBT	EBR	WBL	WBT	WBR	NBL	NBT	NBR	SBL	SBT	SBR
Lane Configurations												
Traffic Volume (veh/h)	165	0	165	3	1	6	201	438	2	12	810	290
Future Volume (veh/h)	165	0	165	3	1	6	201	438	2	12	810	290
Initial Q (Qb), veh	0	0	0	0	0	0	0	0	0	0	0	0
Ped-Bike Adj(A_pbT)	0.95		0.98	0.98		0.95	1.00		0.99	1.00		0.99
Parking Bus, Adj	1.00	1.00	1.00	1.00	1.00	1.00	1.00	1.00	1.00	1.00	1.00	1.00
Work Zone On Approach		No			No			No			No	
Adj Sat Flow, veh/h/ln	1885	1885	1885	1900	1900	1900	1841	1841	1841	1870	1870	1870
Adj Flow Rate, veh/h	172	0	68	3	1	6	209	456	2	12	844	245
Peak Hour Factor	0.96	0.96	0.96	0.96	0.96	0.96	0.96	0.96	0.96	0.96	0.96	0.96
Percent Heavy Veh, %	1	1	1	0	0	0	4	4	4	2	2	2
Cap, veh/h	311	0	257	107	51	152	234	1209	5	21	1007	847
Arrive On Green	0.16	0.00	0.16	0.16	0.16	0.16	0.13	0.66	0.66	0.01	0.54	0.54
Sat Flow, veh/h	1348	0	1559	307	310	925	1753	1831	8	1781	1870	1573
Grp Volume(v), veh/h	172	0	68	10	0	0	209	0	458	12	844	245
Grp Sat Flow(s),veh/h/ln	1348	0	1559	1542	0	0	1753	0	1839	1781	1870	1573
Q Serve(g_s), s	9.5	0.0	3.1	0.0	0.0	0.0	9.7	0.0	9.3	0.6	31.3	7.0
Cycle Q Clear(g_c), s	10.0	0.0	3.1	0.4	0.0	0.0	9.7	0.0	9.3	0.6	31.3	7.0
Prop In Lane	1.00		1.00	0.30		0.60	1.00		0.00	1.00		1.00
Lane Grp Cap(c), veh/h	311	0	257	311	0	0	234	0	1214	21	1007	847
V/C Ratio(X)	0.55	0.00	0.27	0.03	0.00	0.00	0.89	0.00	0.38	0.58	0.84	0.29
Avail Cap(c_a), veh/h	506	0	482	526	0	0	234	0	1226	237	1247	1049
HCM Platoon Ratio	1.00	1.00	1.00	1.00	1.00	1.00	1.00	1.00	1.00	1.00	1.00	1.00
Upstream Filter(l)	1.00	0.00	1.00	1.00	0.00	0.00	1.00	0.00	1.00	1.00	1.00	1.00
Uniform Delay (d), s/veh	32.9	0.0	30.1	29.0	0.0	0.0	35.2	0.0	6.3	40.6	16.0	10.4
Incr Delay (d2), s/veh	0.9	0.0	0.3	0.0	0.0	0.0	31.8	0.0	0.3	14.5	5.0	0.3
Initial Q Delay(d3),s/veh	0.0	0.0	0.0	0.0	0.0	0.0	0.0	0.0	0.0	0.0	0.0	0.0
%ile BackOfQ(50%),veh/ln	3.3	0.0	1.2	0.2	0.0	0.0	6.0	0.0	3.0	0.3	12.9	2.2
Unsig. Movement Delay, s/veh												
LnGrp Delay(d),s/veh	33.8	0.0	30.4	29.0	0.0	0.0	67.0	0.0	6.7	55.1	21.0	10.7
LnGrp LOS	C	A	C	C	A	A	E	A	A	E	C	B
Approach Vol, veh/h		240			10			667			1101	
Approach Delay, s/veh		32.9			29.0			25.6			19.1	
Approach LOS		C			C			C			B	
Timer - Assigned Phs	1	2		4	5	6		8				
Phs Duration (G+Y+Rc), s	5.0	59.5		18.1	15.0	49.4		18.1				
Change Period (Y+Rc), s	4.0	5.0		4.5	4.0	5.0		4.5				
Max Green Setting (Gmax), s	1.0	55.0		25.5	11.0	55.0		25.5				
Max Q Clear Time (g_c+1/2g), s	12.6	11.3		12.0	11.7	33.3		2.4				
Green Ext Time (p_c), s	0.0	5.2		0.5	0.0	11.1		0.0				

Intersection Summary

HCM 6th Ctrl Delay	22.9
HCM 6th LOS	C

HCM 6th TWSC
4: SW Boones Ferry Road & SW Iowa Drive

06/24/2021

Intersection												
Int Delay, s/veh	5.6											
Movement	EBL	EBT	EBR	WBL	WBT	WBR	NBL	NBT	NBR	SBL	SBT	SBR
Lane Configurations		↕			↕		↕	↕		↕	↕	
Traffic Vol, veh/h	37	0	35	13	1	39	34	537	30	36	803	51
Future Vol, veh/h	37	0	35	13	1	39	34	537	30	36	803	51
Conflicting Peds, #/hr	0	0	4	4	0	0	4	0	4	0	0	0
Sign Control	Stop	Stop	Stop	Stop	Stop	Stop	Free	Free	Free	Free	Free	Free
RT Channelized	-	-	None	-	-	None	-	-	None	-	-	None
Storage Length	-	-	-	-	-	-	95	-	-	105	-	-
Veh in Median Storage, #	-	0	-	-	0	-	-	0	-	-	0	-
Grade, %	-	0	-	-	0	-	-	0	-	-	0	-
Peak Hour Factor	94	94	94	94	94	94	94	94	94	94	94	94
Heavy Vehicles, %	5	5	5	2	2	2	3	3	3	1	1	1
Mvmt Flow	39	0	37	14	1	41	36	571	32	38	854	54

Major/Minor	Minor2		Minor1		Major1			Major2				
Conflicting Flow All	1641	1640	889	1643	1651	591	912	0	0	607	0	0
Stage 1	961	961	-	663	663	-	-	-	-	-	-	-
Stage 2	680	679	-	980	988	-	-	-	-	-	-	-
Critical Hdwy	7.15	6.55	6.25	7.12	6.52	6.22	4.13	-	-	4.11	-	-
Critical Hdwy Stg 1	6.15	5.55	-	6.12	5.52	-	-	-	-	-	-	-
Critical Hdwy Stg 2	6.15	5.55	-	6.12	5.52	-	-	-	-	-	-	-
Follow-up Hdwy	3.545	4.045	3.345	3.518	4.018	3.318	2.227	-	-	2.209	-	-
Pot Cap-1 Maneuver	79	99	338	80	99	507	743	-	-	976	-	-
Stage 1	304	331	-	450	459	-	-	-	-	-	-	-
Stage 2	436	447	-	301	325	-	-	-	-	-	-	-
Platoon blocked, %								-	-	-	-	-
Mov Cap-1 Maneuver	67	90	335	66	90	505	740	-	-	972	-	-
Mov Cap-2 Maneuver	67	90	-	66	90	-	-	-	-	-	-	-
Stage 1	288	317	-	427	435	-	-	-	-	-	-	-
Stage 2	380	423	-	256	311	-	-	-	-	-	-	-

Approach	EB		WB		NB			SB		
HCM Control Delay, s	91.6		32.6		0.6			0.4		
HCM LOS	F		D							

Minor Lane/Major Mvmt	NBL	NBT	NBR	EBLn1	WBLn1	SBL	SBT	SBR
Capacity (veh/h)	740	-	-	110	186	972	-	-
HCM Lane V/C Ratio	0.049	-	-	0.696	0.303	0.039	-	-
HCM Control Delay (s)	10.1	-	-	91.6	32.6	8.9	-	-
HCM Lane LOS	B	-	-	F	D	A	-	-
HCM 95th %tile Q(veh)	0.2	-	-	3.7	1.2	0.1	-	-

HCM 6th TWSC
5: SW Boones Ferry Road & SW Norwood Road

06/24/2021

Intersection						
Int Delay, s/veh	2.1					
Movement	WBL	WBR	NBT	NBR	SBL	SBT
Lane Configurations	↔		↑	↔	↔	↑
Traffic Vol, veh/h	46	79	522	102	92	759
Future Vol, veh/h	46	79	522	102	92	759
Conflicting Peds, #/hr	2	2	0	2	2	0
Sign Control	Stop	Stop	Free	Free	Free	Free
RT Channelized	-	None	-	None	-	None
Storage Length	-	-	-	65	290	-
Veh in Median Storage, #	0	-	0	-	-	0
Grade, %	0	-	0	-	-	0
Peak Hour Factor	95	95	95	95	95	95
Heavy Vehicles, %	2	2	3	3	2	2
Mvmt Flow	48	83	549	107	97	799

Major/Minor	Minor1	Major1	Major2		
Conflicting Flow All	1546	553	0	0	658
Stage 1	551	-	-	-	-
Stage 2	995	-	-	-	-
Critical Hdwy	6.42	6.22	-	-	4.12
Critical Hdwy Stg 1	5.42	-	-	-	-
Critical Hdwy Stg 2	5.42	-	-	-	-
Follow-up Hdwy	3.518	3.318	-	-	2.218
Pot Cap-1 Maneuver	126	533	-	-	930
Stage 1	577	-	-	-	-
Stage 2	358	-	-	-	-
Platoon blocked, %			-	-	-
Mov Cap-1 Maneuver	112	531	-	-	928
Mov Cap-2 Maneuver	233	-	-	-	-
Stage 1	576	-	-	-	-
Stage 2	320	-	-	-	-

Approach	WB	NB	SB
HCM Control Delay, s	20.6	0	1
HCM LOS	C		

Minor Lane/Major Mvmt	NBT	NBRWBLn1	SBL	SBT
Capacity (veh/h)	-	-	361	928
HCM Lane V/C Ratio	-	-	0.364	0.104
HCM Control Delay (s)	-	-	20.6	9.3
HCM Lane LOS	-	-	C	A
HCM 95th %tile Q(veh)	-	-	1.6	0.3

Intersection						
Int Delay, s/veh	0					
Movement	WBL	WBR	NBT	NBR	SBL	SBT
Lane Configurations						
Traffic Vol, veh/h	0	0	621	2	1	810
Future Vol, veh/h	0	0	621	2	1	810
Conflicting Peds, #/hr	2	2	0	2	2	0
Sign Control	Stop	Stop	Free	Free	Free	Free
RT Channelized	-	None	-	None	-	None
Storage Length	-	-	-	-	150	-
Veh in Median Storage, #	2	-	0	-	-	0
Grade, %	0	-	0	-	-	0
Peak Hour Factor	95	95	95	95	95	95
Heavy Vehicles, %	0	0	3	3	2	2
Mvmt Flow	0	0	654	2	1	853

Major/Minor	Minor1	Major1	Major2		
Conflicting Flow All	1514	659	0	0	658
Stage 1	657	-	-	-	-
Stage 2	857	-	-	-	-
Critical Hdwy	6.4	6.2	-	-	4.12
Critical Hdwy Stg 1	5.4	-	-	-	-
Critical Hdwy Stg 2	5.4	-	-	-	-
Follow-up Hdwy	3.5	3.3	-	-	2.218
Pot Cap-1 Maneuver	133	467	-	-	930
Stage 1	519	-	-	-	-
Stage 2	419	-	-	-	-
Platoon blocked, %			-	-	-
Mov Cap-1 Maneuver	132	465	-	-	928
Mov Cap-2 Maneuver	332	-	-	-	-
Stage 1	518	-	-	-	-
Stage 2	418	-	-	-	-

Approach	WB	NB	SB
HCM Control Delay, s	0	0	0
HCM LOS	A		

Minor Lane/Major Mvmt	NBT	NBRWBLn1	SBL	SBT
Capacity (veh/h)	-	-	928	-
HCM Lane V/C Ratio	-	-	0.001	-
HCM Control Delay (s)	-	-	0	8.9
HCM Lane LOS	-	-	A	A
HCM 95th %tile Q(veh)	-	-	-	0

HCM 6th Signalized Intersection Summary

8: SW Boones Ferry Road & SW Day Road

06/24/2021



Movement	EBL	EBT	EBR	WBL	WBT	WBR	NBL	NBT	NBR	SBL	SBT	SBR
Lane Configurations		↖	↗		↔		↖↗	↖		↖	↕	↗
Traffic Volume (veh/h)	6	0	811	0	0	0	664	615	0	0	737	72
Future Volume (veh/h)	6	0	811	0	0	0	664	615	0	0	737	72
Initial Q (Qb), veh	0	0	0	0	0	0	0	0	0	0	0	0
Ped-Bike Adj(A_pbT)	1.00		1.00	1.00		1.00	1.00		1.00	1.00		1.00
Parking Bus, Adj	1.00	1.00	1.00	1.00	1.00	1.00	1.00	1.00	1.00	1.00	1.00	1.00
Work Zone On Approach		No			No			No			No	
Adj Sat Flow, veh/h/ln	1870	1870	1870	1900	1900	1900	1856	1856	1856	1885	1885	1885
Adj Flow Rate, veh/h	6	0	777	0	0	0	678	628	0	0	752	68
Peak Hour Factor	0.98	0.98	0.98	0.98	0.98	0.98	0.98	0.98	0.98	0.98	0.98	0.98
Percent Heavy Veh, %	2	2	2	0	0	0	3	3	3	1	1	1
Cap, veh/h	271	0	665	0	271	0	758	715	0	609	1577	143
Arrive On Green	0.14	0.00	0.15	0.00	0.00	0.00	0.45	0.64	0.00	0.00	0.47	0.46
Sat Flow, veh/h	1418	0	1585	0	1900	0	2827	1856	0	1795	3322	300
Grp Volume(v), veh/h	6	0	777	0	0	0	678	628	0	0	405	415
Grp Sat Flow(s),veh/h/ln	1418	0	1585	0	1900	0	1414	1856	0	1795	1791	1831
Q Serve(g_s), s	0.4	0.0	15.9	0.0	0.0	0.0	23.2	29.1	0.0	0.0	16.1	16.2
Cycle Q Clear(g_c), s	0.4	0.0	15.9	0.0	0.0	0.0	23.2	29.1	0.0	0.0	16.1	16.2
Prop In Lane	1.00		1.00	0.00		0.00	1.00		0.00	1.00		0.16
Lane Grp Cap(c), veh/h	264	0	665	0	271	0	758	715	0	609	850	869
V/C Ratio(X)	0.02	0.00	1.17	0.00	0.00	0.00	0.89	0.88	0.00	0.00	0.48	0.48
Avail Cap(c_a), veh/h	264	0	665	0	271	0	1158	1219	0	609	850	869
HCM Platoon Ratio	1.00	1.00	1.00	1.00	1.00	1.00	1.67	1.67	1.67	1.00	1.00	1.00
Upstream Filter(I)	1.00	0.00	1.00	0.00	0.00	0.00	0.91	0.91	0.00	0.00	1.00	1.00
Uniform Delay (d), s/veh	39.0	0.0	30.5	0.0	0.0	0.0	27.6	16.7	0.0	0.0	18.7	18.8
Incr Delay (d2), s/veh	0.0	0.0	91.3	0.0	0.0	0.0	4.7	13.3	0.0	0.0	1.9	1.9
Initial Q Delay(d3),s/veh	0.0	0.0	0.0	0.0	0.0	0.0	0.0	0.0	0.0	0.0	0.0	0.0
%ile BackOfQ(50%),veh/ln	0.1	0.0	32.4	0.0	0.0	0.0	6.7	10.1	0.0	0.0	6.6	6.8
Unsig. Movement Delay, s/veh												
LnGrp Delay(d),s/veh	39.0	0.0	121.8	0.0	0.0	0.0	32.3	29.9	0.0	0.0	20.6	20.7
LnGrp LOS	D	A	F	A	A	A	C	C	A	A	C	C
Approach Vol, veh/h		783			0			1306			820	
Approach Delay, s/veh		121.1			0.0			31.2			20.7	
Approach LOS		F						C			C	
Timer - Assigned Phs	1	2		4	5	6		8				
Phs Duration (G+Y+Rc), s	32.2	53.8		19.0	41.5	44.5		19.0				
Change Period (Y+Rc), s	* 5.4	* 5.4		4.5	* 5.4	* 5.4		4.5				
Max Green Setting (Gmax), s	* 42	* 34		14.5	* 8.5	* 68		14.5				
Max Q Clear Time (g_c+I1), s	25.2	18.2		0.0	0.0	31.1		17.9				
Green Ext Time (p_c), s	1.6	6.4		0.0	0.0	8.0		0.0				

Intersection Summary

HCM 6th Ctrl Delay	52.4
HCM 6th LOS	D

Notes

User approved pedestrian interval to be less than phase max green.

* HCM 6th computational engine requires equal clearance times for the phases crossing the barrier.

HCM 6th Signalized Intersection Summary
 9: SW Boones Ferry Road & SW 95th Avenue

06/24/2021



Movement	EBL	EBT	EBR	WBL	WBT	WBR	NBL	NBT	NBR	SBL	SBT	SBR
Lane Configurations		↕	↗	↖	↗	↖	↗	↖		↖	↗	↖
Traffic Volume (veh/h)	241	1	834	50	18	7	605	935	12	3	1191	245
Future Volume (veh/h)	241	1	834	50	18	7	605	935	12	3	1191	245
Initial Q (Qb), veh	0	0	0	0	0	0	0	0	0	0	0	0
Ped-Bike Adj(A_pbT)	0.99		0.97	1.00		0.99	1.00		1.00	1.00		1.00
Parking Bus, Adj	1.00	1.00	1.00	1.00	1.00	1.00	1.00	1.00	1.00	1.00	1.00	1.00
Work Zone On Approach		No		No		No		No		No		No
Adj Sat Flow, veh/h/ln	1826	1826	1826	1870	1870	1870	1781	1781	1781	1856	1856	1856
Adj Flow Rate, veh/h	251	1	869	52	19	7	630	974	12	3	1241	0
Peak Hour Factor	0.96	0.96	0.96	0.96	0.96	0.96	0.96	0.96	0.96	0.96	0.96	0.96
Percent Heavy Veh, %	5	5	5	2	2	2	8	8	8	3	3	3
Cap, veh/h	281	1	1053	75	223	82	727	1241	15	622	1740	
Arrive On Green	0.16	0.17	0.17	0.17	0.17	0.17	0.44	0.73	0.71	0.70	0.99	0.00
Sat Flow, veh/h	1239	5	2634	636	1302	480	3291	3424	42	1767	3526	1572
Grp Volume(v), veh/h	252	0	869	52	0	26	630	481	505	3	1241	0
Grp Sat Flow(s),veh/h/ln	1244	0	1317	636	0	1781	1646	1692	1774	1767	1763	1572
Q Serve(g_s), s	15.7	0.0	18.0	1.0	0.0	1.3	18.2	19.0	19.1	0.1	1.6	0.0
Cycle Q Clear(g_c), s	17.0	0.0	18.0	18.0	0.0	1.3	18.2	19.0	19.1	0.1	1.6	0.0
Prop In Lane	1.00		1.00	1.00		0.27	1.00		0.02	1.00		1.00
Lane Grp Cap(c), veh/h	270	0	1053	75	0	305	727	614	643	622	1740	
V/C Ratio(X)	0.93	0.00	0.83	0.70	0.00	0.09	0.87	0.78	0.78	0.00	0.71	
Avail Cap(c_a), veh/h	270	0	1053	75	0	305	1066	1048	1098	622	1740	
HCM Platoon Ratio	1.00	1.00	1.00	1.00	1.00	1.00	2.00	2.00	2.00	2.00	2.00	2.00
Upstream Filter(I)	1.00	0.00	1.00	1.00	0.00	1.00	0.59	0.59	0.59	0.55	0.55	0.00
Uniform Delay (d), s/veh	45.8	0.0	28.9	52.4	0.0	36.6	27.9	11.8	11.8	10.1	0.4	0.0
Incr Delay (d2), s/veh	37.2	0.0	5.3	23.2	0.0	0.1	3.2	5.9	5.7	0.0	1.4	0.0
Initial Q Delay(d3),s/veh	0.0	0.0	0.0	0.0	0.0	0.0	0.0	0.0	0.0	0.0	0.0	0.0
%ile BackOfQ(50%),veh/ln	0.5	0.0	10.3	1.8	0.0	0.6	5.5	4.7	4.9	0.0	0.5	0.0
Unsig. Movement Delay, s/veh												
LnGrp Delay(d),s/veh	83.0	0.0	34.2	75.7	0.0	36.7	31.1	17.8	17.5	10.1	1.8	0.0
LnGrp LOS	F	A	C	E	A	D	C	B	B	B	A	
Approach Vol, veh/h		1121			78			1616			1244	A
Approach Delay, s/veh		45.2			62.7			22.9			1.8	
Approach LOS		D			E			C			A	
Timer - Assigned Phs	1	2		4	5	6		8				
Phs Duration (G+Y+Rc), s	27.2	55.8		22.0	40.9	42.1		22.0				
Change Period (Y+Rc), s	5.0	5.0		5.0	5.0	5.0		5.0				
Max Green Setting (Gmax), s	33.0	40.0		17.0	9.0	64.0		17.0				
Max Q Clear Time (g_c+20), s	20.2	3.6		20.0	2.1	21.1		20.0				
Green Ext Time (p_c), s	2.0	11.6		0.0	0.0	16.0		0.0				

Intersection Summary

HCM 6th Ctrl Delay	23.3
HCM 6th LOS	C

Notes

User approved pedestrian interval to be less than phase max green.
 Unsignalized Delay for [SBR] is excluded from calculations of the approach delay and intersection delay.

HCM Signalized Intersection Capacity Analysis
 10: I-5 SB Ramps & SW Boones Ferry Road/SW Elligsen Road

06/23/2021



Movement	EBL	EBT	EBR	WBL	WBT	WBR	NBL	NBT	NBR	SBL	SBT	SBR
Lane Configurations		↑↑	↗		↑↑	↗				↘	↖	↗
Traffic Volume (vph)	0	1134	940	0	713	389	0	0	0	597	91	838
Future Volume (vph)	0	1134	940	0	713	389	0	0	0	597	91	838
Ideal Flow (vphpl)	1900	1900	1900	1900	1900	1900	1900	1900	1900	1900	1900	1900
Lane Width	12	12	12	12	12	12	12	12	12	12	12	16
Total Lost time (s)		4.0	4.0		4.0	3.0				4.0	4.0	4.0
Lane Util. Factor		0.95	1.00		0.95	1.00				0.95	0.95	1.00
Fr _t		1.00	0.85		1.00	0.85				1.00	1.00	0.85
Fl _t Protected		1.00	1.00		1.00	1.00				0.95	0.96	1.00
Satd. Flow (prot)		3505	1568		3505	1568				1603	1627	1711
Fl _t Permitted		1.00	1.00		1.00	1.00				0.95	0.96	1.00
Satd. Flow (perm)		3505	1568		3505	1568				1603	1627	1711
Peak-hour factor, PHF	0.97	0.97	0.97	0.97	0.97	0.97	0.97	0.97	0.97	0.97	0.97	0.97
Adj. Flow (vph)	0	1169	969	0	735	401	0	0	0	615	94	864
RTOR Reduction (vph)	0	0	0	0	0	0	0	0	0	0	0	54
Lane Group Flow (vph)	0	1169	969	0	735	401	0	0	0	351	358	810
Heavy Vehicles (%)	3%	3%	3%	3%	3%	3%	0%	0%	0%	7%	7%	7%
Turn Type		NA	Free		NA	Free				Split	NA	custom
Protected Phases		2			6					4	4	5
Permitted Phases			Free		6	Free						4
Actuated Green, G (s)		67.6	105.0		43.4	105.0				27.9	27.9	47.6
Effective Green, g (s)		68.6	105.0		44.4	105.0				28.4	28.4	48.6
Actuated g/C Ratio		0.65	1.00		0.42	1.00				0.27	0.27	0.46
Clearance Time (s)		5.0			5.0					4.5	4.5	4.5
Vehicle Extension (s)		4.1			4.1					2.3	2.3	2.3
Lane Grp Cap (vph)		2289	1568		1482	1568				433	440	857
v/s Ratio Prot		0.33			0.21					0.22	0.22	c0.18
v/s Ratio Perm			c0.62			0.26						0.29
v/c Ratio		0.51	0.62		0.50	0.26				0.81	0.81	0.94
Uniform Delay, d ₁		9.5	0.0		22.1	0.0				35.8	35.8	26.9
Progression Factor		0.90	1.00		1.07	1.00				1.00	1.00	1.00
Incremental Delay, d ₂		0.5	1.2		1.1	0.4				10.6	10.6	18.5
Delay (s)		9.1	1.2		24.8	0.4				46.4	46.4	45.4
Level of Service		A	A		C	A				D	D	D
Approach Delay (s)		5.5			16.2			0.0			45.9	
Approach LOS		A			B			A			D	
Intersection Summary												
HCM 2000 Control Delay			21.1									HCM 2000 Level of Service C
HCM 2000 Volume to Capacity ratio			0.86									
Actuated Cycle Length (s)			105.0							12.0		Sum of lost time (s)
Intersection Capacity Utilization			78.3%									ICU Level of Service D
Analysis Period (min)			15									

c Critical Lane Group

V/C Ratio calculated using HCM worksheet with correct critical movements and lost time

HCM 6th Signalized Intersection Summary
 11: I-5 NB Ramps & SW Elligsen Road

06/24/2021

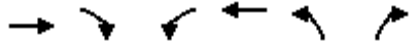

Movement	EBT	EBR	WBL	WBT	NBL	NBR
Lane Configurations	↑↑	↑		↑↑	↑↑	↑
Traffic Volume (veh/h)	1013	721	0	775	329	245
Future Volume (veh/h)	1013	721	0	775	329	245
Initial Q (Qb), veh	0	0	0	0	0	0
Ped-Bike Adj(A_pbT)		1.00	1.00		1.00	1.00
Parking Bus, Adj	1.00	1.00	1.00	1.00	1.00	1.00
Work Zone On Approach	No			No	No	
Adj Sat Flow, veh/h/ln	1841	1841	0	1885	1841	1841
Adj Flow Rate, veh/h	1113	0	0	852	362	0
Peak Hour Factor	0.91	0.91	0.91	0.91	0.91	0.91
Percent Heavy Veh, %	4	4	0	1	4	4
Cap, veh/h	2759		0	2826	458	
Arrive On Green	1.00	0.00	0.00	0.79	0.13	0.00
Sat Flow, veh/h	3589	1560	0	3770	3401	1560
Grp Volume(v), veh/h	1113	0	0	852	362	0
Grp Sat Flow(s),veh/h/ln	1749	1560	0	1791	1700	1560
Q Serve(g_s), s	0.0	0.0	0.0	6.9	10.8	0.0
Cycle Q Clear(g_c), s	0.0	0.0	0.0	6.9	10.8	0.0
Prop In Lane		1.00	0.00		1.00	1.00
Lane Grp Cap(c), veh/h	2759		0	2826	458	
V/C Ratio(X)	0.40		0.00	0.30	0.79	
Avail Cap(c_a), veh/h	2759		0	2826	1166	
HCM Platoon Ratio	2.00	2.00	1.00	1.00	1.00	1.00
Upstream Filter(l)	0.79	0.00	0.00	1.00	1.00	0.00
Uniform Delay (d), s/veh	0.0	0.0	0.0	3.1	44.0	0.0
Incr Delay (d2), s/veh	0.3	0.0	0.0	0.3	1.9	0.0
Initial Q Delay(d3),s/veh	0.0	0.0	0.0	0.0	0.0	0.0
%ile BackOfQ(50%),veh/ln	0.1	0.0	0.0	1.8	4.6	0.0
Unsig. Movement Delay, s/veh						
LnGrp Delay(d),s/veh	0.3	0.0	0.0	3.3	45.9	0.0
LnGrp LOS	A		A	A	D	
Approach Vol, veh/h	1113	A		852	362	A
Approach Delay, s/veh	0.3			3.3	45.9	
Approach LOS	A			A	D	
Timer - Assigned Phs		2			6	8
Phs Duration (G+Y+Rc), s		86.8			86.8	18.2
Change Period (Y+Rc), s		5.0			5.0	4.5
Max Green Setting (Gmax), s		60.0			60.0	35.5
Max Q Clear Time (g_c+I1), s		2.0			8.9	12.8
Green Ext Time (p_c), s		16.8			11.0	0.8

Intersection Summary

HCM 6th Ctrl Delay	8.5
HCM 6th LOS	A

Notes

Unsignalized Delay for [NBR, EBR] is excluded from calculations of the approach delay and intersection delay.

HCM 6th TWSC
 12: SW Norwood Road & SW 89th Avenue

06/24/2021

Intersection

Int Delay, s/veh 1.1

Movement	EBL	EBT	WBT	WBR	SBL	SBR
Lane Configurations		↕	↕		↕	
Traffic Vol, veh/h	33	200	150	14	11	9
Future Vol, veh/h	33	200	150	14	11	9
Conflicting Peds, #/hr	2	0	0	2	2	2
Sign Control	Free	Free	Free	Free	Stop	Stop
RT Channelized	-	None	-	None	-	None
Storage Length	-	-	-	-	-	-
Veh in Median Storage, #	-	0	0	-	0	-
Grade, %	-	0	0	-	0	-
Peak Hour Factor	92	92	92	92	92	92
Heavy Vehicles, %	1	1	0	0	0	0
Mvmt Flow	36	217	163	15	12	10

Major/Minor	Major1	Major2	Minor2
Conflicting Flow All	180	0	464
Stage 1	-	-	173
Stage 2	-	-	291
Critical Hdwy	4.11	-	6.4
Critical Hdwy Stg 1	-	-	5.4
Critical Hdwy Stg 2	-	-	5.4
Follow-up Hdwy	2.209	-	3.5
Pot Cap-1 Maneuver	1402	-	560
Stage 1	-	-	862
Stage 2	-	-	763
Platoon blocked, %	-	-	-
Mov Cap-1 Maneuver	1399	-	542
Mov Cap-2 Maneuver	-	-	542
Stage 1	-	-	835
Stage 2	-	-	761

Approach	EB	WB	SB
HCM Control Delay, s	1.1	0	10.7
HCM LOS			B

Minor Lane/Major Mvmt	EBL	EBT	WBT	WBR	SBLn1
Capacity (veh/h)	1399	-	-	-	653
HCM Lane V/C Ratio	0.026	-	-	-	0.033
HCM Control Delay (s)	7.6	0	-	-	10.7
HCM Lane LOS	A	A	-	-	B
HCM 95th %tile Q(veh)	0.1	-	-	-	0.1

HCM 6th TWSC
 13: SW Norwood Road & SW Vermillion Drive

06/24/2021

Intersection						
Int Delay, s/veh	2.9					
Movement	EBL	EBT	WBT	WBR	SBL	SBR
Lane Configurations		↕	↕		↕	
Traffic Vol, veh/h	70	141	127	39	24	37
Future Vol, veh/h	70	141	127	39	24	37
Conflicting Peds, #/hr	0	0	0	0	0	0
Sign Control	Free	Free	Free	Free	Stop	Stop
RT Channelized	-	None	-	None	-	None
Storage Length	-	-	-	-	-	-
Veh in Median Storage, #	-	0	0	-	0	-
Grade, %	-	0	0	-	0	-
Peak Hour Factor	72	72	72	72	72	72
Heavy Vehicles, %	1	1	0	0	0	0
Mvmt Flow	97	196	176	54	33	51

Major/Minor	Major1	Major2	Minor2		
Conflicting Flow All	230	0	-	0	593
Stage 1	-	-	-	-	203
Stage 2	-	-	-	-	390
Critical Hdwy	4.11	-	-	-	6.4
Critical Hdwy Stg 1	-	-	-	-	5.4
Critical Hdwy Stg 2	-	-	-	-	5.4
Follow-up Hdwy	2.209	-	-	-	3.5
Pot Cap-1 Maneuver	1344	-	-	-	472
Stage 1	-	-	-	-	836
Stage 2	-	-	-	-	689
Platoon blocked, %		-	-	-	
Mov Cap-1 Maneuver	1344	-	-	-	434
Mov Cap-2 Maneuver	-	-	-	-	434
Stage 1	-	-	-	-	768
Stage 2	-	-	-	-	689

Approach	EB	WB	SB
HCM Control Delay, s	2.6	0	11.8
HCM LOS			B

Minor Lane/Major Mvmt	EBL	EBT	WBT	WBR	SBLn1
Capacity (veh/h)	1344	-	-	-	615
HCM Lane V/C Ratio	0.072	-	-	-	0.138
HCM Control Delay (s)	7.9	0	-	-	11.8
HCM Lane LOS	A	A	-	-	B
HCM 95th %tile Q(veh)	0.2	-	-	-	0.5

HCM 6th TWSC
 14: SW 82nd Avenue & SW Norwood Road/Driveway

06/24/2021

Intersection												
Int Delay, s/veh	6.9											
Movement	EBL	EBT	EBR	WBL	WBT	WBR	NBL	NBT	NBR	SBL	SBT	SBR
Lane Configurations		↕			↕			↕			↕	↕
Traffic Vol, veh/h	130	0	35	0	0	1	21	8	0	2	4	145
Future Vol, veh/h	130	0	35	0	0	1	21	8	0	2	4	145
Conflicting Peds, #/hr	0	0	0	0	0	0	0	0	0	0	0	0
Sign Control	Free	Free	Free	Free	Free	Free	Stop	Stop	Stop	Stop	Stop	Stop
RT Channelized	-	-	None	-	-	None	-	-	None	-	-	Free
Storage Length	-	-	-	-	-	-	-	-	-	-	-	15
Veh in Median Storage, #	-	0	-	-	0	-	-	0	-	-	0	-
Grade, %	-	0	-	-	0	-	-	0	-	-	0	-
Peak Hour Factor	83	83	83	83	83	83	83	83	83	83	83	83
Heavy Vehicles, %	0	0	0	0	0	0	0	0	0	0	0	0
Mvmt Flow	157	0	42	0	0	1	25	10	0	2	5	175

Major/Minor	Major1			Major2			Minor1			Minor2		
Conflicting Flow All	1	0	0	42	0	0	338	336	21	341	357	-
Stage 1	-	-	-	-	-	-	335	335	-	1	1	-
Stage 2	-	-	-	-	-	-	3	1	-	340	356	-
Critical Hdwy	4.1	-	-	4.1	-	-	7.1	6.5	6.2	7.1	6.5	-
Critical Hdwy Stg 1	-	-	-	-	-	-	6.1	5.5	-	6.1	5.5	-
Critical Hdwy Stg 2	-	-	-	-	-	-	6.1	5.5	-	6.1	5.5	-
Follow-up Hdwy	2.2	-	-	2.2	-	-	3.5	4	3.3	3.5	4	-
Pot Cap-1 Maneuver	1635	-	-	1580	-	-	620	588	1062	617	572	0
Stage 1	-	-	-	-	-	-	683	646	-	1027	899	0
Stage 2	-	-	-	-	-	-	1025	899	-	679	633	0
Platoon blocked, %	-	-	-	-	-	-	-	-	-	-	-	-
Mov Cap-1 Maneuver	1635	-	-	1580	-	-	569	530	1062	563	515	-
Mov Cap-2 Maneuver	-	-	-	-	-	-	569	530	-	563	515	-
Stage 1	-	-	-	-	-	-	615	582	-	925	899	-
Stage 2	-	-	-	-	-	-	1020	899	-	602	570	-

Approach	EB			WB			NB			SB		
HCM Control Delay, s	5.9			0			11.9			11.9		
HCM LOS							B			B		

Minor Lane/Major Mvmt	NBLn1	EBL	EBT	EBR	WBL	WBT	WBR	SBLn1	SBLn2
Capacity (veh/h)	558	1635	-	-	1580	-	-	530	-
HCM Lane V/C Ratio	0.063	0.096	-	-	-	-	-	0.014	-
HCM Control Delay (s)	11.9	7.4	0	-	0	-	-	11.9	0
HCM Lane LOS	B	A	A	-	A	-	-	B	A
HCM 95th %tile Q(veh)	0.2	0.3	-	-	0	-	-	0	-

HCM 6th TWSC
 15: SW 65th Avenue & SW Norwood Road

06/24/2021

Intersection						
Int Delay, s/veh	3.5					
Movement	EBL	EBR	NBL	NBT	SBT	SBR
Lane Configurations	T			T		
Traffic Vol, veh/h	69	65	58	227	403	116
Future Vol, veh/h	69	65	58	227	403	116
Conflicting Peds, #/hr	0	0	0	0	0	0
Sign Control	Stop	Stop	Free	Free	Free	Free
RT Channelized	-	None	-	None	-	None
Storage Length	-	-	-	-	-	-
Veh in Median Storage, #	0	-	-	0	0	-
Grade, %	0	-	-	0	0	-
Peak Hour Factor	89	89	89	89	89	89
Heavy Vehicles, %	0	0	2	2	0	0
Mvmt Flow	78	73	65	255	453	130

Major/Minor	Minor2	Major1		Major2	
Conflicting Flow All	903	518	583	0	0
Stage 1	518	-	-	-	-
Stage 2	385	-	-	-	-
Critical Hdwy	6.4	6.2	4.12	-	-
Critical Hdwy Stg 1	5.4	-	-	-	-
Critical Hdwy Stg 2	5.4	-	-	-	-
Follow-up Hdwy	3.5	3.3	2.218	-	-
Pot Cap-1 Maneuver	310	562	991	-	-
Stage 1	602	-	-	-	-
Stage 2	692	-	-	-	-
Platoon blocked, %				-	-
Mov Cap-1 Maneuver	286	562	991	-	-
Mov Cap-2 Maneuver	286	-	-	-	-
Stage 1	556	-	-	-	-
Stage 2	692	-	-	-	-

Approach	EB	NB	SB
HCM Control Delay, s	20.9	1.8	0
HCM LOS	C		

Minor Lane/Major Mvmt	NBL	NBT	EBLn1	SBT	SBR
Capacity (veh/h)	991	-	375	-	-
HCM Lane V/C Ratio	0.066	-	0.401	-	-
HCM Control Delay (s)	8.9	0	20.9	-	-
HCM Lane LOS	A	A	C	-	-
HCM 95th %tile Q(veh)	0.2	-	1.9	-	-

HCM 6th Signalized Intersection Summary

1: SW Boones Ferry Rd & SW Sagert St

08/31/2021



Movement	EBL	EBT	EBR	WBL	WBT	WBR	NBL	NBT	NBR	SBL	SBT	SBR
Lane Configurations												
Traffic Volume (veh/h)	70	77	12	179	99	60	7	596	285	51	271	47
Future Volume (veh/h)	70	77	12	179	99	60	7	596	285	51	271	47
Initial Q (Qb), veh	0	0	0	0	0	0	0	0	0	0	0	0
Ped-Bike Adj(A_pbT)	1.00		0.99	1.00		1.00	1.00		0.98	1.00		0.98
Parking Bus, Adj	1.00	1.00	1.00	1.00	1.00	1.00	1.00	1.00	1.00	1.00	1.00	1.00
Work Zone On Approach		No			No			No			No	
Adj Sat Flow, veh/h/ln	1885	1885	1885	1900	1900	1900	1885	1885	1885	1811	1811	1811
Adj Flow Rate, veh/h	77	85	8	197	109	44	8	655	297	56	298	30
Peak Hour Factor	0.91	0.91	0.91	0.91	0.91	0.91	0.91	0.91	0.91	0.91	0.91	0.91
Percent Heavy Veh, %	1	1	1	0	0	0	1	1	1	6	6	6
Cap, veh/h	258	135	13	334	181	73	668	708	321	209	1110	919
Arrive On Green	0.06	0.08	0.07	0.12	0.14	0.14	0.02	0.58	0.57	0.05	0.61	0.61
Sat Flow, veh/h	1795	1696	160	1810	1285	519	1795	1218	552	1725	1811	1501
Grp Volume(v), veh/h	77	0	93	197	0	153	8	0	952	56	298	30
Grp Sat Flow(s),veh/h/ln	1795	0	1855	1810	0	1804	1795	0	1771	1725	1811	1501
Q Serve(g_s), s	3.6	0.0	4.5	8.8	0.0	7.4	0.2	0.0	45.0	1.1	7.1	0.7
Cycle Q Clear(g_c), s	3.6	0.0	4.5	8.8	0.0	7.4	0.2	0.0	45.0	1.1	7.1	0.7
Prop In Lane	1.00		0.09	1.00		0.29	1.00		0.31	1.00		1.00
Lane Grp Cap(c), veh/h	258	0	148	334	0	255	668	0	1030	209	1110	919
V/C Ratio(X)	0.30	0.00	0.63	0.59	0.00	0.60	0.01	0.00	0.92	0.27	0.27	0.03
Avail Cap(c_a), veh/h	368	0	321	334	0	312	854	0	1073	334	1110	919
HCM Platoon Ratio	1.00	1.00	1.00	1.00	1.00	1.00	1.00	1.00	1.00	1.00	1.00	1.00
Upstream Filter(l)	1.00	0.00	1.00	1.00	0.00	1.00	1.00	0.00	1.00	1.00	1.00	1.00
Uniform Delay (d), s/veh	35.9	0.0	41.2	31.8	0.0	37.3	7.8	0.0	17.7	19.1	8.3	7.1
Incr Delay (d2), s/veh	0.2	0.0	1.6	1.9	0.0	0.8	0.0	0.0	13.2	0.3	0.2	0.0
Initial Q Delay(d3),s/veh	0.0	0.0	0.0	0.0	0.0	0.0	0.0	0.0	0.0	0.0	0.0	0.0
%ile BackOfQ(50%),veh/ln	1.6	0.0	2.1	4.0	0.0	3.3	0.1	0.0	20.1	0.6	2.6	0.2
Unsig. Movement Delay, s/veh												
LnGrp Delay(d),s/veh	36.2	0.0	42.9	33.6	0.0	38.2	7.8	0.0	30.9	19.4	8.5	7.1
LnGrp LOS	D	A	D	C	A	D	A	A	C	B	A	A
Approach Vol, veh/h		170			350			960			384	
Approach Delay, s/veh		39.8			35.6			30.7			10.0	
Approach LOS		D			D			C			A	
Timer - Assigned Phs	1	2	3	4	5	6	7	8				
Phs Duration (G+Y+Rc), s	8.3	57.7	15.0	11.4	5.4	60.6	9.3	17.0				
Change Period (Y+Rc), s	4.5	5.0	4.5	4.5	4.5	5.0	4.5	4.5				
Max Green Setting (Gmax), s	10.5	55.0	10.5	15.5	10.5	55.0	10.5	15.5				
Max Q Clear Time (g_c+I1), s	3.1	47.0	10.8	6.5	2.2	9.1	5.6	9.4				
Green Ext Time (p_c), s	0.0	5.7	0.0	0.2	0.0	3.6	0.0	0.2				

Intersection Summary

HCM 6th Ctrl Delay	28.2
HCM 6th LOS	C

Notes

User approved pedestrian interval to be less than phase max green.

HCM 6th Signalized Intersection Summary

2: SW Boones Ferry Rd & SW Avery St

08/31/2021



Movement	EBL	EBT	EBR	WBL	WBT	WBR	NBL	NBT	NBR	SBL	SBT	SBR
Lane Configurations												
Traffic Volume (veh/h)	172	68	144	30	103	15	258	702	40	6	302	154
Future Volume (veh/h)	172	68	144	30	103	15	258	702	40	6	302	154
Initial Q (Qb), veh	0	0	0	0	0	0	0	0	0	0	0	0
Ped-Bike Adj(A_pbT)	1.00		0.97	0.99		0.96	1.00		0.98	1.00		1.00
Parking Bus, Adj	1.00	1.00	1.00	1.00	1.00	1.00	1.00	1.00	1.00	1.00	1.00	1.00
Work Zone On Approach		No			No			No			No	
Adj Sat Flow, veh/h/ln	1841	1841	1841	1841	1841	1841	1767	1767	1767	1841	1841	1841
Adj Flow Rate, veh/h	205	81	100	36	123	12	307	836	42	7	360	165
Peak Hour Factor	0.84	0.84	0.84	0.84	0.84	0.84	0.84	0.84	0.84	0.84	0.84	0.84
Percent Heavy Veh, %	4	4	4	4	4	4	9	9	9	4	4	4
Cap, veh/h	327	146	180	241	177	17	442	967	49	184	623	286
Arrive On Green	0.12	0.20	0.19	0.03	0.11	0.10	0.07	0.58	0.56	0.01	0.52	0.52
Sat Flow, veh/h	1753	736	908	1753	1644	160	1682	1666	84	1753	1193	547
Grp Volume(v), veh/h	205	0	181	36	0	135	307	0	878	7	0	525
Grp Sat Flow(s),veh/h/ln	1753	0	1644	1753	0	1804	1682	0	1749	1753	0	1740
Q Serve(g_s), s	8.9	0.0	8.9	1.6	0.0	6.4	6.0	0.0	37.7	0.2	0.0	18.4
Cycle Q Clear(g_c), s	8.9	0.0	8.9	1.6	0.0	6.4	6.0	0.0	37.7	0.2	0.0	18.4
Prop In Lane	1.00		0.55	1.00		0.09	1.00		0.05	1.00		0.31
Lane Grp Cap(c), veh/h	327	0	326	241	0	194	442	0	1015	184	0	909
V/C Ratio(X)	0.63	0.00	0.56	0.15	0.00	0.69	0.70	0.00	0.86	0.04	0.00	0.58
Avail Cap(c_a), veh/h	524	0	479	301	0	223	442	0	1295	286	0	1288
HCM Platoon Ratio	1.00	1.00	1.00	1.00	1.00	1.00	1.00	1.00	1.00	1.00	1.00	1.00
Upstream Filter(I)	1.00	0.00	1.00	1.00	0.00	1.00	1.00	0.00	1.00	1.00	0.00	1.00
Uniform Delay (d), s/veh	29.5	0.0	32.5	34.5	0.0	38.4	16.2	0.0	15.8	16.6	0.0	14.6
Incr Delay (d2), s/veh	0.7	0.0	0.6	0.1	0.0	5.6	4.0	0.0	5.7	0.0	0.0	0.8
Initial Q Delay(d3),s/veh	0.0	0.0	0.0	0.0	0.0	0.0	0.0	0.0	0.0	0.0	0.0	0.0
%ile BackOfQ(50%),veh/ln	3.7	0.0	3.5	0.7	0.0	3.1	3.2	0.0	14.9	0.1	0.0	6.9
Unsig. Movement Delay, s/veh												
LnGrp Delay(d),s/veh	30.2	0.0	33.0	34.6	0.0	44.0	20.1	0.0	21.5	16.6	0.0	15.4
LnGrp LOS	C	A	C	C	A	D	C	A	C	B	A	B
Approach Vol, veh/h		386			171			1185			532	
Approach Delay, s/veh		31.5			42.0			21.2			15.4	
Approach LOS		C			D			C			B	
Timer - Assigned Phs	1	2	3	4	5	6	7	8				
Phs Duration (G+Y+Rc), s	4.8	55.8	7.0	21.7	10.0	50.6	15.0	13.6				
Change Period (Y+Rc), s	4.0	5.5	4.0	5.0	4.0	5.5	4.0	5.0				
Max Green Setting (Gmax), s	6.0	64.5	6.0	25.0	6.0	64.5	21.0	10.0				
Max Q Clear Time (g_c+1/2), s	11.2	39.7	3.6	10.9	8.0	20.4	10.9	8.4				
Green Ext Time (p_c), s	0.0	10.5	0.0	0.6	0.0	6.1	0.1	0.1				

Intersection Summary

HCM 6th Ctrl Delay	23.2
HCM 6th LOS	C

Notes

User approved pedestrian interval to be less than phase max green.

HCM 6th Signalized Intersection Summary
 3: SW Boones Ferry Road & SW Ibach Street/SW Ibach Court

08/31/2021



Movement	EBL	EBT	EBR	WBL	WBT	WBR	NBL	NBT	NBR	SBL	SBT	SBR
Lane Configurations												
Traffic Volume (veh/h)	252	4	332	4	1	18	133	732	10	3	388	84
Future Volume (veh/h)	252	4	332	4	1	18	133	732	10	3	388	84
Initial Q (Qb), veh	0	0	0	0	0	0	0	0	0	0	0	0
Ped-Bike Adj(A_pbT)	0.98		0.99	1.00		0.97	1.00		0.99	1.00		0.99
Parking Bus, Adj	1.00	1.00	1.00	1.00	1.00	1.00	1.00	1.00	1.00	1.00	1.00	1.00
Work Zone On Approach		No			No			No			No	
Adj Sat Flow, veh/h/ln	1856	1856	1856	1900	1900	1900	1796	1796	1796	1811	1811	1811
Adj Flow Rate, veh/h	290	5	210	5	1	10	153	841	11	3	446	51
Peak Hour Factor	0.87	0.87	0.87	0.87	0.87	0.87	0.87	0.87	0.87	0.87	0.87	0.87
Percent Heavy Veh, %	3	3	3	0	0	0	7	7	7	6	6	6
Cap, veh/h	426	10	432	134	50	207	187	992	13	6	824	694
Arrive On Green	0.28	0.28	0.28	0.28	0.28	0.28	0.11	0.56	0.55	0.00	0.45	0.45
Sat Flow, veh/h	1360	36	1528	262	177	732	1711	1769	23	1725	1811	1526
Grp Volume(v), veh/h	290	0	215	16	0	0	153	0	852	3	446	51
Grp Sat Flow(s),veh/h/ln	1360	0	1564	1170	0	0	1711	0	1792	1725	1811	1526
Q Serve(g_s), s	9.9	0.0	9.0	0.1	0.0	0.0	6.9	0.0	31.2	0.1	14.0	1.5
Cycle Q Clear(g_c), s	18.9	0.0	9.0	9.1	0.0	0.0	6.9	0.0	31.2	0.1	14.0	1.5
Prop In Lane	1.00		0.98	0.31		0.62	1.00		0.01	1.00		1.00
Lane Grp Cap(c), veh/h	426	0	442	384	0	0	187	0	1005	6	824	694
V/C Ratio(X)	0.68	0.00	0.49	0.04	0.00	0.00	0.82	0.00	0.85	0.54	0.54	0.07
Avail Cap(c_a), veh/h	492	0	518	453	0	0	240	0	1278	242	1292	1089
HCM Platoon Ratio	1.00	1.00	1.00	1.00	1.00	1.00	1.00	1.00	1.00	1.00	1.00	1.00
Upstream Filter(I)	1.00	0.00	1.00	1.00	0.00	0.00	1.00	0.00	1.00	1.00	1.00	1.00
Uniform Delay (d), s/veh	27.8	0.0	23.6	20.7	0.0	0.0	34.2	0.0	14.4	39.1	15.5	12.1
Incr Delay (d2), s/veh	2.5	0.0	0.5	0.0	0.0	0.0	13.6	0.0	5.2	41.6	0.9	0.1
Initial Q Delay(d3),s/veh	0.0	0.0	0.0	0.0	0.0	0.0	0.0	0.0	0.0	0.0	0.0	0.0
%ile BackOfQ(50%),veh/ln	5.3	0.0	3.3	0.2	0.0	0.0	3.4	0.0	12.0	0.1	5.4	0.5
Unsig. Movement Delay, s/veh												
LnGrp Delay(d),s/veh	30.4	0.0	24.1	20.7	0.0	0.0	47.8	0.0	19.6	80.6	16.4	12.1
LnGrp LOS	C	A	C	C	A	A	D	A	B	F	B	B
Approach Vol, veh/h		505			16			1005			500	
Approach Delay, s/veh		27.7			20.7			23.9			16.3	
Approach LOS		C			C			C			B	
Timer - Assigned Phs	1	2		4	5	6		8				
Phs Duration (G+Y+Rc), s	4.3	48.0		26.2	12.6	39.7		26.2				
Change Period (Y+Rc), s	4.0	5.0		4.5	4.0	5.0		4.5				
Max Green Setting (Gmax), s	1.0	55.0		25.5	11.0	55.0		25.5				
Max Q Clear Time (g_c+1/2, s)	1.0	33.2		20.9	8.9	16.0		11.1				
Green Ext Time (p_c), s	0.0	9.8		0.8	0.1	5.3		0.0				
Intersection Summary												
HCM 6th Ctrl Delay											23.0	
HCM 6th LOS											C	

HCM 6th TWSC
4: SW Boones Ferry Road & SW Iowa Drive

08/31/2021

Intersection												
Int Delay, s/veh	9.4											
Movement	EBL	EBT	EBR	WBL	WBT	WBR	NBL	NBT	NBR	SBL	SBT	SBR
Lane Configurations		↕			↕		↕	↕		↕	↕	
Traffic Vol, veh/h	49	2	54	29	0	31	14	682	10	19	446	17
Future Vol, veh/h	49	2	54	29	0	31	14	682	10	19	446	17
Conflicting Peds, #/hr	13	0	5	1	0	9	5	0	1	9	0	13
Sign Control	Stop	Stop	Stop	Stop	Stop	Stop	Free	Free	Free	Free	Free	Free
RT Channelized	-	-	None	-	-	None	-	-	None	-	-	None
Storage Length	-	-	-	-	-	-	95	-	-	105	-	-
Veh in Median Storage, #	-	0	-	-	0	-	-	0	-	-	0	-
Grade, %	-	0	-	-	0	-	-	0	-	-	0	-
Peak Hour Factor	84	84	84	84	84	84	84	84	84	84	84	84
Heavy Vehicles, %	0	0	0	0	0	0	7	7	7	6	6	6
Mvmt Flow	58	2	64	35	0	37	17	812	12	23	531	20

Major/Minor	Minor2		Minor1		Major1			Major2				
Conflicting Flow All	1484	1467	559	1486	1471	840	564	0	0	833	0	0
Stage 1	600	600	-	861	861	-	-	-	-	-	-	-
Stage 2	884	867	-	625	610	-	-	-	-	-	-	-
Critical Hdwy	7.1	6.5	6.2	7.1	6.5	6.2	4.17	-	-	4.16	-	-
Critical Hdwy Stg 1	6.1	5.5	-	6.1	5.5	-	-	-	-	-	-	-
Critical Hdwy Stg 2	6.1	5.5	-	6.1	5.5	-	-	-	-	-	-	-
Follow-up Hdwy	3.5	4	3.3	3.5	4	3.3	2.263	-	-	2.254	-	-
Pot Cap-1 Maneuver	104	129	532	104	128	368	983	-	-	783	-	-
Stage 1	491	493	-	353	375	-	-	-	-	-	-	-
Stage 2	343	373	-	476	488	-	-	-	-	-	-	-
Platoon blocked, %								-	-	-	-	-
Mov Cap-1 Maneuver	88	120	523	85	119	360	971	-	-	776	-	-
Mov Cap-2 Maneuver	88	120	-	85	119	-	-	-	-	-	-	-
Stage 1	476	472	-	344	365	-	-	-	-	-	-	-
Stage 2	299	363	-	401	468	-	-	-	-	-	-	-

Approach	EB		WB		NB		SB	
HCM Control Delay, s	86.3		54.9		0.2		0.4	
HCM LOS	F		F					

Minor Lane/Major Mvmt	NBL	NBT	NBR	EBLn1WBLn1	SBL	SBT	SBR
Capacity (veh/h)	971	-	-	155	140	776	-
HCM Lane V/C Ratio	0.017	-	-	0.806	0.51	0.029	-
HCM Control Delay (s)	8.8	-	-	86.3	54.9	9.8	-
HCM Lane LOS	A	-	-	F	F	A	-
HCM 95th %tile Q(veh)	0.1	-	-	5.2	2.4	0.1	-

HCM 6th TWSC
5: SW Boones Ferry Road & SW Norwood Road

08/31/2021

Intersection						
Int Delay, s/veh	6					
Movement	WBL	WBR	NBT	NBR	SBL	SBT
Lane Configurations	↘↘		↑	↑	↘	↑
Traffic Vol, veh/h	112	91	614	43	61	467
Future Vol, veh/h	112	91	614	43	61	467
Conflicting Peds, #/hr	4	4	0	4	4	0
Sign Control	Stop	Stop	Free	Free	Free	Free
RT Channelized	-	None	-	None	-	None
Storage Length	-	-	-	65	290	-
Veh in Median Storage, #	0	-	0	-	-	0
Grade, %	0	-	0	-	-	0
Peak Hour Factor	87	87	87	87	87	87
Heavy Vehicles, %	2	2	6	6	5	5
Mvmt Flow	129	105	706	49	70	537

Major/Minor	Minor1	Major1	Major2		
Conflicting Flow All	1391	714	0	0	759
Stage 1	710	-	-	-	-
Stage 2	681	-	-	-	-
Critical Hdwy	6.42	6.22	-	-	4.15
Critical Hdwy Stg 1	5.42	-	-	-	-
Critical Hdwy Stg 2	5.42	-	-	-	-
Follow-up Hdwy	3.518	3.318	-	-	2.245
Pot Cap-1 Maneuver	157	431	-	-	839
Stage 1	487	-	-	-	-
Stage 2	503	-	-	-	-
Platoon blocked, %			-	-	-
Mov Cap-1 Maneuver	143	428	-	-	836
Mov Cap-2 Maneuver	280	-	-	-	-
Stage 1	485	-	-	-	-
Stage 2	459	-	-	-	-

Approach	WB	NB	SB
HCM Control Delay, s	38.1	0	1.1
HCM LOS	E		

Minor Lane/Major Mvmt	NBT	NBRWBLn1	SBL	SBT
Capacity (veh/h)	-	-	331	836
HCM Lane V/C Ratio	-	-	0.705	0.084
HCM Control Delay (s)	-	-	38.1	9.7
HCM Lane LOS	-	-	E	A
HCM 95th %tile Q(veh)	-	-	5.1	0.3

HCM 6th TWSC
6: SW Boones Ferry Road & Site Access

08/31/2021

Intersection						
Int Delay, s/veh	0					
Movement	WBL	WBR	NBT	NBR	SBL	SBT
Lane Configurations						
Traffic Vol, veh/h	0	0	662	0	0	582
Future Vol, veh/h	0	0	662	0	0	582
Conflicting Peds, #/hr	4	4	0	4	4	0
Sign Control	Stop	Stop	Free	Free	Free	Free
RT Channelized	-	None	-	None	-	None
Storage Length	-	-	-	-	150	-
Veh in Median Storage, #	2	-	0	-	-	0
Grade, %	0	-	0	-	-	0
Peak Hour Factor	87	87	87	87	87	87
Heavy Vehicles, %	0	0	6	6	5	5
Mvmt Flow	0	0	761	0	0	669

Major/Minor	Minor1	Major1	Major2		
Conflicting Flow All	1438	769	0	0	765
Stage 1	765	-	-	-	-
Stage 2	673	-	-	-	-
Critical Hdwy	6.4	6.2	-	-	4.15
Critical Hdwy Stg 1	5.4	-	-	-	-
Critical Hdwy Stg 2	5.4	-	-	-	-
Follow-up Hdwy	3.5	3.3	-	-	2.245
Pot Cap-1 Maneuver	148	404	-	-	835
Stage 1	463	-	-	-	-
Stage 2	511	-	-	-	-
Platoon blocked, %			-	-	-
Mov Cap-1 Maneuver	147	401	-	-	832
Mov Cap-2 Maneuver	352	-	-	-	-
Stage 1	461	-	-	-	-
Stage 2	509	-	-	-	-

Approach	WB	NB	SB
HCM Control Delay, s	0	0	0
HCM LOS	A		

Minor Lane/Major Mvmt	NBT	NBRWBLn1	SBL	SBT
Capacity (veh/h)	-	-	832	-
HCM Lane V/C Ratio	-	-	-	-
HCM Control Delay (s)	-	-	0	0
HCM Lane LOS	-	-	A	A
HCM 95th %tile Q(veh)	-	-	0	0

HCM 6th TWSC
 7: SW Boones Ferry Road & SW Greenhill Lane

08/31/2021

Intersection

Int Delay, s/veh 0

Movement	WBL	WBR	NBT	NBR	SBL	SBT
Lane Configurations						
Traffic Vol, veh/h	2	1	659	0	0	581
Future Vol, veh/h	2	1	659	0	0	581
Conflicting Peds, #/hr	4	4	0	4	4	0
Sign Control	Stop	Stop	Free	Free	Free	Free
RT Channelized	-	None	-	None	-	None
Storage Length	-	-	-	-	150	-
Veh in Median Storage, #	2	-	0	-	-	0
Grade, %	0	-	0	-	-	0
Peak Hour Factor	87	87	87	87	87	87
Heavy Vehicles, %	0	0	6	6	5	5
Mvmt Flow	2	1	757	0	0	668

Major/Minor	Minor1	Major1	Major2		
Conflicting Flow All	1433	765	0	0	761
Stage 1	761	-	-	-	-
Stage 2	672	-	-	-	-
Critical Hdwy	6.4	6.2	-	-	4.15
Critical Hdwy Stg 1	5.4	-	-	-	-
Critical Hdwy Stg 2	5.4	-	-	-	-
Follow-up Hdwy	3.5	3.3	-	-	2.245
Pot Cap-1 Maneuver	149	406	-	-	838
Stage 1	465	-	-	-	-
Stage 2	511	-	-	-	-
Platoon blocked, %			-	-	-
Mov Cap-1 Maneuver	148	403	-	-	835
Mov Cap-2 Maneuver	353	-	-	-	-
Stage 1	463	-	-	-	-
Stage 2	509	-	-	-	-

Approach	WB	NB	SB
HCM Control Delay, s	14.9	0	0
HCM LOS	B		

Minor Lane/Major Mvmt	NBT	NBRWBLn1	SBL	SBT
Capacity (veh/h)	-	-	368	835
HCM Lane V/C Ratio	-	-	0.009	-
HCM Control Delay (s)	-	-	14.9	0
HCM Lane LOS	-	-	B	A
HCM 95th %tile Q(veh)	-	-	0	0

HCM 6th Signalized Intersection Summary
 8: SW Boones Ferry Road & SW Day Road

08/31/2021



Movement	EBL	EBT	EBR	WBL	WBT	WBR	NBL	NBT	NBR	SBL	SBT	SBR
Lane Configurations		↔	↔		↔		↔	↔		↔	↔	
Traffic Volume (veh/h)	175	0	560	0	0	0	619	484	0	0	522	59
Future Volume (veh/h)	175	0	560	0	0	0	619	484	0	0	522	59
Initial Q (Qb), veh	0	0	0	0	0	0	0	0	0	0	0	0
Ped-Bike Adj(A_pbT)	1.00		1.00	1.00		1.00	1.00		1.00	1.00		1.00
Parking Bus, Adj	1.00	1.00	1.00	1.00	1.00	1.00	1.00	1.00	1.00	1.00	1.00	1.00
Work Zone On Approach		No			No			No			No	
Adj Sat Flow, veh/h/ln	1693	1693	1693	1900	1900	1900	1693	1693	1693	1796	1796	1796
Adj Flow Rate, veh/h	194	0	572	0	0	0	688	538	0	0	580	55
Peak Hour Factor	0.90	0.90	0.90	0.90	0.90	0.90	0.90	0.90	0.90	0.90	0.90	0.90
Percent Heavy Veh, %	14	14	14	0	0	0	14	14	14	7	7	7
Cap, veh/h	285	0	653	0	316	0	792	686	0	497	1289	122
Arrive On Green	0.16	0.00	0.17	0.00	0.00	0.00	0.10	0.13	0.00	0.00	0.41	0.39
Sat Flow, veh/h	1283	0	1434	0	1900	0	2740	1693	0	1711	3151	298
Grp Volume(v), veh/h	194	0	572	0	0	0	688	538	0	0	314	321
Grp Sat Flow(s),veh/h/ln	1283	0	1434	0	1900	0	1370	1693	0	1711	1706	1743
Q Serve(g_s), s	14.2	0.0	15.8	0.0	0.0	0.0	23.5	29.2	0.0	0.0	12.6	12.7
Cycle Q Clear(g_c), s	14.2	0.0	15.8	0.0	0.0	0.0	23.5	29.2	0.0	0.0	12.6	12.7
Prop In Lane	1.00		1.00	0.00		0.00	1.00		0.00	1.00		0.17
Lane Grp Cap(c), veh/h	282	0	653	0	316	0	792	686	0	497	698	713
V/C Ratio(X)	0.69	0.00	0.88	0.00	0.00	0.00	0.87	0.78	0.00	0.00	0.45	0.45
Avail Cap(c_a), veh/h	282	0	653	0	320	0	1047	1033	0	497	698	713
HCM Platoon Ratio	1.00	1.00	1.00	1.00	1.00	1.00	0.33	0.33	0.33	1.00	1.00	1.00
Upstream Filter(I)	1.00	0.00	1.00	0.00	0.00	0.00	0.90	0.90	0.00	0.00	1.00	1.00
Uniform Delay (d), s/veh	39.3	0.0	23.4	0.0	0.0	0.0	41.2	37.1	0.0	0.0	20.3	20.4
Incr Delay (d2), s/veh	6.4	0.0	12.6	0.0	0.0	0.0	5.1	8.0	0.0	0.0	2.1	2.1
Initial Q Delay(d3),s/veh	0.0	0.0	0.0	0.0	0.0	0.0	0.0	0.0	0.0	0.0	0.0	0.0
%ile BackOfQ(50%),veh/ln	4.8	0.0	12.8	0.0	0.0	0.0	9.1	14.7	0.0	0.0	5.0	5.2
Unsig. Movement Delay, s/veh												
LnGrp Delay(d),s/veh	45.7	0.0	36.0	0.0	0.0	0.0	46.3	45.1	0.0	0.0	22.4	22.5
LnGrp LOS	D	A	D	A	A	A	D	D	A	A	C	C
Approach Vol, veh/h		766			0			1226			635	
Approach Delay, s/veh		38.5			0.0			45.7			22.5	
Approach LOS		D						D			C	
Timer - Assigned Phs	1	2		4	5	6		8				
Phs Duration (G+Y+Rc), s	32.1	42.9		20.0	32.5	42.5		20.0				
Change Period (Y+Rc), s	5.2	* 5.4		* 4.7	* 5.4	* 5.4		* 4.7				
Max Green Setting (Gmax), s	35.8	* 29		* 16	* 8.5	* 57		* 15				
Max Q Clear Time (g_c+I1), s	25.5	14.7		0.0	0.0	31.2		17.8				
Green Ext Time (p_c), s	1.4	4.6		0.0	0.0	5.9		0.0				

Intersection Summary

HCM 6th Ctrl Delay	38.0
HCM 6th LOS	D

Notes

User approved pedestrian interval to be less than phase max green.
 * HCM 6th computational engine requires equal clearance times for the phases crossing the barrier.

HCM 6th Signalized Intersection Summary
 9: SW Elligsen Road/SW Boones Ferry Road & SW 95th Avenue

08/31/2021



Movement	EBL	EBT	EBR	WBL	WBT	WBR	NBL	NBT	NBR	SBL	SBT	SBR
Lane Configurations		↕	↗	↖	↗	↖	↗	↖		↖	↗	↖
Traffic Volume (veh/h)	200	7	540	16	1	6	815	818	68	5	734	263
Future Volume (veh/h)	200	7	540	16	1	6	815	818	68	5	734	263
Initial Q (Qb), veh	0	0	0	0	0	0	0	0	0	0	0	0
Ped-Bike Adj(A_pbT)	1.00		0.99	1.00		1.00	1.00		1.00	1.00		1.00
Parking Bus, Adj	1.00	1.00	1.00	1.00	1.00	1.00	1.00	1.00	1.00	1.00	1.00	1.00
Work Zone On Approach		No		No		No		No		No		No
Adj Sat Flow, veh/h/ln	1648	1648	1648	1737	1737	1737	1796	1796	1796	1737	1737	1737
Adj Flow Rate, veh/h	217	8	587	17	1	7	886	889	74	5	798	0
Peak Hour Factor	0.92	0.92	0.92	0.92	0.92	0.92	0.92	0.92	0.92	0.92	0.92	0.92
Percent Heavy Veh, %	17	17	17	11	11	11	7	7	7	11	11	11
Cap, veh/h	297	8	1198	80	35	248	992	1179	98	468	1168	
Arrive On Green	0.19	0.19	0.19	0.19	0.19	0.19	0.50	0.62	0.62	0.09	0.12	0.00
Sat Flow, veh/h	1175	43	2445	763	187	1309	3319	3189	265	1654	3300	1472
Grp Volume(v), veh/h	225	0	587	17	0	8	886	476	487	5	798	0
Grp Sat Flow(s),veh/h/ln	1219	0	1223	763	0	1496	1659	1706	1748	1654	1650	1472
Q Serve(g_s), s	17.0	0.0	15.4	0.5	0.0	0.4	22.9	18.9	18.9	0.3	22.0	0.0
Cycle Q Clear(g_c), s	17.5	0.0	15.4	18.0	0.0	0.4	22.9	18.9	18.9	0.3	22.0	0.0
Prop In Lane	0.96		1.00	1.00		0.88	1.00		0.15	1.00		1.00
Lane Grp Cap(c), veh/h	305	0	1198	80	0	284	992	631	646	468	1168	
V/C Ratio(X)	0.74	0.00	0.49	0.21	0.00	0.03	0.89	0.75	0.75	0.01	0.68	
Avail Cap(c_a), veh/h	305	0	1198	80	0	284	1572	988	1012	468	1168	
HCM Platoon Ratio	1.00	1.00	1.00	1.00	1.00	1.00	1.67	1.67	1.67	0.33	0.33	0.33
Upstream Filter(I)	1.00	0.00	1.00	1.00	0.00	1.00	0.27	0.27	0.27	0.72	0.72	0.00
Uniform Delay (d), s/veh	38.5	0.0	16.4	47.4	0.0	31.4	22.4	15.1	15.1	31.0	36.8	0.0
Incr Delay (d2), s/veh	8.6	0.0	0.2	1.0	0.0	0.0	1.3	2.3	2.3	0.0	2.4	0.0
Initial Q Delay(d3),s/veh	0.0	0.0	0.0	0.0	0.0	0.0	0.0	0.0	0.0	0.0	0.0	0.0
%ile BackOfQ(50%),veh/ln	5.8	0.0	4.1	0.4	0.0	0.2	6.6	5.1	5.2	0.1	10.0	0.0
Unsig. Movement Delay, s/veh												
LnGrp Delay(d),s/veh	47.1	0.0	16.6	48.4	0.0	31.4	23.7	17.4	17.3	31.0	39.2	0.0
LnGrp LOS	D	A	B	D	A	C	C	B	B	C	D	
Approach Vol, veh/h		812			25		1849			803	A	
Approach Delay, s/veh		25.0			43.0		20.4			39.1		
Approach LOS		C			D		C			D		
Timer - Assigned Phs	1	2		4	5	6		8				
Phs Duration (G+Y+Rc), s	33.4	38.6		23.0	31.9	40.1		23.0				
Change Period (Y+Rc), s	5.0	5.0		5.0	5.0	5.0		5.0				
Max Green Setting (Gmax), s	45.0	17.0		18.0	7.0	55.0		18.0				
Max Q Clear Time (g_c+Y), s	24.5	24.0		20.0	2.3	20.9		19.5				
Green Ext Time (p_c), s	3.5	0.0		0.0	0.0	14.2		0.0				

Intersection Summary

HCM 6th Ctrl Delay	26.0
HCM 6th LOS	C

Notes

User approved pedestrian interval to be less than phase max green.
 Unsignalized Delay for [SBR] is excluded from calculations of the approach delay and intersection delay.

HCM Signalized Intersection Capacity Analysis
 10: I-5 SB Ramps & SW Elligsen Road

08/31/2021



Movement	EBL	EBT	EBR	WBL	WBT	WBR	NBL	NBT	NBR	SBL	SBT	SBR		
Lane Configurations		↑↑	↗		↑↑	↗				↘	↖	↗		
Traffic Volume (vph)	0	938	351	0	718	117	0	0	0	520	0	980		
Future Volume (vph)	0	938	351	0	718	117	0	0	0	520	0	980		
Ideal Flow (vphpl)	1900	1900	1900	1900	1900	1900	1900	1900	1900	1900	1900	1900		
Lane Width	12	12	12	12	12	12	12	12	12	12	12	16		
Total Lost time (s)		4.0	4.0		4.0	4.0				4.0	4.0	4.0		
Lane Util. Factor		0.95	1.00		0.95	1.00				0.95	0.95	1.00		
Frbp, ped/bikes		1.00	0.99		1.00	1.00				1.00	1.00	1.00		
Flpb, ped/bikes		1.00	1.00		1.00	1.00				1.00	1.00	1.00		
Frt		1.00	0.85		1.00	0.85				1.00	1.00	0.85		
Flt Protected		1.00	1.00		1.00	1.00				0.95	0.95	1.00		
Satd. Flow (prot)		3034	1340		3406	1524				1573	1573	1679		
Flt Permitted		1.00	1.00		1.00	1.00				0.95	0.95	1.00		
Satd. Flow (perm)		3034	1340		3406	1524				1573	1573	1679		
Peak-hour factor, PHF	0.94	0.94	0.94	0.94	0.94	0.94	0.94	0.94	0.94	0.94	0.94	0.94		
Adj. Flow (vph)	0	998	373	0	764	124	0	0	0	553	0	1043		
RTOR Reduction (vph)	0	0	0	0	0	0	0	0	0	0	0	8		
Lane Group Flow (vph)	0	998	373	0	764	124	0	0	0	276	277	1035		
Confl. Peds. (#/hr)			2											
Heavy Vehicles (%)	19%	19%	19%	6%	6%	6%	0%	0%	0%	9%	9%	9%		
Turn Type		NA	Free		NA	Free				Split	NA	custom		
Protected Phases		2			6					4	4	5		
Permitted Phases			Free		6	Free						4		
Actuated Green, G (s)		64.9	95.0		22.0	95.0				20.6	20.6	59.0		
Effective Green, g (s)		65.9	95.0		23.0	95.0				21.1	21.1	60.0		
Actuated g/C Ratio		0.69	1.00		0.24	1.00				0.22	0.22	0.63		
Clearance Time (s)		5.0			5.0					4.5	4.5	4.5		
Vehicle Extension (s)		4.1			4.1					2.3	2.3	2.3		
Lane Grp Cap (vph)		2104	1340		824	1524				349	349	1131		
v/s Ratio Prot		0.33			c0.22					0.18	0.18	c0.37		
v/s Ratio Perm			0.28			0.08						0.24		
v/c Ratio		0.47	0.28		0.93	0.08				0.79	0.79	0.91		
Uniform Delay, d1		6.6	0.0		35.2	0.0				34.9	34.9	15.3		
Progression Factor		2.22	1.00		0.60	1.00				1.00	1.00	1.00		
Incremental Delay, d2		0.6	0.4		16.5	0.1				11.1	11.2	11.2		
Delay (s)		15.4	0.4		37.7	0.1				45.9	46.1	26.5		
Level of Service		B	A		D	A				D	D	C		
Approach Delay (s)		11.3			32.5			0.0			33.3			
Approach LOS		B			C			A			C			
Intersection Summary														
HCM 2000 Control Delay			25.3									HCM 2000 Level of Service	C	
HCM 2000 Volume to Capacity ratio			0.96											
Actuated Cycle Length (s)			95.0							12.0				
Intersection Capacity Utilization			87.2%										ICU Level of Service	E
Analysis Period (min)			15											
c Critical Lane Group														

V/C Ratio calculated using HCM worksheet with correct critical movements and lost time

HCM 6th Signalized Intersection Summary
 11: I-5 NB Ramps & SW Elligsen Road

08/31/2021

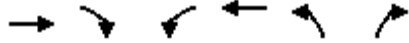

Movement	EBT	EBR	WBL	WBT	NBL	NBR
Lane Configurations	↑↑	↗		↑↑	↖↗	↗
Traffic Volume (veh/h)	743	717	0	325	509	255
Future Volume (veh/h)	743	717	0	325	509	255
Initial Q (Qb), veh	0	0	0	0	0	0
Ped-Bike Adj(A_pbT)		1.00	1.00		1.00	1.00
Parking Bus, Adj	1.00	1.00	1.00	1.00	1.00	1.00
Work Zone On Approach	No			No	No	
Adj Sat Flow, veh/h/ln	1707	1707	0	1796	1811	1811
Adj Flow Rate, veh/h	816	0	0	357	559	0
Peak Hour Factor	0.91	0.91	0.91	0.91	0.91	0.91
Percent Heavy Veh, %	13	13	0	7	6	6
Cap, veh/h	2336		0	2457	655	
Arrive On Green	0.24	0.00	0.00	0.72	0.20	0.00
Sat Flow, veh/h	3329	1447	0	3593	3346	1535
Grp Volume(v), veh/h	816	0	0	357	559	0
Grp Sat Flow(s),veh/h/ln	1622	1447	0	1706	1673	1535
Q Serve(g_s), s	19.9	0.0	0.0	3.1	15.3	0.0
Cycle Q Clear(g_c), s	19.9	0.0	0.0	3.1	15.3	0.0
Prop In Lane		1.00	0.00		1.00	1.00
Lane Grp Cap(c), veh/h	2336		0	2457	655	
V/C Ratio(X)	0.35		0.00	0.15	0.85	
Avail Cap(c_a), veh/h	2336		0	2457	810	
HCM Platoon Ratio	0.33	0.33	1.00	1.00	1.00	1.00
Upstream Filter(I)	0.82	0.00	0.00	1.00	1.00	0.00
Uniform Delay (d), s/veh	17.7	0.0	0.0	4.2	36.9	0.0
Incr Delay (d2), s/veh	0.3	0.0	0.0	0.1	6.7	0.0
Initial Q Delay(d3),s/veh	0.0	0.0	0.0	0.0	0.0	0.0
%ile BackOfQ(50%),veh/ln	8.6	0.0	0.0	0.9	6.8	0.0
Unsig. Movement Delay, s/veh						
LnGrp Delay(d),s/veh	18.1	0.0	0.0	4.3	43.6	0.0
LnGrp LOS	B		A	A	D	
Approach Vol, veh/h	816	A		357	559	A
Approach Delay, s/veh	18.1			4.3	43.6	
Approach LOS	B			A	D	
Timer - Assigned Phs		2			6	8
Phs Duration (G+Y+Rc), s		72.4			72.4	22.6
Change Period (Y+Rc), s		5.0			5.0	4.5
Max Green Setting (Gmax), s		63.0			63.0	22.5
Max Q Clear Time (g_c+I1), s		21.9			5.1	17.3
Green Ext Time (p_c), s		10.1			3.8	0.8

Intersection Summary

HCM 6th Ctrl Delay	23.5
HCM 6th LOS	C

Notes

Unsignalized Delay for [NBR, EBR] is excluded from calculations of the approach delay and intersection delay.

HCM 6th TWSC
 12: Site Access/SW 89th Avenue & SW Norwood Road

08/31/2021

Intersection

Int Delay, s/veh 2.7

Movement	EBL	EBT	EBR	WBL	WBT	WBR	NBL	NBT	NBR	SBL	SBT	SBR
Lane Configurations		↕			↕			↕			↕	
Traffic Vol, veh/h	14	113	11	3	179	2	33	0	8	18	0	25
Future Vol, veh/h	14	113	11	3	179	2	33	0	8	18	0	25
Conflicting Peds, #/hr	1	0	0	0	0	2	0	0	0	2	0	1
Sign Control	Free	Free	Free	Free	Free	Free	Stop	Stop	Stop	Stop	Stop	Stop
RT Channelized	-	-	None	-	-	None	-	-	None	-	-	None
Storage Length	-	-	-	-	-	-	-	-	-	-	-	-
Veh in Median Storage, #	-	0	-	-	0	-	-	0	-	-	0	-
Grade, %	-	0	-	-	0	-	-	0	-	-	0	-
Peak Hour Factor	80	80	80	80	80	80	80	80	80	80	80	80
Heavy Vehicles, %	0	0	2	2	2	2	2	2	2	0	2	0
Mvmt Flow	18	141	14	4	224	3	41	0	10	23	0	31

Major/Minor	Major1		Major2		Minor1		Minor2					
Conflicting Flow All	229	0	0	155	0	0	434	421	150	427	427	229
Stage 1	-	-	-	-	-	-	184	184	-	236	236	-
Stage 2	-	-	-	-	-	-	250	237	-	191	191	-
Critical Hdwy	4.1	-	-	4.12	-	-	7.12	6.52	6.22	7.1	6.52	6.2
Critical Hdwy Stg 1	-	-	-	-	-	-	6.12	5.52	-	6.1	5.52	-
Critical Hdwy Stg 2	-	-	-	-	-	-	6.12	5.52	-	6.1	5.52	-
Follow-up Hdwy	2.2	-	-	2.218	-	-	3.518	4.018	3.318	3.5	4.018	3.3
Pot Cap-1 Maneuver	1351	-	-	1425	-	-	532	524	896	541	520	815
Stage 1	-	-	-	-	-	-	818	747	-	772	710	-
Stage 2	-	-	-	-	-	-	754	709	-	815	742	-
Platoon blocked, %		-	-		-	-						
Mov Cap-1 Maneuver	1348	-	-	1425	-	-	504	514	894	526	510	813
Mov Cap-2 Maneuver	-	-	-	-	-	-	504	514	-	526	510	-
Stage 1	-	-	-	-	-	-	806	736	-	759	706	-
Stage 2	-	-	-	-	-	-	722	705	-	792	731	-

Approach	EB	WB	NB	SB
HCM Control Delay, s	0.8	0.1	12.2	10.9
HCM LOS			B	B

Minor Lane/Major Mvmt	NBLn1	EBL	EBT	EBR	WBL	WBT	WBR	SBLn1
Capacity (veh/h)	551	1348	-	-	1425	-	-	662
HCM Lane V/C Ratio	0.093	0.013	-	-	0.003	-	-	0.081
HCM Control Delay (s)	12.2	7.7	0	-	7.5	0	-	10.9
HCM Lane LOS	B	A	A	-	A	A	-	B
HCM 95th %tile Q(veh)	0.3	0	-	-	0	-	-	0.3

Intersection												
Int Delay, s/veh	4.1											
Movement	EBL	EBT	EBR	WBL	WBT	WBR	NBL	NBT	NBR	SBL	SBT	SBR
Lane Configurations		↕			↕			↕			↕	
Traffic Vol, veh/h	20	107	12	1	103	6	38	0	4	38	0	43
Future Vol, veh/h	20	107	12	1	103	6	38	0	4	38	0	43
Conflicting Peds, #/hr	0	0	0	0	0	0	0	0	0	0	0	0
Sign Control	Free	Free	Free	Free	Free	Free	Stop	Stop	Stop	Stop	Stop	Stop
RT Channelized	-	-	None	-	-	None	-	-	None	-	-	None
Storage Length	-	-	-	-	-	-	-	-	-	-	-	-
Veh in Median Storage, #	-	0	-	-	0	-	-	0	-	-	0	-
Grade, %	-	0	-	-	0	-	-	0	-	-	0	-
Peak Hour Factor	81	81	81	81	81	81	81	81	81	81	81	81
Heavy Vehicles, %	0	0	2	2	3	3	2	2	2	0	2	0
Mvmt Flow	25	132	15	1	127	7	47	0	5	47	0	53

Major/Minor	Major1			Major2			Minor1			Minor2		
Conflicting Flow All	134	0	0	147	0	0	349	326	140	325	330	131
Stage 1	-	-	-	-	-	-	190	190	-	133	133	-
Stage 2	-	-	-	-	-	-	159	136	-	192	197	-
Critical Hdwy	4.1	-	-	4.12	-	-	7.12	6.52	6.22	7.1	6.52	6.2
Critical Hdwy Stg 1	-	-	-	-	-	-	6.12	5.52	-	6.1	5.52	-
Critical Hdwy Stg 2	-	-	-	-	-	-	6.12	5.52	-	6.1	5.52	-
Follow-up Hdwy	2.2	-	-	2.218	-	-	3.518	4.018	3.318	3.5	4.018	3.3
Pot Cap-1 Maneuver	1463	-	-	1435	-	-	606	592	908	632	589	924
Stage 1	-	-	-	-	-	-	812	743	-	875	786	-
Stage 2	-	-	-	-	-	-	843	784	-	814	738	-
Platoon blocked, %	-	-	-	-	-	-	-	-	-	-	-	-
Mov Cap-1 Maneuver	1463	-	-	1435	-	-	562	580	908	619	577	924
Mov Cap-2 Maneuver	-	-	-	-	-	-	562	580	-	619	577	-
Stage 1	-	-	-	-	-	-	797	729	-	858	785	-
Stage 2	-	-	-	-	-	-	794	783	-	794	724	-

Approach	EB			WB			NB			SB		
HCM Control Delay, s	1.1			0.1			11.8			10.5		
HCM LOS							B			B		

Minor Lane/Major Mvmt	NBLn1	EBL	EBT	EBR	WBL	WBT	WBR	SBLn1
Capacity (veh/h)	583	1463	-	-	1435	-	-	751
HCM Lane V/C Ratio	0.089	0.017	-	-	0.001	-	-	0.133
HCM Control Delay (s)	11.8	7.5	0	-	7.5	0	-	10.5
HCM Lane LOS	B	A	A	-	A	A	-	B
HCM 95th %tile Q(veh)	0.3	0.1	-	-	0	-	-	0.5

HCM 6th TWSC
 14: SW 82nd Avenue & SW Norwood Road/Driveway

08/31/2021

Intersection												
Int Delay, s/veh	7.3											
Movement	EBL	EBT	EBR	WBL	WBT	WBR	NBL	NBT	NBR	SBL	SBT	SBR
Lane Configurations		↕			↕			↕			↕	↕
Traffic Vol, veh/h	124	0	24	0	0	0	36	4	0	0	0	74
Future Vol, veh/h	124	0	24	0	0	0	36	4	0	0	0	74
Conflicting Peds, #/hr	0	0	0	0	0	0	0	0	0	0	0	0
Sign Control	Free	Free	Free	Free	Free	Free	Stop	Stop	Stop	Stop	Stop	Stop
RT Channelized	-	-	None	-	-	None	-	-	None	-	-	Free
Storage Length	-	-	-	-	-	-	-	-	-	-	-	15
Veh in Median Storage, #	-	0	-	-	0	-	-	0	-	-	0	-
Grade, %	-	0	-	-	0	-	-	0	-	-	0	-
Peak Hour Factor	89	89	89	89	89	89	89	89	89	89	89	89
Heavy Vehicles, %	2	2	2	0	0	0	6	6	6	10	10	10
Mvmt Flow	139	0	27	0	0	0	40	4	0	0	0	83

Major/Minor	Major1			Major2			Minor1			Minor2		
Conflicting Flow All	1	0	0	27	0	0	293	293	14	295	306	-
Stage 1	-	-	-	-	-	-	292	292	-	1	1	-
Stage 2	-	-	-	-	-	-	1	1	-	294	305	-
Critical Hdwy	4.12	-	-	4.1	-	-	7.16	6.56	6.26	7.2	6.6	-
Critical Hdwy Stg 1	-	-	-	-	-	-	6.16	5.56	-	6.2	5.6	-
Critical Hdwy Stg 2	-	-	-	-	-	-	6.16	5.56	-	6.2	5.6	-
Follow-up Hdwy	2.218	-	-	2.2	-	-	3.554	4.054	3.354	3.59	4.09	-
Pot Cap-1 Maneuver	1622	-	-	1600	-	-	651	611	1054	642	595	0
Stage 1	-	-	-	-	-	-	707	664	-	1002	879	0
Stage 2	-	-	-	-	-	-	1012	887	-	697	648	0
Platoon blocked, %	-	-	-	-	-	-	-	-	-	-	-	-
Mov Cap-1 Maneuver	1622	-	-	1600	-	-	607	558	1054	596	543	-
Mov Cap-2 Maneuver	-	-	-	-	-	-	607	558	-	596	543	-
Stage 1	-	-	-	-	-	-	645	606	-	915	879	-
Stage 2	-	-	-	-	-	-	1012	887	-	632	592	-

Approach	EB	WB	NB	SB
HCM Control Delay, s	6.2	0	11.5	0
HCM LOS			B	A

Minor Lane/Major Mvmt	NBLn1	EBL	EBT	EBR	WBL	WBT	WBR	SBLn1	SBLn2
Capacity (veh/h)	602	1622	-	-	1600	-	-	-	-
HCM Lane V/C Ratio	0.075	0.086	-	-	-	-	-	-	-
HCM Control Delay (s)	11.5	7.4	0	-	0	-	-	0	0
HCM Lane LOS	B	A	A	-	A	-	-	A	A
HCM 95th %tile Q(veh)	0.2	0.3	-	-	0	-	-	-	-

HCM 6th TWSC
 15: SW 65th Avenue & SW Norwood Road

08/31/2021

Intersection						
Int Delay, s/veh	5.1					
Movement	EBL	EBR	NBL	NBT	SBT	SBR
Lane Configurations	T			T		T
Traffic Vol, veh/h	134	52	38	338	235	61
Future Vol, veh/h	134	52	38	338	235	61
Conflicting Peds, #/hr	2	2	2	0	0	2
Sign Control	Stop	Stop	Free	Free	Free	Free
RT Channelized	-	None	-	None	-	None
Storage Length	-	-	-	-	-	-
Veh in Median Storage, #	0	-	-	0	0	-
Grade, %	0	-	-	0	0	-
Peak Hour Factor	90	90	90	90	90	90
Heavy Vehicles, %	2	2	2	2	6	6
Mvmt Flow	149	58	42	376	261	68

Major/Minor	Minor2	Major1	Major2			
Conflicting Flow All	759	299	331	0	-	0
Stage 1	297	-	-	-	-	-
Stage 2	462	-	-	-	-	-
Critical Hdwy	6.42	6.22	4.12	-	-	-
Critical Hdwy Stg 1	5.42	-	-	-	-	-
Critical Hdwy Stg 2	5.42	-	-	-	-	-
Follow-up Hdwy	3.518	3.318	2.218	-	-	-
Pot Cap-1 Maneuver	374	741	1228	-	-	-
Stage 1	754	-	-	-	-	-
Stage 2	634	-	-	-	-	-
Platoon blocked, %				-	-	-
Mov Cap-1 Maneuver	356	738	1226	-	-	-
Mov Cap-2 Maneuver	356	-	-	-	-	-
Stage 1	720	-	-	-	-	-
Stage 2	633	-	-	-	-	-

Approach	EB	NB	SB
HCM Control Delay, s	21.9	0.8	0
HCM LOS	C		

Minor Lane/Major Mvmt	NBL	NBT	EBLn1	SBT	SBR
Capacity (veh/h)	1226	-	416	-	-
HCM Lane V/C Ratio	0.034	-	0.497	-	-
HCM Control Delay (s)	8	0	21.9	-	-
HCM Lane LOS	A	A	C	-	-
HCM 95th %tile Q(veh)	0.1	-	2.7	-	-

HCM 6th Signalized Intersection Summary

1: SW Boones Ferry Rd & SW Sagert St

08/31/2021



Movement	EBL	EBT	EBR	WBL	WBT	WBR	NBL	NBT	NBR	SBL	SBT	SBR
Lane Configurations												
Traffic Volume (veh/h)	54	166	10	224	94	41	21	375	297	87	647	58
Future Volume (veh/h)	54	166	10	224	94	41	21	375	297	87	647	58
Initial Q (Qb), veh	0	0	0	0	0	0	0	0	0	0	0	0
Ped-Bike Adj(A_pbT)	0.99		0.99	1.00		1.00	1.00		0.98	1.00		0.98
Parking Bus, Adj	1.00	1.00	1.00	1.00	1.00	1.00	1.00	1.00	1.00	1.00	1.00	1.00
Work Zone On Approach		No			No			No			No	
Adj Sat Flow, veh/h/ln	1885	1885	1885	1900	1900	1900	1885	1885	1885	1885	1885	1885
Adj Flow Rate, veh/h	59	182	11	246	103	29	23	412	299	96	711	31
Peak Hour Factor	0.91	0.91	0.91	0.91	0.91	0.91	0.91	0.91	0.91	0.91	0.91	0.91
Percent Heavy Veh, %	1	1	1	0	0	0	1	1	1	1	1	1
Cap, veh/h	343	237	14	358	304	86	300	494	359	287	980	811
Arrive On Green	0.05	0.13	0.13	0.13	0.21	0.21	0.03	0.49	0.48	0.06	0.52	0.52
Sat Flow, veh/h	1795	1759	106	1810	1424	401	1795	1004	729	1795	1885	1560
Grp Volume(v), veh/h	59	0	193	246	0	132	23	0	711	96	711	31
Grp Sat Flow(s),veh/h/ln	1795	0	1865	1810	0	1826	1795	0	1733	1795	1885	1560
Q Serve(g_s), s	2.4	0.0	8.6	9.6	0.0	5.3	0.5	0.0	30.4	2.2	24.9	0.8
Cycle Q Clear(g_c), s	2.4	0.0	8.6	9.6	0.0	5.3	0.5	0.0	30.4	2.2	24.9	0.8
Prop In Lane	1.00		0.06	1.00		0.22	1.00		0.42	1.00		1.00
Lane Grp Cap(c), veh/h	343	0	251	358	0	389	300	0	853	287	980	811
V/C Ratio(X)	0.17	0.00	0.77	0.69	0.00	0.34	0.08	0.00	0.83	0.33	0.73	0.04
Avail Cap(c_a), veh/h	484	0	348	358	0	389	476	0	1132	412	1232	1020
HCM Platoon Ratio	1.00	1.00	1.00	1.00	1.00	1.00	1.00	1.00	1.00	1.00	1.00	1.00
Upstream Filter(I)	1.00	0.00	1.00	1.00	0.00	1.00	1.00	0.00	1.00	1.00	1.00	1.00
Uniform Delay (d), s/veh	29.5	0.0	35.8	26.1	0.0	28.6	13.2	0.0	19.0	15.6	15.9	10.1
Incr Delay (d2), s/veh	0.1	0.0	4.1	4.5	0.0	0.2	0.0	0.0	5.3	0.3	2.2	0.0
Initial Q Delay(d3),s/veh	0.0	0.0	0.0	0.0	0.0	0.0	0.0	0.0	0.0	0.0	0.0	0.0
%ile BackOfQ(50%),veh/ln	1.0	0.0	4.1	4.5	0.0	2.3	0.2	0.0	12.4	0.8	10.4	0.3
Unsig. Movement Delay, s/veh												
LnGrp Delay(d),s/veh	29.5	0.0	39.9	30.6	0.0	28.8	13.2	0.0	24.2	15.8	18.1	10.1
LnGrp LOS	C	A	D	C	A	C	B	A	C	B	B	B
Approach Vol, veh/h		252			378			734			838	
Approach Delay, s/veh		37.5			30.0			23.9			17.5	
Approach LOS		D			C			C			B	
Timer - Assigned Phs	1	2	3	4	5	6	7	8				
Phs Duration (G+Y+Rc), s	9.0	46.2	15.0	15.6	6.6	48.5	8.3	22.3				
Change Period (Y+Rc), s	4.5	5.0	4.5	4.5	4.5	5.0	4.5	4.5				
Max Green Setting (Gmax), s	10.5	55.0	10.5	15.5	10.5	55.0	10.5	15.5				
Max Q Clear Time (g_c+I1), s	4.2	32.4	11.6	10.6	2.5	26.9	4.4	7.3				
Green Ext Time (p_c), s	0.1	8.8	0.0	0.3	0.0	9.6	0.0	0.2				

Intersection Summary

HCM 6th Ctrl Delay	24.1
HCM 6th LOS	C

Notes

User approved pedestrian interval to be less than phase max green.

HCM 6th Signalized Intersection Summary

2: SW Boones Ferry Rd & SW Avery St

08/31/2021



Movement	EBL	EBT	EBR	WBL	WBT	WBR	NBL	NBT	NBR	SBL	SBT	SBR
Lane Configurations												
Traffic Volume (veh/h)	248	126	272	51	43	8	117	436	42	14	765	102
Future Volume (veh/h)	248	126	272	51	43	8	117	436	42	14	765	102
Initial Q (Qb), veh	0	0	0	0	0	0	0	0	0	0	0	0
Ped-Bike Adj(A_pbT)	0.99		0.97	1.00		0.99	1.00		0.98	1.00		0.98
Parking Bus, Adj	1.00	1.00	1.00	1.00	1.00	1.00	1.00	1.00	1.00	1.00	1.00	1.00
Work Zone On Approach		No		No		No		No		No		No
Adj Sat Flow, veh/h/ln	1841	1841	1841	1870	1870	1870	1811	1811	1811	1870	1870	1870
Adj Flow Rate, veh/h	258	131	210	53	45	3	122	454	39	15	797	96
Peak Hour Factor	0.96	0.96	0.96	0.96	0.96	0.96	0.96	0.96	0.96	0.96	0.96	0.96
Percent Heavy Veh, %	4	4	4	2	2	2	6	6	6	2	2	2
Cap, veh/h	439	145	232	149	216	14	200	936	80	449	880	106
Arrive On Green	0.14	0.23	0.22	0.04	0.12	0.12	0.05	0.57	0.56	0.02	0.54	0.54
Sat Flow, veh/h	1753	623	999	1781	1732	115	1725	1641	141	1781	1632	197
Grp Volume(v), veh/h	258	0	341	53	0	48	122	0	493	15	0	893
Grp Sat Flow(s),veh/h/ln	1753	0	1622	1781	0	1848	1725	0	1782	1781	0	1829
Q Serve(g_s), s	13.8	0.0	22.7	2.9	0.0	2.6	3.5	0.0	18.2	0.4	0.0	48.8
Cycle Q Clear(g_c), s	13.8	0.0	22.7	2.9	0.0	2.6	3.5	0.0	18.2	0.4	0.0	48.8
Prop In Lane	1.00		0.62	1.00		0.06	1.00		0.08	1.00		0.11
Lane Grp Cap(c), veh/h	439	0	377	149	0	230	200	0	1017	449	0	986
V/C Ratio(X)	0.59	0.00	0.91	0.36	0.00	0.21	0.61	0.00	0.48	0.03	0.00	0.91
Avail Cap(c_a), veh/h	519	0	380	181	0	230	210	0	1061	516	0	1089
HCM Platoon Ratio	1.00	1.00	1.00	1.00	1.00	1.00	1.00	1.00	1.00	1.00	1.00	1.00
Upstream Filter(I)	1.00	0.00	1.00	1.00	0.00	1.00	1.00	0.00	1.00	1.00	0.00	1.00
Uniform Delay (d), s/veh	34.1	0.0	41.7	41.7	0.0	43.6	24.3	0.0	14.2	12.7	0.0	23.0
Incr Delay (d2), s/veh	0.5	0.0	23.8	0.5	0.0	0.2	3.2	0.0	0.5	0.0	0.0	10.6
Initial Q Delay(d3),s/veh	0.0	0.0	0.0	0.0	0.0	0.0	0.0	0.0	0.0	0.0	0.0	0.0
%ile BackOfQ(50%),veh/ln	5.9	0.0	11.5	1.3	0.0	1.2	1.9	0.0	7.2	0.2	0.0	22.7
Unsig. Movement Delay, s/veh												
LnGrp Delay(d),s/veh	34.5	0.0	65.5	42.2	0.0	43.8	27.4	0.0	14.7	12.7	0.0	33.6
LnGrp LOS	C	A	E	D	A	D	C	A	B	B	A	C
Approach Vol, veh/h		599			101			615			908	
Approach Delay, s/veh		52.2			43.0			17.2			33.2	
Approach LOS		D			D			B			C	
Timer - Assigned Phs	1	2	3	4	5	6	7	8				
Phs Duration (G+Y+Rc), s	5.8	67.3	8.0	29.7	9.4	63.8	19.9	17.8				
Change Period (Y+Rc), s	4.0	5.5	4.0	5.0	4.0	5.5	4.0	5.0				
Max Green Setting (Gmax), s	6.0	64.5	6.0	25.0	6.0	64.5	21.0	10.0				
Max Q Clear Time (g_c+1), s	12.4	20.2	4.9	24.7	5.5	50.8	15.8	4.6				
Green Ext Time (p_c), s	0.0	5.4	0.0	0.1	0.0	7.5	0.1	0.0				

Intersection Summary

HCM 6th Ctrl Delay	34.3
HCM 6th LOS	C

Notes

User approved pedestrian interval to be less than phase max green.

HCM 6th Signalized Intersection Summary

3: SW Boones Ferry Road & SW Ibach Street/SW Ibach Court

08/31/2021



Movement	EBL	EBT	EBR	WBL	WBT	WBR	NBL	NBT	NBR	SBL	SBT	SBR
Lane Configurations												
Traffic Volume (veh/h)	159	0	164	3	1	5	197	433	2	12	799	280
Future Volume (veh/h)	159	0	164	3	1	5	197	433	2	12	799	280
Initial Q (Qb), veh	0	0	0	0	0	0	0	0	0	0	0	0
Ped-Bike Adj(A_pbT)	0.95		0.98	0.98		0.95	1.00		0.99	1.00		0.99
Parking Bus, Adj	1.00	1.00	1.00	1.00	1.00	1.00	1.00	1.00	1.00	1.00	1.00	1.00
Work Zone On Approach		No			No			No			No	
Adj Sat Flow, veh/h/ln	1885	1885	1885	1900	1900	1900	1841	1841	1841	1870	1870	1870
Adj Flow Rate, veh/h	166	0	67	3	1	5	205	451	2	12	832	235
Peak Hour Factor	0.96	0.96	0.96	0.96	0.96	0.96	0.96	0.96	0.96	0.96	0.96	0.96
Percent Heavy Veh, %	1	1	1	0	0	0	4	4	4	2	2	2
Cap, veh/h	309	0	253	117	53	139	238	1207	5	21	1001	842
Arrive On Green	0.16	0.00	0.16	0.16	0.16	0.16	0.14	0.66	0.66	0.01	0.54	0.54
Sat Flow, veh/h	1348	0	1558	355	329	854	1753	1831	8	1781	1870	1573
Grp Volume(v), veh/h	166	0	67	9	0	0	205	0	453	12	832	235
Grp Sat Flow(s),veh/h/ln	1348	0	1558	1538	0	0	1753	0	1839	1781	1870	1573
Q Serve(g_s), s	9.1	0.0	3.0	0.0	0.0	0.0	9.3	0.0	9.0	0.5	30.2	6.6
Cycle Q Clear(g_c), s	9.4	0.0	3.0	0.4	0.0	0.0	9.3	0.0	9.0	0.5	30.2	6.6
Prop In Lane	1.00		1.00	0.33		0.56	1.00		0.00	1.00		1.00
Lane Grp Cap(c), veh/h	309	0	253	309	0	0	238	0	1213	21	1001	842
V/C Ratio(X)	0.54	0.00	0.26	0.03	0.00	0.00	0.86	0.00	0.37	0.58	0.83	0.28
Avail Cap(c_a), veh/h	515	0	491	471	0	0	238	0	1249	242	1270	1068
HCM Platoon Ratio	1.00	1.00	1.00	1.00	1.00	1.00	1.00	1.00	1.00	1.00	1.00	1.00
Upstream Filter(I)	1.00	0.00	1.00	1.00	0.00	0.00	1.00	0.00	1.00	1.00	1.00	1.00
Uniform Delay (d), s/veh	32.3	0.0	29.7	28.6	0.0	0.0	34.3	0.0	6.2	39.8	15.8	10.3
Incr Delay (d2), s/veh	0.9	0.0	0.3	0.0	0.0	0.0	25.3	0.0	0.3	14.4	4.6	0.3
Initial Q Delay(d3),s/veh	0.0	0.0	0.0	0.0	0.0	0.0	0.0	0.0	0.0	0.0	0.0	0.0
%ile BackOfQ(50%),veh/ln	3.1	0.0	1.1	0.1	0.0	0.0	5.5	0.0	2.8	0.3	12.3	2.1
Unsig. Movement Delay, s/veh												
LnGrp Delay(d),s/veh	33.2	0.0	30.0	28.6	0.0	0.0	59.6	0.0	6.5	54.3	20.3	10.6
LnGrp LOS	C	A	C	C	A	A	E	A	A	D	C	B
Approach Vol, veh/h		233			9			658			1079	
Approach Delay, s/veh		32.3			28.6			23.1			18.6	
Approach LOS		C			C			C			B	
Timer - Assigned Phs	1	2		4	5	6		8				
Phs Duration (G+Y+Rc), s	4.9	58.4		17.6	15.0	48.4		17.6				
Change Period (Y+Rc), s	4.0	5.0		4.5	4.0	5.0		4.5				
Max Green Setting (Gmax), s	1.0	55.0		25.5	11.0	55.0		22.0				
Max Q Clear Time (g_c+1/2), s	12.5	11.0		11.4	11.3	32.2		2.4				
Green Ext Time (p_c), s	0.0	5.1		0.5	0.0	11.2		0.0				

Intersection Summary

HCM 6th Ctrl Delay	21.7
HCM 6th LOS	C

HCM 6th TWSC
 4: SW Boones Ferry Road & SW Iowa Drive

08/31/2021

Intersection												
Int Delay, s/veh	5.2											
Movement	EBL	EBT	EBR	WBL	WBT	WBR	NBL	NBT	NBR	SBL	SBT	SBR
Lane Configurations		↕			↕		↕	↕		↕	↕	
Traffic Vol, veh/h	36	0	34	13	1	37	33	532	29	35	799	49
Future Vol, veh/h	36	0	34	13	1	37	33	532	29	35	799	49
Conflicting Peds, #/hr	0	0	4	4	0	0	4	0	4	0	0	0
Sign Control	Stop	Stop	Stop	Stop	Stop	Stop	Free	Free	Free	Free	Free	Free
RT Channelized	-	-	None	-	-	None	-	-	None	-	-	None
Storage Length	-	-	-	-	-	-	95	-	-	105	-	-
Veh in Median Storage, #	-	0	-	-	0	-	-	0	-	-	0	-
Grade, %	-	0	-	-	0	-	-	0	-	-	0	-
Peak Hour Factor	94	94	94	94	94	94	94	94	94	94	94	94
Heavy Vehicles, %	5	5	5	2	2	2	3	3	3	1	1	1
Mvmt Flow	38	0	36	14	1	39	35	566	31	37	850	52

Major/Minor	Minor2		Minor1		Major1			Major2				
Conflicting Flow All	1626	1625	884	1628	1636	586	906	0	0	601	0	0
Stage 1	954	954	-	656	656	-	-	-	-	-	-	-
Stage 2	672	671	-	972	980	-	-	-	-	-	-	-
Critical Hdwy	7.15	6.55	6.25	7.12	6.52	6.22	4.13	-	-	4.11	-	-
Critical Hdwy Stg 1	6.15	5.55	-	6.12	5.52	-	-	-	-	-	-	-
Critical Hdwy Stg 2	6.15	5.55	-	6.12	5.52	-	-	-	-	-	-	-
Follow-up Hdwy	3.545	4.045	3.345	3.518	4.018	3.318	2.227	-	-	2.209	-	-
Pot Cap-1 Maneuver	81	101	340	82	101	510	747	-	-	981	-	-
Stage 1	307	333	-	454	462	-	-	-	-	-	-	-
Stage 2	440	450	-	304	328	-	-	-	-	-	-	-
Platoon blocked, %								-	-	-	-	-
Mov Cap-1 Maneuver	69	92	337	68	92	508	744	-	-	977	-	-
Mov Cap-2 Maneuver	69	92	-	68	92	-	-	-	-	-	-	-
Stage 1	291	319	-	431	438	-	-	-	-	-	-	-
Stage 2	386	427	-	260	314	-	-	-	-	-	-	-

Approach	EB		WB		NB		SB	
HCM Control Delay, s	85.4		32.1		0.6		0.4	
HCM LOS	F		D					

Minor Lane/Major Mvmt	NBL	NBT	NBR	EBLn1WBLn1	SBL	SBT	SBR
Capacity (veh/h)	744	-	-	112	186	977	-
HCM Lane V/C Ratio	0.047	-	-	0.665	0.292	0.038	-
HCM Control Delay (s)	10.1	-	-	85.4	32.1	8.8	-
HCM Lane LOS	B	-	-	F	D	A	-
HCM 95th %tile Q(veh)	0.1	-	-	3.4	1.2	0.1	-

HCM 6th TWSC
 5: SW Boones Ferry Road & SW Norwood Road

08/31/2021

Intersection						
Int Delay, s/veh	3.2					
Movement	WBL	WBR	NBT	NBR	SBL	SBT
Lane Configurations	Y		↑	↑	↑	↑
Traffic Vol, veh/h	63	98	495	136	126	720
Future Vol, veh/h	63	98	495	136	126	720
Conflicting Peds, #/hr	2	2	0	2	2	0
Sign Control	Stop	Stop	Free	Free	Free	Free
RT Channelized	-	None	-	None	-	None
Storage Length	-	-	-	65	290	-
Veh in Median Storage, #	0	-	0	-	-	0
Grade, %	0	-	0	-	-	0
Peak Hour Factor	95	95	95	95	95	95
Heavy Vehicles, %	2	2	3	3	2	2
Mvmt Flow	66	103	521	143	133	758

Major/Minor	Minor1	Major1	Major2			
Conflicting Flow All	1549	525	0	0	666	0
Stage 1	523	-	-	-	-	-
Stage 2	1026	-	-	-	-	-
Critical Hdwy	6.42	6.22	-	-	4.12	-
Critical Hdwy Stg 1	5.42	-	-	-	-	-
Critical Hdwy Stg 2	5.42	-	-	-	-	-
Follow-up Hdwy	3.518	3.318	-	-	2.218	-
Pot Cap-1 Maneuver	125	552	-	-	923	-
Stage 1	595	-	-	-	-	-
Stage 2	346	-	-	-	-	-
Platoon blocked, %			-	-		
Mov Cap-1 Maneuver	107	550	-	-	921	-
Mov Cap-2 Maneuver	221	-	-	-	-	-
Stage 1	594	-	-	-	-	-
Stage 2	295	-	-	-	-	-

Approach	WB	NB	SB
HCM Control Delay, s	24.8	0	1.4
HCM LOS	C		

Minor Lane/Major Mvmt	NBT	NBRWBLn1	SBL	SBT
Capacity (veh/h)	-	-	348	921
HCM Lane V/C Ratio	-	-	0.487	0.144
HCM Control Delay (s)	-	-	24.8	9.6
HCM Lane LOS	-	-	C	A
HCM 95th %tile Q(veh)	-	-	2.6	0.5

HCM 6th TWSC
 6: SW Boones Ferry Road & Site Access

08/31/2021

Intersection						
Int Delay, s/veh	0					
Movement	WBL	WBR	NBT	NBR	SBL	SBT
Lane Configurations	↶	↷	↶		↶	↷
Traffic Vol, veh/h	0	0	627	0	0	798
Future Vol, veh/h	0	0	627	0	0	798
Conflicting Peds, #/hr	2	2	0	2	2	0
Sign Control	Stop	Stop	Free	Free	Free	Free
RT Channelized	-	None	-	None	-	None
Storage Length	-	150	-	-	150	-
Veh in Median Storage, #	2	-	0	-	-	0
Grade, %	0	-	0	-	-	0
Peak Hour Factor	95	95	95	95	95	95
Heavy Vehicles, %	0	0	3	3	2	2
Mvmt Flow	0	0	660	0	0	840

Major/Minor	Minor1	Major1	Major2			
Conflicting Flow All	1504	664	0	0	662	0
Stage 1	662	-	-	-	-	-
Stage 2	842	-	-	-	-	-
Critical Hdwy	6.4	6.2	-	-	4.12	-
Critical Hdwy Stg 1	5.4	-	-	-	-	-
Critical Hdwy Stg 2	5.4	-	-	-	-	-
Follow-up Hdwy	3.5	3.3	-	-	2.218	-
Pot Cap-1 Maneuver	135	464	-	-	927	-
Stage 1	517	-	-	-	-	-
Stage 2	426	-	-	-	-	-
Platoon blocked, %			-	-		-
Mov Cap-1 Maneuver	134	462	-	-	925	-
Mov Cap-2 Maneuver	335	-	-	-	-	-
Stage 1	516	-	-	-	-	-
Stage 2	425	-	-	-	-	-

Approach	WB	NB	SB
HCM Control Delay, s	0	0	0
HCM LOS	A		

Minor Lane/Major Mvmt	NBT	NBRWBLn1	WBLn2	SBL	SBT
Capacity (veh/h)	-	-	-	925	-
HCM Lane V/C Ratio	-	-	-	-	-
HCM Control Delay (s)	-	-	0	0	-
HCM Lane LOS	-	-	A	A	A
HCM 95th %tile Q(veh)	-	-	-	0	-

HCM 6th TWSC
7: SW Boones Ferry Road & SW Greenhill Lane

08/31/2021

Intersection						
Int Delay, s/veh	0					
Movement	WBL	WBR	NBT	NBR	SBL	SBT
Lane Configurations						
Traffic Vol, veh/h	0	0	626	2	1	796
Future Vol, veh/h	0	0	626	2	1	796
Conflicting Peds, #/hr	2	2	0	2	2	0
Sign Control	Stop	Stop	Free	Free	Free	Free
RT Channelized	-	None	-	None	-	None
Storage Length	-	-	-	-	150	-
Veh in Median Storage, #	2	-	0	-	-	0
Grade, %	0	-	0	-	-	0
Peak Hour Factor	95	95	95	95	95	95
Heavy Vehicles, %	0	0	3	3	2	2
Mvmt Flow	0	0	659	2	1	838

Major/Minor	Minor1	Major1	Major2		
Conflicting Flow All	1504	664	0	0	663
Stage 1	662	-	-	-	-
Stage 2	842	-	-	-	-
Critical Hdwy	6.4	6.2	-	-	4.12
Critical Hdwy Stg 1	5.4	-	-	-	-
Critical Hdwy Stg 2	5.4	-	-	-	-
Follow-up Hdwy	3.5	3.3	-	-	2.218
Pot Cap-1 Maneuver	135	464	-	-	926
Stage 1	517	-	-	-	-
Stage 2	426	-	-	-	-
Platoon blocked, %			-	-	-
Mov Cap-1 Maneuver	134	462	-	-	924
Mov Cap-2 Maneuver	335	-	-	-	-
Stage 1	516	-	-	-	-
Stage 2	425	-	-	-	-

Approach	WB	NB	SB
HCM Control Delay, s	0	0	0
HCM LOS	A		

Minor Lane/Major Mvmt	NBT	NBRWBLn1	SBL	SBT
Capacity (veh/h)	-	-	924	-
HCM Lane V/C Ratio	-	-	0.001	-
HCM Control Delay (s)	-	-	0	8.9
HCM Lane LOS	-	-	A	A
HCM 95th %tile Q(veh)	-	-	-	0

HCM 6th Signalized Intersection Summary

8: SW Boones Ferry Road & SW Day Road

08/31/2021



Movement	EBL	EBT	EBR	WBL	WBT	WBR	NBL	NBT	NBR	SBL	SBT	SBR
Lane Configurations		↖	↗		↔		↖↗	↖		↗	↖↗	
Traffic Volume (veh/h)	12	0	781	0	0	0	640	614	0	0	722	74
Future Volume (veh/h)	12	0	781	0	0	0	640	614	0	0	722	74
Initial Q (Qb), veh	0	0	0	0	0	0	0	0	0	0	0	0
Ped-Bike Adj(A_pbT)	1.00		1.00	1.00		1.00	1.00		1.00	1.00		1.00
Parking Bus, Adj	1.00	1.00	1.00	1.00	1.00	1.00	1.00	1.00	1.00	1.00	1.00	1.00
Work Zone On Approach		No			No			No			No	
Adj Sat Flow, veh/h/ln	1870	1870	1870	1900	1900	1900	1856	1856	1856	1885	1885	1885
Adj Flow Rate, veh/h	12	0	746	0	0	0	653	627	0	0	737	71
Peak Hour Factor	0.98	0.98	0.98	0.98	0.98	0.98	0.98	0.98	0.98	0.98	0.98	0.98
Percent Heavy Veh, %	2	2	2	0	0	0	3	3	3	1	1	1
Cap, veh/h	271	0	652	0	271	0	734	714	0	610	1595	154
Arrive On Green	0.14	0.00	0.15	0.00	0.00	0.00	0.43	0.64	0.00	0.00	0.48	0.47
Sat Flow, veh/h	1418	0	1585	0	1900	0	2827	1856	0	1795	3301	318
Grp Volume(v), veh/h	12	0	746	0	0	0	653	627	0	0	400	408
Grp Sat Flow(s),veh/h/ln	1418	0	1585	0	1900	0	1414	1856	0	1795	1791	1828
Q Serve(g_s), s	0.8	0.0	15.9	0.0	0.0	0.0	22.4	29.1	0.0	0.0	15.6	15.7
Cycle Q Clear(g_c), s	0.8	0.0	15.9	0.0	0.0	0.0	22.4	29.1	0.0	0.0	15.6	15.7
Prop In Lane	1.00		1.00	0.00		0.00	1.00		0.00	1.00		0.17
Lane Grp Cap(c), veh/h	264	0	652	0	271	0	734	714	0	610	865	883
V/C Ratio(X)	0.05	0.00	1.14	0.00	0.00	0.00	0.89	0.88	0.00	0.00	0.46	0.46
Avail Cap(c_a), veh/h	264	0	652	0	271	0	1158	1219	0	610	865	883
HCM Platoon Ratio	1.00	1.00	1.00	1.00	1.00	1.00	1.67	1.67	1.67	1.00	1.00	1.00
Upstream Filter(I)	1.00	0.00	1.00	0.00	0.00	0.00	0.91	0.91	0.00	0.00	1.00	1.00
Uniform Delay (d), s/veh	39.1	0.0	30.9	0.0	0.0	0.0	28.3	16.7	0.0	0.0	18.1	18.2
Incr Delay (d2), s/veh	0.1	0.0	82.4	0.0	0.0	0.0	4.0	13.3	0.0	0.0	1.8	1.7
Initial Q Delay(d3),s/veh	0.0	0.0	0.0	0.0	0.0	0.0	0.0	0.0	0.0	0.0	0.0	0.0
%ile BackOfQ(50%),veh/ln	0.3	0.0	30.2	0.0	0.0	0.0	6.4	10.1	0.0	0.0	6.4	6.5
Unsig. Movement Delay, s/veh												
LnGrp Delay(d),s/veh	39.2	0.0	113.3	0.0	0.0	0.0	32.4	30.0	0.0	0.0	19.8	19.9
LnGrp LOS	D	A	F	A	A	A	C	C	A	A	B	B
Approach Vol, veh/h		758			0			1280			808	
Approach Delay, s/veh		112.1			0.0			31.2			19.9	
Approach LOS		F						C			B	
Timer - Assigned Phs	1	2		4	5	6		8				
Phs Duration (G+Y+Rc), s	31.3	54.7		19.0	41.6	44.4		19.0				
Change Period (Y+Rc), s	* 5.4	* 5.4		4.5	* 5.4	* 5.4		4.5				
Max Green Setting (Gmax), s	* 42	* 34		14.5	* 8.5	* 68		14.5				
Max Q Clear Time (g_c+I1), s	24.4	17.7		0.0	0.0	31.1		17.9				
Green Ext Time (p_c), s	1.5	6.4		0.0	0.0	7.9		0.0				

Intersection Summary

HCM 6th Ctrl Delay	49.5
HCM 6th LOS	D

Notes

User approved pedestrian interval to be less than phase max green.

* HCM 6th computational engine requires equal clearance times for the phases crossing the barrier.

HCM 6th Signalized Intersection Summary
 9: SW Boones Ferry Road & SW 95th Avenue

08/31/2021



Movement	EBL	EBT	EBR	WBL	WBT	WBR	NBL	NBT	NBR	SBL	SBT	SBR
Lane Configurations		↕	↗	↖	↗	↖	↗	↖		↖	↗	↖
Traffic Volume (veh/h)	232	1	803	48	17	6	583	922	12	3	1159	236
Future Volume (veh/h)	232	1	803	48	17	6	583	922	12	3	1159	236
Initial Q (Qb), veh	0	0	0	0	0	0	0	0	0	0	0	0
Ped-Bike Adj(A_pbT)	0.99		0.97	1.00		0.99	1.00		1.00	1.00		1.00
Parking Bus, Adj	1.00	1.00	1.00	1.00	1.00	1.00	1.00	1.00	1.00	1.00	1.00	1.00
Work Zone On Approach		No		No		No		No		No		No
Adj Sat Flow, veh/h/ln	1826	1826	1826	1870	1870	1870	1781	1781	1781	1856	1856	1856
Adj Flow Rate, veh/h	242	1	836	50	18	6	607	960	12	3	1207	0
Peak Hour Factor	0.96	0.96	0.96	0.96	0.96	0.96	0.96	0.96	0.96	0.96	0.96	0.96
Percent Heavy Veh, %	5	5	5	2	2	2	8	8	8	3	3	3
Cap, veh/h	283	1	1035	75	230	77	705	1228	15	628	1763	
Arrive On Green	0.16	0.17	0.17	0.17	0.17	0.17	0.43	0.72	0.70	0.71	1.00	0.00
Sat Flow, veh/h	1249	5	2634	656	1340	447	3291	3423	43	1767	3526	1572
Grp Volume(v), veh/h	243	0	836	50	0	24	607	475	497	3	1207	0
Grp Sat Flow(s),veh/h/ln	1255	0	1317	656	0	1787	1646	1692	1774	1767	1763	1572
Q Serve(g_s), s	15.8	0.0	18.0	1.0	0.0	1.2	17.5	18.9	19.0	0.1	0.0	0.0
Cycle Q Clear(g_c), s	17.0	0.0	18.0	18.0	0.0	1.2	17.5	18.9	19.0	0.1	0.0	0.0
Prop In Lane	1.00		1.00	1.00		0.25	1.00		0.02	1.00		1.00
Lane Grp Cap(c), veh/h	272	0	1035	75	0	306	705	607	636	628	1763	
V/C Ratio(X)	0.89	0.00	0.81	0.67	0.00	0.08	0.86	0.78	0.78	0.00	0.68	
Avail Cap(c_a), veh/h	272	0	1035	75	0	306	1066	1048	1098	628	1763	
HCM Platoon Ratio	1.00	1.00	1.00	1.00	1.00	1.00	2.00	2.00	2.00	2.00	2.00	2.00
Upstream Filter(I)	1.00	0.00	1.00	1.00	0.00	1.00	0.60	0.60	0.60	0.58	0.58	0.00
Uniform Delay (d), s/veh	45.5	0.0	29.0	52.4	0.0	36.5	28.6	12.2	12.2	9.8	0.0	0.0
Incr Delay (d2), s/veh	28.8	0.0	4.7	19.0	0.0	0.1	2.9	6.0	5.7	0.0	1.3	0.0
Initial Q Delay(d3),s/veh	0.0	0.0	0.0	0.0	0.0	0.0	0.0	0.0	0.0	0.0	0.0	0.0
%ile BackOfQ(50%),veh/ln	8.6	0.0	9.8	1.7	0.0	0.5	5.3	4.7	4.9	0.0	0.3	0.0
Unsig. Movement Delay, s/veh												
LnGrp Delay(d),s/veh	74.3	0.0	33.6	71.5	0.0	36.6	31.5	18.2	18.0	9.8	1.3	0.0
LnGrp LOS	E	A	C	E	A	D	C	B	B	A	A	
Approach Vol, veh/h		1079			74			1579			1210	A
Approach Delay, s/veh		42.8			60.2			23.2			1.3	
Approach LOS		D			E			C			A	
Timer - Assigned Phs	1	2		4	5	6		8				
Phs Duration (G+Y+Rc), s	36.5	56.5		22.0	41.3	41.7		22.0				
Change Period (Y+Rc), s	5.0	5.0		5.0	5.0	5.0		5.0				
Max Green Setting (Gmax), s	33.0	40.0		17.0	9.0	64.0		17.0				
Max Q Clear Time (g_c+1), s	19.5	2.0		20.0	2.1	21.0		20.0				
Green Ext Time (p_c), s	2.0	11.2		0.0	0.0	15.7		0.0				

Intersection Summary

HCM 6th Ctrl Delay	22.6
HCM 6th LOS	C

Notes

User approved pedestrian interval to be less than phase max green.
 Unsignalized Delay for [SBR] is excluded from calculations of the approach delay and intersection delay.

HCM Signalized Intersection Capacity Analysis
 10: I-5 SB Ramps & SW Boones Ferry Road/SW Elligsen Road

08/31/2021



Movement	EBL	EBT	EBR	WBL	WBT	WBR	NBL	NBT	NBR	SBL	SBT	SBR
Lane Configurations		↑↑	↗		↑↑	↗				↘	↖	↗
Traffic Volume (vph)	0	1101	909	0	700	375	0	0	0	576	88	816
Future Volume (vph)	0	1101	909	0	700	375	0	0	0	576	88	816
Ideal Flow (vphpl)	1900	1900	1900	1900	1900	1900	1900	1900	1900	1900	1900	1900
Lane Width	12	12	12	12	12	12	12	12	12	12	12	16
Total Lost time (s)		4.0	4.0		4.0	3.0				4.0	4.0	4.0
Lane Util. Factor		0.95	1.00		0.95	1.00				0.95	0.95	1.00
Fr _t		1.00	0.85		1.00	0.85				1.00	1.00	0.85
Fl _t Protected		1.00	1.00		1.00	1.00				0.95	0.96	1.00
Satd. Flow (prot)		3505	1568		3505	1568				1603	1627	1711
Fl _t Permitted		1.00	1.00		1.00	1.00				0.95	0.96	1.00
Satd. Flow (perm)		3505	1568		3505	1568				1603	1627	1711
Peak-hour factor, PHF	0.97	0.97	0.97	0.97	0.97	0.97	0.97	0.97	0.97	0.97	0.97	0.97
Adj. Flow (vph)	0	1135	937	0	722	387	0	0	0	594	91	841
RTOR Reduction (vph)	0	0	0	0	0	0	0	0	0	0	0	60
Lane Group Flow (vph)	0	1135	937	0	722	387	0	0	0	339	346	781
Heavy Vehicles (%)	3%	3%	3%	3%	3%	3%	0%	0%	0%	7%	7%	7%
Turn Type		NA	Free		NA	Free				Split	NA	custom
Protected Phases		2			6					4	4	5
Permitted Phases			Free		6	Free						4
Actuated Green, G (s)		68.4	105.0		46.2	105.0				27.1	27.1	44.8
Effective Green, g (s)		69.4	105.0		47.2	105.0				27.6	27.6	45.8
Actuated g/C Ratio		0.66	1.00		0.45	1.00				0.26	0.26	0.44
Clearance Time (s)		5.0			5.0					4.5	4.5	4.5
Vehicle Extension (s)		4.1			4.1					2.3	2.3	2.3
Lane Grp Cap (vph)		2316	1568		1575	1568				421	427	811
v/s Ratio Prot		0.32			0.21					0.21	0.21	c0.17
v/s Ratio Perm			c0.60			0.25						0.29
v/c Ratio		0.49	0.60		0.46	0.25				0.81	0.81	0.96
Uniform Delay, d ₁		8.9	0.0		20.0	0.0				36.2	36.2	28.8
Progression Factor		0.93	1.00		1.08	1.00				1.00	1.00	1.00
Incremental Delay, d ₂		0.5	1.2		0.9	0.4				10.3	10.7	22.8
Delay (s)		8.8	1.2		22.5	0.4				46.5	47.0	51.6
Level of Service		A	A		C	A				D	D	D
Approach Delay (s)		5.4			14.8			0.0			49.4	
Approach LOS		A			B			A			D	

Intersection Summary		
HCM 2000 Control Delay	21.9	HCM 2000 Level of Service C
HCM 2000 Volume to Capacity ratio	0.84	
Actuated Cycle Length (s)	105.0	Sum of lost time (s) 12.0
Intersection Capacity Utilization	76.5%	ICU Level of Service D
Analysis Period (min)	15	

c Critical Lane Group

V/C Ratio calculated using HCM worksheet with correct critical movements and lost time

HCM 6th Signalized Intersection Summary
 11: I-5 NB Ramps & SW Elligsen Road

08/31/2021

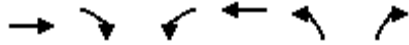

Movement	EBT	EBR	WBL	WBT	NBL	NBR
Lane Configurations	↑↑	↗		↑↑	↖↗	↗
Traffic Volume (veh/h)	979	700	0	753	323	236
Future Volume (veh/h)	979	700	0	753	323	236
Initial Q (Qb), veh	0	0	0	0	0	0
Ped-Bike Adj(A_pbT)		1.00	1.00		1.00	1.00
Parking Bus, Adj	1.00	1.00	1.00	1.00	1.00	1.00
Work Zone On Approach	No			No	No	
Adj Sat Flow, veh/h/ln	1841	1841	0	1885	1841	1841
Adj Flow Rate, veh/h	1076	0	0	827	355	0
Peak Hour Factor	0.91	0.91	0.91	0.91	0.91	0.91
Percent Heavy Veh, %	4	4	0	1	4	4
Cap, veh/h	2767		0	2834	451	
Arrive On Green	1.00	0.00	0.00	0.79	0.13	0.00
Sat Flow, veh/h	3589	1560	0	3770	3401	1560
Grp Volume(v), veh/h	1076	0	0	827	355	0
Grp Sat Flow(s),veh/h/ln	1749	1560	0	1791	1700	1560
Q Serve(g_s), s	0.0	0.0	0.0	6.6	10.6	0.0
Cycle Q Clear(g_c), s	0.0	0.0	0.0	6.6	10.6	0.0
Prop In Lane		1.00	0.00		1.00	1.00
Lane Grp Cap(c), veh/h	2767		0	2834	451	
V/C Ratio(X)	0.39		0.00	0.29	0.79	
Avail Cap(c_a), veh/h	2767		0	2834	1166	
HCM Platoon Ratio	2.00	2.00	1.00	1.00	1.00	1.00
Upstream Filter(l)	0.81	0.00	0.00	1.00	1.00	0.00
Uniform Delay (d), s/veh	0.0	0.0	0.0	3.0	44.1	0.0
Incr Delay (d2), s/veh	0.3	0.0	0.0	0.3	1.9	0.0
Initial Q Delay(d3),s/veh	0.0	0.0	0.0	0.0	0.0	0.0
%ile BackOfQ(50%),veh/ln	0.1	0.0	0.0	1.7	4.6	0.0
Unsig. Movement Delay, s/veh						
LnGrp Delay(d),s/veh	0.3	0.0	0.0	3.2	46.0	0.0
LnGrp LOS	A		A	A	D	
Approach Vol, veh/h	1076	A		827	355	A
Approach Delay, s/veh	0.3			3.2	46.0	
Approach LOS	A			A	D	
Timer - Assigned Phs		2			6	8
Phs Duration (G+Y+Rc), s		87.1			87.1	17.9
Change Period (Y+Rc), s		5.0			5.0	4.5
Max Green Setting (Gmax), s		60.0			60.0	35.5
Max Q Clear Time (g_c+I1), s		2.0			8.6	12.6
Green Ext Time (p_c), s		15.9			10.5	0.8

Intersection Summary

HCM 6th Ctrl Delay	8.6
HCM 6th LOS	A

Notes

Unsignalized Delay for [NBR, EBR] is excluded from calculations of the approach delay and intersection delay.

HCM 6th TWSC
 12: SW Norwood Road & SW 89th Avenue

08/31/2021

Intersection												
Int Delay, s/veh	1.7											
Movement	EBL	EBT	EBR	WBL	WBT	WBR	NBL	NBT	NBR	SBL	SBT	SBR
Lane Configurations		↕			↕			↕			↕	
Traffic Vol, veh/h	32	232	36	9	164	14	22	0	5	11	0	8
Future Vol, veh/h	32	232	36	9	164	14	22	0	5	11	0	8
Conflicting Peds, #/hr	2	0	0	0	0	2	0	0	0	2	0	2
Sign Control	Free	Free	Free	Free	Free	Free	Stop	Stop	Stop	Stop	Stop	Stop
RT Channelized	-	-	None	-	-	None	-	-	None	-	-	None
Storage Length	-	-	-	-	-	-	-	-	-	-	-	-
Veh in Median Storage, #	-	0	-	-	0	-	-	0	-	-	0	-
Grade, %	-	0	-	-	0	-	-	0	-	-	0	-
Peak Hour Factor	92	92	92	92	92	92	92	92	92	92	92	92
Heavy Vehicles, %	1	1	2	2	0	0	2	2	2	0	2	0
Mvmt Flow	35	252	39	10	178	15	24	0	5	12	0	9

Major/Minor	Major1			Major2			Minor1			Minor2		
Conflicting Flow All	195	0	0	291	0	0	554	557	274	554	569	190
Stage 1	-	-	-	-	-	-	342	342	-	208	208	-
Stage 2	-	-	-	-	-	-	212	215	-	346	361	-
Critical Hdwy	4.11	-	-	4.12	-	-	7.12	6.52	6.22	7.1	6.52	6.2
Critical Hdwy Stg 1	-	-	-	-	-	-	6.12	5.52	-	6.1	5.52	-
Critical Hdwy Stg 2	-	-	-	-	-	-	6.12	5.52	-	6.1	5.52	-
Follow-up Hdwy	2.209	-	-	2.218	-	-	3.518	4.018	3.318	3.5	4.018	3.3
Pot Cap-1 Maneuver	1384	-	-	1271	-	-	443	439	765	446	432	857
Stage 1	-	-	-	-	-	-	673	638	-	799	730	-
Stage 2	-	-	-	-	-	-	790	725	-	674	626	-
Platoon blocked, %	-	-	-	-	-	-	-	-	-	-	-	-
Mov Cap-1 Maneuver	1381	-	-	1271	-	-	425	421	764	428	414	854
Mov Cap-2 Maneuver	-	-	-	-	-	-	425	421	-	428	414	-
Stage 1	-	-	-	-	-	-	653	619	-	773	722	-
Stage 2	-	-	-	-	-	-	773	717	-	648	607	-

Approach	EB			WB			NB			SB		
HCM Control Delay, s	0.8			0.4			13.3			11.9		
HCM LOS							B			B		

Minor Lane/Major Mvmt	NBLn1	EBL	EBT	EBR	WBL	WBT	WBR	SBLn1
Capacity (veh/h)	463	1381	-	-	1271	-	-	542
HCM Lane V/C Ratio	0.063	0.025	-	-	0.008	-	-	0.038
HCM Control Delay (s)	13.3	7.7	0	-	7.9	0	-	11.9
HCM Lane LOS	B	A	A	-	A	A	-	B
HCM 95th %tile Q(veh)	0.2	0.1	-	-	0	-	-	0.1

HCM 6th TWSC
 13: SW Norwood Road & SW Vermillion Drive

08/31/2021

Intersection												
Int Delay, s/veh	3.3											
Movement	EBL	EBT	EBR	WBL	WBT	WBR	NBL	NBT	NBR	SBL	SBT	SBR
Lane Configurations		↕			↕			↕			↕	
Traffic Vol, veh/h	68	138	42	4	127	37	24	0	3	23	0	36
Future Vol, veh/h	68	138	42	4	127	37	24	0	3	23	0	36
Conflicting Peds, #/hr	0	0	0	0	0	0	0	0	0	0	0	0
Sign Control	Free	Free	Free	Free	Free	Free	Stop	Stop	Stop	Stop	Stop	Stop
RT Channelized	-	-	None	-	-	None	-	-	None	-	-	None
Storage Length	-	-	-	-	-	-	-	-	-	-	-	-
Veh in Median Storage, #	-	0	-	-	0	-	-	0	-	-	0	-
Grade, %	-	0	-	-	0	-	-	0	-	-	0	-
Peak Hour Factor	72	72	92	92	72	72	92	92	92	72	92	72
Heavy Vehicles, %	1	1	2	2	0	0	2	2	2	0	2	0
Mvmt Flow	94	192	46	4	176	51	26	0	3	32	0	50

Major/Minor	Major1			Major2			Minor1			Minor2		
Conflicting Flow All	227	0	0	238	0	0	638	638	215	615	636	202
Stage 1	-	-	-	-	-	-	403	403	-	210	210	-
Stage 2	-	-	-	-	-	-	235	235	-	405	426	-
Critical Hdwy	4.11	-	-	4.12	-	-	7.12	6.52	6.22	7.1	6.52	6.2
Critical Hdwy Stg 1	-	-	-	-	-	-	6.12	5.52	-	6.1	5.52	-
Critical Hdwy Stg 2	-	-	-	-	-	-	6.12	5.52	-	6.1	5.52	-
Follow-up Hdwy	2.209	-	-	2.218	-	-	3.518	4.018	3.318	3.5	4.018	3.3
Pot Cap-1 Maneuver	1347	-	-	1329	-	-	389	394	825	406	395	844
Stage 1	-	-	-	-	-	-	624	600	-	797	728	-
Stage 2	-	-	-	-	-	-	768	710	-	626	586	-
Platoon blocked, %	-	-	-	-	-	-	-	-	-	-	-	-
Mov Cap-1 Maneuver	1347	-	-	1329	-	-	342	361	825	378	362	844
Mov Cap-2 Maneuver	-	-	-	-	-	-	342	361	-	378	362	-
Stage 1	-	-	-	-	-	-	573	551	-	732	726	-
Stage 2	-	-	-	-	-	-	720	708	-	573	539	-

Approach	EB			WB			NB			SB		
HCM Control Delay, s	2.2			0.1			15.7			12.4		
HCM LOS							C			B		

Minor Lane/Major Mvmt	NBLn1	EBL	EBT	EBR	WBL	WBT	WBR	SBLn1
Capacity (veh/h)	366	1347	-	-	1329	-	-	570
HCM Lane V/C Ratio	0.08	0.07	-	-	0.003	-	-	0.144
HCM Control Delay (s)	15.7	7.9	0	-	7.7	0	-	12.4
HCM Lane LOS	C	A	A	-	A	A	-	B
HCM 95th %tile Q(veh)	0.3	0.2	-	-	0	-	-	0.5

HCM 6th TWSC
 14: SW 82nd Avenue & SW Norwood Road/Driveway

08/31/2021

Intersection												
Int Delay, s/veh	6.9											
Movement	EBL	EBT	EBR	WBL	WBT	WBR	NBL	NBT	NBR	SBL	SBT	SBR
Lane Configurations		↕			↕			↕			↕	↗
Traffic Vol, veh/h	130	0	34	0	0	1	20	7	0	2	4	148
Future Vol, veh/h	130	0	34	0	0	1	20	7	0	2	4	148
Conflicting Peds, #/hr	0	0	0	0	0	0	0	0	0	0	0	0
Sign Control	Free	Free	Free	Free	Free	Free	Stop	Stop	Stop	Stop	Stop	Stop
RT Channelized	-	-	None	-	-	None	-	-	None	-	-	Free
Storage Length	-	-	-	-	-	-	-	-	-	-	-	15
Veh in Median Storage, #	-	0	-	-	0	-	-	0	-	-	0	-
Grade, %	-	0	-	-	0	-	-	0	-	-	0	-
Peak Hour Factor	83	83	83	83	83	83	83	83	83	83	83	83
Heavy Vehicles, %	0	0	0	0	0	0	0	0	0	0	0	0
Mvmt Flow	157	0	41	0	0	1	24	8	0	2	5	178

Major/Minor	Major1			Major2			Minor1			Minor2		
Conflicting Flow All	1	0	0	41	0	0	338	336	21	340	356	-
Stage 1	-	-	-	-	-	-	335	335	-	1	1	-
Stage 2	-	-	-	-	-	-	3	1	-	339	355	-
Critical Hdwy	4.1	-	-	4.1	-	-	7.1	6.5	6.2	7.1	6.5	-
Critical Hdwy Stg 1	-	-	-	-	-	-	6.1	5.5	-	6.1	5.5	-
Critical Hdwy Stg 2	-	-	-	-	-	-	6.1	5.5	-	6.1	5.5	-
Follow-up Hdwy	2.2	-	-	2.2	-	-	3.5	4	3.3	3.5	4	-
Pot Cap-1 Maneuver	1635	-	-	1581	-	-	620	588	1062	618	573	0
Stage 1	-	-	-	-	-	-	683	646	-	1027	899	0
Stage 2	-	-	-	-	-	-	1025	899	-	680	633	0
Platoon blocked, %	-	-	-	-	-	-	-	-	-	-	-	-
Mov Cap-1 Maneuver	1635	-	-	1581	-	-	569	530	1062	564	516	-
Mov Cap-2 Maneuver	-	-	-	-	-	-	569	530	-	564	516	-
Stage 1	-	-	-	-	-	-	615	582	-	925	899	-
Stage 2	-	-	-	-	-	-	1020	899	-	604	570	-

Approach	EB	WB	NB	SB
HCM Control Delay, s	5.9	0	11.9	11.9
HCM LOS			B	B

Minor Lane/Major Mvmt	NBLn1	EBL	EBT	EBR	WBL	WBT	WBR	SBLn1	SBLn2
Capacity (veh/h)	558	1635	-	-	1581	-	-	531	-
HCM Lane V/C Ratio	0.058	0.096	-	-	-	-	-	0.014	-
HCM Control Delay (s)	11.9	7.4	0	-	0	-	-	11.9	0
HCM Lane LOS	B	A	A	-	A	-	-	B	A
HCM 95th %tile Q(veh)	0.2	0.3	-	-	0	-	-	0	-

HCM 6th TWSC
 15: SW 65th Avenue & SW Norwood Road

08/31/2021

Intersection						
Int Delay, s/veh	3.5					
Movement	EBL	EBR	NBL	NBT	SBT	SBR
Lane Configurations	T			T		T
Traffic Vol, veh/h	70	64	58	218	388	118
Future Vol, veh/h	70	64	58	218	388	118
Conflicting Peds, #/hr	0	0	0	0	0	0
Sign Control	Stop	Stop	Free	Free	Free	Free
RT Channelized	-	None	-	None	-	None
Storage Length	-	-	-	-	-	-
Veh in Median Storage, #	0	-	-	0	0	-
Grade, %	0	-	-	0	0	-
Peak Hour Factor	89	89	89	89	89	89
Heavy Vehicles, %	0	0	2	2	0	0
Mvmt Flow	79	72	65	245	436	133

Major/Minor	Minor2	Major1		Major2	
Conflicting Flow All	878	503	569	0	0
Stage 1	503	-	-	-	-
Stage 2	375	-	-	-	-
Critical Hdwy	6.4	6.2	4.12	-	-
Critical Hdwy Stg 1	5.4	-	-	-	-
Critical Hdwy Stg 2	5.4	-	-	-	-
Follow-up Hdwy	3.5	3.3	2.218	-	-
Pot Cap-1 Maneuver	321	573	1003	-	-
Stage 1	612	-	-	-	-
Stage 2	699	-	-	-	-
Platoon blocked, %				-	-
Mov Cap-1 Maneuver	297	573	1003	-	-
Mov Cap-2 Maneuver	297	-	-	-	-
Stage 1	566	-	-	-	-
Stage 2	699	-	-	-	-

Approach	EB	NB	SB
HCM Control Delay, s	20.2	1.9	0
HCM LOS	C		

Minor Lane/Major Mvmt	NBL	NBT	EBLn1	SBT	SBR
Capacity (veh/h)	1003	-	386	-	-
HCM Lane V/C Ratio	0.065	-	0.39	-	-
HCM Control Delay (s)	8.8	0	20.2	-	-
HCM Lane LOS	A	A	C	-	-
HCM 95th %tile Q(veh)	0.2	-	1.8	-	-

HCM 6th Signalized Intersection Summary
 1: SW Boones Ferry Rd & SW Sagert St

06/30/2021



Movement	EBL	EBT	EBR	WBL	WBT	WBR	NBL	NBT	NBR	SBL	SBT	SBR
Lane Configurations												
Traffic Volume (veh/h)	73	80	12	191	102	63	8	634	312	53	287	48
Future Volume (veh/h)	73	80	12	191	102	63	8	634	312	53	287	48
Initial Q (Qb), veh	0	0	0	0	0	0	0	0	0	0	0	0
Ped-Bike Adj(A_pbT)	1.00		0.99	1.00		1.00	1.00		0.98	1.00		0.98
Parking Bus, Adj	1.00	1.00	1.00	1.00	1.00	1.00	1.00	1.00	1.00	1.00	1.00	1.00
Work Zone On Approach		No			No			No			No	
Adj Sat Flow, veh/h/ln	1885	1885	1885	1900	1900	1900	1885	1885	1885	1811	1811	1811
Adj Flow Rate, veh/h	80	88	8	210	112	47	9	697	327	58	315	31
Peak Hour Factor	0.91	0.91	0.91	0.91	0.91	0.91	0.91	0.91	0.91	0.91	0.91	0.91
Percent Heavy Veh, %	1	1	1	0	0	0	1	1	1	6	6	6
Cap, veh/h	248	137	12	325	174	73	661	709	333	166	1121	929
Arrive On Green	0.06	0.08	0.08	0.12	0.14	0.13	0.02	0.59	0.58	0.05	0.62	0.62
Sat Flow, veh/h	1795	1701	155	1810	1269	533	1795	1204	565	1725	1811	1501
Grp Volume(v), veh/h	80	0	96	210	0	159	9	0	1024	58	315	31
Grp Sat Flow(s),veh/h/ln	1795	0	1856	1810	0	1802	1795	0	1768	1725	1811	1501
Q Serve(g_s), s	3.8	0.0	4.8	9.8	0.0	7.9	0.2	0.0	53.8	1.2	7.6	0.8
Cycle Q Clear(g_c), s	3.8	0.0	4.8	9.8	0.0	7.9	0.2	0.0	53.8	1.2	7.6	0.8
Prop In Lane	1.00		0.08	1.00		0.30	1.00		0.32	1.00		1.00
Lane Grp Cap(c), veh/h	248	0	149	325	0	247	661	0	1042	166	1121	929
V/C Ratio(X)	0.32	0.00	0.64	0.65	0.00	0.64	0.01	0.00	0.98	0.35	0.28	0.03
Avail Cap(c_a), veh/h	349	0	312	325	0	303	840	0	1042	285	1121	929
HCM Platoon Ratio	1.00	1.00	1.00	1.00	1.00	1.00	1.00	1.00	1.00	1.00	1.00	1.00
Upstream Filter(I)	1.00	0.00	1.00	1.00	0.00	1.00	1.00	0.00	1.00	1.00	1.00	1.00
Uniform Delay (d), s/veh	36.9	0.0	42.4	33.2	0.0	38.9	7.8	0.0	19.2	23.0	8.3	7.0
Incr Delay (d2), s/veh	0.3	0.0	1.7	3.5	0.0	1.6	0.0	0.0	23.8	0.5	0.2	0.0
Initial Q Delay(d3),s/veh	0.0	0.0	0.0	0.0	0.0	0.0	0.0	0.0	0.0	0.0	0.0	0.0
%ile BackOfQ(50%),veh/ln	1.7	0.0	2.2	4.5	0.0	3.6	0.1	0.0	26.4	0.8	2.8	0.2
Unsig. Movement Delay, s/veh												
LnGrp Delay(d),s/veh	37.1	0.0	44.1	36.7	0.0	40.6	7.8	0.0	43.0	23.4	8.6	7.1
LnGrp LOS	D	A	D	D	A	D	A	A	D	C	A	A
Approach Vol, veh/h		176			369			1033			404	
Approach Delay, s/veh		40.9			38.4			42.7			10.6	
Approach LOS		D			D			D			B	
Timer - Assigned Phs	1	2	3	4	5	6	7	8				
Phs Duration (G+Y+Rc), s	8.4	60.0	15.0	11.7	5.6	62.9	9.6	17.0				
Change Period (Y+Rc), s	4.5	5.0	4.5	4.5	4.5	5.0	4.5	4.5				
Max Green Setting (Gmax), s	10.5	55.0	10.5	15.5	10.5	55.0	10.5	15.5				
Max Q Clear Time (g_c+I1), s	3.2	55.8	11.8	6.8	2.2	9.6	5.8	9.9				
Green Ext Time (p_c), s	0.0	0.0	0.0	0.2	0.0	3.9	0.0	0.2				

Intersection Summary

HCM 6th Ctrl Delay	35.2
HCM 6th LOS	D

Notes

User approved pedestrian interval to be less than phase max green.

HCM 6th Signalized Intersection Summary

2: SW Boones Ferry Rd & SW Avery St

06/30/2021



Movement	EBL	EBT	EBR	WBL	WBT	WBR	NBL	NBT	NBR	SBL	SBT	SBR
Lane Configurations												
Traffic Volume (veh/h)	178	70	154	31	107	15	283	761	42	7	324	160
Future Volume (veh/h)	178	70	154	31	107	15	283	761	42	7	324	160
Initial Q (Qb), veh	0	0	0	0	0	0	0	0	0	0	0	0
Ped-Bike Adj(A_pbT)	1.00		0.97	0.99		0.96	1.00		0.98	1.00		1.00
Parking Bus, Adj	1.00	1.00	1.00	1.00	1.00	1.00	1.00	1.00	1.00	1.00	1.00	1.00
Work Zone On Approach		No			No			No			No	
Adj Sat Flow, veh/h/ln	1841	1841	1841	1841	1841	1841	1767	1767	1767	1841	1841	1841
Adj Flow Rate, veh/h	212	83	106	37	127	12	337	906	44	8	386	172
Peak Hour Factor	0.84	0.84	0.84	0.84	0.84	0.84	0.84	0.84	0.84	0.84	0.84	0.84
Percent Heavy Veh, %	4	4	4	4	4	4	9	9	9	4	4	4
Cap, veh/h	318	143	183	226	174	16	431	999	49	152	661	294
Arrive On Green	0.13	0.20	0.19	0.03	0.11	0.10	0.06	0.60	0.58	0.01	0.55	0.55
Sat Flow, veh/h	1753	721	921	1753	1649	156	1682	1669	81	1753	1205	537
Grp Volume(v), veh/h	212	0	189	37	0	139	337	0	950	8	0	558
Grp Sat Flow(s),veh/h/ln	1753	0	1642	1753	0	1805	1682	0	1750	1753	0	1742
Q Serve(g_s), s	10.4	0.0	10.4	1.9	0.0	7.4	6.0	0.0	47.5	0.2	0.0	21.2
Cycle Q Clear(g_c), s	10.4	0.0	10.4	1.9	0.0	7.4	6.0	0.0	47.5	0.2	0.0	21.2
Prop In Lane	1.00		0.56	1.00		0.09	1.00		0.05	1.00		0.31
Lane Grp Cap(c), veh/h	318	0	326	226	0	190	431	0	1047	152	0	955
V/C Ratio(X)	0.67	0.00	0.58	0.16	0.00	0.73	0.78	0.00	0.91	0.05	0.00	0.58
Avail Cap(c_a), veh/h	467	0	429	276	0	199	431	0	1160	240	0	1155
HCM Platoon Ratio	1.00	1.00	1.00	1.00	1.00	1.00	1.00	1.00	1.00	1.00	1.00	1.00
Upstream Filter(I)	1.00	0.00	1.00	1.00	0.00	1.00	1.00	0.00	1.00	1.00	0.00	1.00
Uniform Delay (d), s/veh	33.2	0.0	36.4	38.7	0.0	43.2	20.3	0.0	17.6	19.6	0.0	15.0
Incr Delay (d2), s/veh	0.9	0.0	0.6	0.1	0.0	10.4	8.2	0.0	10.1	0.1	0.0	0.8
Initial Q Delay(d3),s/veh	0.0	0.0	0.0	0.0	0.0	0.0	0.0	0.0	0.0	0.0	0.0	0.0
%ile BackOfQ(50%),veh/ln	4.4	0.0	4.2	0.8	0.0	3.8	5.4	0.0	20.1	0.1	0.0	8.1
Unsig. Movement Delay, s/veh												
LnGrp Delay(d),s/veh	34.1	0.0	37.0	38.9	0.0	53.7	28.5	0.0	27.7	19.7	0.0	15.8
LnGrp LOS	C	A	D	D	A	D	C	A	C	B	A	B
Approach Vol, veh/h		401			176			1287			566	
Approach Delay, s/veh		35.5			50.5			27.9			15.8	
Approach LOS		D			D			C			B	
Timer - Assigned Phs	1	2	3	4	5	6	7	8				
Phs Duration (G+Y+Rc), s	5.0	63.6	7.2	23.8	10.0	58.6	16.5	14.5				
Change Period (Y+Rc), s	4.0	5.5	4.0	5.0	4.0	5.5	4.0	5.0				
Max Green Setting (Gmax), s	6.0	64.5	6.0	25.0	6.0	64.5	21.0	10.0				
Max Q Clear Time (g_c+1/2), s	12.2	49.5	3.9	12.4	8.0	23.2	12.4	9.4				
Green Ext Time (p_c), s	0.0	8.6	0.0	0.6	0.0	6.5	0.1	0.0				

Intersection Summary

HCM 6th Ctrl Delay	28.0
HCM 6th LOS	C

Notes

User approved pedestrian interval to be less than phase max green.

HCM 6th Signalized Intersection Summary
 3: SW Boones Ferry Road & SW Ibach Street/SW Ibach Court

06/30/2021



Movement	EBL	EBT	EBR	WBL	WBT	WBR	NBL	NBT	NBR	SBL	SBT	SBR
Lane Configurations												
Traffic Volume (veh/h)	262	4	346	4	1	19	144	809	10	3	420	87
Future Volume (veh/h)	262	4	346	4	1	19	144	809	10	3	420	87
Initial Q (Qb), veh	0	0	0	0	0	0	0	0	0	0	0	0
Ped-Bike Adj(A_pbT)	0.98		0.99	1.00		0.97	1.00		0.99	1.00		0.99
Parking Bus, Adj	1.00	1.00	1.00	1.00	1.00	1.00	1.00	1.00	1.00	1.00	1.00	1.00
Work Zone On Approach		No			No		No		No		No	
Adj Sat Flow, veh/h/ln	1856	1856	1856	1900	1900	1900	1796	1796	1796	1811	1811	1811
Adj Flow Rate, veh/h	301	5	226	5	1	5	166	930	11	3	483	54
Peak Hour Factor	0.87	0.87	0.87	0.87	0.87	0.87	0.87	0.87	0.87	0.87	0.87	0.87
Percent Heavy Veh, %	3	3	3	0	0	0	7	7	7	6	6	6
Cap, veh/h	416	10	429	154	45	117	198	1029	12	6	848	715
Arrive On Green	0.28	0.28	0.28	0.28	0.28	0.28	0.12	0.58	0.57	0.00	0.47	0.47
Sat Flow, veh/h	1371	34	1530	339	161	417	1711	1771	21	1725	1811	1527
Grp Volume(v), veh/h	301	0	231	11	0	0	166	0	941	3	483	54
Grp Sat Flow(s),veh/h/ln	1371	0	1564	917	0	0	1711	0	1792	1725	1811	1527
Q Serve(g_s), s	10.9	0.0	11.1	0.1	0.0	0.0	8.4	0.0	41.1	0.2	17.1	1.7
Cycle Q Clear(g_c), s	22.1	0.0	11.1	11.2	0.0	0.0	8.4	0.0	41.1	0.2	17.1	1.7
Prop In Lane	1.00		0.98	0.45		0.45	1.00		0.01	1.00		1.00
Lane Grp Cap(c), veh/h	416	0	439	311	0	0	198	0	1041	6	848	715
V/C Ratio(X)	0.72	0.00	0.53	0.04	0.00	0.00	0.84	0.00	0.90	0.54	0.57	0.08
Avail Cap(c_a), veh/h	433	0	459	329	0	0	212	0	1132	214	1144	965
HCM Platoon Ratio	1.00	1.00	1.00	1.00	1.00	1.00	1.00	1.00	1.00	1.00	1.00	1.00
Upstream Filter(I)	1.00	0.00	1.00	1.00	0.00	0.00	1.00	0.00	1.00	1.00	1.00	1.00
Uniform Delay (d), s/veh	31.8	0.0	27.1	23.7	0.0	0.0	38.4	0.0	16.4	44.1	17.1	13.0
Incr Delay (d2), s/veh	5.1	0.0	0.6	0.0	0.0	0.0	22.3	0.0	10.3	42.0	1.0	0.1
Initial Q Delay(d3),s/veh	0.0	0.0	0.0	0.0	0.0	0.0	0.0	0.0	0.0	0.0	0.0	0.0
%ile BackOfQ(50%),veh/ln	6.7	0.0	4.1	0.2	0.0	0.0	4.7	0.0	17.3	0.1	6.8	0.6
Unsig. Movement Delay, s/veh												
LnGrp Delay(d),s/veh	36.9	0.0	27.8	23.7	0.0	0.0	60.7	0.0	26.7	86.1	18.1	13.1
LnGrp LOS	D	A	C	C	A	A	E	A	C	F	B	B
Approach Vol, veh/h		532			11			1107			540	
Approach Delay, s/veh		32.9			23.7			31.8			17.9	
Approach LOS		C			C			C			B	
Timer - Assigned Phs	1	2		4	5	6		8				
Phs Duration (G+Y+Rc), s	4.3	55.5		28.9	14.3	45.5		28.9				
Change Period (Y+Rc), s	4.0	5.0		4.5	4.0	5.0		4.5				
Max Green Setting (Gmax), s	1.0	55.0		25.5	11.0	55.0		25.5				
Max Q Clear Time (g_c+1/2), s	12.2	43.1		24.1	10.4	19.1		13.2				
Green Ext Time (p_c), s	0.0	7.4		0.3	0.0	5.8		0.0				
Intersection Summary												
HCM 6th Ctrl Delay											28.6	
HCM 6th LOS											C	

HCM 6th TWSC
4: SW Boones Ferry Road & SW Iowa Drive

06/30/2021

Intersection												
Int Delay, s/veh	16											
Movement	EBL	EBT	EBR	WBL	WBT	WBR	NBL	NBT	NBR	SBL	SBT	SBR
Lane Configurations		↕			↕		↕	↕		↕	↕	
Traffic Vol, veh/h	51	2	56	30	0	32	14	767	10	20	483	18
Future Vol, veh/h	51	2	56	30	0	32	14	767	10	20	483	18
Conflicting Peds, #/hr	13	0	5	1	0	9	5	0	1	9	0	13
Sign Control	Stop	Stop	Stop	Stop	Stop	Stop	Free	Free	Free	Free	Free	Free
RT Channelized	-	-	None	-	-	None	-	-	None	-	-	None
Storage Length	-	-	-	-	-	-	95	-	-	105	-	-
Veh in Median Storage, #	-	0	-	-	0	-	-	0	-	-	0	-
Grade, %	-	0	-	-	0	-	-	0	-	-	0	-
Peak Hour Factor	84	84	84	84	84	84	84	84	84	84	84	84
Heavy Vehicles, %	0	0	0	0	0	0	7	7	7	6	6	6
Mvmt Flow	61	2	67	36	0	38	17	913	12	24	575	21

Major/Minor	Minor2		Minor1		Major1			Major2				
Conflicting Flow All	1632	1615	604	1635	1619	941	609	0	0	934	0	0
Stage 1	647	647	-	962	962	-	-	-	-	-	-	-
Stage 2	985	968	-	673	657	-	-	-	-	-	-	-
Critical Hdwy	7.1	6.5	6.2	7.1	6.5	6.2	4.17	-	-	4.16	-	-
Critical Hdwy Stg 1	6.1	5.5	-	6.1	5.5	-	-	-	-	-	-	-
Critical Hdwy Stg 2	6.1	5.5	-	6.1	5.5	-	-	-	-	-	-	-
Follow-up Hdwy	3.5	4	3.3	3.5	4	3.3	2.263	-	-	2.254	-	-
Pot Cap-1 Maneuver	82	105	502	82	104	322	946	-	-	717	-	-
Stage 1	463	470	-	310	337	-	-	-	-	-	-	-
Stage 2	301	335	-	448	465	-	-	-	-	-	-	-
Platoon blocked, %								-	-	-	-	-
Mov Cap-1 Maneuver	68	98	493	66	97	315	934	-	-	711	-	-
Mov Cap-2 Maneuver	68	98	-	66	97	-	-	-	-	-	-	-
Stage 1	449	448	-	302	328	-	-	-	-	-	-	-
Stage 2	257	326	-	371	444	-	-	-	-	-	-	-

Approach	EB		WB		NB		SB	
HCM Control Delay, s	165.2		86.1		0.2		0.4	
HCM LOS	F		F					

Minor Lane/Major Mvmt	NBL	NBT	NBR	EBLn1WBLn1	SBL	SBT	SBR
Capacity (veh/h)	934	-	-	123	111	711	-
HCM Lane V/C Ratio	0.018	-	-	1.055	0.665	0.033	-
HCM Control Delay (s)	8.9	-	-	165.2	86.1	10.2	-
HCM Lane LOS	A	-	-	F	F	B	-
HCM 95th %tile Q(veh)	0.1	-	-	7.4	3.4	0.1	-

HCM 6th TWSC
 5: SW Boones Ferry Road & SW Norwood Road

06/30/2021

Intersection						
Int Delay, s/veh	5.8					
Movement	WBL	WBR	NBT	NBR	SBL	SBT
Lane Configurations	Y		↑	↑	↑	↑
Traffic Vol, veh/h	89	102	690	40	67	502
Future Vol, veh/h	89	102	690	40	67	502
Conflicting Peds, #/hr	4	4	0	4	4	0
Sign Control	Stop	Stop	Free	Free	Free	Free
RT Channelized	-	None	-	None	-	None
Storage Length	-	-	-	65	290	-
Veh in Median Storage, #	0	-	0	-	-	0
Grade, %	0	-	0	-	-	0
Peak Hour Factor	87	87	87	87	87	87
Heavy Vehicles, %	2	2	6	6	5	5
Mvmt Flow	102	117	793	46	77	577

Major/Minor	Minor1	Major1	Major2		
Conflicting Flow All	1532	801	0	0	843
Stage 1	797	-	-	-	-
Stage 2	735	-	-	-	-
Critical Hdwy	6.42	6.22	-	-	4.15
Critical Hdwy Stg 1	5.42	-	-	-	-
Critical Hdwy Stg 2	5.42	-	-	-	-
Follow-up Hdwy	3.518	3.318	-	-	2.245
Pot Cap-1 Maneuver	128	384	-	-	780
Stage 1	444	-	-	-	-
Stage 2	474	-	-	-	-
Platoon blocked, %			-	-	-
Mov Cap-1 Maneuver	114	381	-	-	777
Mov Cap-2 Maneuver	250	-	-	-	-
Stage 1	442	-	-	-	-
Stage 2	426	-	-	-	-

Approach	WB	NB	SB
HCM Control Delay, s	41.7	0	1.2
HCM LOS	E		

Minor Lane/Major Mvmt	NBT	NBRWBLn1	SBL	SBT
Capacity (veh/h)	-	-	306	777
HCM Lane V/C Ratio	-	-	0.717	0.099
HCM Control Delay (s)	-	-	41.7	10.1
HCM Lane LOS	-	-	E	B
HCM 95th %tile Q(veh)	-	-	5.2	0.3

HCM 6th TWSC
6: SW Boones Ferry Road & Site Access

09/20/2021

Intersection						
Int Delay, s/veh	2.1					
Movement	WBL	WBR	NBT	NBR	SBL	SBT
Lane Configurations	↘	↗	↑	↗	↘	↑
Traffic Vol, veh/h	96	58	677	32	17	574
Future Vol, veh/h	96	58	677	32	17	574
Conflicting Peds, #/hr	4	4	0	4	4	0
Sign Control	Stop	Stop	Free	Free	Free	Free
RT Channelized	-	None	-	None	-	None
Storage Length	-	150	-	150	150	-
Veh in Median Storage, #	2	-	0	-	-	0
Grade, %	0	-	0	-	-	0
Peak Hour Factor	87	87	87	87	87	87
Heavy Vehicles, %	0	0	6	6	5	5
Mvmt Flow	110	67	778	37	20	660

Major/Minor	Minor1	Major1	Major2		
Conflicting Flow All	1486	786	0	0	819
Stage 1	782	-	-	-	-
Stage 2	704	-	-	-	-
Critical Hdwy	6.4	6.2	-	-	4.15
Critical Hdwy Stg 1	5.4	-	-	-	-
Critical Hdwy Stg 2	5.4	-	-	-	-
Follow-up Hdwy	3.5	3.3	-	-	2.245
Pot Cap-1 Maneuver	139	395	-	-	797
Stage 1	454	-	-	-	-
Stage 2	494	-	-	-	-
Platoon blocked, %			-	-	-
Mov Cap-1 Maneuver	134	392	-	-	794
Mov Cap-2 Maneuver	337	-	-	-	-
Stage 1	452	-	-	-	-
Stage 2	480	-	-	-	-

Approach	WB	NB	SB
HCM Control Delay, s	19	0	0.3
HCM LOS	C		

Minor Lane/Major Mvmt	NBT	NBRWBLn1	WBLn2	SBL	SBT
Capacity (veh/h)	-	-	337	392	794
HCM Lane V/C Ratio	-	-	0.327	0.17	0.025
HCM Control Delay (s)	-	-	20.8	16.1	9.6
HCM Lane LOS	-	-	C	C	A
HCM 95th %tile Q(veh)	-	-	1.4	0.6	0.1

HCM 6th TWSC
7: SW Boones Ferry Road & SW Greenhill Lane

06/30/2021

Intersection						
Int Delay, s/veh	0					
Movement	WBL	WBR	NBT	NBR	SBL	SBT
Lane Configurations						
Traffic Vol, veh/h	2	1	706	0	0	669
Future Vol, veh/h	2	1	706	0	0	669
Conflicting Peds, #/hr	4	4	0	4	4	0
Sign Control	Stop	Stop	Free	Free	Free	Free
RT Channelized	-	None	-	None	-	None
Storage Length	-	-	-	-	150	-
Veh in Median Storage, #	2	-	0	-	-	0
Grade, %	0	-	0	-	-	0
Peak Hour Factor	87	87	87	87	87	87
Heavy Vehicles, %	0	0	6	6	5	5
Mvmt Flow	2	1	811	0	0	769

Major/Minor	Minor1	Major1	Major2		
Conflicting Flow All	1588	819	0	0	815
Stage 1	815	-	-	-	-
Stage 2	773	-	-	-	-
Critical Hdwy	6.4	6.2	-	-	4.15
Critical Hdwy Stg 1	5.4	-	-	-	-
Critical Hdwy Stg 2	5.4	-	-	-	-
Follow-up Hdwy	3.5	3.3	-	-	2.245
Pot Cap-1 Maneuver	120	379	-	-	799
Stage 1	439	-	-	-	-
Stage 2	459	-	-	-	-
Platoon blocked, %			-	-	-
Mov Cap-1 Maneuver	119	376	-	-	796
Mov Cap-2 Maneuver	320	-	-	-	-
Stage 1	437	-	-	-	-
Stage 2	457	-	-	-	-

Approach	WB	NB	SB
HCM Control Delay, s	15.8	0	0
HCM LOS	C		

Minor Lane/Major Mvmt	NBT	NBRWBLn1	SBL	SBT
Capacity (veh/h)	-	-	337	796
HCM Lane V/C Ratio	-	-	0.01	-
HCM Control Delay (s)	-	-	15.8	0
HCM Lane LOS	-	-	C	A
HCM 95th %tile Q(veh)	-	-	0	0

HCM 6th Signalized Intersection Summary

8: SW Boones Ferry Road & SW Day Road

06/30/2021



Movement	EBL	EBT	EBR	WBL	WBT	WBR	NBL	NBT	NBR	SBL	SBT	SBR
Lane Configurations		↖	↗		↔		↖	↗		↖	↗	
Traffic Volume (veh/h)	186	0	581	0	0	0	642	520	0	0	594	76
Future Volume (veh/h)	186	0	581	0	0	0	642	520	0	0	594	76
Initial Q (Qb), veh	0	0	0	0	0	0	0	0	0	0	0	0
Ped-Bike Adj(A_pbT)	1.00		1.00	1.00		1.00	1.00		1.00	1.00		1.00
Parking Bus, Adj	1.00	1.00	1.00	1.00	1.00	1.00	1.00	1.00	1.00	1.00	1.00	1.00
Work Zone On Approach		No			No			No			No	
Adj Sat Flow, veh/h/ln	1693	1693	1693	1900	1900	1900	1693	1693	1693	1796	1796	1796
Adj Flow Rate, veh/h	207	0	596	0	0	0	713	578	0	0	660	73
Peak Hour Factor	0.90	0.90	0.90	0.90	0.90	0.90	0.90	0.90	0.90	0.90	0.90	0.90
Percent Heavy Veh, %	14	14	14	0	0	0	14	14	14	7	7	7
Cap, veh/h	285	0	661	0	316	0	807	712	0	471	1250	138
Arrive On Green	0.16	0.00	0.17	0.00	0.00	0.00	0.20	0.28	0.00	0.00	0.40	0.39
Sat Flow, veh/h	1283	0	1434	0	1900	0	2740	1693	0	1711	3099	342
Grp Volume(v), veh/h	207	0	596	0	0	0	713	578	0	0	363	370
Grp Sat Flow(s),veh/h/ln	1283	0	1434	0	1900	0	1370	1693	0	1711	1706	1735
Q Serve(g_s), s	15.3	0.0	15.8	0.0	0.0	0.0	24.0	30.2	0.0	0.0	15.3	15.4
Cycle Q Clear(g_c), s	15.3	0.0	15.8	0.0	0.0	0.0	24.0	30.2	0.0	0.0	15.3	15.4
Prop In Lane	1.00		1.00	0.00		0.00	1.00		0.00	1.00		0.20
Lane Grp Cap(c), veh/h	282	0	661	0	316	0	807	712	0	471	688	700
V/C Ratio(X)	0.73	0.00	0.90	0.00	0.00	0.00	0.88	0.81	0.00	0.00	0.53	0.53
Avail Cap(c_a), veh/h	282	0	661	0	320	0	1047	1033	0	471	688	700
HCM Platoon Ratio	1.00	1.00	1.00	1.00	1.00	1.00	0.67	0.67	0.67	1.00	1.00	1.00
Upstream Filter(I)	1.00	0.00	1.00	0.00	0.00	0.00	0.89	0.89	0.00	0.00	1.00	1.00
Uniform Delay (d), s/veh	39.8	0.0	23.6	0.0	0.0	0.0	36.5	30.6	0.0	0.0	21.5	21.6
Incr Delay (d2), s/veh	9.0	0.0	15.4	0.0	0.0	0.0	6.0	8.8	0.0	0.0	2.9	2.8
Initial Q Delay(d3),s/veh	0.0	0.0	0.0	0.0	0.0	0.0	0.0	0.0	0.0	0.0	0.0	0.0
%ile BackOfQ(50%),veh/ln	5.4	0.0	13.9	0.0	0.0	0.0	8.9	14.4	0.0	0.0	6.2	6.3
Unsig. Movement Delay, s/veh												
LnGrp Delay(d),s/veh	48.8	0.0	39.1	0.0	0.0	0.0	42.6	39.4	0.0	0.0	24.4	24.5
LnGrp LOS	D	A	D	A	A	A	D	D	A	A	C	C
Approach Vol, veh/h		803			0			1291			733	
Approach Delay, s/veh		41.6			0.0			41.2			24.4	
Approach LOS		D						D			C	
Timer - Assigned Phs	1	2		4	5	6		8				
Phs Duration (G+Y+Rc), s	32.7	42.3		20.0	31.1	43.9		20.0				
Change Period (Y+Rc), s	5.2	* 5.4		* 4.7	* 5.4	* 5.4		* 4.7				
Max Green Setting (Gmax), s	35.8	* 29		* 16	* 8.5	* 57		* 15				
Max Q Clear Time (g_c+I1), s	26.0	17.4		0.0	0.0	32.2		17.8				
Green Ext Time (p_c), s	1.5	4.7		0.0	0.0	6.3		0.0				

Intersection Summary

HCM 6th Ctrl Delay	36.9
HCM 6th LOS	D

Notes

User approved pedestrian interval to be less than phase max green.

* HCM 6th computational engine requires equal clearance times for the phases crossing the barrier.

HCM 6th Signalized Intersection Summary

9: SW Elligsen Road/SW Boones Ferry Road & SW 95th Avenue

06/30/2021



Movement	EBL	EBT	EBR	WBL	WBT	WBR	NBL	NBT	NBR	SBL	SBT	SBR
Lane Configurations		↕	↗	↖	↗	↖	↗	↖		↖	↗	↖
Traffic Volume (veh/h)	208	8	560	17	1	7	846	866	70	6	814	273
Future Volume (veh/h)	208	8	560	17	1	7	846	866	70	6	814	273
Initial Q (Qb), veh	0	0	0	0	0	0	0	0	0	0	0	0
Ped-Bike Adj(A_pbT)	1.00		0.99	1.00		1.00	1.00		1.00	1.00		1.00
Parking Bus, Adj	1.00	1.00	1.00	1.00	1.00	1.00	1.00	1.00	1.00	1.00	1.00	1.00
Work Zone On Approach		No		No		No		No		No		No
Adj Sat Flow, veh/h/ln	1648	1648	1648	1737	1737	1737	1796	1796	1796	1737	1737	1737
Adj Flow Rate, veh/h	226	9	571	18	1	8	920	941	76	7	885	0
Peak Hour Factor	0.92	0.92	0.92	0.92	0.92	0.92	0.92	0.92	0.92	0.92	0.92	0.92
Percent Heavy Veh, %	17	17	17	11	11	11	7	7	7	11	11	11
Cap, veh/h	296	9	1222	76	31	251	1025	1233	100	442	1135	
Arrive On Green	0.19	0.19	0.19	0.19	0.19	0.19	0.52	0.64	0.64	0.09	0.11	0.00
Sat Flow, veh/h	1168	47	2445	775	166	1327	3319	3198	258	1654	3300	1472
Grp Volume(v), veh/h	235	0	571	18	0	9	920	502	515	7	885	0
Grp Sat Flow(s),veh/h/ln	1215	0	1223	775	0	1493	1659	1706	1749	1654	1650	1472
Q Serve(g_s), s	17.5	0.0	14.5	0.0	0.0	0.5	23.8	19.6	19.6	0.4	24.8	0.0
Cycle Q Clear(g_c), s	18.0	0.0	14.5	18.0	0.0	0.5	23.8	19.6	19.6	0.4	24.8	0.0
Prop In Lane	0.96		1.00	1.00		0.89	1.00		0.15	1.00		1.00
Lane Grp Cap(c), veh/h	304	0	1222	76	0	283	1025	658	675	442	1135	
V/C Ratio(X)	0.77	0.00	0.47	0.24	0.00	0.03	0.90	0.76	0.76	0.02	0.78	
Avail Cap(c_a), veh/h	304	0	1222	76	0	283	1572	988	1013	442	1135	
HCM Platoon Ratio	1.00	1.00	1.00	1.00	1.00	1.00	1.67	1.67	1.67	0.33	0.33	0.33
Upstream Filter(I)	1.00	0.00	1.00	1.00	0.00	1.00	0.19	0.19	0.19	0.64	0.64	0.00
Uniform Delay (d), s/veh	38.9	0.0	15.6	47.5	0.0	31.4	21.7	13.9	13.9	31.9	38.6	0.0
Incr Delay (d2), s/veh	11.1	0.0	0.2	1.2	0.0	0.0	1.0	1.6	1.6	0.0	3.5	0.0
Initial Q Delay(d3),s/veh	0.0	0.0	0.0	0.0	0.0	0.0	0.0	0.0	0.0	0.0	0.0	0.0
%ile BackOfQ(50%),veh/ln	6.3	0.0	3.9	0.4	0.0	0.2	6.6	4.9	5.0	0.1	11.4	0.0
Unsig. Movement Delay, s/veh												
LnGrp Delay(d),s/veh	50.0	0.0	15.8	48.7	0.0	31.4	22.7	15.5	15.5	31.9	42.1	0.0
LnGrp LOS	D	A	B	D	A	C	C	B	B	C	D	
Approach Vol, veh/h		806			27			1937			892	A
Approach Delay, s/veh		25.8			42.9			18.9			42.0	
Approach LOS		C			D			B			D	
Timer - Assigned Phs	1	2		4	5	6		8				
Phs Duration (G+Y+Rc), s	34.3	37.7		23.0	30.4	41.6		23.0				
Change Period (Y+Rc), s	5.0	5.0		5.0	5.0	5.0		5.0				
Max Green Setting (Gmax), s	45.0	17.0		18.0	7.0	55.0		18.0				
Max Q Clear Time (g_c+Q), s	25.8	26.8		20.0	2.4	21.6		20.0				
Green Ext Time (p_c), s	3.6	0.0		0.0	0.0	15.1		0.0				

Intersection Summary

HCM 6th Ctrl Delay	26.2
HCM 6th LOS	C

Notes

User approved pedestrian interval to be less than phase max green.

Unsignalized Delay for [SBR] is excluded from calculations of the approach delay and intersection delay.

HCM Signalized Intersection Capacity Analysis

10: I-5 SB Ramps & SW Elligsen Road

06/24/2021



Movement	EBL	EBT	EBR	WBL	WBT	WBR	NBL	NBT	NBR	SBL	SBT	SBR		
Lane Configurations		↑↑	↗		↑↑	↗				↘	↖	↗		
Traffic Volume (vph)	0	1011	379	0	755	121	0	0	0	540	0	1025		
Future Volume (vph)	0	1011	379	0	755	121	0	0	0	540	0	1025		
Ideal Flow (vphpl)	1900	1900	1900	1900	1900	1900	1900	1900	1900	1900	1900	1900		
Lane Width	12	12	12	12	12	12	12	12	12	12	12	16		
Total Lost time (s)		4.0	4.0		4.0	4.0				4.0	4.0	4.0		
Lane Util. Factor		0.95	1.00		0.95	1.00				0.95	0.95	1.00		
Frbp, ped/bikes		1.00	0.99		1.00	1.00				1.00	1.00	1.00		
Flpb, ped/bikes		1.00	1.00		1.00	1.00				1.00	1.00	1.00		
Frt		1.00	0.85		1.00	0.85				1.00	1.00	0.85		
Flt Protected		1.00	1.00		1.00	1.00				0.95	0.95	1.00		
Satd. Flow (prot)		3034	1340		3406	1524				1573	1573	1679		
Flt Permitted		1.00	1.00		1.00	1.00				0.95	0.95	1.00		
Satd. Flow (perm)		3034	1340		3406	1524				1573	1573	1679		
Peak-hour factor, PHF	0.94	0.94	0.94	0.94	0.94	0.94	0.94	0.94	0.94	0.94	0.94	0.94		
Adj. Flow (vph)	0	1076	403	0	803	129	0	0	0	574	0	1090		
RTOR Reduction (vph)	0	0	0	0	0	0	0	0	0	0	0	9		
Lane Group Flow (vph)	0	1076	403	0	803	129	0	0	0	287	287	1081		
Confl. Peds. (#/hr)			2											
Heavy Vehicles (%)	19%	19%	19%	6%	6%	6%	0%	0%	0%	9%	9%	9%		
Turn Type		NA	Free		NA	Free				Split	NA	custom		
Protected Phases		2			6					4	4	5		
Permitted Phases			Free		6	Free						4		
Actuated Green, G (s)		65.1	95.0		22.7	95.0				20.4	20.4	58.3		
Effective Green, g (s)		66.1	95.0		23.7	95.0				20.9	20.9	59.3		
Actuated g/C Ratio		0.70	1.00		0.25	1.00				0.22	0.22	0.62		
Clearance Time (s)		5.0			5.0					4.5	4.5	4.5		
Vehicle Extension (s)		4.1			4.1					2.3	2.3	2.3		
Lane Grp Cap (vph)		2111	1340		849	1524				346	346	1118		
v/s Ratio Prot		0.35			c0.24					0.18	0.18	c0.39		
v/s Ratio Perm			0.30			0.08						0.25		
v/c Ratio		0.51	0.30		0.95	0.08				0.83	0.83	0.97		
Uniform Delay, d1		6.8	0.0		35.0	0.0				35.3	35.3	16.9		
Progression Factor		2.36	1.00		0.62	1.00				1.00	1.00	1.00		
Incremental Delay, d2		0.6	0.4		18.6	0.1				14.6	14.6	19.2		
Delay (s)		16.7	0.4		40.1	0.1				50.0	50.0	36.2		
Level of Service		B	A		D	A				D	D	D		
Approach Delay (s)		12.3			34.6			0.0			40.9			
Approach LOS		B			C			A			D			
Intersection Summary														
HCM 2000 Control Delay			29.1									HCM 2000 Level of Service	C	
HCM 2000 Volume to Capacity ratio			1.01											
Actuated Cycle Length (s)			95.0							12.0			Sum of lost time (s)	
Intersection Capacity Utilization			91.0%										ICU Level of Service	F
Analysis Period (min)			15											
c Critical Lane Group														

V/C Ratio calculated using HCM worksheet with correct lost time

HCM 6th Signalized Intersection Summary

11: I-5 NB Ramps & SW Elligsen Road

06/30/2021

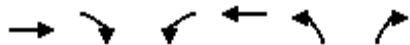

Movement	EBT	EBR	WBL	WBT	NBL	NBR
Lane Configurations	↑↑	↑		↑↑	↑↑	↑
Traffic Volume (veh/h)	784	768	0	342	533	265
Future Volume (veh/h)	784	768	0	342	533	265
Initial Q (Qb), veh	0	0	0	0	0	0
Ped-Bike Adj(A_pbT)		1.00	1.00		1.00	1.00
Parking Bus, Adj	1.00	1.00	1.00	1.00	1.00	1.00
Work Zone On Approach	No			No	No	
Adj Sat Flow, veh/h/ln	1707	1707	0	1796	1811	1811
Adj Flow Rate, veh/h	862	0	0	376	586	0
Peak Hour Factor	0.91	0.91	0.91	0.91	0.91	0.91
Percent Heavy Veh, %	13	13	0	7	6	6
Cap, veh/h	2311		0	2432	680	
Arrive On Green	0.24	0.00	0.00	0.71	0.20	0.00
Sat Flow, veh/h	3329	1447	0	3593	3346	1535
Grp Volume(v), veh/h	862	0	0	376	586	0
Grp Sat Flow(s),veh/h/ln	1622	1447	0	1706	1673	1535
Q Serve(g_s), s	21.2	0.0	0.0	3.4	16.1	0.0
Cycle Q Clear(g_c), s	21.2	0.0	0.0	3.4	16.1	0.0
Prop In Lane		1.00	0.00		1.00	1.00
Lane Grp Cap(c), veh/h	2311		0	2432	680	
V/C Ratio(X)	0.37		0.00	0.15	0.86	
Avail Cap(c_a), veh/h	2311		0	2432	810	
HCM Platoon Ratio	0.33	0.33	1.00	1.00	1.00	1.00
Upstream Filter(I)	0.79	0.00	0.00	1.00	1.00	0.00
Uniform Delay (d), s/veh	18.5	0.0	0.0	4.4	36.6	0.0
Incr Delay (d2), s/veh	0.4	0.0	0.0	0.1	7.6	0.0
Initial Q Delay(d3),s/veh	0.0	0.0	0.0	0.0	0.0	0.0
%ile BackOfQ(50%),veh/ln	0.2	0.0	0.0	1.0	7.2	0.0
Unsig. Movement Delay, s/veh						
LnGrp Delay(d),s/veh	18.9	0.0	0.0	4.5	44.2	0.0
LnGrp LOS	B		A	A	D	
Approach Vol, veh/h	862	A		376	586	A
Approach Delay, s/veh	18.9			4.5	44.2	
Approach LOS	B			A	D	
Timer - Assigned Phs		2		6	8	
Phs Duration (G+Y+Rc), s		71.7		71.7	23.3	
Change Period (Y+Rc), s		5.0		5.0	4.5	
Max Green Setting (Gmax), s		63.0		63.0	22.5	
Max Q Clear Time (g_c+I1), s		23.2		5.4	18.1	
Green Ext Time (p_c), s		10.7		4.0	0.7	

Intersection Summary

HCM 6th Ctrl Delay	24.1
HCM 6th LOS	C

Notes

Unsignalized Delay for [NBR, EBR] is excluded from calculations of the approach delay and intersection delay.

HCM 6th TWSC
 12: Site Access/SW 89th Avenue & SW Norwood Road

06/30/2021

Intersection												
Int Delay, s/veh	2.3											
Movement	EBL	EBT	EBR	WBL	WBT	WBR	NBL	NBT	NBR	SBL	SBT	SBR
Lane Configurations		↕			↕			↕			↕	
Traffic Vol, veh/h	14	121	7	1	179	2	20	0	4	19	0	26
Future Vol, veh/h	14	121	7	1	179	2	20	0	4	19	0	26
Conflicting Peds, #/hr	1	0	0	0	0	2	0	0	0	2	0	1
Sign Control	Free	Free	Free	Free	Free	Free	Stop	Stop	Stop	Stop	Stop	Stop
RT Channelized	-	-	None	-	-	None	-	-	None	-	-	None
Storage Length	-	-	-	-	-	-	-	-	-	-	-	-
Veh in Median Storage, #	-	0	-	-	0	-	-	0	-	-	0	-
Grade, %	-	0	-	-	0	-	-	0	-	-	0	-
Peak Hour Factor	80	80	80	80	80	80	80	80	80	80	80	80
Heavy Vehicles, %	0	0	2	2	2	2	2	2	2	0	2	0
Mvmt Flow	18	151	9	1	224	3	25	0	5	24	0	33

Major/Minor	Major1			Major2			Minor1			Minor2		
Conflicting Flow All	229	0	0	160	0	0	437	423	158	426	426	229
Stage 1	-	-	-	-	-	-	192	192	-	230	230	-
Stage 2	-	-	-	-	-	-	245	231	-	196	196	-
Critical Hdwy	4.1	-	-	4.12	-	-	7.12	6.52	6.22	7.1	6.52	6.2
Critical Hdwy Stg 1	-	-	-	-	-	-	6.12	5.52	-	6.1	5.52	-
Critical Hdwy Stg 2	-	-	-	-	-	-	6.12	5.52	-	6.1	5.52	-
Follow-up Hdwy	2.2	-	-	2.218	-	-	3.518	4.018	3.318	3.5	4.018	3.3
Pot Cap-1 Maneuver	1351	-	-	1419	-	-	530	522	887	542	520	815
Stage 1	-	-	-	-	-	-	810	742	-	777	714	-
Stage 2	-	-	-	-	-	-	759	713	-	810	739	-
Platoon blocked, %	-	-	-	-	-	-	-	-	-	-	-	-
Mov Cap-1 Maneuver	1348	-	-	1419	-	-	502	513	885	530	511	813
Mov Cap-2 Maneuver	-	-	-	-	-	-	502	513	-	530	511	-
Stage 1	-	-	-	-	-	-	798	731	-	764	712	-
Stage 2	-	-	-	-	-	-	727	711	-	792	728	-

Approach	EB	WB	NB	SB
HCM Control Delay, s	0.8	0	12	10.9
HCM LOS			B	B

Minor Lane/Major Mvmt	NBLn1	EBL	EBT	EBR	WBL	WBT	WBR	SBLn1
Capacity (veh/h)	541	1348	-	-	1419	-	-	663
HCM Lane V/C Ratio	0.055	0.013	-	-	0.001	-	-	0.085
HCM Control Delay (s)	12	7.7	0	-	7.5	0	-	10.9
HCM Lane LOS	B	A	A	-	A	A	-	B
HCM 95th %tile Q(veh)	0.2	0	-	-	0	-	-	0.3

Intersection												
Int Delay, s/veh	4.4											
Movement	EBL	EBT	EBR	WBL	WBT	WBR	NBL	NBT	NBR	SBL	SBT	SBR
Lane Configurations		↕			↕			↕			↕	
Traffic Vol, veh/h	21	111	11	8	106	7	31	0	26	40	0	45
Future Vol, veh/h	21	111	11	8	106	7	31	0	26	40	0	45
Conflicting Peds, #/hr	0	0	0	0	0	0	0	0	0	0	0	0
Sign Control	Free	Free	Free	Free	Free	Free	Stop	Stop	Stop	Stop	Stop	Stop
RT Channelized	-	-	None	-	-	None	-	-	None	-	-	None
Storage Length	-	-	-	-	-	-	-	-	-	-	-	-
Veh in Median Storage, #	-	0	-	-	0	-	-	0	-	-	0	-
Grade, %	-	0	-	-	0	-	-	0	-	-	0	-
Peak Hour Factor	81	81	81	81	81	81	81	81	81	81	81	81
Heavy Vehicles, %	0	0	2	2	3	3	2	2	2	0	2	0
Mvmt Flow	26	137	14	10	131	9	38	0	32	49	0	56

Major/Minor	Major1			Major2			Minor1			Minor2		
Conflicting Flow All	140	0	0	151	0	0	380	356	144	368	359	136
Stage 1	-	-	-	-	-	-	196	196	-	156	156	-
Stage 2	-	-	-	-	-	-	184	160	-	212	203	-
Critical Hdwy	4.1	-	-	4.12	-	-	7.12	6.52	6.22	7.1	6.52	6.2
Critical Hdwy Stg 1	-	-	-	-	-	-	6.12	5.52	-	6.1	5.52	-
Critical Hdwy Stg 2	-	-	-	-	-	-	6.12	5.52	-	6.1	5.52	-
Follow-up Hdwy	2.2	-	-	2.218	-	-	3.518	4.018	3.318	3.5	4.018	3.3
Pot Cap-1 Maneuver	1456	-	-	1430	-	-	578	570	903	592	568	918
Stage 1	-	-	-	-	-	-	806	739	-	851	769	-
Stage 2	-	-	-	-	-	-	818	766	-	795	733	-
Platoon blocked, %	-	-	-	-	-	-	-	-	-	-	-	-
Mov Cap-1 Maneuver	1456	-	-	1430	-	-	532	554	903	559	552	918
Mov Cap-2 Maneuver	-	-	-	-	-	-	532	554	-	559	552	-
Stage 1	-	-	-	-	-	-	790	724	-	834	763	-
Stage 2	-	-	-	-	-	-	762	760	-	751	718	-

Approach	EB			WB			NB			SB		
HCM Control Delay, s	1.1			0.5			11.2			11		
HCM LOS							B			B		

Minor Lane/Major Mvmt	NBLn1	EBL	EBT	EBR	WBL	WBT	WBR	SBLn1
Capacity (veh/h)	655	1456	-	-	1430	-	-	705
HCM Lane V/C Ratio	0.107	0.018	-	-	0.007	-	-	0.149
HCM Control Delay (s)	11.2	7.5	0	-	7.5	0	-	11
HCM Lane LOS	B	A	A	-	A	A	-	B
HCM 95th %tile Q(veh)	0.4	0.1	-	-	0	-	-	0.5

HCM 6th TWSC
 14: SW 82nd Avenue & SW Norwood Road/Driveway

06/30/2021

Intersection												
Int Delay, s/veh	7.5											
Movement	EBL	EBT	EBR	WBL	WBT	WBR	NBL	NBT	NBR	SBL	SBT	SBR
Lane Configurations		↕			↕			↕			↕	↗
Traffic Vol, veh/h	152	0	25	0	0	0	37	4	0	0	0	84
Future Vol, veh/h	152	0	25	0	0	0	37	4	0	0	0	84
Conflicting Peds, #/hr	0	0	0	0	0	0	0	0	0	0	0	0
Sign Control	Free	Free	Free	Free	Free	Free	Stop	Stop	Stop	Stop	Stop	Stop
RT Channelized	-	-	None	-	-	None	-	-	None	-	-	Free
Storage Length	-	-	-	-	-	-	-	-	-	-	-	15
Veh in Median Storage, #	-	0	-	-	0	-	-	0	-	-	0	-
Grade, %	-	0	-	-	0	-	-	0	-	-	0	-
Peak Hour Factor	89	89	89	89	89	89	89	89	89	89	89	89
Heavy Vehicles, %	2	2	2	0	0	0	6	6	6	10	10	10
Mvmt Flow	171	0	28	0	0	0	42	4	0	0	0	94

Major/Minor	Major1			Major2			Minor1			Minor2		
Conflicting Flow All	1	0	0	28	0	0	357	357	14	359	371	-
Stage 1	-	-	-	-	-	-	356	356	-	1	1	-
Stage 2	-	-	-	-	-	-	1	1	-	358	370	-
Critical Hdwy	4.12	-	-	4.1	-	-	7.16	6.56	6.26	7.2	6.6	-
Critical Hdwy Stg 1	-	-	-	-	-	-	6.16	5.56	-	6.2	5.6	-
Critical Hdwy Stg 2	-	-	-	-	-	-	6.16	5.56	-	6.2	5.6	-
Follow-up Hdwy	2.218	-	-	2.2	-	-	3.554	4.054	3.354	3.59	4.09	-
Pot Cap-1 Maneuver	1622	-	-	1599	-	-	591	563	1054	582	546	0
Stage 1	-	-	-	-	-	-	653	622	-	1002	879	0
Stage 2	-	-	-	-	-	-	1012	887	-	644	606	0
Platoon blocked, %	-	-	-	-	-	-	-	-	-	-	-	-
Mov Cap-1 Maneuver	1622	-	-	1599	-	-	543	503	1054	531	488	-
Mov Cap-2 Maneuver	-	-	-	-	-	-	543	503	-	531	488	-
Stage 1	-	-	-	-	-	-	583	555	-	895	879	-
Stage 2	-	-	-	-	-	-	1012	887	-	570	541	-

Approach	EB			WB			NB			SB		
HCM Control Delay, s	6.4			0			12.3			0		
HCM LOS							B			A		

Minor Lane/Major Mvmt	NBLn1	EBL	EBT	EBR	WBL	WBT	WBR	SBLn1	SBLn2
Capacity (veh/h)	539	1622	-	-	1599	-	-	-	-
HCM Lane V/C Ratio	0.085	0.105	-	-	-	-	-	-	-
HCM Control Delay (s)	12.3	7.5	0	-	0	-	-	0	0
HCM Lane LOS	B	A	A	-	A	-	-	A	A
HCM 95th %tile Q(veh)	0.3	0.4	-	-	0	-	-	-	-

HCM 6th TWSC
 15: SW 65th Avenue & SW Norwood Road

06/30/2021

Intersection						
Int Delay, s/veh	6.7					
Movement	EBL	EBR	NBL	NBT	SBT	SBR
Lane Configurations	T			T		
Traffic Vol, veh/h	154	62	42	351	244	69
Future Vol, veh/h	154	62	42	351	244	69
Conflicting Peds, #/hr	2	2	2	0	0	2
Sign Control	Stop	Stop	Free	Free	Free	Free
RT Channelized	-	None	-	None	-	None
Storage Length	-	-	-	-	-	-
Veh in Median Storage, #	0	-	-	0	0	-
Grade, %	0	-	-	0	0	-
Peak Hour Factor	90	90	90	90	90	90
Heavy Vehicles, %	2	2	2	2	6	6
Mvmt Flow	171	69	47	390	271	77

Major/Minor	Minor2	Major1		Major2	
Conflicting Flow All	798	314	350	0	0
Stage 1	312	-	-	-	-
Stage 2	486	-	-	-	-
Critical Hdwy	6.42	6.22	4.12	-	-
Critical Hdwy Stg 1	5.42	-	-	-	-
Critical Hdwy Stg 2	5.42	-	-	-	-
Follow-up Hdwy	3.518	3.318	2.218	-	-
Pot Cap-1 Maneuver	355	726	1209	-	-
Stage 1	742	-	-	-	-
Stage 2	618	-	-	-	-
Platoon blocked, %				-	-
Mov Cap-1 Maneuver	336	723	1207	-	-
Mov Cap-2 Maneuver	336	-	-	-	-
Stage 1	703	-	-	-	-
Stage 2	617	-	-	-	-

Approach	EB	NB	SB
HCM Control Delay, s	27	0.9	0
HCM LOS	D		

Minor Lane/Major Mvmt	NBL	NBT	EBLn1	SBT	SBR
Capacity (veh/h)	1207	-	397	-	-
HCM Lane V/C Ratio	0.039	-	0.605	-	-
HCM Control Delay (s)	8.1	0	27	-	-
HCM Lane LOS	A	A	D	-	-
HCM 95th %tile Q(veh)	0.1	-	3.8	-	-

HCM 6th Signalized Intersection Summary
 1: SW Boones Ferry Rd & SW Sagert St

06/30/2021



Movement	EBL	EBT	EBR	WBL	WBT	WBR	NBL	NBT	NBR	SBL	SBT	SBR
Lane Configurations												
Traffic Volume (veh/h)	56	173	10	250	98	43	22	400	318	90	689	61
Future Volume (veh/h)	56	173	10	250	98	43	22	400	318	90	689	61
Initial Q (Qb), veh	0	0	0	0	0	0	0	0	0	0	0	0
Ped-Bike Adj(A_pbT)	0.99		0.99	1.00		1.00	1.00		0.98	1.00		0.98
Parking Bus, Adj	1.00	1.00	1.00	1.00	1.00	1.00	1.00	1.00	1.00	1.00	1.00	1.00
Work Zone On Approach		No			No			No			No	
Adj Sat Flow, veh/h/ln	1885	1885	1885	1900	1900	1900	1885	1885	1885	1885	1885	1885
Adj Flow Rate, veh/h	62	190	11	275	108	31	24	440	318	99	757	29
Peak Hour Factor	0.91	0.91	0.91	0.91	0.91	0.91	0.91	0.91	0.91	0.91	0.91	0.91
Percent Heavy Veh, %	1	1	1	0	0	0	1	1	1	1	1	1
Cap, veh/h	339	241	14	338	296	85	285	512	370	267	1008	834
Arrive On Green	0.05	0.14	0.13	0.12	0.21	0.20	0.03	0.51	0.50	0.06	0.53	0.53
Sat Flow, veh/h	1795	1764	102	1810	1418	407	1795	1006	727	1795	1885	1561
Grp Volume(v), veh/h	62	0	201	275	0	139	24	0	758	99	757	29
Grp Sat Flow(s),veh/h/ln	1795	0	1866	1810	0	1824	1795	0	1734	1795	1885	1561
Q Serve(g_s), s	2.6	0.0	9.4	11.0	0.0	5.9	0.6	0.0	34.6	2.3	28.3	0.8
Cycle Q Clear(g_c), s	2.6	0.0	9.4	11.0	0.0	5.9	0.6	0.0	34.6	2.3	28.3	0.8
Prop In Lane	1.00		0.05	1.00		0.22	1.00		0.42	1.00		1.00
Lane Grp Cap(c), veh/h	339	0	255	338	0	381	285	0	882	267	1008	834
V/C Ratio(X)	0.18	0.00	0.79	0.81	0.00	0.36	0.08	0.00	0.86	0.37	0.75	0.03
Avail Cap(c_a), veh/h	469	0	330	338	0	381	448	0	1072	384	1166	965
HCM Platoon Ratio	1.00	1.00	1.00	1.00	1.00	1.00	1.00	1.00	1.00	1.00	1.00	1.00
Upstream Filter(I)	1.00	0.00	1.00	1.00	0.00	1.00	1.00	0.00	1.00	1.00	1.00	1.00
Uniform Delay (d), s/veh	31.1	0.0	37.8	29.2	0.0	30.7	13.8	0.0	19.6	17.0	16.4	10.0
Incr Delay (d2), s/veh	0.1	0.0	6.9	13.2	0.0	0.2	0.0	0.0	7.1	0.3	2.9	0.0
Initial Q Delay(d3),s/veh	0.0	0.0	0.0	0.0	0.0	0.0	0.0	0.0	0.0	0.0	0.0	0.0
%ile BackOfQ(50%),veh/ln	1.1	0.0	4.7	6.2	0.0	2.6	0.2	0.0	14.6	0.9	12.0	0.3
Unsig. Movement Delay, s/veh												
LnGrp Delay(d),s/veh	31.2	0.0	44.7	42.4	0.0	30.9	13.9	0.0	26.7	17.3	19.3	10.0
LnGrp LOS	C	A	D	D	A	C	B	A	C	B	B	B
Approach Vol, veh/h		263			414			782			885	
Approach Delay, s/veh		41.5			38.5			26.3			18.8	
Approach LOS		D			D			C			B	
Timer - Assigned Phs	1	2	3	4	5	6	7	8				
Phs Duration (G+Y+Rc), s	9.1	50.1	15.0	16.4	6.8	52.4	8.4	22.9				
Change Period (Y+Rc), s	4.5	5.0	4.5	4.5	4.5	5.0	4.5	4.5				
Max Green Setting (Gmax), s	10.5	55.0	10.5	15.5	10.5	55.0	10.5	15.5				
Max Q Clear Time (g_c+I1), s	4.3	36.6	13.0	11.4	2.6	30.3	4.6	7.9				
Green Ext Time (p_c), s	0.1	8.5	0.0	0.2	0.0	9.8	0.0	0.2				

Intersection Summary

HCM 6th Ctrl Delay	27.3
HCM 6th LOS	C

Notes

User approved pedestrian interval to be less than phase max green.

HCM 6th Signalized Intersection Summary

2: SW Boones Ferry Rd & SW Avery St

06/30/2021



Movement	EBL	EBT	EBR	WBL	WBT	WBR	NBL	NBT	NBR	SBL	SBT	SBR
Lane Configurations												
Traffic Volume (veh/h)	257	131	299	53	45	9	132	473	44	14	830	106
Future Volume (veh/h)	257	131	299	53	45	9	132	473	44	14	830	106
Initial Q (Qb), veh	0	0	0	0	0	0	0	0	0	0	0	0
Ped-Bike Adj(A_pbT)	0.99		0.97	1.00		0.99	1.00		0.98	1.00		0.98
Parking Bus, Adj	1.00	1.00	1.00	1.00	1.00	1.00	1.00	1.00	1.00	1.00	1.00	1.00
Work Zone On Approach		No		No		No		No		No		No
Adj Sat Flow, veh/h/ln	1841	1841	1841	1870	1870	1870	1811	1811	1811	1870	1870	1870
Adj Flow Rate, veh/h	268	136	238	55	47	4	138	493	41	15	865	100
Peak Hour Factor	0.96	0.96	0.96	0.96	0.96	0.96	0.96	0.96	0.96	0.96	0.96	0.96
Percent Heavy Veh, %	4	4	4	2	2	2	6	6	6	2	2	2
Cap, veh/h	424	130	228	128	185	16	173	967	80	437	908	105
Arrive On Green	0.15	0.22	0.21	0.04	0.11	0.10	0.05	0.59	0.57	0.02	0.55	0.55
Sat Flow, veh/h	1753	587	1028	1781	1697	144	1725	1646	137	1781	1641	190
Grp Volume(v), veh/h	268	0	374	55	0	51	138	0	534	15	0	965
Grp Sat Flow(s),veh/h/ln	1753	0	1616	1781	0	1842	1725	0	1783	1781	0	1831
Q Serve(g_s), s	15.5	0.0	26.0	3.2	0.0	3.0	4.0	0.0	20.7	0.4	0.0	58.3
Cycle Q Clear(g_c), s	15.5	0.0	26.0	3.2	0.0	3.0	4.0	0.0	20.7	0.4	0.0	58.3
Prop In Lane	1.00		0.64	1.00		0.08	1.00		0.08	1.00		0.10
Lane Grp Cap(c), veh/h	424	0	359	128	0	201	173	0	1048	437	0	1013
V/C Ratio(X)	0.63	0.00	1.04	0.43	0.00	0.25	0.80	0.00	0.51	0.03	0.00	0.95
Avail Cap(c_a), veh/h	475	0	359	153	0	201	174	0	1048	499	0	1032
HCM Platoon Ratio	1.00	1.00	1.00	1.00	1.00	1.00	1.00	1.00	1.00	1.00	1.00	1.00
Upstream Filter(I)	1.00	0.00	1.00	1.00	0.00	1.00	1.00	0.00	1.00	1.00	0.00	1.00
Uniform Delay (d), s/veh	37.2	0.0	45.9	45.5	0.0	47.8	27.5	0.0	14.2	12.8	0.0	24.7
Incr Delay (d2), s/veh	1.4	0.0	59.0	0.9	0.0	0.2	20.6	0.0	0.6	0.0	0.0	17.7
Initial Q Delay(d3),s/veh	0.0	0.0	0.0	0.0	0.0	0.0	0.0	0.0	0.0	0.0	0.0	0.0
%ile BackOfQ(50%),veh/ln	6.8	0.0	16.3	1.5	0.0	1.4	3.1	0.0	8.2	0.2	0.0	28.7
Unsig. Movement Delay, s/veh												
LnGrp Delay(d),s/veh	38.6	0.0	104.9	46.4	0.0	48.1	48.2	0.0	14.8	12.8	0.0	42.4
LnGrp LOS	D	A	F	D	A	D	D	A	B	B	A	D
Approach Vol, veh/h		642			106			672			980	
Approach Delay, s/veh		77.2			47.2			21.7			41.9	
Approach LOS		E			D			C			D	
Timer - Assigned Phs	1	2	3	4	5	6	7	8				
Phs Duration (G+Y+Rc), s	5.9	72.8	8.3	30.0	9.9	68.8	21.6	16.8				
Change Period (Y+Rc), s	4.0	5.5	4.0	5.0	4.0	5.5	4.0	5.0				
Max Green Setting (Gmax), s	6.0	64.5	6.0	25.0	6.0	64.5	21.0	10.0				
Max Q Clear Time (g_c+1/2), s	12.4	22.7	5.2	28.0	6.0	60.3	17.5	5.0				
Green Ext Time (p_c), s	0.0	6.0	0.0	0.0	0.0	3.1	0.1	0.0				

Intersection Summary

HCM 6th Ctrl Delay	45.9
HCM 6th LOS	D

Notes

User approved pedestrian interval to be less than phase max green.

HCM 6th Signalized Intersection Summary

3: SW Boones Ferry Road & SW Ibach Street/SW Ibach Court

06/30/2021



Movement	EBL	EBT	EBR	WBL	WBT	WBR	NBL	NBT	NBR	SBL	SBT	SBR
Lane Configurations												
Traffic Volume (veh/h)	165	0	176	3	1	6	208	481	2	12	884	290
Future Volume (veh/h)	165	0	176	3	1	6	208	481	2	12	884	290
Initial Q (Qb), veh	0	0	0	0	0	0	0	0	0	0	0	0
Ped-Bike Adj(A_pbT)	0.95		0.98	0.98		0.95	1.00		0.99	1.00		0.99
Parking Bus, Adj	1.00	1.00	1.00	1.00	1.00	1.00	1.00	1.00	1.00	1.00	1.00	1.00
Work Zone On Approach		No			No			No			No	
Adj Sat Flow, veh/h/ln	1885	1885	1885	1900	1900	1900	1841	1841	1841	1870	1870	1870
Adj Flow Rate, veh/h	172	0	79	3	1	6	217	501	2	12	921	245
Peak Hour Factor	0.96	0.96	0.96	0.96	0.96	0.96	0.96	0.96	0.96	0.96	0.96	0.96
Percent Heavy Veh, %	1	1	1	0	0	0	4	4	4	2	2	2
Cap, veh/h	301	0	252	103	49	149	219	1234	5	21	1048	881
Arrive On Green	0.16	0.00	0.16	0.16	0.16	0.16	0.13	0.67	0.67	0.01	0.56	0.56
Sat Flow, veh/h	1347	0	1558	310	304	921	1753	1832	7	1781	1870	1574
Grp Volume(v), veh/h	172	0	79	10	0	0	217	0	503	12	921	245
Grp Sat Flow(s),veh/h/ln	1347	0	1558	1536	0	0	1753	0	1839	1781	1870	1574
Q Serve(g_s), s	10.2	0.0	3.9	0.0	0.0	0.0	10.9	0.0	10.8	0.6	37.5	7.1
Cycle Q Clear(g_c), s	10.7	0.0	3.9	0.4	0.0	0.0	10.9	0.0	10.8	0.6	37.5	7.1
Prop In Lane	1.00		1.00	0.30		0.60	1.00		0.00	1.00		1.00
Lane Grp Cap(c), veh/h	301	0	252	301	0	0	219	0	1239	21	1048	881
V/C Ratio(X)	0.57	0.00	0.31	0.03	0.00	0.00	0.99	0.00	0.41	0.58	0.88	0.28
Avail Cap(c_a), veh/h	474	0	452	433	0	0	219	0	1239	223	1169	984
HCM Platoon Ratio	1.00	1.00	1.00	1.00	1.00	1.00	1.00	1.00	1.00	1.00	1.00	1.00
Upstream Filter(I)	1.00	0.00	1.00	1.00	0.00	0.00	1.00	0.00	1.00	1.00	1.00	1.00
Uniform Delay (d), s/veh	35.3	0.0	32.6	31.1	0.0	0.0	38.4	0.0	6.5	43.3	16.8	10.1
Incr Delay (d2), s/veh	1.0	0.0	0.4	0.0	0.0	0.0	57.8	0.0	0.3	14.9	7.9	0.3
Initial Q Delay(d3),s/veh	0.0	0.0	0.0	0.0	0.0	0.0	0.0	0.0	0.0	0.0	0.0	0.0
%ile BackOfQ(50%),veh/ln	3.6	0.0	1.5	0.2	0.0	0.0	8.0	0.0	3.5	0.3	16.2	2.3
Unsig. Movement Delay, s/veh												
LnGrp Delay(d),s/veh	36.4	0.0	33.0	31.2	0.0	0.0	96.2	0.0	6.8	58.2	24.7	10.4
LnGrp LOS	D	A	C	C	A	A	F	A	A	E	C	B
Approach Vol, veh/h		251			10			720			1178	
Approach Delay, s/veh		35.3			31.2			33.7			22.0	
Approach LOS		D			C			C			C	
Timer - Assigned Phs	1	2		4	5	6		8				
Phs Duration (G+Y+Rc), s	5.0	64.3		18.7	15.0	54.3		18.7				
Change Period (Y+Rc), s	4.0	5.0		4.5	4.0	5.0		4.5				
Max Green Setting (Gmax), s	1.0	55.0		25.5	11.0	55.0		22.0				
Max Q Clear Time (g_c+1/2g), s	12.6	12.8		12.7	12.9	39.5		2.4				
Green Ext Time (p_c), s	0.0	5.8		0.5	0.0	9.7		0.0				
Intersection Summary												
HCM 6th Ctrl Delay											27.5	
HCM 6th LOS											C	

HCM 6th TWSC
4: SW Boones Ferry Road & SW Iowa Drive

06/30/2021

Intersection												
Int Delay, s/veh	8.2											
Movement	EBL	EBT	EBR	WBL	WBT	WBR	NBL	NBT	NBR	SBL	SBT	SBR
Lane Configurations		↕			↕		↕	↕		↕	↕	
Traffic Vol, veh/h	37	0	35	13	1	39	34	591	30	36	895	51
Future Vol, veh/h	37	0	35	13	1	39	34	591	30	36	895	51
Conflicting Peds, #/hr	0	0	4	4	0	0	4	0	4	0	0	0
Sign Control	Stop	Stop	Stop	Stop	Stop	Stop	Free	Free	Free	Free	Free	Free
RT Channelized	-	-	None	-	-	None	-	-	None	-	-	None
Storage Length	-	-	-	-	-	-	95	-	-	105	-	-
Veh in Median Storage, #	-	0	-	-	0	-	-	0	-	-	0	-
Grade, %	-	0	-	-	0	-	-	0	-	-	0	-
Peak Hour Factor	94	94	94	94	94	94	94	94	94	94	94	94
Heavy Vehicles, %	5	5	5	2	2	2	3	3	3	1	1	1
Mvmt Flow	39	0	37	14	1	41	36	629	32	38	952	54

Major/Minor	Minor2		Minor1		Major1			Major2				
Conflicting Flow All	1797	1796	987	1799	1807	649	1010	0	0	665	0	0
Stage 1	1059	1059	-	721	721	-	-	-	-	-	-	-
Stage 2	738	737	-	1078	1086	-	-	-	-	-	-	-
Critical Hdwy	7.15	6.55	6.25	7.12	6.52	6.22	4.13	-	-	4.11	-	-
Critical Hdwy Stg 1	6.15	5.55	-	6.12	5.52	-	-	-	-	-	-	-
Critical Hdwy Stg 2	6.15	5.55	-	6.12	5.52	-	-	-	-	-	-	-
Follow-up Hdwy	3.545	4.045	3.345	3.518	4.018	3.318	2.227	-	-	2.209	-	-
Pot Cap-1 Maneuver	61	79	296	62	79	470	682	-	-	929	-	-
Stage 1	268	297	-	419	432	-	-	-	-	-	-	-
Stage 2	405	420	-	265	292	-	-	-	-	-	-	-
Platoon blocked, %								-	-	-	-	-
Mov Cap-1 Maneuver	51	71	294	50	71	468	679	-	-	925	-	-
Mov Cap-2 Maneuver	51	71	-	50	71	-	-	-	-	-	-	-
Stage 1	253	284	-	395	407	-	-	-	-	-	-	-
Stage 2	349	396	-	221	279	-	-	-	-	-	-	-

Approach	EB		WB		NB		SB	
HCM Control Delay, s	158		43.6		0.6		0.3	
HCM LOS	F		E					

Minor Lane/Major Mvmt	NBL	NBT	NBR	EBLn1WBLn1	SBL	SBT	SBR
Capacity (veh/h)	679	-	-	85	148	925	-
HCM Lane V/C Ratio	0.053	-	-	0.901	0.381	0.041	-
HCM Control Delay (s)	10.6	-	-	158	43.6	9.1	-
HCM Lane LOS	B	-	-	F	E	A	-
HCM 95th %tile Q(veh)	0.2	-	-	4.9	1.6	0.1	-

HCM 6th TWSC
5: SW Boones Ferry Road & SW Norwood Road

06/30/2021

Intersection						
Int Delay, s/veh	3.1					
Movement	WBL	WBR	NBT	NBR	SBL	SBT
Lane Configurations	Y		↑	↑	↑	↑
Traffic Vol, veh/h	52	106	549	115	139	804
Future Vol, veh/h	52	106	549	115	139	804
Conflicting Peds, #/hr	2	2	0	2	2	0
Sign Control	Stop	Stop	Free	Free	Free	Free
RT Channelized	-	None	-	None	-	None
Storage Length	-	-	-	65	290	-
Veh in Median Storage, #	0	-	0	-	-	0
Grade, %	0	-	0	-	-	0
Peak Hour Factor	95	95	95	95	95	95
Heavy Vehicles, %	2	2	3	3	2	2
Mvmt Flow	55	112	578	121	146	846

Major/Minor	Minor1	Major1	Major2		
Conflicting Flow All	1720	582	0	0	701
Stage 1	580	-	-	-	-
Stage 2	1140	-	-	-	-
Critical Hdwy	6.42	6.22	-	-	4.12
Critical Hdwy Stg 1	5.42	-	-	-	-
Critical Hdwy Stg 2	5.42	-	-	-	-
Follow-up Hdwy	3.518	3.318	-	-	2.218
Pot Cap-1 Maneuver	98	513	-	-	896
Stage 1	560	-	-	-	-
Stage 2	305	-	-	-	-
Platoon blocked, %			-	-	-
Mov Cap-1 Maneuver	82	511	-	-	894
Mov Cap-2 Maneuver	191	-	-	-	-
Stage 1	559	-	-	-	-
Stage 2	255	-	-	-	-

Approach	WB	NB	SB
HCM Control Delay, s	26.6	0	1.4
HCM LOS	D		

Minor Lane/Major Mvmt	NBT	NBRWBLn1	SBL	SBT
Capacity (veh/h)	-	-	329	894
HCM Lane V/C Ratio	-	-	0.506	0.164
HCM Control Delay (s)	-	-	26.6	9.8
HCM Lane LOS	-	-	D	A
HCM 95th %tile Q(veh)	-	-	2.7	0.6

HCM 6th TWSC
6: SW Boones Ferry Road & Site Access

09/20/2021

Intersection						
Int Delay, s/veh	1.4					
Movement	WBL	WBR	NBT	NBR	SBL	SBT
Lane Configurations	↘	↗	↑	↗	↘	↑
Traffic Vol, veh/h	62	38	621	104	57	809
Future Vol, veh/h	62	38	621	104	57	809
Conflicting Peds, #/hr	2	2	0	2	2	0
Sign Control	Stop	Stop	Free	Free	Free	Free
RT Channelized	-	None	-	None	-	None
Storage Length	-	150	-	150	150	-
Veh in Median Storage, #	2	-	0	-	-	0
Grade, %	0	-	0	-	-	0
Peak Hour Factor	95	95	95	95	95	95
Heavy Vehicles, %	0	0	3	3	2	2
Mvmt Flow	65	40	654	109	60	852

Major/Minor	Minor1	Major1	Major2		
Conflicting Flow All	1630	658	0	0	765
Stage 1	656	-	-	-	-
Stage 2	974	-	-	-	-
Critical Hdwy	6.4	6.2	-	-	4.12
Critical Hdwy Stg 1	5.4	-	-	-	-
Critical Hdwy Stg 2	5.4	-	-	-	-
Follow-up Hdwy	3.5	3.3	-	-	2.218
Pot Cap-1 Maneuver	113	468	-	-	848
Stage 1	520	-	-	-	-
Stage 2	369	-	-	-	-
Platoon blocked, %			-	-	-
Mov Cap-1 Maneuver	105	466	-	-	846
Mov Cap-2 Maneuver	286	-	-	-	-
Stage 1	519	-	-	-	-
Stage 2	342	-	-	-	-

Approach	WB	NB	SB
HCM Control Delay, s	18.3	0	0.6
HCM LOS	C		

Minor Lane/Major Mvmt	NBT	NBRWBLn1	WBLn2	SBL	SBT
Capacity (veh/h)	-	-	286	466	846
HCM Lane V/C Ratio	-	-	0.228	0.086	0.071
HCM Control Delay (s)	-	-	21.3	13.4	9.6
HCM Lane LOS	-	-	C	B	A
HCM 95th %tile Q(veh)	-	-	0.9	0.3	0.2

Intersection						
Int Delay, s/veh	0					
Movement	WBL	WBR	NBT	NBR	SBL	SBT
Lane Configurations	↔		↔		↔	↔
Traffic Vol, veh/h	0	0	724	2	1	869
Future Vol, veh/h	0	0	724	2	1	869
Conflicting Peds, #/hr	2	2	0	2	2	0
Sign Control	Stop	Stop	Free	Free	Free	Free
RT Channelized	-	None	-	None	-	None
Storage Length	-	-	-	-	150	-
Veh in Median Storage, #	2	-	0	-	-	0
Grade, %	0	-	0	-	-	0
Peak Hour Factor	95	95	95	95	95	95
Heavy Vehicles, %	0	0	3	3	2	2
Mvmt Flow	0	0	762	2	1	915

Major/Minor	Minor1	Major1	Major2		
Conflicting Flow All	1684	767	0	0	766
Stage 1	765	-	-	-	-
Stage 2	919	-	-	-	-
Critical Hdwy	6.4	6.2	-	-	4.12
Critical Hdwy Stg 1	5.4	-	-	-	-
Critical Hdwy Stg 2	5.4	-	-	-	-
Follow-up Hdwy	3.5	3.3	-	-	2.218
Pot Cap-1 Maneuver	105	405	-	-	847
Stage 1	463	-	-	-	-
Stage 2	392	-	-	-	-
Platoon blocked, %			-	-	-
Mov Cap-1 Maneuver	104	403	-	-	845
Mov Cap-2 Maneuver	299	-	-	-	-
Stage 1	462	-	-	-	-
Stage 2	391	-	-	-	-

Approach	WB	NB	SB
HCM Control Delay, s	0	0	0
HCM LOS	A		

Minor Lane/Major Mvmt	NBT	NBRWBLn1	SBL	SBT
Capacity (veh/h)	-	-	-	845
HCM Lane V/C Ratio	-	-	-	0.001
HCM Control Delay (s)	-	-	0	9.3
HCM Lane LOS	-	-	A	A
HCM 95th %tile Q(veh)	-	-	-	0

HCM 6th Signalized Intersection Summary
 8: SW Boones Ferry Road & SW Day Road

06/30/2021



Movement	EBL	EBT	EBR	WBL	WBT	WBR	NBL	NBT	NBR	SBL	SBT	SBR
Lane Configurations		↔	↔		↔		↔	↔		↔	↔	↔
Traffic Volume (veh/h)	29	0	811	0	0	0	664	695	0	0	783	85
Future Volume (veh/h)	29	0	811	0	0	0	664	695	0	0	783	85
Initial Q (Qb), veh	0	0	0	0	0	0	0	0	0	0	0	0
Ped-Bike Adj(A_pbT)	1.00		1.00	1.00		1.00	1.00		1.00	1.00		1.00
Parking Bus, Adj	1.00	1.00	1.00	1.00	1.00	1.00	1.00	1.00	1.00	1.00	1.00	1.00
Work Zone On Approach		No			No			No			No	
Adj Sat Flow, veh/h/ln	1870	1870	1870	1900	1900	1900	1856	1856	1856	1885	1885	1885
Adj Flow Rate, veh/h	30	0	777	0	0	0	678	709	0	0	799	82
Peak Hour Factor	0.98	0.98	0.98	0.98	0.98	0.98	0.98	0.98	0.98	0.98	0.98	0.98
Percent Heavy Veh, %	2	2	2	0	0	0	3	3	3	1	1	1
Cap, veh/h	271	0	659	0	271	0	748	783	0	543	1569	161
Arrive On Green	0.14	0.00	0.15	0.00	0.00	0.00	0.53	0.84	0.00	0.00	0.48	0.47
Sat Flow, veh/h	1418	0	1585	0	1900	0	2827	1856	0	1795	3279	336
Grp Volume(v), veh/h	30	0	777	0	0	0	678	709	0	0	436	445
Grp Sat Flow(s),veh/h/ln	1418	0	1585	0	1900	0	1414	1856	0	1795	1791	1825
Q Serve(g_s), s	2.0	0.0	15.9	0.0	0.0	0.0	22.8	26.5	0.0	0.0	17.6	17.7
Cycle Q Clear(g_c), s	2.0	0.0	15.9	0.0	0.0	0.0	22.8	26.5	0.0	0.0	17.6	17.7
Prop In Lane	1.00		1.00	0.00		0.00	1.00		0.00	1.00		0.18
Lane Grp Cap(c), veh/h	264	0	659	0	271	0	748	783	0	543	857	873
V/C Ratio(X)	0.11	0.00	1.18	0.00	0.00	0.00	0.91	0.91	0.00	0.00	0.51	0.51
Avail Cap(c_a), veh/h	264	0	659	0	271	0	1158	1219	0	543	857	873
HCM Platoon Ratio	1.00	1.00	1.00	1.00	1.00	1.00	2.00	2.00	2.00	1.00	1.00	1.00
Upstream Filter(I)	1.00	0.00	1.00	0.00	0.00	0.00	0.89	0.89	0.00	0.00	1.00	1.00
Uniform Delay (d), s/veh	39.6	0.0	30.7	0.0	0.0	0.0	23.6	6.8	0.0	0.0	18.9	19.0
Incr Delay (d2), s/veh	0.1	0.0	95.6	0.0	0.0	0.0	5.2	14.6	0.0	0.0	2.2	2.1
Initial Q Delay(d3),s/veh	0.0	0.0	0.0	0.0	0.0	0.0	0.0	0.0	0.0	0.0	0.0	0.0
%ile BackOfQ(50%),veh/ln	0.7	0.0	33.0	0.0	0.0	0.0	5.4	6.1	0.0	0.0	7.2	7.4
Unsig. Movement Delay, s/veh												
LnGrp Delay(d),s/veh	39.8	0.0	126.2	0.0	0.0	0.0	28.8	21.4	0.0	0.0	21.0	21.1
LnGrp LOS	D	A	F	A	A	A	C	C	A	A	C	C
Approach Vol, veh/h		807			0			1387			881	
Approach Delay, s/veh		123.0			0.0			25.0			21.1	
Approach LOS		F						C			C	
Timer - Assigned Phs	1	2		4	5	6		8				
Phs Duration (G+Y+Rc), s	31.8	54.2		19.0	40.0	46.0		19.0				
Change Period (Y+Rc), s	* 5.4	* 5.4		4.5	* 5.4	* 5.4		4.5				
Max Green Setting (Gmax), s	* 42	* 34		14.5	* 8.5	* 68		14.5				
Max Q Clear Time (g_c+I1), s	24.8	19.7		0.0	0.0	28.5		17.9				
Green Ext Time (p_c), s	1.6	6.5		0.0	0.0	9.7		0.0				

Intersection Summary

HCM 6th Ctrl Delay	49.6
HCM 6th LOS	D

Notes

- User approved pedestrian interval to be less than phase max green.
- * HCM 6th computational engine requires equal clearance times for the phases crossing the barrier.

HCM 6th Signalized Intersection Summary

9: SW Boones Ferry Road & SW 95th Avenue

06/30/2021



Movement	EBL	EBT	EBR	WBL	WBT	WBR	NBL	NBT	NBR	SBL	SBT	SBR
Lane Configurations		↕	↗	↖	↘	↙	↗	↖		↖	↗	↘
Traffic Volume (veh/h)	241	1	834	50	18	7	605	1015	12	3	1237	245
Future Volume (veh/h)	241	1	834	50	18	7	605	1015	12	3	1237	245
Initial Q (Qb), veh	0	0	0	0	0	0	0	0	0	0	0	0
Ped-Bike Adj(A_pbT)	0.99		0.97	1.00		0.99	1.00		1.00	1.00		1.00
Parking Bus, Adj	1.00	1.00	1.00	1.00	1.00	1.00	1.00	1.00	1.00	1.00	1.00	1.00
Work Zone On Approach		No		No		No		No		No		No
Adj Sat Flow, veh/h/ln	1826	1826	1826	1870	1870	1870	1781	1781	1781	1856	1856	1856
Adj Flow Rate, veh/h	251	1	869	52	19	7	630	1057	12	3	1289	0
Peak Hour Factor	0.96	0.96	0.96	0.96	0.96	0.96	0.96	0.96	0.96	0.96	0.96	0.96
Percent Heavy Veh, %	5	5	5	2	2	2	8	8	8	3	3	3
Cap, veh/h	281	1	1053	75	223	82	727	1318	15	583	1740	
Arrive On Green	0.16	0.17	0.17	0.17	0.17	0.17	0.44	0.77	0.75	0.66	0.99	0.00
Sat Flow, veh/h	1239	5	2634	636	1302	480	3291	3428	39	1767	3526	1572
Grp Volume(v), veh/h	252	0	869	52	0	26	630	522	547	3	1289	0
Grp Sat Flow(s),veh/h/ln	1244	0	1317	636	0	1781	1646	1692	1774	1767	1763	1572
Q Serve(g_s), s	15.7	0.0	18.0	1.0	0.0	1.3	18.2	19.5	19.5	0.1	1.9	0.0
Cycle Q Clear(g_c), s	17.0	0.0	18.0	18.0	0.0	1.3	18.2	19.5	19.5	0.1	1.9	0.0
Prop In Lane	1.00		1.00	1.00		0.27	1.00		0.02	1.00		1.00
Lane Grp Cap(c), veh/h	270	0	1053	75	0	305	727	651	682	583	1740	
V/C Ratio(X)	0.93	0.00	0.83	0.70	0.00	0.09	0.87	0.80	0.80	0.01	0.74	
Avail Cap(c_a), veh/h	270	0	1053	75	0	305	1066	1048	1098	583	1740	
HCM Platoon Ratio	1.00	1.00	1.00	1.00	1.00	1.00	2.00	2.00	2.00	2.00	2.00	2.00
Upstream Filter(I)	1.00	0.00	1.00	1.00	0.00	1.00	0.55	0.55	0.55	0.52	0.52	0.00
Uniform Delay (d), s/veh	45.8	0.0	28.9	52.4	0.0	36.6	27.9	9.7	9.7	12.0	0.4	0.0
Incr Delay (d2), s/veh	37.2	0.0	5.3	23.2	0.0	0.1	3.0	5.8	5.5	0.0	1.5	0.0
Initial Q Delay(d3),s/veh	0.0	0.0	0.0	0.0	0.0	0.0	0.0	0.0	0.0	0.0	0.0	0.0
%ile BackOfQ(50%),veh/ln	0.5	0.0	10.3	1.8	0.0	0.6	5.4	4.3	4.5	0.0	0.6	0.0
Unsig. Movement Delay, s/veh												
LnGrp Delay(d),s/veh	83.0	0.0	34.2	75.7	0.0	36.7	30.9	15.5	15.2	12.0	1.9	0.0
LnGrp LOS	F	A	C	E	A	D	C	B	B	B	A	
Approach Vol, veh/h		1121			78			1699			1292	A
Approach Delay, s/veh		45.2			62.7			21.1			1.9	
Approach LOS		D			E			C			A	
Timer - Assigned Phs	1	2		4	5	6		8				
Phs Duration (G+Y+Rc), s	37.2	55.8		22.0	38.6	44.4		22.0				
Change Period (Y+Rc), s	5.0	5.0		5.0	5.0	5.0		5.0				
Max Green Setting (Gmax), s	33.0	40.0		17.0	9.0	64.0		17.0				
Max Q Clear Time (g_c+Q), s	20.2	3.9		20.0	2.1	21.5		20.0				
Green Ext Time (p_c), s	2.0	12.2		0.0	0.0	17.9		0.0				

Intersection Summary

HCM 6th Ctrl Delay	22.4
HCM 6th LOS	C

Notes

- User approved pedestrian interval to be less than phase max green.
- Unsignalized Delay for [SBR] is excluded from calculations of the approach delay and intersection delay.

HCM Signalized Intersection Capacity Analysis
 10: I-5 SB Ramps & SW Boones Ferry Road/SW Elligsen Road

06/27/2021



Movement	EBL	EBT	EBR	WBL	WBT	WBR	NBL	NBT	NBR	SBL	SBT	SBR
Lane Configurations		↑↑	↗		↑↑	↗				↘	↖	↗
Traffic Volume (vph)	0	1167	953	0	759	389	0	0	0	597	91	872
Future Volume (vph)	0	1167	953	0	759	389	0	0	0	597	91	872
Ideal Flow (vphpl)	1900	1900	1900	1900	1900	1900	1900	1900	1900	1900	1900	1900
Lane Width	12	12	12	12	12	12	12	12	12	12	12	16
Total Lost time (s)		4.0	4.0		4.0	3.0				4.0	4.0	4.0
Lane Util. Factor		0.95	1.00		0.95	1.00				0.95	0.95	1.00
Fr _t		1.00	0.85		1.00	0.85				1.00	1.00	0.85
Fl _t Protected		1.00	1.00		1.00	1.00				0.95	0.96	1.00
Satd. Flow (prot)		3505	1568		3505	1568				1603	1627	1711
Fl _t Permitted		1.00	1.00		1.00	1.00				0.95	0.96	1.00
Satd. Flow (perm)		3505	1568		3505	1568				1603	1627	1711
Peak-hour factor, PHF	0.97	0.97	0.97	0.97	0.97	0.97	0.97	0.97	0.97	0.97	0.97	0.97
Adj. Flow (vph)	0	1203	982	0	782	401	0	0	0	615	94	899
RTOR Reduction (vph)	0	0	0	0	0	0	0	0	0	0	0	42
Lane Group Flow (vph)	0	1203	982	0	782	401	0	0	0	351	358	857
Heavy Vehicles (%)	3%	3%	3%	3%	3%	3%	0%	0%	0%	7%	7%	7%
Turn Type		NA	Free		NA	Free				Split	NA	custom
Protected Phases		2			6					4	4	5
Permitted Phases			Free		6	Free						4
Actuated Green, G (s)		67.8	105.0		38.3	105.0				27.7	27.7	52.7
Effective Green, g (s)		68.8	105.0		39.3	105.0				28.2	28.2	53.7
Actuated g/C Ratio		0.66	1.00		0.37	1.00				0.27	0.27	0.51
Clearance Time (s)		5.0			5.0					4.5	4.5	4.5
Vehicle Extension (s)		4.1			4.1					2.3	2.3	2.3
Lane Grp Cap (vph)		2296	1568		1311	1568				430	436	940
v/s Ratio Prot		0.34			0.22					0.22	0.22	c0.22
v/s Ratio Perm			c0.63			0.26						0.28
v/c Ratio		0.52	0.63		0.60	0.26				0.82	0.82	0.91
Uniform Delay, d ₁		9.5	0.0		26.5	0.0				36.0	36.0	23.5
Progression Factor		0.85	1.00		1.09	1.00				1.00	1.00	1.00
Incremental Delay, d ₂		0.5	1.2		1.9	0.4				11.0	11.4	12.7
Delay (s)		8.7	1.2		30.7	0.4				47.0	47.5	36.2
Level of Service		A	A		C	A				D	D	D
Approach Delay (s)		5.3			20.4			0.0			41.1	
Approach LOS		A			C			A			D	
Intersection Summary												
HCM 2000 Control Delay			20.5									HCM 2000 Level of Service C
HCM 2000 Volume to Capacity ratio			0.86									
Actuated Cycle Length (s)			105.0								12.0	Sum of lost time (s)
Intersection Capacity Utilization			81.6%									ICU Level of Service D
Analysis Period (min)			15									

c Critical Lane Group

V/C Ratio calculated using HCM worksheet with correct critical movements and lost time

HCM 6th Signalized Intersection Summary
 11: I-5 NB Ramps & SW Elligsen Road

06/30/2021

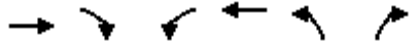

Movement	EBT	EBR	WBL	WBT	NBL	NBR
Lane Configurations	↑↑	↗		↑↑	↘↘	↗
Traffic Volume (veh/h)	1026	741	0	798	352	245
Future Volume (veh/h)	1026	741	0	798	352	245
Initial Q (Qb), veh	0	0	0	0	0	0
Ped-Bike Adj(A_pbT)		1.00	1.00		1.00	1.00
Parking Bus, Adj	1.00	1.00	1.00	1.00	1.00	1.00
Work Zone On Approach	No			No	No	
Adj Sat Flow, veh/h/ln	1841	1841	0	1885	1841	1841
Adj Flow Rate, veh/h	1127	0	0	877	387	0
Peak Hour Factor	0.91	0.91	0.91	0.91	0.91	0.91
Percent Heavy Veh, %	4	4	0	1	4	4
Cap, veh/h	2733		0	2799	484	
Arrive On Green	1.00	0.00	0.00	0.78	0.14	0.00
Sat Flow, veh/h	3589	1560	0	3770	3401	1560
Grp Volume(v), veh/h	1127	0	0	877	387	0
Grp Sat Flow(s),veh/h/ln	1749	1560	0	1791	1700	1560
Q Serve(g_s), s	0.0	0.0	0.0	7.4	11.6	0.0
Cycle Q Clear(g_c), s	0.0	0.0	0.0	7.4	11.6	0.0
Prop In Lane		1.00	0.00		1.00	1.00
Lane Grp Cap(c), veh/h	2733		0	2799	484	
V/C Ratio(X)	0.41		0.00	0.31	0.80	
Avail Cap(c_a), veh/h	2733		0	2799	1166	
HCM Platoon Ratio	2.00	2.00	1.00	1.00	1.00	1.00
Upstream Filter(I)	0.78	0.00	0.00	1.00	1.00	0.00
Uniform Delay (d), s/veh	0.0	0.0	0.0	3.3	43.6	0.0
Incr Delay (d2), s/veh	0.4	0.0	0.0	0.3	1.9	0.0
Initial Q Delay(d3),s/veh	0.0	0.0	0.0	0.0	0.0	0.0
%ile BackOfQ(50%),veh/ln	0.1	0.0	0.0	2.0	5.0	0.0
Unsig. Movement Delay, s/veh						
LnGrp Delay(d),s/veh	0.4	0.0	0.0	3.6	45.5	0.0
LnGrp LOS	A		A	A	D	
Approach Vol, veh/h	1127	A		877	387	A
Approach Delay, s/veh	0.4			3.6	45.5	
Approach LOS	A			A	D	
Timer - Assigned Phs		2			6	8
Phs Duration (G+Y+Rc), s		86.0			86.0	19.0
Change Period (Y+Rc), s		5.0			5.0	4.5
Max Green Setting (Gmax), s		60.0			60.0	35.5
Max Q Clear Time (g_c+I1), s		2.0			9.4	13.6
Green Ext Time (p_c), s		17.2			11.4	0.9

Intersection Summary

HCM 6th Ctrl Delay	8.9
HCM 6th LOS	A

Notes

Unsignalized Delay for [NBR, EBR] is excluded from calculations of the approach delay and intersection delay.

HCM 6th TWSC
 12: SW Norwood Road & SW 89th Avenue

06/30/2021

Intersection												
Int Delay, s/veh	1.4											
Movement	EBL	EBT	EBR	WBL	WBT	WBR	NBL	NBT	NBR	SBL	SBT	SBR
Lane Configurations		↕			↕			↕			↕	
Traffic Vol, veh/h	33	237	23	5	170	14	13	0	3	11	0	9
Future Vol, veh/h	33	237	23	5	170	14	13	0	3	11	0	9
Conflicting Peds, #/hr	2	0	0	0	0	2	0	0	0	2	0	2
Sign Control	Free	Free	Free	Free	Free	Free	Stop	Stop	Stop	Stop	Stop	Stop
RT Channelized	-	-	None	-	-	None	-	-	None	-	-	None
Storage Length	-	-	-	-	-	-	-	-	-	-	-	-
Veh in Median Storage, #	-	0	-	-	0	-	-	0	-	-	0	-
Grade, %	-	0	-	-	0	-	-	0	-	-	0	-
Peak Hour Factor	92	92	92	92	92	92	92	92	92	92	92	92
Heavy Vehicles, %	1	1	2	2	0	0	2	2	2	0	2	0
Mvmt Flow	36	258	25	5	185	15	14	0	3	12	0	10

Major/Minor	Major1			Major2			Minor1			Minor2		
Conflicting Flow All	202	0	0	283	0	0	553	555	273	551	560	197
Stage 1	-	-	-	-	-	-	343	343	-	205	205	-
Stage 2	-	-	-	-	-	-	210	212	-	346	355	-
Critical Hdwy	4.11	-	-	4.12	-	-	7.12	6.52	6.22	7.1	6.52	6.2
Critical Hdwy Stg 1	-	-	-	-	-	-	6.12	5.52	-	6.1	5.52	-
Critical Hdwy Stg 2	-	-	-	-	-	-	6.12	5.52	-	6.1	5.52	-
Follow-up Hdwy	2.209	-	-	2.218	-	-	3.518	4.018	3.318	3.5	4.018	3.3
Pot Cap-1 Maneuver	1376	-	-	1279	-	-	444	440	766	448	437	849
Stage 1	-	-	-	-	-	-	672	637	-	802	732	-
Stage 2	-	-	-	-	-	-	792	727	-	674	630	-
Platoon blocked, %	-	-	-	-	-	-	-	-	-	-	-	-
Mov Cap-1 Maneuver	1373	-	-	1279	-	-	426	424	765	433	421	846
Mov Cap-2 Maneuver	-	-	-	-	-	-	426	424	-	433	421	-
Stage 1	-	-	-	-	-	-	651	617	-	776	728	-
Stage 2	-	-	-	-	-	-	778	723	-	649	610	-

Approach	EB			WB			NB			SB		
HCM Control Delay, s	0.9			0.2			13			11.8		
HCM LOS							B			B		

Minor Lane/Major Mvmt	NBLn1	EBL	EBT	EBR	WBL	WBT	WBR	SBLn1
Capacity (veh/h)	465	1373	-	-	1279	-	-	555
HCM Lane V/C Ratio	0.037	0.026	-	-	0.004	-	-	0.039
HCM Control Delay (s)	13	7.7	0	-	7.8	0	-	11.8
HCM Lane LOS	B	A	A	-	A	A	-	B
HCM 95th %tile Q(veh)	0.1	0.1	-	-	0	-	-	0.1

HCM 6th TWSC
 13: SW Norwood Road & SW Vermillion Drive

06/30/2021

Intersection												
Int Delay, s/veh	3.7											
Movement	EBL	EBT	EBR	WBL	WBT	WBR	NBL	NBT	NBR	SBL	SBT	SBR
Lane Configurations		↕			↕			↕			↕	
Traffic Vol, veh/h	70	144	37	25	132	39	20	0	17	24	0	37
Future Vol, veh/h	70	144	37	25	132	39	20	0	17	24	0	37
Conflicting Peds, #/hr	0	0	0	0	0	0	0	0	0	0	0	0
Sign Control	Free	Free	Free	Free	Free	Free	Stop	Stop	Stop	Stop	Stop	Stop
RT Channelized	-	-	None	-	-	None	-	-	None	-	-	None
Storage Length	-	-	-	-	-	-	-	-	-	-	-	-
Veh in Median Storage, #	-	0	-	-	0	-	-	0	-	-	0	-
Grade, %	-	0	-	-	0	-	-	0	-	-	0	-
Peak Hour Factor	72	72	92	92	72	72	92	92	92	72	92	72
Heavy Vehicles, %	1	1	2	2	0	0	2	2	2	0	2	0
Mvmt Flow	97	200	40	27	183	54	22	0	18	33	0	51

Major/Minor	Major1			Major2			Minor1			Minor2		
Conflicting Flow All	237	0	0	240	0	0	704	705	220	687	698	210
Stage 1	-	-	-	-	-	-	414	414	-	264	264	-
Stage 2	-	-	-	-	-	-	290	291	-	423	434	-
Critical Hdwy	4.11	-	-	4.12	-	-	7.12	6.52	6.22	7.1	6.52	6.2
Critical Hdwy Stg 1	-	-	-	-	-	-	6.12	5.52	-	6.1	5.52	-
Critical Hdwy Stg 2	-	-	-	-	-	-	6.12	5.52	-	6.1	5.52	-
Follow-up Hdwy	2.209	-	-	2.218	-	-	3.518	4.018	3.318	3.5	4.018	3.3
Pot Cap-1 Maneuver	1336	-	-	1327	-	-	352	361	820	364	364	835
Stage 1	-	-	-	-	-	-	616	593	-	746	690	-
Stage 2	-	-	-	-	-	-	718	672	-	613	581	-
Platoon blocked, %	-	-	-	-	-	-	-	-	-	-	-	-
Mov Cap-1 Maneuver	1336	-	-	1327	-	-	303	323	820	327	325	835
Mov Cap-2 Maneuver	-	-	-	-	-	-	303	323	-	327	325	-
Stage 1	-	-	-	-	-	-	564	543	-	683	673	-
Stage 2	-	-	-	-	-	-	658	656	-	549	532	-

Approach	EB			WB			NB			SB		
HCM Control Delay, s	2.3			0.8			14.3			13.3		
HCM LOS							B			B		

Minor Lane/Major Mvmt	NBLn1	EBL	EBT	EBR	WBL	WBT	WBR	SBLn1
Capacity (veh/h)	427	1336	-	-	1327	-	-	518
HCM Lane V/C Ratio	0.094	0.073	-	-	0.02	-	-	0.164
HCM Control Delay (s)	14.3	7.9	0	-	7.8	0	-	13.3
HCM Lane LOS	B	A	A	-	A	A	-	B
HCM 95th %tile Q(veh)	0.3	0.2	-	-	0.1	-	-	0.6

HCM 6th TWSC
 14: SW 82nd Avenue & SW Norwood Road/Driveway

06/30/2021

Intersection												
Int Delay, s/veh	7.1											
Movement	EBL	EBT	EBR	WBL	WBT	WBR	NBL	NBT	NBR	SBL	SBT	SBR
Lane Configurations		↕			↕			↕			↕	↗
Traffic Vol, veh/h	150	0	35	0	0	1	21	8	0	2	4	175
Future Vol, veh/h	150	0	35	0	0	1	21	8	0	2	4	175
Conflicting Peds, #/hr	0	0	0	0	0	0	0	0	0	0	0	0
Sign Control	Free	Free	Free	Free	Free	Free	Stop	Stop	Stop	Stop	Stop	Stop
RT Channelized	-	-	None	-	-	None	-	-	None	-	-	Free
Storage Length	-	-	-	-	-	-	-	-	-	-	-	15
Veh in Median Storage, #	-	0	-	-	0	-	-	0	-	-	0	-
Grade, %	-	0	-	-	0	-	-	0	-	-	0	-
Peak Hour Factor	83	83	83	83	83	83	83	83	83	83	83	83
Heavy Vehicles, %	0	0	0	0	0	0	0	0	0	0	0	0
Mvmt Flow	181	0	42	0	0	1	25	10	0	2	5	211

Major/Minor	Major1			Major2			Minor1			Minor2		
Conflicting Flow All	1	0	0	42	0	0	386	384	21	389	405	-
Stage 1	-	-	-	-	-	-	383	383	-	1	1	-
Stage 2	-	-	-	-	-	-	3	1	-	388	404	-
Critical Hdwy	4.1	-	-	4.1	-	-	7.1	6.5	6.2	7.1	6.5	-
Critical Hdwy Stg 1	-	-	-	-	-	-	6.1	5.5	-	6.1	5.5	-
Critical Hdwy Stg 2	-	-	-	-	-	-	6.1	5.5	-	6.1	5.5	-
Follow-up Hdwy	2.2	-	-	2.2	-	-	3.5	4	3.3	3.5	4	-
Pot Cap-1 Maneuver	1635	-	-	1580	-	-	576	553	1062	574	538	0
Stage 1	-	-	-	-	-	-	644	616	-	1027	899	0
Stage 2	-	-	-	-	-	-	1025	899	-	640	603	0
Platoon blocked, %	-	-	-	-	-	-	-	-	-	-	-	-
Mov Cap-1 Maneuver	1635	-	-	1580	-	-	522	490	1062	516	477	-
Mov Cap-2 Maneuver	-	-	-	-	-	-	522	490	-	516	477	-
Stage 1	-	-	-	-	-	-	571	546	-	910	899	-
Stage 2	-	-	-	-	-	-	1020	899	-	557	534	-

Approach	EB			WB			NB			SB		
HCM Control Delay, s	6.1			0			12.5			12.5		
HCM LOS							B			B		

Minor Lane/Major Mvmt	NBLn1	EBL	EBT	EBR	WBL	WBT	WBR	SBLn1	SBLn2
Capacity (veh/h)	513	1635	-	-	1580	-	-	489	-
HCM Lane V/C Ratio	0.068	0.111	-	-	-	-	-	0.015	-
HCM Control Delay (s)	12.5	7.5	0	-	0	-	-	12.5	0
HCM Lane LOS	B	A	A	-	A	-	-	B	A
HCM 95th %tile Q(veh)	0.2	0.4	-	-	0	-	-	0	-

Intersection						
Int Delay, s/veh	4.4					
Movement	EBL	EBR	NBL	NBT	SBT	SBR
Lane Configurations	T			T		
Traffic Vol, veh/h	82	72	65	227	403	139
Future Vol, veh/h	82	72	65	227	403	139
Conflicting Peds, #/hr	0	0	0	0	0	0
Sign Control	Stop	Stop	Free	Free	Free	Free
RT Channelized	-	None	-	None	-	None
Storage Length	-	-	-	-	-	-
Veh in Median Storage, #	0	-	-	0	0	-
Grade, %	0	-	-	0	0	-
Peak Hour Factor	89	89	89	89	89	89
Heavy Vehicles, %	0	0	2	2	0	0
Mvmt Flow	92	81	73	255	453	156

Major/Minor	Minor2	Major1	Major2			
Conflicting Flow All	932	531	609	0	-	0
Stage 1	531	-	-	-	-	-
Stage 2	401	-	-	-	-	-
Critical Hdwy	6.4	6.2	4.12	-	-	-
Critical Hdwy Stg 1	5.4	-	-	-	-	-
Critical Hdwy Stg 2	5.4	-	-	-	-	-
Follow-up Hdwy	3.5	3.3	2.218	-	-	-
Pot Cap-1 Maneuver	298	552	970	-	-	-
Stage 1	594	-	-	-	-	-
Stage 2	681	-	-	-	-	-
Platoon blocked, %				-	-	-
Mov Cap-1 Maneuver	272	552	970	-	-	-
Mov Cap-2 Maneuver	272	-	-	-	-	-
Stage 1	542	-	-	-	-	-
Stage 2	681	-	-	-	-	-

Approach	EB	NB	SB
HCM Control Delay, s	24.2	2	0
HCM LOS	C		

Minor Lane/Major Mvmt	NBL	NBT	EBLn1	SBT	SBR
Capacity (veh/h)	970	-	357	-	-
HCM Lane V/C Ratio	0.075	-	0.485	-	-
HCM Control Delay (s)	9	0	24.2	-	-
HCM Lane LOS	A	A	C	-	-
HCM 95th %tile Q(veh)	0.2	-	2.5	-	-

HCM 6th Signalized Intersection Summary
 1: SW Boones Ferry Rd & SW Sagert St

06/30/2021



Movement	EBL	EBT	EBR	WBL	WBT	WBR	NBL	NBT	NBR	SBL	SBT	SBR
Lane Configurations												
Traffic Volume (veh/h)	73	80	12	191	102	63	8	634	312	53	287	48
Future Volume (veh/h)	73	80	12	191	102	63	8	634	312	53	287	48
Initial Q (Qb), veh	0	0	0	0	0	0	0	0	0	0	0	0
Ped-Bike Adj(A_pbT)	1.00		0.99	1.00		1.00	1.00		0.98	1.00		0.98
Parking Bus, Adj	1.00	1.00	1.00	1.00	1.00	1.00	1.00	1.00	1.00	1.00	1.00	1.00
Work Zone On Approach		No			No			No			No	
Adj Sat Flow, veh/h/ln	1885	1885	1885	1900	1900	1900	1885	1885	1885	1811	1811	1811
Adj Flow Rate, veh/h	80	88	8	210	112	47	9	697	327	58	315	31
Peak Hour Factor	0.91	0.91	0.91	0.91	0.91	0.91	0.91	0.91	0.91	0.91	0.91	0.91
Percent Heavy Veh, %	1	1	1	0	0	0	1	1	1	6	6	6
Cap, veh/h	248	137	12	325	174	73	661	709	333	166	1121	929
Arrive On Green	0.06	0.08	0.08	0.12	0.14	0.13	0.02	0.59	0.58	0.05	0.62	0.62
Sat Flow, veh/h	1795	1701	155	1810	1269	533	1795	1204	565	1725	1811	1501
Grp Volume(v), veh/h	80	0	96	210	0	159	9	0	1024	58	315	31
Grp Sat Flow(s),veh/h/ln	1795	0	1856	1810	0	1802	1795	0	1768	1725	1811	1501
Q Serve(g_s), s	3.8	0.0	4.8	9.8	0.0	7.9	0.2	0.0	53.8	1.2	7.6	0.8
Cycle Q Clear(g_c), s	3.8	0.0	4.8	9.8	0.0	7.9	0.2	0.0	53.8	1.2	7.6	0.8
Prop In Lane	1.00		0.08	1.00		0.30	1.00		0.32	1.00		1.00
Lane Grp Cap(c), veh/h	248	0	149	325	0	247	661	0	1042	166	1121	929
V/C Ratio(X)	0.32	0.00	0.64	0.65	0.00	0.64	0.01	0.00	0.98	0.35	0.28	0.03
Avail Cap(c_a), veh/h	349	0	312	325	0	303	840	0	1042	285	1121	929
HCM Platoon Ratio	1.00	1.00	1.00	1.00	1.00	1.00	1.00	1.00	1.00	1.00	1.00	1.00
Upstream Filter(I)	1.00	0.00	1.00	1.00	0.00	1.00	1.00	0.00	1.00	1.00	1.00	1.00
Uniform Delay (d), s/veh	36.9	0.0	42.4	33.2	0.0	38.9	7.8	0.0	19.2	23.0	8.3	7.0
Incr Delay (d2), s/veh	0.3	0.0	1.7	3.5	0.0	1.6	0.0	0.0	23.8	0.5	0.2	0.0
Initial Q Delay(d3),s/veh	0.0	0.0	0.0	0.0	0.0	0.0	0.0	0.0	0.0	0.0	0.0	0.0
%ile BackOfQ(50%),veh/ln	1.7	0.0	2.2	4.5	0.0	3.6	0.1	0.0	26.4	0.8	2.8	0.2
Unsig. Movement Delay, s/veh												
LnGrp Delay(d),s/veh	37.1	0.0	44.1	36.7	0.0	40.6	7.8	0.0	43.0	23.4	8.6	7.1
LnGrp LOS	D	A	D	D	A	D	A	A	D	C	A	A
Approach Vol, veh/h		176			369			1033			404	
Approach Delay, s/veh		40.9			38.4			42.7			10.6	
Approach LOS		D			D			D			B	
Timer - Assigned Phs	1	2	3	4	5	6	7	8				
Phs Duration (G+Y+Rc), s	8.4	60.0	15.0	11.7	5.6	62.9	9.6	17.0				
Change Period (Y+Rc), s	4.5	5.0	4.5	4.5	4.5	5.0	4.5	4.5				
Max Green Setting (Gmax), s	10.5	55.0	10.5	15.5	10.5	55.0	10.5	15.5				
Max Q Clear Time (g_c+I1), s	3.2	55.8	11.8	6.8	2.2	9.6	5.8	9.9				
Green Ext Time (p_c), s	0.0	0.0	0.0	0.2	0.0	3.9	0.0	0.2				

Intersection Summary

HCM 6th Ctrl Delay	35.2
HCM 6th LOS	D

Notes

User approved pedestrian interval to be less than phase max green.

HCM 6th Signalized Intersection Summary

2: SW Boones Ferry Rd & SW Avery St

06/30/2021



Movement	EBL	EBT	EBR	WBL	WBT	WBR	NBL	NBT	NBR	SBL	SBT	SBR
Lane Configurations												
Traffic Volume (veh/h)	178	70	150	31	107	15	273	761	42	7	324	160
Future Volume (veh/h)	178	70	150	31	107	15	273	761	42	7	324	160
Initial Q (Qb), veh	0	0	0	0	0	0	0	0	0	0	0	0
Ped-Bike Adj(A_pbT)	1.00		0.97	0.99		0.96	1.00		0.98	1.00		1.00
Parking Bus, Adj	1.00	1.00	1.00	1.00	1.00	1.00	1.00	1.00	1.00	1.00	1.00	1.00
Work Zone On Approach		No			No			No			No	
Adj Sat Flow, veh/h/ln	1841	1841	1841	1841	1841	1841	1767	1767	1767	1841	1841	1841
Adj Flow Rate, veh/h	212	83	102	37	127	12	325	906	44	8	386	172
Peak Hour Factor	0.84	0.84	0.84	0.84	0.84	0.84	0.84	0.84	0.84	0.84	0.84	0.84
Percent Heavy Veh, %	4	4	4	4	4	4	9	9	9	4	4	4
Cap, veh/h	318	147	180	230	174	16	431	999	49	152	661	294
Arrive On Green	0.13	0.20	0.19	0.03	0.11	0.10	0.06	0.60	0.58	0.01	0.55	0.55
Sat Flow, veh/h	1753	738	907	1753	1649	156	1682	1669	81	1753	1205	537
Grp Volume(v), veh/h	212	0	185	37	0	139	325	0	950	8	0	558
Grp Sat Flow(s),veh/h/ln	1753	0	1645	1753	0	1805	1682	0	1750	1753	0	1742
Q Serve(g_s), s	10.4	0.0	10.1	1.9	0.0	7.4	6.0	0.0	47.5	0.2	0.0	21.2
Cycle Q Clear(g_c), s	10.4	0.0	10.1	1.9	0.0	7.4	6.0	0.0	47.5	0.2	0.0	21.2
Prop In Lane	1.00		0.55	1.00		0.09	1.00		0.05	1.00		0.31
Lane Grp Cap(c), veh/h	318	0	327	230	0	190	431	0	1047	152	0	955
V/C Ratio(X)	0.67	0.00	0.57	0.16	0.00	0.73	0.75	0.00	0.91	0.05	0.00	0.58
Avail Cap(c_a), veh/h	467	0	429	279	0	199	431	0	1160	240	0	1155
HCM Platoon Ratio	1.00	1.00	1.00	1.00	1.00	1.00	1.00	1.00	1.00	1.00	1.00	1.00
Upstream Filter(l)	1.00	0.00	1.00	1.00	0.00	1.00	1.00	0.00	1.00	1.00	0.00	1.00
Uniform Delay (d), s/veh	33.2	0.0	36.3	38.7	0.0	43.2	19.4	0.0	17.6	19.6	0.0	15.0
Incr Delay (d2), s/veh	0.9	0.0	0.6	0.1	0.0	10.4	6.6	0.0	10.1	0.1	0.0	0.8
Initial Q Delay(d3),s/veh	0.0	0.0	0.0	0.0	0.0	0.0	0.0	0.0	0.0	0.0	0.0	0.0
%ile BackOfQ(50%),veh/ln	4.4	0.0	4.1	0.8	0.0	3.8	4.8	0.0	20.1	0.1	0.0	8.1
Unsig. Movement Delay, s/veh												
LnGrp Delay(d),s/veh	34.1	0.0	36.9	38.8	0.0	53.7	26.0	0.0	27.7	19.7	0.0	15.8
LnGrp LOS	C	A	D	D	A	D	C	A	C	B	A	B
Approach Vol, veh/h		397			176			1275			566	
Approach Delay, s/veh		35.4			50.5			27.3			15.8	
Approach LOS		D			D			C			B	
Timer - Assigned Phs	1	2	3	4	5	6	7	8				
Phs Duration (G+Y+Rc), s	5.0	63.6	7.2	23.8	10.0	58.6	16.5	14.5				
Change Period (Y+Rc), s	4.0	5.5	4.0	5.0	4.0	5.5	4.0	5.0				
Max Green Setting (Gmax), s	6.0	64.5	6.0	25.0	6.0	64.5	21.0	10.0				
Max Q Clear Time (g_c+1/2), s	12.2	49.5	3.9	12.1	8.0	23.2	12.4	9.4				
Green Ext Time (p_c), s	0.0	8.6	0.0	0.5	0.0	6.5	0.1	0.0				

Intersection Summary

HCM 6th Ctrl Delay	27.6
HCM 6th LOS	C

Notes

User approved pedestrian interval to be less than phase max green.

HCM 6th Signalized Intersection Summary

3: SW Boones Ferry Road & SW Ibach Street/SW Ibach Court

06/30/2021



Movement	EBL	EBT	EBR	WBL	WBT	WBR	NBL	NBT	NBR	SBL	SBT	SBR
Lane Configurations												
Traffic Volume (veh/h)	262	4	345	4	1	19	140	799	10	3	416	87
Future Volume (veh/h)	262	4	345	4	1	19	140	799	10	3	416	87
Initial Q (Qb), veh	0	0	0	0	0	0	0	0	0	0	0	0
Ped-Bike Adj(A_pbT)	0.98		0.99	1.00		0.97	1.00		0.99	1.00		0.99
Parking Bus, Adj	1.00	1.00	1.00	1.00	1.00	1.00	1.00	1.00	1.00	1.00	1.00	1.00
Work Zone On Approach		No			No			No			No	
Adj Sat Flow, veh/h/ln	1856	1856	1856	1900	1900	1900	1796	1796	1796	1811	1811	1811
Adj Flow Rate, veh/h	301	5	225	5	1	5	161	918	11	3	478	54
Peak Hour Factor	0.87	0.87	0.87	0.87	0.87	0.87	0.87	0.87	0.87	0.87	0.87	0.87
Percent Heavy Veh, %	3	3	3	0	0	0	7	7	7	6	6	6
Cap, veh/h	419	10	430	156	46	118	193	1025	12	6	849	716
Arrive On Green	0.28	0.28	0.28	0.28	0.28	0.28	0.11	0.58	0.57	0.00	0.47	0.47
Sat Flow, veh/h	1370	34	1530	341	162	420	1711	1771	21	1725	1811	1527
Grp Volume(v), veh/h	301	0	230	11	0	0	161	0	929	3	478	54
Grp Sat Flow(s),veh/h/ln	1370	0	1564	923	0	0	1711	0	1792	1725	1811	1527
Q Serve(g_s), s	10.7	0.0	10.9	0.1	0.0	0.0	8.1	0.0	39.7	0.2	16.7	1.7
Cycle Q Clear(g_c), s	21.7	0.0	10.9	11.0	0.0	0.0	8.1	0.0	39.7	0.2	16.7	1.7
Prop In Lane	1.00		0.98	0.45		0.45	1.00		0.01	1.00		1.00
Lane Grp Cap(c), veh/h	419	0	439	314	0	0	193	0	1037	6	849	716
V/C Ratio(X)	0.72	0.00	0.52	0.04	0.00	0.00	0.83	0.00	0.90	0.54	0.56	0.08
Avail Cap(c_a), veh/h	441	0	465	336	0	0	215	0	1148	217	1160	978
HCM Platoon Ratio	1.00	1.00	1.00	1.00	1.00	1.00	1.00	1.00	1.00	1.00	1.00	1.00
Upstream Filter(I)	1.00	0.00	1.00	1.00	0.00	0.00	1.00	0.00	1.00	1.00	1.00	1.00
Uniform Delay (d), s/veh	31.3	0.0	26.7	23.3	0.0	0.0	38.0	0.0	16.1	43.5	16.8	12.8
Incr Delay (d2), s/veh	4.8	0.0	0.6	0.0	0.0	0.0	20.5	0.0	9.3	42.0	0.9	0.1
Initial Q Delay(d3),s/veh	0.0	0.0	0.0	0.0	0.0	0.0	0.0	0.0	0.0	0.0	0.0	0.0
%ile BackOfQ(50%),veh/ln	6.5	0.0	4.0	0.2	0.0	0.0	4.4	0.0	16.4	0.1	6.6	0.6
Unsig. Movement Delay, s/veh												
LnGrp Delay(d),s/veh	36.0	0.0	27.3	23.4	0.0	0.0	58.5	0.0	25.5	85.5	17.7	12.9
LnGrp LOS	D	A	C	C	A	A	E	A	C	F	B	B
Approach Vol, veh/h		531			11			1090			535	
Approach Delay, s/veh		32.3			23.4			30.4			17.6	
Approach LOS		C			C			C			B	
Timer - Assigned Phs	1	2		4	5	6		8				
Phs Duration (G+Y+Rc), s	4.3	54.6		28.6	13.9	45.0		28.6				
Change Period (Y+Rc), s	4.0	5.0		4.5	4.0	5.0		4.5				
Max Green Setting (Gmax), s	1.0	55.0		25.5	11.0	55.0		25.5				
Max Q Clear Time (g_c+1/2), s	12.2	41.7		23.7	10.1	18.7		13.0				
Green Ext Time (p_c), s	0.0	7.9		0.4	0.0	5.7		0.0				

Intersection Summary

HCM 6th Ctrl Delay	27.6
HCM 6th LOS	C

HCM 6th TWSC
4: SW Boones Ferry Road & SW Iowa Drive

06/30/2021

Intersection												
Int Delay, s/veh	14.9											
Movement	EBL	EBT	EBR	WBL	WBT	WBR	NBL	NBT	NBR	SBL	SBT	SBR
Lane Configurations		↕			↕		↕	↕		↕	↕	
Traffic Vol, veh/h	51	2	56	30	0	32	14	753	10	20	478	18
Future Vol, veh/h	51	2	56	30	0	32	14	753	10	20	478	18
Conflicting Peds, #/hr	13	0	5	1	0	9	5	0	1	9	0	13
Sign Control	Stop	Stop	Stop	Stop	Stop	Stop	Free	Free	Free	Free	Free	Free
RT Channelized	-	-	None	-	-	None	-	-	None	-	-	None
Storage Length	-	-	-	-	-	-	95	-	-	105	-	-
Veh in Median Storage, #	-	0	-	-	0	-	-	0	-	-	0	-
Grade, %	-	0	-	-	0	-	-	0	-	-	0	-
Peak Hour Factor	84	84	84	84	84	84	84	84	84	84	84	84
Heavy Vehicles, %	0	0	0	0	0	0	7	7	7	6	6	6
Mvmt Flow	61	2	67	36	0	38	17	896	12	24	569	21

Major/Minor	Minor2		Minor1		Major1			Major2				
Conflicting Flow All	1609	1592	598	1612	1596	924	603	0	0	917	0	0
Stage 1	641	641	-	945	945	-	-	-	-	-	-	-
Stage 2	968	951	-	667	651	-	-	-	-	-	-	-
Critical Hdwy	7.1	6.5	6.2	7.1	6.5	6.2	4.17	-	-	4.16	-	-
Critical Hdwy Stg 1	6.1	5.5	-	6.1	5.5	-	-	-	-	-	-	-
Critical Hdwy Stg 2	6.1	5.5	-	6.1	5.5	-	-	-	-	-	-	-
Follow-up Hdwy	3.5	4	3.3	3.5	4	3.3	2.263	-	-	2.254	-	-
Pot Cap-1 Maneuver	85	108	506	85	108	329	951	-	-	728	-	-
Stage 1	466	473	-	317	343	-	-	-	-	-	-	-
Stage 2	308	341	-	451	468	-	-	-	-	-	-	-
Platoon blocked, %								-	-	-	-	-
Mov Cap-1 Maneuver	70	100	497	69	100	322	939	-	-	722	-	-
Mov Cap-2 Maneuver	70	100	-	69	100	-	-	-	-	-	-	-
Stage 1	452	452	-	308	334	-	-	-	-	-	-	-
Stage 2	263	332	-	374	447	-	-	-	-	-	-	-

Approach	EB		WB		NB		SB	
HCM Control Delay, s	152.5		79		0.2		0.4	
HCM LOS	F		F					

Minor Lane/Major Mvmt	NBL	NBT	NBR	EBLn1WBLn1	SBL	SBT	SBR
Capacity (veh/h)	939	-	-	127	116	722	-
HCM Lane V/C Ratio	0.018	-	-	1.022	0.636	0.033	-
HCM Control Delay (s)	8.9	-	-	152.5	79	10.2	-
HCM Lane LOS	A	-	-	F	F	B	-
HCM 95th %tile Q(veh)	0.1	-	-	7.2	3.2	0.1	-

HCM 6th TWSC
 5: SW Boones Ferry Road & SW Norwood Road

06/30/2021

Intersection						
Int Delay, s/veh	5.5					
Movement	WBL	WBR	NBT	NBR	SBL	SBT
Lane Configurations	Y		↑	↑	↑	↑
Traffic Vol, veh/h	93	94	684	41	64	500
Future Vol, veh/h	93	94	684	41	64	500
Conflicting Peds, #/hr	4	4	0	4	4	0
Sign Control	Stop	Stop	Free	Free	Free	Free
RT Channelized	-	None	-	None	-	None
Storage Length	-	-	-	65	290	-
Veh in Median Storage, #	0	-	0	-	-	0
Grade, %	0	-	0	-	-	0
Peak Hour Factor	87	87	87	87	87	87
Heavy Vehicles, %	2	2	6	6	5	5
Mvmt Flow	107	108	786	47	74	575

Major/Minor	Minor1	Major1	Major2			
Conflicting Flow All	1517	794	0	0	837	0
Stage 1	790	-	-	-	-	-
Stage 2	727	-	-	-	-	-
Critical Hdwy	6.42	6.22	-	-	4.15	-
Critical Hdwy Stg 1	5.42	-	-	-	-	-
Critical Hdwy Stg 2	5.42	-	-	-	-	-
Follow-up Hdwy	3.518	3.318	-	-	2.245	-
Pot Cap-1 Maneuver	131	388	-	-	784	-
Stage 1	447	-	-	-	-	-
Stage 2	478	-	-	-	-	-
Platoon blocked, %			-	-		
Mov Cap-1 Maneuver	118	385	-	-	781	-
Mov Cap-2 Maneuver	254	-	-	-	-	-
Stage 1	445	-	-	-	-	-
Stage 2	431	-	-	-	-	-

Approach	WB	NB	SB
HCM Control Delay, s	40.4	0	1.1
HCM LOS	E		

Minor Lane/Major Mvmt	NBT	NBRWBLn1	SBL	SBT
Capacity (veh/h)	-	-	306	781
HCM Lane V/C Ratio	-	-	0.702	0.094
HCM Control Delay (s)	-	-	40.4	10.1
HCM Lane LOS	-	-	E	B
HCM 95th %tile Q(veh)	-	-	4.9	0.3

Intersection												
Int Delay, s/veh	2.6											
Movement	EBL	EBT	EBR	WBL	WBT	WBR	NBL	NBT	NBR	SBL	SBT	SBR
Lane Configurations		↕↔			↕	↕	↕	↕	↕	↕	↕	↕
Traffic Vol, veh/h	1	0	2	106	0	52	1	678	35	15	578	0
Future Vol, veh/h	1	0	2	106	0	52	1	678	35	15	578	0
Conflicting Peds, #/hr	0	0	0	4	0	4	0	0	4	4	0	0
Sign Control	Stop	Stop	Stop	Stop	Stop	Stop	Free	Free	Free	Free	Free	Free
RT Channelized	-	-	None	-	-	None	-	-	None	-	-	None
Storage Length	-	-	-	-	-	150	150	-	150	150	-	-
Veh in Median Storage, #	-	0	-	-	2	-	-	0	-	-	0	-
Grade, %	-	0	-	-	0	-	-	0	-	-	0	-
Peak Hour Factor	87	87	87	87	87	87	87	87	87	87	87	87
Heavy Vehicles, %	2	2	2	0	2	0	2	6	6	5	5	2
Mvmt Flow	1	0	2	122	0	60	1	779	40	17	664	0

Major/Minor	Minor2		Minor1		Major1		Major2					
Conflicting Flow All	1533	1523	668	1488	1483	787	664	0	0	823	0	0
Stage 1	698	698	-	785	785	-	-	-	-	-	-	-
Stage 2	835	825	-	703	698	-	-	-	-	-	-	-
Critical Hdwy	7.12	6.52	6.22	7.1	6.52	6.2	4.12	-	-	4.15	-	-
Critical Hdwy Stg 1	6.12	5.52	-	6.1	5.52	-	-	-	-	-	-	-
Critical Hdwy Stg 2	6.12	5.52	-	6.1	5.52	-	-	-	-	-	-	-
Follow-up Hdwy	3.518	4.018	3.318	3.5	4.018	3.3	2.218	-	-	2.245	-	-
Pot Cap-1 Maneuver	95	118	458	~103	125	395	925	-	-	794	-	-
Stage 1	431	442	-	389	404	-	-	-	-	-	-	-
Stage 2	362	387	-	431	442	-	-	-	-	-	-	-
Platoon blocked, %								-	-	-	-	-
Mov Cap-1 Maneuver	79	115	456	~100	122	392	925	-	-	791	-	-
Mov Cap-2 Maneuver	79	115	-	285	302	-	-	-	-	-	-	-
Stage 1	431	433	-	387	402	-	-	-	-	-	-	-
Stage 2	305	385	-	418	433	-	-	-	-	-	-	-

Approach	EB		WB		NB		SB	
HCM Control Delay, s	25.9		23.1		0		0.2	
HCM LOS	D		C					

Minor Lane/Major Mvmt	NBL	NBT	NBR	EBLn1	WBLn1	WBLn2	SBL	SBT	SBR
Capacity (veh/h)	925	-	-	176	285	392	791	-	-
HCM Lane V/C Ratio	0.001	-	-	0.02	0.428	0.152	0.022	-	-
HCM Control Delay (s)	8.9	-	-	25.9	26.7	15.8	9.7	-	-
HCM Lane LOS	A	-	-	D	D	C	A	-	-
HCM 95th %tile Q(veh)	0	-	-	0.1	2	0.5	0.1	-	-

Notes
 ~: Volume exceeds capacity \$: Delay exceeds 300s +: Computation Not Defined *: All major volume in platoon

HCM 6th Signalized Intersection Summary

7: SW Boones Ferry Road & Basalt Creek Parkway Extension

06/30/2021



Movement	EBL	EBR	NBL	NBT	SBT	SBR
Lane Configurations						
Traffic Volume (veh/h)	153	291	321	557	608	75
Future Volume (veh/h)	153	291	321	557	608	75
Initial Q (Qb), veh	0	0	0	0	0	0
Ped-Bike Adj(A_pbT)	1.00	1.00	1.00			1.00
Parking Bus, Adj	1.00	1.00	1.00	1.00	1.00	1.00
Work Zone On Approach	No			No	No	
Adj Sat Flow, veh/h/ln	1900	1900	1811	1811	1826	1826
Adj Flow Rate, veh/h	176	334	369	640	699	86
Peak Hour Factor	0.87	0.87	0.87	0.87	0.87	0.87
Percent Heavy Veh, %	0	0	6	6	5	5
Cap, veh/h	305	627	381	1354	772	95
Arrive On Green	0.17	0.17	0.44	1.00	0.48	0.47
Sat Flow, veh/h	1810	1610	1725	1811	1594	196
Grp Volume(v), veh/h	176	334	369	640	0	785
Grp Sat Flow(s),veh/h/ln	1810	1610	1725	1811	0	1790
Q Serve(g_s), s	8.5	15.2	19.8	0.0	0.0	38.3
Cycle Q Clear(g_c), s	8.5	15.2	19.8	0.0	0.0	38.3
Prop In Lane	1.00	1.00	1.00			0.11
Lane Grp Cap(c), veh/h	305	627	381	1354	0	867
V/C Ratio(X)	0.58	0.53	0.97	0.47	0.00	0.91
Avail Cap(c_a), veh/h	305	627	381	1354	0	867
HCM Platoon Ratio	1.00	1.00	2.00	2.00	1.00	1.00
Upstream Filter(I)	1.00	1.00	0.73	0.73	0.00	1.00
Uniform Delay (d), s/veh	36.4	22.3	26.2	0.0	0.0	22.6
Incr Delay (d2), s/veh	2.3	0.7	31.1	0.9	0.0	14.8
Initial Q Delay(d3),s/veh	0.0	0.0	0.0	0.0	0.0	0.0
%ile BackOfQ(50%),veh/ln	3.9	14.3	9.1	0.3	0.0	18.6
Unsig. Movement Delay, s/veh						
LnGrp Delay(d),s/veh	38.7	23.0	57.3	0.9	0.0	37.4
LnGrp LOS	D	C	E	A	A	D
Approach Vol, veh/h	510			1009	785	
Approach Delay, s/veh	28.4			21.5	37.4	
Approach LOS	C			C	D	
Timer - Assigned Phs		2		4	5	6
Phs Duration (G+Y+Rc), s		75.0		20.0	25.0	50.0
Change Period (Y+Rc), s		* 5.4		4.5	4.5	* 5.4
Max Green Setting (Gmax), s		* 70		15.5	20.5	* 45
Max Q Clear Time (g_c+I1), s		2.0		17.2	21.8	40.3
Green Ext Time (p_c), s		9.4		0.0	0.0	2.7

Intersection Summary

HCM 6th Ctrl Delay	28.5
HCM 6th LOS	C

Notes

User approved pedestrian interval to be less than phase max green.

* HCM 6th computational engine requires equal clearance times for the phases crossing the barrier.

HCM 6th Signalized Intersection Summary

8: SW Boones Ferry Road & SW Day Road

06/30/2021



Movement	EBL	EBT	EBR	WBL	WBT	WBR	NBL	NBT	NBR	SBL	SBT	SBR
Lane Configurations		↕	↗		↕		↗	↖		↖	↕	↗
Traffic Volume (veh/h)	37	0	290	0	0	0	321	841	0	0	885	15
Future Volume (veh/h)	37	0	290	0	0	0	321	841	0	0	885	15
Initial Q (Qb), veh	0	0	0	0	0	0	0	0	0	0	0	0
Ped-Bike Adj(A_pbT)	1.00		1.00	1.00		1.00	1.00		1.00	1.00		1.00
Parking Bus, Adj	1.00	1.00	1.00	1.00	1.00	1.00	1.00	1.00	1.00	1.00	1.00	1.00
Work Zone On Approach		No			No			No			No	
Adj Sat Flow, veh/h/ln	1693	1693	1693	1900	1900	1900	1693	1693	1693	1796	1796	1796
Adj Flow Rate, veh/h	41	0	272	0	0	0	357	934	0	0	983	6
Peak Hour Factor	0.90	0.90	0.90	0.90	0.90	0.90	0.90	0.90	0.90	0.90	0.90	0.90
Percent Heavy Veh, %	14	14	14	0	0	0	14	14	14	7	7	7
Cap, veh/h	285	0	467	0	316	0	436	979	0	201	1874	11
Arrive On Green	0.16	0.00	0.17	0.00	0.00	0.00	0.21	0.77	0.00	0.00	1.00	1.00
Sat Flow, veh/h	1283	0	1434	0	1900	0	2740	1693	0	1711	3478	21
Grp Volume(v), veh/h	41	0	272	0	0	0	357	934	0	0	482	507
Grp Sat Flow(s),veh/h/ln	1283	0	1434	0	1900	0	1370	1693	0	1711	1706	1792
Q Serve(g_s), s	2.6	0.0	15.0	0.0	0.0	0.0	11.8	45.5	0.0	0.0	0.0	0.0
Cycle Q Clear(g_c), s	2.6	0.0	15.0	0.0	0.0	0.0	11.8	45.5	0.0	0.0	0.0	0.0
Prop In Lane	1.00		1.00	0.00		0.00	1.00		0.00	1.00		0.01
Lane Grp Cap(c), veh/h	282	0	467	0	316	0	436	979	0	201	919	966
V/C Ratio(X)	0.15	0.00	0.58	0.00	0.00	0.00	0.82	0.95	0.00	0.00	0.52	0.52
Avail Cap(c_a), veh/h	282	0	467	0	320	0	1047	1033	0	201	919	966
HCM Platoon Ratio	1.00	1.00	1.00	1.00	1.00	1.00	1.33	1.33	1.33	2.00	2.00	2.00
Upstream Filter(I)	1.00	0.00	1.00	0.00	0.00	0.00	0.89	0.89	0.00	0.00	0.55	0.55
Uniform Delay (d), s/veh	34.5	0.0	26.7	0.0	0.0	0.0	36.1	9.9	0.0	0.0	0.0	0.0
Incr Delay (d2), s/veh	0.2	0.0	1.6	0.0	0.0	0.0	2.1	18.2	0.0	0.0	1.2	1.1
Initial Q Delay(d3),s/veh	0.0	0.0	0.0	0.0	0.0	0.0	0.0	0.0	0.0	0.0	0.0	0.0
%ile BackOfQ(50%),veh/ln	0.8	0.0	5.1	0.0	0.0	0.0	3.8	11.8	0.0	0.0	0.3	0.3
Unsig. Movement Delay, s/veh												
LnGrp Delay(d),s/veh	34.6	0.0	28.3	0.0	0.0	0.0	38.3	28.1	0.0	0.0	1.2	1.1
LnGrp LOS	C	A	C	A	A	A	D	C	A	A	A	A
Approach Vol, veh/h		313			0			1291			989	
Approach Delay, s/veh		29.1			0.0			30.9			1.2	
Approach LOS		C						C			A	
Timer - Assigned Phs	1	2		4	5	6		8				
Phs Duration (G+Y+Rc), s	19.8	55.2		20.0	16.1	58.9		20.0				
Change Period (Y+Rc), s	5.2	* 5.4		* 4.7	* 5.4	* 5.4		* 4.7				
Max Green Setting (Gmax), s	35.8	* 29		* 16	* 8.5	* 57		* 15				
Max Q Clear Time (g_c+1), s	13.8	2.0		0.0	0.0	47.5		17.0				
Green Ext Time (p_c), s	0.8	10.5		0.0	0.0	6.0		0.0				

Intersection Summary

HCM 6th Ctrl Delay	19.3
HCM 6th LOS	B

Notes

User approved pedestrian interval to be less than phase max green.

* HCM 6th computational engine requires equal clearance times for the phases crossing the barrier.

HCM 6th Signalized Intersection Summary

9: SW Elligsen Road/SW Boones Ferry Road & SW 95th Avenue

06/30/2021



Movement	EBL	EBT	EBR	WBL	WBT	WBR	NBL	NBT	NBR	SBL	SBT	SBR
Lane Configurations		↕	↗	↖	↗	↖	↗	↖		↖	↗	↖
Traffic Volume (veh/h)	208	8	560	17	1	7	846	866	70	6	814	273
Future Volume (veh/h)	208	8	560	17	1	7	846	866	70	6	814	273
Initial Q (Qb), veh	0	0	0	0	0	0	0	0	0	0	0	0
Ped-Bike Adj(A_pbT)	1.00		1.00	1.00		1.00	1.00		1.00	1.00		1.00
Parking Bus, Adj	1.00	1.00	1.00	1.00	1.00	1.00	1.00	1.00	1.00	1.00	1.00	1.00
Work Zone On Approach		No		No		No		No		No		No
Adj Sat Flow, veh/h/ln	1648	1648	1648	1737	1737	1737	1796	1796	1796	1737	1737	1737
Adj Flow Rate, veh/h	226	9	571	18	1	8	920	941	76	7	885	0
Peak Hour Factor	0.92	0.92	0.92	0.92	0.92	0.92	0.92	0.92	0.92	0.92	0.92	0.92
Percent Heavy Veh, %	17	17	17	11	11	11	7	7	7	11	11	11
Cap, veh/h	296	9	1225	76	32	252	1025	1233	100	442	1135	
Arrive On Green	0.19	0.19	0.19	0.19	0.19	0.19	0.52	0.64	0.64	0.09	0.11	0.00
Sat Flow, veh/h	1172	47	2458	775	166	1331	3319	3198	258	1654	3300	1472
Grp Volume(v), veh/h	235	0	571	18	0	9	920	502	515	7	885	0
Grp Sat Flow(s),veh/h/ln	1218	0	1229	775	0	1497	1659	1706	1750	1654	1650	1472
Q Serve(g_s), s	17.5	0.0	14.4	0.0	0.0	0.5	23.8	19.6	19.6	0.4	24.8	0.0
Cycle Q Clear(g_c), s	18.0	0.0	14.4	18.0	0.0	0.5	23.8	19.6	19.6	0.4	24.8	0.0
Prop In Lane	0.96		1.00	1.00		0.89	1.00		0.15	1.00		1.00
Lane Grp Cap(c), veh/h	305	0	1225	76	0	284	1025	658	675	442	1135	
V/C Ratio(X)	0.77	0.00	0.47	0.24	0.00	0.03	0.90	0.76	0.76	0.02	0.78	
Avail Cap(c_a), veh/h	305	0	1225	76	0	284	1572	988	1013	442	1135	
HCM Platoon Ratio	1.00	1.00	1.00	1.00	1.00	1.00	1.67	1.67	1.67	0.33	0.33	0.33
Upstream Filter(I)	1.00	0.00	1.00	1.00	0.00	1.00	0.16	0.16	0.16	0.83	0.83	0.00
Uniform Delay (d), s/veh	38.9	0.0	15.6	47.5	0.0	31.4	21.7	13.9	13.9	31.9	38.6	0.0
Incr Delay (d2), s/veh	11.0	0.0	0.2	1.2	0.0	0.0	0.8	1.4	1.4	0.0	4.5	0.0
Initial Q Delay(d3),s/veh	0.0	0.0	0.0	0.0	0.0	0.0	0.0	0.0	0.0	0.0	0.0	0.0
%ile BackOfQ(50%),veh/ln	6.3	0.0	3.9	0.4	0.0	0.2	6.6	4.8	5.0	0.1	11.6	0.0
Unsig. Movement Delay, s/veh												
LnGrp Delay(d),s/veh	49.8	0.0	15.8	48.7	0.0	31.4	22.5	15.3	15.2	31.9	43.1	0.0
LnGrp LOS	D	A	B	D	A	C	C	B	B	C	D	
Approach Vol, veh/h		806			27			1937			892	A
Approach Delay, s/veh		25.7			42.9			18.7			43.0	
Approach LOS		C			D			B			D	
Timer - Assigned Phs	1	2		4	5	6		8				
Phs Duration (G+Y+Rc), s	34.3	37.7		23.0	30.4	41.6		23.0				
Change Period (Y+Rc), s	5.0	5.0		5.0	5.0	5.0		5.0				
Max Green Setting (Gmax), s	45.0	17.0		18.0	7.0	55.0		18.0				
Max Q Clear Time (g_c+Q), s	25.8	26.8		20.0	2.4	21.6		20.0				
Green Ext Time (p_c), s	3.6	0.0		0.0	0.0	15.1		0.0				

Intersection Summary

HCM 6th Ctrl Delay	26.3
HCM 6th LOS	C

Notes

- User approved pedestrian interval to be less than phase max green.
- Unsignalized Delay for [SBR] is excluded from calculations of the approach delay and intersection delay.

HCM Signalized Intersection Capacity Analysis

10: I-5 SB Ramps & SW Elligsen Road

06/27/2021



Movement	EBL	EBT	EBR	WBL	WBT	WBR	NBL	NBT	NBR	SBL	SBT	SBR
Lane Configurations		↑↑	↗		↑↑	↗				↘	↖	↗
Traffic Volume (vph)	0	1011	379	0	755	121	0	0	0	540	0	1025
Future Volume (vph)	0	1011	379	0	755	121	0	0	0	540	0	1025
Ideal Flow (vphpl)	1900	1900	1900	1900	1900	1900	1900	1900	1900	1900	1900	1900
Lane Width	12	12	12	12	12	12	12	12	12	12	12	16
Total Lost time (s)		4.0	4.0		4.0	4.0				4.0	4.0	4.0
Lane Util. Factor		0.95	1.00		0.95	1.00				0.95	0.95	1.00
Frbp, ped/bikes		1.00	0.99		1.00	1.00				1.00	1.00	1.00
Flpb, ped/bikes		1.00	1.00		1.00	1.00				1.00	1.00	1.00
Frt		1.00	0.85		1.00	0.85				1.00	1.00	0.85
Flt Protected		1.00	1.00		1.00	1.00				0.95	0.95	1.00
Satd. Flow (prot)		3034	1340		3406	1524				1573	1573	1679
Flt Permitted		1.00	1.00		1.00	1.00				0.95	0.95	1.00
Satd. Flow (perm)		3034	1340		3406	1524				1573	1573	1679
Peak-hour factor, PHF	0.94	0.94	0.94	0.94	0.94	0.94	0.94	0.94	0.94	0.94	0.94	0.94
Adj. Flow (vph)	0	1076	403	0	803	129	0	0	0	574	0	1090
RTOR Reduction (vph)	0	0	0	0	0	0	0	0	0	0	0	8
Lane Group Flow (vph)	0	1076	403	0	803	129	0	0	0	287	287	1082
Confl. Peds. (#/hr)			2									
Heavy Vehicles (%)	19%	19%	19%	6%	6%	6%	0%	0%	0%	9%	9%	9%
Turn Type		NA	Free		NA	Free				Split	NA	custom
Protected Phases		2			6					4	4	5
Permitted Phases			Free		6	Free						4
Actuated Green, G (s)		64.5	95.0		21.2	95.0				21.0	21.0	59.8
Effective Green, g (s)		65.5	95.0		22.2	95.0				21.5	21.5	60.8
Actuated g/C Ratio		0.69	1.00		0.23	1.00				0.23	0.23	0.64
Clearance Time (s)		5.0			5.0					4.5	4.5	4.5
Vehicle Extension (s)		4.1			4.1					2.3	2.3	2.3
Lane Grp Cap (vph)		2091	1340		795	1524				355	355	1145
v/s Ratio Prot		0.35			c0.24					0.18	0.18	c0.39
v/s Ratio Perm			0.30			0.08						0.25
v/c Ratio		0.51	0.30		1.01	0.08				0.81	0.81	0.94
Uniform Delay, d1		7.1	0.0		36.4	0.0				34.8	34.8	15.6
Progression Factor		2.28	1.00		0.64	1.00				1.00	1.00	1.00
Incremental Delay, d2		0.7	0.5		32.5	0.1				12.2	12.2	15.1
Delay (s)		16.9	0.5		55.8	0.1				47.0	47.0	30.6
Level of Service		B	A		E	A				D	D	C
Approach Delay (s)		12.4			48.1			0.0			36.3	
Approach LOS		B			D			A			D	
Intersection Summary												
HCM 2000 Control Delay			30.3									HCM 2000 Level of Service C
HCM 2000 Volume to Capacity ratio			1.01									
Actuated Cycle Length (s)			95.0							12.0		
Intersection Capacity Utilization			91.0%									ICU Level of Service F
Analysis Period (min)			15									
c Critical Lane Group												

V/C Ratio calculated using HCM worksheet with correct lost time

HCM 6th Signalized Intersection Summary

11: I-5 NB Ramps & SW Elligsen Road

06/30/2021

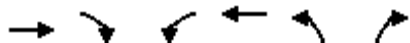

Movement	EBT	EBR	WBL	WBT	NBL	NBR
Lane Configurations	↑↑	↑		↑↑	↑↑	↑
Traffic Volume (veh/h)	784	768	0	342	533	265
Future Volume (veh/h)	784	768	0	342	533	265
Initial Q (Qb), veh	0	0	0	0	0	0
Ped-Bike Adj(A_pbT)		1.00	1.00		1.00	1.00
Parking Bus, Adj	1.00	1.00	1.00	1.00	1.00	1.00
Work Zone On Approach	No			No	No	
Adj Sat Flow, veh/h/ln	1707	1707	0	1796	1811	1811
Adj Flow Rate, veh/h	862	0	0	376	586	0
Peak Hour Factor	0.91	0.91	0.91	0.91	0.91	0.91
Percent Heavy Veh, %	13	13	0	7	6	6
Cap, veh/h	2311		0	2432	680	
Arrive On Green	0.24	0.00	0.00	0.71	0.20	0.00
Sat Flow, veh/h	3329	1447	0	3593	3346	1535
Grp Volume(v), veh/h	862	0	0	376	586	0
Grp Sat Flow(s),veh/h/ln	1622	1447	0	1706	1673	1535
Q Serve(g_s), s	21.2	0.0	0.0	3.4	16.1	0.0
Cycle Q Clear(g_c), s	21.2	0.0	0.0	3.4	16.1	0.0
Prop In Lane		1.00	0.00		1.00	1.00
Lane Grp Cap(c), veh/h	2311		0	2432	680	
V/C Ratio(X)	0.37		0.00	0.15	0.86	
Avail Cap(c_a), veh/h	2311		0	2432	810	
HCM Platoon Ratio	0.33	0.33	1.00	1.00	1.00	1.00
Upstream Filter(l)	0.79	0.00	0.00	1.00	1.00	0.00
Uniform Delay (d), s/veh	18.5	0.0	0.0	4.4	36.6	0.0
Incr Delay (d2), s/veh	0.4	0.0	0.0	0.1	7.6	0.0
Initial Q Delay(d3),s/veh	0.0	0.0	0.0	0.0	0.0	0.0
%ile BackOfQ(50%),veh/ln	0.2	0.0	0.0	1.0	7.2	0.0
Unsig. Movement Delay, s/veh						
LnGrp Delay(d),s/veh	18.9	0.0	0.0	4.5	44.2	0.0
LnGrp LOS	B		A	A	D	
Approach Vol, veh/h	862	A		376	586	A
Approach Delay, s/veh	18.9			4.5	44.2	
Approach LOS	B			A	D	
Timer - Assigned Phs		2			6	8
Phs Duration (G+Y+Rc), s		71.7			71.7	23.3
Change Period (Y+Rc), s		5.0			5.0	4.5
Max Green Setting (Gmax), s		63.0			63.0	22.5
Max Q Clear Time (g_c+I1), s		23.2			5.4	18.1
Green Ext Time (p_c), s		10.7			4.0	0.7

Intersection Summary

HCM 6th Ctrl Delay	24.1
HCM 6th LOS	C

Notes

Unsignalized Delay for [NBR, EBR] is excluded from calculations of the approach delay and intersection delay.

HCM 6th TWSC
 12: Site Access/SW 89th Avenue & SW Norwood Road

06/30/2021

Intersection												
Int Delay, s/veh	2.2											
Movement	EBL	EBT	EBR	WBL	WBT	WBR	NBL	NBT	NBR	SBL	SBT	SBR
Lane Configurations		↕			↕			↕			↕	
Traffic Vol, veh/h	14	120	6	1	177	2	18	0	4	19	0	26
Future Vol, veh/h	14	120	6	1	177	2	18	0	4	19	0	26
Conflicting Peds, #/hr	1	0	0	0	0	2	0	0	0	2	0	1
Sign Control	Free	Free	Free	Free	Free	Free	Stop	Stop	Stop	Stop	Stop	Stop
RT Channelized	-	-	None	-	-	None	-	-	None	-	-	None
Storage Length	-	-	-	-	-	-	-	-	-	-	-	-
Veh in Median Storage, #	-	0	-	-	0	-	-	0	-	-	0	-
Grade, %	-	0	-	-	0	-	-	0	-	-	0	-
Peak Hour Factor	80	80	80	80	80	80	80	80	80	80	80	80
Heavy Vehicles, %	0	0	2	2	2	2	2	2	2	0	2	0
Mvmt Flow	18	150	8	1	221	3	23	0	5	24	0	33

Major/Minor	Major1			Major2			Minor1			Minor2		
Conflicting Flow All	226	0	0	158	0	0	432	418	156	422	421	226
Stage 1	-	-	-	-	-	-	190	190	-	227	227	-
Stage 2	-	-	-	-	-	-	242	228	-	195	194	-
Critical Hdwy	4.1	-	-	4.12	-	-	7.12	6.52	6.22	7.1	6.52	6.2
Critical Hdwy Stg 1	-	-	-	-	-	-	6.12	5.52	-	6.1	5.52	-
Critical Hdwy Stg 2	-	-	-	-	-	-	6.12	5.52	-	6.1	5.52	-
Follow-up Hdwy	2.2	-	-	2.218	-	-	3.518	4.018	3.318	3.5	4.018	3.3
Pot Cap-1 Maneuver	1354	-	-	1422	-	-	534	526	890	546	524	818
Stage 1	-	-	-	-	-	-	812	743	-	780	716	-
Stage 2	-	-	-	-	-	-	762	715	-	811	740	-
Platoon blocked, %	-	-	-	-	-	-	-	-	-	-	-	-
Mov Cap-1 Maneuver	1351	-	-	1422	-	-	506	517	888	535	515	816
Mov Cap-2 Maneuver	-	-	-	-	-	-	506	517	-	535	515	-
Stage 1	-	-	-	-	-	-	800	732	-	767	714	-
Stage 2	-	-	-	-	-	-	730	713	-	793	729	-

Approach	EB	WB	NB	SB
HCM Control Delay, s	0.8	0	11.9	10.9
HCM LOS			B	B

Minor Lane/Major Mvmt	NBLn1	EBL	EBT	EBR	WBL	WBT	WBR	SBLn1
Capacity (veh/h)	549	1351	-	-	1422	-	-	668
HCM Lane V/C Ratio	0.05	0.013	-	-	0.001	-	-	0.084
HCM Control Delay (s)	11.9	7.7	0	-	7.5	0	-	10.9
HCM Lane LOS	B	A	A	-	A	A	-	B
HCM 95th %tile Q(veh)	0.2	0	-	-	0	-	-	0.3

Intersection												
Int Delay, s/veh	4.4											
Movement	EBL	EBT	EBR	WBL	WBT	WBR	NBL	NBT	NBR	SBL	SBT	SBR
Lane Configurations		↕			↕			↕			↕	
Traffic Vol, veh/h	21	111	10	9	106	7	29	0	26	40	0	45
Future Vol, veh/h	21	111	10	9	106	7	29	0	26	40	0	45
Conflicting Peds, #/hr	0	0	0	0	0	0	0	0	0	0	0	0
Sign Control	Free	Free	Free	Free	Free	Free	Stop	Stop	Stop	Stop	Stop	Stop
RT Channelized	-	-	None	-	-	None	-	-	None	-	-	None
Storage Length	-	-	-	-	-	-	-	-	-	-	-	-
Veh in Median Storage, #	-	0	-	-	0	-	-	0	-	-	0	-
Grade, %	-	0	-	-	0	-	-	0	-	-	0	-
Peak Hour Factor	81	81	81	81	81	81	81	81	81	81	81	81
Heavy Vehicles, %	0	0	2	2	3	3	2	2	2	0	2	0
Mvmt Flow	26	137	12	11	131	9	36	0	32	49	0	56

Major/Minor	Major1			Major2			Minor1			Minor2		
Conflicting Flow All	140	0	0	149	0	0	381	357	143	369	359	136
Stage 1	-	-	-	-	-	-	195	195	-	158	158	-
Stage 2	-	-	-	-	-	-	186	162	-	211	201	-
Critical Hdwy	4.1	-	-	4.12	-	-	7.12	6.52	6.22	7.1	6.52	6.2
Critical Hdwy Stg 1	-	-	-	-	-	-	6.12	5.52	-	6.1	5.52	-
Critical Hdwy Stg 2	-	-	-	-	-	-	6.12	5.52	-	6.1	5.52	-
Follow-up Hdwy	2.2	-	-	2.218	-	-	3.518	4.018	3.318	3.5	4.018	3.3
Pot Cap-1 Maneuver	1456	-	-	1432	-	-	577	569	905	591	568	918
Stage 1	-	-	-	-	-	-	807	739	-	849	767	-
Stage 2	-	-	-	-	-	-	816	764	-	796	735	-
Platoon blocked, %	-	-	-	-	-	-	-	-	-	-	-	-
Mov Cap-1 Maneuver	1456	-	-	1432	-	-	531	553	905	558	552	918
Mov Cap-2 Maneuver	-	-	-	-	-	-	531	553	-	558	552	-
Stage 1	-	-	-	-	-	-	791	724	-	832	761	-
Stage 2	-	-	-	-	-	-	760	758	-	752	720	-

Approach	EB			WB			NB			SB		
HCM Control Delay, s	1.1			0.6			11.1			11		
HCM LOS							B			B		

Minor Lane/Major Mvmt	NBLn1	EBL	EBT	EBR	WBL	WBT	WBR	SBLn1
Capacity (veh/h)	660	1456	-	-	1432	-	-	704
HCM Lane V/C Ratio	0.103	0.018	-	-	0.008	-	-	0.149
HCM Control Delay (s)	11.1	7.5	0	-	7.5	0	-	11
HCM Lane LOS	B	A	A	-	A	A	-	B
HCM 95th %tile Q(veh)	0.3	0.1	-	-	0	-	-	0.5

HCM 6th TWSC
 14: SW 82nd Avenue & SW Norwood Road/Driveway

06/30/2021

Intersection												
Int Delay, s/veh	7.5											
Movement	EBL	EBT	EBR	WBL	WBT	WBR	NBL	NBT	NBR	SBL	SBT	SBR
Lane Configurations		↕			↕			↕			↕	↗
Traffic Vol, veh/h	152	0	25	0	0	0	37	4	0	0	0	85
Future Vol, veh/h	152	0	25	0	0	0	37	4	0	0	0	85
Conflicting Peds, #/hr	0	0	0	0	0	0	0	0	0	0	0	0
Sign Control	Free	Free	Free	Free	Free	Free	Stop	Stop	Stop	Stop	Stop	Stop
RT Channelized	-	-	None	-	-	None	-	-	None	-	-	Free
Storage Length	-	-	-	-	-	-	-	-	-	-	-	15
Veh in Median Storage, #	-	0	-	-	0	-	-	0	-	-	0	-
Grade, %	-	0	-	-	0	-	-	0	-	-	0	-
Peak Hour Factor	89	89	89	89	89	89	89	89	89	89	89	89
Heavy Vehicles, %	2	2	2	0	0	0	6	6	6	10	10	10
Mvmt Flow	171	0	28	0	0	0	42	4	0	0	0	96

Major/Minor	Major1			Major2			Minor1			Minor2		
Conflicting Flow All	1	0	0	28	0	0	357	357	14	359	371	-
Stage 1	-	-	-	-	-	-	356	356	-	1	1	-
Stage 2	-	-	-	-	-	-	1	1	-	358	370	-
Critical Hdwy	4.12	-	-	4.1	-	-	7.16	6.56	6.26	7.2	6.6	-
Critical Hdwy Stg 1	-	-	-	-	-	-	6.16	5.56	-	6.2	5.6	-
Critical Hdwy Stg 2	-	-	-	-	-	-	6.16	5.56	-	6.2	5.6	-
Follow-up Hdwy	2.218	-	-	2.2	-	-	3.554	4.054	3.354	3.59	4.09	-
Pot Cap-1 Maneuver	1622	-	-	1599	-	-	591	563	1054	582	546	0
Stage 1	-	-	-	-	-	-	653	622	-	1002	879	0
Stage 2	-	-	-	-	-	-	1012	887	-	644	606	0
Platoon blocked, %	-	-	-	-	-	-	-	-	-	-	-	-
Mov Cap-1 Maneuver	1622	-	-	1599	-	-	543	503	1054	531	488	-
Mov Cap-2 Maneuver	-	-	-	-	-	-	543	503	-	531	488	-
Stage 1	-	-	-	-	-	-	583	555	-	895	879	-
Stage 2	-	-	-	-	-	-	1012	887	-	570	541	-

Approach	EB			WB			NB			SB		
HCM Control Delay, s	6.4			0			12.3			0		
HCM LOS							B			A		

Minor Lane/Major Mvmt	NBLn1	EBL	EBT	EBR	WBL	WBT	WBR	SBLn1	SBLn2
Capacity (veh/h)	539	1622	-	-	1599	-	-	-	-
HCM Lane V/C Ratio	0.085	0.105	-	-	-	-	-	-	-
HCM Control Delay (s)	12.3	7.5	0	-	0	-	-	0	0
HCM Lane LOS	B	A	A	-	A	-	-	A	A
HCM 95th %tile Q(veh)	0.3	0.4	-	-	0	-	-	-	-

HCM 6th TWSC
 15: SW 65th Avenue & SW Norwood Road

06/30/2021

Intersection						
Int Delay, s/veh	6.7					
Movement	EBL	EBR	NBL	NBT	SBT	SBR
Lane Configurations	T			T		
Traffic Vol, veh/h	154	62	43	351	244	69
Future Vol, veh/h	154	62	43	351	244	69
Conflicting Peds, #/hr	2	2	2	0	0	2
Sign Control	Stop	Stop	Free	Free	Free	Free
RT Channelized	-	None	-	None	-	None
Storage Length	-	-	-	-	-	-
Veh in Median Storage, #	0	-	-	0	0	-
Grade, %	0	-	-	0	0	-
Peak Hour Factor	90	90	90	90	90	90
Heavy Vehicles, %	2	2	2	2	6	6
Mvmt Flow	171	69	48	390	271	77

Major/Minor	Minor2	Major1		Major2	
Conflicting Flow All	800	314	350	0	0
Stage 1	312	-	-	-	-
Stage 2	488	-	-	-	-
Critical Hdwy	6.42	6.22	4.12	-	-
Critical Hdwy Stg 1	5.42	-	-	-	-
Critical Hdwy Stg 2	5.42	-	-	-	-
Follow-up Hdwy	3.518	3.318	2.218	-	-
Pot Cap-1 Maneuver	354	726	1209	-	-
Stage 1	742	-	-	-	-
Stage 2	617	-	-	-	-
Platoon blocked, %				-	-
Mov Cap-1 Maneuver	335	723	1207	-	-
Mov Cap-2 Maneuver	335	-	-	-	-
Stage 1	703	-	-	-	-
Stage 2	616	-	-	-	-

Approach	EB	NB	SB
HCM Control Delay, s	27.1	0.9	0
HCM LOS	D		

Minor Lane/Major Mvmt	NBL	NBT	EBLn1	SBT	SBR
Capacity (veh/h)	1207	-	396	-	-
HCM Lane V/C Ratio	0.04	-	0.606	-	-
HCM Control Delay (s)	8.1	0	27.1	-	-
HCM Lane LOS	A	A	D	-	-
HCM 95th %tile Q(veh)	0.1	-	3.9	-	-

HCM 6th Signalized Intersection Summary

1: SW Boones Ferry Rd & SW Sagert St

06/30/2021



Movement	EBL	EBT	EBR	WBL	WBT	WBR	NBL	NBT	NBR	SBL	SBT	SBR
Lane Configurations												
Traffic Volume (veh/h)	56	173	10	250	98	43	22	399	318	90	689	61
Future Volume (veh/h)	56	173	10	250	98	43	22	399	318	90	689	61
Initial Q (Qb), veh	0	0	0	0	0	0	0	0	0	0	0	0
Ped-Bike Adj(A_pbT)	0.99		0.99	1.00		1.00	1.00		0.98	1.00		0.98
Parking Bus, Adj	1.00	1.00	1.00	1.00	1.00	1.00	1.00	1.00	1.00	1.00	1.00	1.00
Work Zone On Approach		No			No			No			No	
Adj Sat Flow, veh/h/ln	1885	1885	1885	1900	1900	1900	1885	1885	1885	1885	1885	1885
Adj Flow Rate, veh/h	62	190	11	275	108	31	24	438	322	99	757	29
Peak Hour Factor	0.91	0.91	0.91	0.91	0.91	0.91	0.91	0.91	0.91	0.91	0.91	0.91
Percent Heavy Veh, %	1	1	1	0	0	0	1	1	1	1	1	1
Cap, veh/h	338	241	14	337	296	85	286	509	374	266	1009	836
Arrive On Green	0.05	0.14	0.13	0.12	0.21	0.20	0.03	0.51	0.50	0.06	0.54	0.54
Sat Flow, veh/h	1795	1764	102	1810	1418	407	1795	998	734	1795	1885	1561
Grp Volume(v), veh/h	62	0	201	275	0	139	24	0	760	99	757	29
Grp Sat Flow(s),veh/h/ln	1795	0	1866	1810	0	1824	1795	0	1732	1795	1885	1561
Q Serve(g_s), s	2.6	0.0	9.5	11.0	0.0	5.9	0.6	0.0	34.9	2.3	28.3	0.8
Cycle Q Clear(g_c), s	2.6	0.0	9.5	11.0	0.0	5.9	0.6	0.0	34.9	2.3	28.3	0.8
Prop In Lane	1.00		0.05	1.00		0.22	1.00		0.42	1.00		1.00
Lane Grp Cap(c), veh/h	338	0	255	337	0	381	286	0	883	266	1009	836
V/C Ratio(X)	0.18	0.00	0.79	0.82	0.00	0.37	0.08	0.00	0.86	0.37	0.75	0.03
Avail Cap(c_a), veh/h	468	0	329	337	0	381	448	0	1069	383	1163	963
HCM Platoon Ratio	1.00	1.00	1.00	1.00	1.00	1.00	1.00	1.00	1.00	1.00	1.00	1.00
Upstream Filter(I)	1.00	0.00	1.00	1.00	0.00	1.00	1.00	0.00	1.00	1.00	1.00	1.00
Uniform Delay (d), s/veh	31.2	0.0	37.9	29.3	0.0	30.8	13.8	0.0	19.6	17.0	16.4	10.0
Incr Delay (d2), s/veh	0.1	0.0	7.0	13.4	0.0	0.2	0.0	0.0	7.2	0.3	2.9	0.0
Initial Q Delay(d3),s/veh	0.0	0.0	0.0	0.0	0.0	0.0	0.0	0.0	0.0	0.0	0.0	0.0
%ile BackOfQ(50%),veh/ln	1.1	0.0	4.8	6.2	0.0	2.6	0.2	0.0	14.7	0.9	12.0	0.3
Unsig. Movement Delay, s/veh												
LnGrp Delay(d),s/veh	31.3	0.0	44.9	42.7	0.0	31.0	13.8	0.0	26.8	17.4	19.3	10.0
LnGrp LOS	C	A	D	D	A	C	B	A	C	B	B	B
Approach Vol, veh/h		263			414			784			885	
Approach Delay, s/veh		41.7			38.8			26.4			18.8	
Approach LOS		D			D			C			B	
Timer - Assigned Phs	1	2	3	4	5	6	7	8				
Phs Duration (G+Y+Rc), s	9.1	50.3	15.0	16.4	6.8	52.6	8.5	22.9				
Change Period (Y+Rc), s	4.5	5.0	4.5	4.5	4.5	5.0	4.5	4.5				
Max Green Setting (Gmax), s	10.5	55.0	10.5	15.5	10.5	55.0	10.5	15.5				
Max Q Clear Time (g_c+I1), s	4.3	36.9	13.0	11.5	2.6	30.3	4.6	7.9				
Green Ext Time (p_c), s	0.1	8.4	0.0	0.2	0.0	9.8	0.0	0.2				

Intersection Summary

HCM 6th Ctrl Delay	27.4
HCM 6th LOS	C

Notes

User approved pedestrian interval to be less than phase max green.

HCM 6th Signalized Intersection Summary

2: SW Boones Ferry Rd & SW Avery St

06/30/2021



Movement	EBL	EBT	EBR	WBL	WBT	WBR	NBL	NBT	NBR	SBL	SBT	SBR
Lane Configurations												
Traffic Volume (veh/h)	257	131	287	53	45	9	126	472	44	14	830	106
Future Volume (veh/h)	257	131	287	53	45	9	126	472	44	14	830	106
Initial Q (Qb), veh	0	0	0	0	0	0	0	0	0	0	0	0
Ped-Bike Adj(A_pbT)	0.99		0.97	1.00		0.99	1.00		0.98	1.00		0.98
Parking Bus, Adj	1.00	1.00	1.00	1.00	1.00	1.00	1.00	1.00	1.00	1.00	1.00	1.00
Work Zone On Approach		No		No		No		No		No		No
Adj Sat Flow, veh/h/ln	1841	1841	1841	1870	1870	1870	1811	1811	1811	1870	1870	1870
Adj Flow Rate, veh/h	268	136	226	55	47	4	131	492	41	15	865	100
Peak Hour Factor	0.96	0.96	0.96	0.96	0.96	0.96	0.96	0.96	0.96	0.96	0.96	0.96
Percent Heavy Veh, %	4	4	4	2	2	2	6	6	6	2	2	2
Cap, veh/h	425	135	225	128	186	16	171	965	80	437	910	105
Arrive On Green	0.15	0.22	0.21	0.04	0.11	0.10	0.05	0.59	0.57	0.02	0.55	0.55
Sat Flow, veh/h	1753	608	1011	1781	1697	144	1725	1645	137	1781	1641	190
Grp Volume(v), veh/h	268	0	362	55	0	51	131	0	533	15	0	965
Grp Sat Flow(s),veh/h/ln	1753	0	1619	1781	0	1842	1725	0	1782	1781	0	1831
Q Serve(g_s), s	15.4	0.0	26.0	3.2	0.0	3.0	3.8	0.0	20.6	0.4	0.0	58.0
Cycle Q Clear(g_c), s	15.4	0.0	26.0	3.2	0.0	3.0	3.8	0.0	20.6	0.4	0.0	58.0
Prop In Lane	1.00		0.62	1.00		0.08	1.00		0.08	1.00		0.10
Lane Grp Cap(c), veh/h	425	0	361	128	0	202	171	0	1046	437	0	1015
V/C Ratio(X)	0.63	0.00	1.00	0.43	0.00	0.25	0.77	0.00	0.51	0.03	0.00	0.95
Avail Cap(c_a), veh/h	477	0	361	153	0	202	175	0	1046	499	0	1035
HCM Platoon Ratio	1.00	1.00	1.00	1.00	1.00	1.00	1.00	1.00	1.00	1.00	1.00	1.00
Upstream Filter(I)	1.00	0.00	1.00	1.00	0.00	1.00	1.00	0.00	1.00	1.00	0.00	1.00
Uniform Delay (d), s/veh	37.0	0.0	45.7	45.3	0.0	47.6	27.4	0.0	14.3	12.7	0.0	24.5
Incr Delay (d2), s/veh	1.4	0.0	48.4	0.8	0.0	0.2	15.9	0.0	0.6	0.0	0.0	17.4
Initial Q Delay(d3),s/veh	0.0	0.0	0.0	0.0	0.0	0.0	0.0	0.0	0.0	0.0	0.0	0.0
%ile BackOfQ(50%),veh/ln	6.7	0.0	15.2	1.4	0.0	1.4	2.7	0.0	8.2	0.2	0.0	28.5
Unsig. Movement Delay, s/veh												
LnGrp Delay(d),s/veh	38.4	0.0	94.1	46.2	0.0	47.9	43.3	0.0	14.8	12.8	0.0	41.9
LnGrp LOS	D	A	F	D	A	D	D	A	B	B	A	D
Approach Vol, veh/h		630			106			664			980	
Approach Delay, s/veh		70.4			47.0			20.5			41.5	
Approach LOS		E			D			C			D	
Timer - Assigned Phs	1	2	3	4	5	6	7	8				
Phs Duration (G+Y+Rc), s	5.9	72.5	8.3	30.0	9.7	68.7	21.5	16.8				
Change Period (Y+Rc), s	4.0	5.5	4.0	5.0	4.0	5.5	4.0	5.0				
Max Green Setting (Gmax), s	6.0	64.5	6.0	25.0	6.0	64.5	21.0	10.0				
Max Q Clear Time (g_c+1), s	12.4	22.6	5.2	28.0	5.8	60.0	17.4	5.0				
Green Ext Time (p_c), s	0.0	6.0	0.0	0.0	0.0	3.2	0.1	0.0				

Intersection Summary

HCM 6th Ctrl Delay	43.5
HCM 6th LOS	D

Notes

User approved pedestrian interval to be less than phase max green.

HCM 6th Signalized Intersection Summary

3: SW Boones Ferry Road & SW Ibach Street/SW Ibach Court

06/30/2021



Movement	EBL	EBT	EBR	WBL	WBT	WBR	NBL	NBT	NBR	SBL	SBT	SBR
Lane Configurations												
Traffic Volume (veh/h)	165	0	172	3	1	6	205	474	2	12	872	290
Future Volume (veh/h)	165	0	172	3	1	6	205	474	2	12	872	290
Initial Q (Qb), veh	0	0	0	0	0	0	0	0	0	0	0	0
Ped-Bike Adj(A_pbT)	0.95		0.98	0.98		0.95	1.00		0.99	1.00		0.99
Parking Bus, Adj	1.00	1.00	1.00	1.00	1.00	1.00	1.00	1.00	1.00	1.00	1.00	1.00
Work Zone On Approach		No			No			No			No	
Adj Sat Flow, veh/h/ln	1885	1885	1885	1900	1900	1900	1841	1841	1841	1870	1870	1870
Adj Flow Rate, veh/h	172	0	75	3	1	6	214	494	2	12	908	245
Peak Hour Factor	0.96	0.96	0.96	0.96	0.96	0.96	0.96	0.96	0.96	0.96	0.96	0.96
Percent Heavy Veh, %	1	1	1	0	0	0	4	4	4	2	2	2
Cap, veh/h	303	0	252	104	49	149	221	1230	5	21	1042	876
Arrive On Green	0.16	0.00	0.16	0.16	0.16	0.16	0.13	0.67	0.67	0.01	0.56	0.56
Sat Flow, veh/h	1347	0	1558	310	305	922	1753	1832	7	1781	1870	1574
Grp Volume(v), veh/h	172	0	75	10	0	0	214	0	496	12	908	245
Grp Sat Flow(s),veh/h/ln	1347	0	1558	1537	0	0	1753	0	1839	1781	1870	1574
Q Serve(g_s), s	10.1	0.0	3.7	0.0	0.0	0.0	10.6	0.0	10.6	0.6	36.4	7.1
Cycle Q Clear(g_c), s	10.6	0.0	3.7	0.4	0.0	0.0	10.6	0.0	10.6	0.6	36.4	7.1
Prop In Lane	1.00		1.00	0.30		0.60	1.00		0.00	1.00		1.00
Lane Grp Cap(c), veh/h	303	0	252	303	0	0	221	0	1235	21	1042	876
V/C Ratio(X)	0.57	0.00	0.30	0.03	0.00	0.00	0.97	0.00	0.40	0.58	0.87	0.28
Avail Cap(c_a), veh/h	479	0	456	497	0	0	221	0	1235	225	1181	994
HCM Platoon Ratio	1.00	1.00	1.00	1.00	1.00	1.00	1.00	1.00	1.00	1.00	1.00	1.00
Upstream Filter(I)	1.00	0.00	1.00	1.00	0.00	0.00	1.00	0.00	1.00	1.00	1.00	1.00
Uniform Delay (d), s/veh	35.0	0.0	32.1	30.8	0.0	0.0	37.9	0.0	6.4	42.8	16.6	10.1
Incr Delay (d2), s/veh	1.0	0.0	0.4	0.0	0.0	0.0	50.7	0.0	0.3	14.9	7.3	0.3
Initial Q Delay(d3),s/veh	0.0	0.0	0.0	0.0	0.0	0.0	0.0	0.0	0.0	0.0	0.0	0.0
%ile BackOfQ(50%),veh/ln	3.5	0.0	1.4	0.2	0.0	0.0	7.5	0.0	3.4	0.3	15.6	2.3
Unsig. Movement Delay, s/veh												
LnGrp Delay(d),s/veh	36.0	0.0	32.5	30.8	0.0	0.0	88.6	0.0	6.8	57.7	23.9	10.4
LnGrp LOS	D	A	C	C	A	A	F	A	A	E	C	B
Approach Vol, veh/h		247			10			710			1165	
Approach Delay, s/veh		34.9			30.8			31.4			21.4	
Approach LOS		C			C			C			C	
Timer - Assigned Phs	1	2		4	5	6		8				
Phs Duration (G+Y+Rc), s	5.0	63.5		18.6	15.0	53.5		18.6				
Change Period (Y+Rc), s	4.0	5.0		4.5	4.0	5.0		4.5				
Max Green Setting (Gmax), s	1.0	55.0		25.5	11.0	55.0		25.5				
Max Q Clear Time (g_c+1/2g), s	12.6	12.6		12.6	12.6	38.4		2.4				
Green Ext Time (p_c), s	0.0	5.7		0.5	0.0	10.1		0.0				

Intersection Summary

HCM 6th Ctrl Delay	26.4
HCM 6th LOS	C

HCM 6th TWSC
4: SW Boones Ferry Road & SW Iowa Drive

06/30/2021

Intersection												
Int Delay, s/veh	7.4											
Movement	EBL	EBT	EBR	WBL	WBT	WBR	NBL	NBT	NBR	SBL	SBT	SBR
Lane Configurations		↕			↕		↕	↕		↕	↕	
Traffic Vol, veh/h	37	0	35	13	1	39	34	581	30	36	879	51
Future Vol, veh/h	37	0	35	13	1	39	34	581	30	36	879	51
Conflicting Peds, #/hr	0	0	4	4	0	0	4	0	4	0	0	0
Sign Control	Stop	Stop	Stop	Stop	Stop	Stop	Free	Free	Free	Free	Free	Free
RT Channelized	-	-	None	-	-	None	-	-	None	-	-	None
Storage Length	-	-	-	-	-	-	95	-	-	105	-	-
Veh in Median Storage, #	-	0	-	-	0	-	-	0	-	-	0	-
Grade, %	-	0	-	-	0	-	-	0	-	-	0	-
Peak Hour Factor	94	94	94	94	94	94	94	94	94	94	94	94
Heavy Vehicles, %	5	5	5	2	2	2	3	3	3	1	1	1
Mvmt Flow	39	0	37	14	1	41	36	618	32	38	935	54

Major/Minor	Minor2		Minor1		Major1			Major2				
Conflicting Flow All	1769	1768	970	1771	1779	638	993	0	0	654	0	0
Stage 1	1042	1042	-	710	710	-	-	-	-	-	-	-
Stage 2	727	726	-	1061	1069	-	-	-	-	-	-	-
Critical Hdwy	7.15	6.55	6.25	7.12	6.52	6.22	4.13	-	-	4.11	-	-
Critical Hdwy Stg 1	6.15	5.55	-	6.12	5.52	-	-	-	-	-	-	-
Critical Hdwy Stg 2	6.15	5.55	-	6.12	5.52	-	-	-	-	-	-	-
Follow-up Hdwy	3.545	4.045	3.345	3.518	4.018	3.318	2.227	-	-	2.209	-	-
Pot Cap-1 Maneuver	64	82	303	65	82	477	693	-	-	938	-	-
Stage 1	274	303	-	424	437	-	-	-	-	-	-	-
Stage 2	411	425	-	271	298	-	-	-	-	-	-	-
Platoon blocked, %								-	-	-	-	-
Mov Cap-1 Maneuver	54	74	301	53	74	475	690	-	-	934	-	-
Mov Cap-2 Maneuver	54	74	-	53	74	-	-	-	-	-	-	-
Stage 1	259	289	-	400	413	-	-	-	-	-	-	-
Stage 2	355	401	-	227	285	-	-	-	-	-	-	-

Approach	EB		WB		NB		SB	
HCM Control Delay, s	139.7		40.9		0.6		0.3	
HCM LOS	F		E					

Minor Lane/Major Mvmt	NBL	NBT	NBR	EBLn1WBLn1	SBL	SBT	SBR
Capacity (veh/h)	690	-	-	90	155	934	-
HCM Lane V/C Ratio	0.052	-	-	0.851	0.364	0.041	-
HCM Control Delay (s)	10.5	-	-	139.7	40.9	9	-
HCM Lane LOS	B	-	-	F	E	A	-
HCM 95th %tile Q(veh)	0.2	-	-	4.6	1.5	0.1	-

HCM 6th TWSC
 5: SW Boones Ferry Road & SW Norwood Road

06/30/2021

Intersection						
Int Delay, s/veh	3.1					
Movement	WBL	WBR	NBT	NBR	SBL	SBT
Lane Configurations	Y		↑	↑	↑	↑
Traffic Vol, veh/h	55	100	545	120	130	797
Future Vol, veh/h	55	100	545	120	130	797
Conflicting Peds, #/hr	2	2	0	2	2	0
Sign Control	Stop	Stop	Free	Free	Free	Free
RT Channelized	-	None	-	None	-	None
Storage Length	-	-	-	65	290	-
Veh in Median Storage, #	0	-	0	-	-	0
Grade, %	0	-	0	-	-	0
Peak Hour Factor	95	95	95	95	95	95
Heavy Vehicles, %	2	2	3	3	2	2
Mvmt Flow	58	105	574	126	137	839

Major/Minor	Minor1	Major1	Major2		
Conflicting Flow All	1691	578	0	0	702
Stage 1	576	-	-	-	-
Stage 2	1115	-	-	-	-
Critical Hdwy	6.42	6.22	-	-	4.12
Critical Hdwy Stg 1	5.42	-	-	-	-
Critical Hdwy Stg 2	5.42	-	-	-	-
Follow-up Hdwy	3.518	3.318	-	-	2.218
Pot Cap-1 Maneuver	103	516	-	-	895
Stage 1	562	-	-	-	-
Stage 2	314	-	-	-	-
Platoon blocked, %			-	-	-
Mov Cap-1 Maneuver	87	514	-	-	893
Mov Cap-2 Maneuver	198	-	-	-	-
Stage 1	561	-	-	-	-
Stage 2	265	-	-	-	-

Approach	WB	NB	SB
HCM Control Delay, s	26.4	0	1.4
HCM LOS	D		

Minor Lane/Major Mvmt	NBT	NBRWBLn1	SBL	SBT
Capacity (veh/h)	-	-	328	893
HCM Lane V/C Ratio	-	-	0.497	0.153
HCM Control Delay (s)	-	-	26.4	9.8
HCM Lane LOS	-	-	D	A
HCM 95th %tile Q(veh)	-	-	2.6	0.5

Intersection												
Int Delay, s/veh	1.7											
Movement	EBL	EBT	EBR	WBL	WBT	WBR	NBL	NBT	NBR	SBL	SBT	SBR
Lane Configurations		↕↔			↕	↕	↕	↕	↕	↕	↕	↕
Traffic Vol, veh/h	1	0	1	69	0	34	2	626	115	51	812	0
Future Vol, veh/h	1	0	1	69	0	34	2	626	115	51	812	0
Conflicting Peds, #/hr	0	0	0	2	0	2	0	0	2	2	0	0
Sign Control	Stop	Stop	Stop	Stop	Stop	Stop	Free	Free	Free	Free	Free	Free
RT Channelized	-	-	None	-	-	None	-	-	None	-	-	None
Storage Length	-	-	-	-	-	150	150	-	100	150	-	-
Veh in Median Storage, #	-	0	-	-	2	-	-	0	-	-	0	-
Grade, %	-	0	-	-	0	-	-	0	-	-	0	-
Peak Hour Factor	92	92	92	95	92	95	92	95	95	95	95	92
Heavy Vehicles, %	2	2	2	0	2	0	2	3	3	2	2	2
Mvmt Flow	1	0	1	73	0	36	2	659	121	54	855	0

Major/Minor	Minor2		Minor1		Major1		Major2					
Conflicting Flow All	1707	1749	857	1631	1628	663	855	0	0	782	0	0
Stage 1	963	963	-	665	665	-	-	-	-	-	-	-
Stage 2	744	786	-	966	963	-	-	-	-	-	-	-
Critical Hdwy	7.12	6.52	6.22	7.1	6.52	6.2	4.12	-	-	4.12	-	-
Critical Hdwy Stg 1	6.12	5.52	-	6.1	5.52	-	-	-	-	-	-	-
Critical Hdwy Stg 2	6.12	5.52	-	6.1	5.52	-	-	-	-	-	-	-
Follow-up Hdwy	3.518	4.018	3.318	3.5	4.018	3.3	2.218	-	-	2.218	-	-
Pot Cap-1 Maneuver	72	86	357	82	102	465	785	-	-	836	-	-
Stage 1	307	334	-	453	458	-	-	-	-	-	-	-
Stage 2	407	403	-	309	334	-	-	-	-	-	-	-
Platoon blocked, %								-	-	-	-	-
Mov Cap-1 Maneuver	63	80	356	77	95	463	785	-	-	834	-	-
Mov Cap-2 Maneuver	63	80	-	238	257	-	-	-	-	-	-	-
Stage 1	306	312	-	451	456	-	-	-	-	-	-	-
Stage 2	374	401	-	288	312	-	-	-	-	-	-	-

Approach	EB		WB		NB		SB		
HCM Control Delay, s	39.3		22.2		0		0.6		
HCM LOS	E		C						

Minor Lane/Major Mvmt	NBL	NBT	NBR	EBLn1	WBLn1	WBLn2	SBL	SBT	SBR
Capacity (veh/h)	785	-	-	107	238	463	834	-	-
HCM Lane V/C Ratio	0.003	-	-	0.02	0.305	0.077	0.064	-	-
HCM Control Delay (s)	9.6	-	-	39.3	26.6	13.4	9.6	-	-
HCM Lane LOS	A	-	-	E	D	B	A	-	-
HCM 95th %tile Q(veh)	0	-	-	0.1	1.2	0.2	0.2	-	-

HCM 6th Signalized Intersection Summary

7: SW Boones Ferry Road & Basalt Creek Parkway Extension

06/30/2021



Movement	EBL	EBR	NBL	NBT	SBT	SBR
Lane Configurations						
Traffic Volume (veh/h)	39	243	199	701	801	78
Future Volume (veh/h)	39	243	199	701	801	78
Initial Q (Qb), veh	0	0	0	0	0	0
Ped-Bike Adj(A_pbT)	1.00	1.00	1.00			1.00
Parking Bus, Adj	1.00	1.00	1.00	1.00	1.00	1.00
Work Zone On Approach	No			No	No	
Adj Sat Flow, veh/h/ln	1900	1900	1856	1856	1870	1870
Adj Flow Rate, veh/h	41	256	209	738	843	82
Peak Hour Factor	0.95	0.95	0.95	0.95	0.95	0.95
Percent Heavy Veh, %	0	0	3	3	2	2
Cap, veh/h	267	454	238	1407	974	95
Arrive On Green	0.15	0.15	0.27	1.00	0.58	0.58
Sat Flow, veh/h	1810	1610	1767	1856	1677	163
Grp Volume(v), veh/h	41	256	209	738	0	925
Grp Sat Flow(s),veh/h/ln	1810	1610	1767	1856	0	1841
Q Serve(g_s), s	2.1	14.2	11.9	0.0	0.0	44.5
Cycle Q Clear(g_c), s	2.1	14.2	11.9	0.0	0.0	44.5
Prop In Lane	1.00	1.00	1.00			0.09
Lane Grp Cap(c), veh/h	267	454	238	1407	0	1069
V/C Ratio(X)	0.15	0.56	0.88	0.52	0.00	0.87
Avail Cap(c_a), veh/h	267	454	429	1407	0	1069
HCM Platoon Ratio	1.00	1.00	2.00	2.00	1.00	1.00
Upstream Filter(I)	1.00	1.00	0.83	0.83	0.00	1.00
Uniform Delay (d), s/veh	39.0	32.2	37.5	0.0	0.0	18.6
Incr Delay (d2), s/veh	0.2	1.4	5.4	1.2	0.0	9.4
Initial Q Delay(d3),s/veh	0.0	0.0	0.0	0.0	0.0	0.0
%ile BackOfQ(50%),veh/ln	0.9	13.0	4.7	0.5	0.0	20.2
Unsig. Movement Delay, s/veh						
LnGrp Delay(d),s/veh	39.2	33.5	43.0	1.2	0.0	28.0
LnGrp LOS	D	C	D	A	A	C
Approach Vol, veh/h	297			947	925	
Approach Delay, s/veh	34.3			10.4	28.0	
Approach LOS	C			B	C	
Timer - Assigned Phs		2		4	5	6
Phs Duration (G+Y+Rc), s		85.0		20.0	18.6	66.4
Change Period (Y+Rc), s		* 5.4		4.5	4.5	* 5.4
Max Green Setting (Gmax), s		* 80		15.5	25.5	* 50
Max Q Clear Time (g_c+I1), s		2.0		16.2	13.9	46.5
Green Ext Time (p_c), s		12.0		0.0	0.3	2.3

Intersection Summary

HCM 6th Ctrl Delay	21.2
HCM 6th LOS	C

Notes

User approved pedestrian interval to be less than phase max green.

* HCM 6th computational engine requires equal clearance times for the phases crossing the barrier.

HCM 6th Signalized Intersection Summary

8: SW Boones Ferry Road & SW Day Road

06/30/2021



Movement	EBL	EBT	EBR	WBL	WBT	WBR	NBL	NBT	NBR	SBL	SBT	SBR
Lane Configurations		↕	↗		↕		↗	↖		↖	↕	↗
Traffic Volume (veh/h)	6	0	568	0	0	0	465	894	0	0	1026	17
Future Volume (veh/h)	6	0	568	0	0	0	465	894	0	0	1026	17
Initial Q (Qb), veh	0	0	0	0	0	0	0	0	0	0	0	0
Ped-Bike Adj(A_pbT)	1.00		1.00	1.00		1.00	1.00		1.00	1.00		1.00
Parking Bus, Adj	1.00	1.00	1.00	1.00	1.00	1.00	1.00	1.00	1.00	1.00	1.00	1.00
Work Zone On Approach		No			No			No			No	
Adj Sat Flow, veh/h/ln	1870	1870	1870	1900	1900	1900	1856	1856	1856	1885	1885	1885
Adj Flow Rate, veh/h	6	0	529	0	0	0	474	912	0	0	1047	14
Peak Hour Factor	0.98	0.98	0.98	0.98	0.98	0.98	0.98	0.98	0.98	0.98	0.98	0.98
Percent Heavy Veh, %	2	2	2	0	0	0	3	3	3	1	1	1
Cap, veh/h	271	0	551	0	271	0	555	914	0	417	1979	26
Arrive On Green	0.14	0.00	0.15	0.00	0.00	0.00	0.39	0.99	0.00	0.00	0.37	0.36
Sat Flow, veh/h	1418	0	1585	0	1900	0	2827	1856	0	1795	3619	48
Grp Volume(v), veh/h	6	0	529	0	0	0	474	912	0	0	518	543
Grp Sat Flow(s),veh/h/ln	1418	0	1585	0	1900	0	1414	1856	0	1795	1791	1876
Q Serve(g_s), s	0.4	0.0	15.9	0.0	0.0	0.0	16.1	44.7	0.0	0.0	23.9	23.9
Cycle Q Clear(g_c), s	0.4	0.0	15.9	0.0	0.0	0.0	16.1	44.7	0.0	0.0	23.9	23.9
Prop In Lane	1.00		1.00	0.00		0.00	1.00		0.00	1.00		0.03
Lane Grp Cap(c), veh/h	264	0	551	0	271	0	555	914	0	417	979	1026
V/C Ratio(X)	0.02	0.00	0.96	0.00	0.00	0.00	0.85	1.00	0.00	0.00	0.53	0.53
Avail Cap(c_a), veh/h	264	0	551	0	271	0	1158	1219	0	417	979	1026
HCM Platoon Ratio	1.00	1.00	1.00	1.00	1.00	1.00	2.00	2.00	2.00	0.67	0.67	0.67
Upstream Filter(I)	1.00	0.00	1.00	0.00	0.00	0.00	0.89	0.89	0.00	0.00	0.61	0.61
Uniform Delay (d), s/veh	39.0	0.0	33.5	0.0	0.0	0.0	30.5	0.7	0.0	0.0	22.6	22.7
Incr Delay (d2), s/veh	0.0	0.0	28.4	0.0	0.0	0.0	2.2	27.5	0.0	0.0	1.3	1.2
Initial Q Delay(d3),s/veh	0.0	0.0	0.0	0.0	0.0	0.0	0.0	0.0	0.0	0.0	0.0	0.0
%ile BackOfQ(50%),veh/ln	0.1	0.0	16.8	0.0	0.0	0.0	4.3	7.3	0.0	0.0	10.7	11.2
Unsig. Movement Delay, s/veh												
LnGrp Delay(d),s/veh	39.0	0.0	62.0	0.0	0.0	0.0	32.7	28.3	0.0	0.0	23.9	23.9
LnGrp LOS	D	A	E	A	A	A	C	C	A	A	C	C
Approach Vol, veh/h		535			0			1386			1061	
Approach Delay, s/veh		61.7			0.0			29.8			23.9	
Approach LOS		E						C			C	
Timer - Assigned Phs	1	2		4	5	6		8				
Phs Duration (G+Y+Rc), s	24.6	61.4		19.0	26.7	59.3		19.0				
Change Period (Y+Rc), s	5.4	* 5.4		4.5	* 5.4	* 5.4		4.5				
Max Green Setting (Gmax), s	42	* 34		14.5	* 8.5	* 68		14.5				
Max Q Clear Time (g_c+11g), s	11.9	25.9		0.0	0.0	46.7		17.9				
Green Ext Time (p_c), s	1.1	5.0		0.0	0.0	10.7		0.0				

Intersection Summary

HCM 6th Ctrl Delay	33.4
HCM 6th LOS	C

Notes

User approved pedestrian interval to be less than phase max green.

* HCM 6th computational engine requires equal clearance times for the phases crossing the barrier.

HCM 6th Signalized Intersection Summary

9: SW Boones Ferry Road & SW 95th Avenue

06/30/2021



Movement	EBL	EBT	EBR	WBL	WBT	WBR	NBL	NBT	NBR	SBL	SBT	SBR
Lane Configurations		↕	↗	↖	↗	↖	↗	↖		↖	↗	↖
Traffic Volume (veh/h)	241	1	834	50	18	7	605	1015	12	3	1237	245
Future Volume (veh/h)	241	1	834	50	18	7	605	1015	12	3	1237	245
Initial Q (Qb), veh	0	0	0	0	0	0	0	0	0	0	0	0
Ped-Bike Adj(A_pbT)	0.99		0.97	1.00		0.99	1.00		1.00	1.00		1.00
Parking Bus, Adj	1.00	1.00	1.00	1.00	1.00	1.00	1.00	1.00	1.00	1.00	1.00	1.00
Work Zone On Approach		No		No		No		No		No		No
Adj Sat Flow, veh/h/ln	1826	1826	1826	1870	1870	1870	1781	1781	1781	1856	1856	1856
Adj Flow Rate, veh/h	251	1	869	52	19	7	630	1057	12	3	1289	0
Peak Hour Factor	0.96	0.96	0.96	0.96	0.96	0.96	0.96	0.96	0.96	0.96	0.96	0.96
Percent Heavy Veh, %	5	5	5	2	2	2	8	8	8	3	3	3
Cap, veh/h	281	1	1053	75	223	82	727	1318	15	583	1740	
Arrive On Green	0.16	0.17	0.17	0.17	0.17	0.17	0.44	0.77	0.75	0.66	0.99	0.00
Sat Flow, veh/h	1239	5	2634	636	1302	480	3291	3428	39	1767	3526	1572
Grp Volume(v), veh/h	252	0	869	52	0	26	630	522	547	3	1289	0
Grp Sat Flow(s),veh/h/ln	1244	0	1317	636	0	1781	1646	1692	1774	1767	1763	1572
Q Serve(g_s), s	15.7	0.0	18.0	1.0	0.0	1.3	18.2	19.5	19.5	0.1	1.9	0.0
Cycle Q Clear(g_c), s	17.0	0.0	18.0	18.0	0.0	1.3	18.2	19.5	19.5	0.1	1.9	0.0
Prop In Lane	1.00		1.00	1.00		0.27	1.00		0.02	1.00		1.00
Lane Grp Cap(c), veh/h	270	0	1053	75	0	305	727	651	682	583	1740	
V/C Ratio(X)	0.93	0.00	0.83	0.70	0.00	0.09	0.87	0.80	0.80	0.01	0.74	
Avail Cap(c_a), veh/h	270	0	1053	75	0	305	1066	1048	1098	583	1740	
HCM Platoon Ratio	1.00	1.00	1.00	1.00	1.00	1.00	2.00	2.00	2.00	2.00	2.00	2.00
Upstream Filter(I)	1.00	0.00	1.00	1.00	0.00	1.00	0.55	0.55	0.55	0.69	0.69	0.00
Uniform Delay (d), s/veh	45.8	0.0	28.9	52.4	0.0	36.6	27.9	9.7	9.7	12.0	0.4	0.0
Incr Delay (d2), s/veh	37.2	0.0	5.3	23.2	0.0	0.1	3.0	5.8	5.5	0.0	2.0	0.0
Initial Q Delay(d3),s/veh	0.0	0.0	0.0	0.0	0.0	0.0	0.0	0.0	0.0	0.0	0.0	0.0
%ile BackOfQ(50%),veh/ln	0.5	0.0	10.3	1.8	0.0	0.6	5.4	4.3	4.5	0.0	0.7	0.0
Unsig. Movement Delay, s/veh												
LnGrp Delay(d),s/veh	83.0	0.0	34.2	75.7	0.0	36.7	30.9	15.5	15.2	12.0	2.4	0.0
LnGrp LOS	F	A	C	E	A	D	C	B	B	B	A	
Approach Vol, veh/h		1121			78			1699			1292	A
Approach Delay, s/veh		45.2			62.7			21.1			2.4	
Approach LOS		D			E			C			A	
Timer - Assigned Phs	1	2		4	5	6		8				
Phs Duration (G+Y+Rc), s	27.2	55.8		22.0	38.6	44.4		22.0				
Change Period (Y+Rc), s	5.0	5.0		5.0	5.0	5.0		5.0				
Max Green Setting (Gmax), s	33.0	40.0		17.0	9.0	64.0		17.0				
Max Q Clear Time (g_c+20.2), s	20.2	3.9		20.0	2.1	21.5		20.0				
Green Ext Time (p_c), s	2.0	12.2		0.0	0.0	17.9		0.0				

Intersection Summary

HCM 6th Ctrl Delay	22.6
HCM 6th LOS	C

Notes

User approved pedestrian interval to be less than phase max green.

Unsignalized Delay for [SBR] is excluded from calculations of the approach delay and intersection delay.

HCM Signalized Intersection Capacity Analysis
 10: I-5 SB Ramps & SW Boones Ferry Road/SW Elligsen Road

06/23/2021



Movement	EBL	EBT	EBR	WBL	WBT	WBR	NBL	NBT	NBR	SBL	SBT	SBR
Lane Configurations		↑↑	↗		↑↑	↗				↘	↖	↗
Traffic Volume (vph)	0	1167	953	0	759	389	0	0	0	597	91	872
Future Volume (vph)	0	1167	953	0	759	389	0	0	0	597	91	872
Ideal Flow (vphpl)	1900	1900	1900	1900	1900	1900	1900	1900	1900	1900	1900	1900
Lane Width	12	12	12	12	12	12	12	12	12	12	12	16
Total Lost time (s)		4.0	4.0		4.0	3.0				4.0	4.0	4.0
Lane Util. Factor		0.95	1.00		0.95	1.00				0.95	0.95	1.00
Fr _t		1.00	0.85		1.00	0.85				1.00	1.00	0.85
Fl _t Protected		1.00	1.00		1.00	1.00				0.95	0.96	1.00
Satd. Flow (prot)		3505	1568		3505	1568				1603	1627	1711
Fl _t Permitted		1.00	1.00		1.00	1.00				0.95	0.96	1.00
Satd. Flow (perm)		3505	1568		3505	1568				1603	1627	1711
Peak-hour factor, PHF	0.97	0.97	0.97	0.97	0.97	0.97	0.97	0.97	0.97	0.97	0.97	0.97
Adj. Flow (vph)	0	1203	982	0	782	401	0	0	0	615	94	899
RTOR Reduction (vph)	0	0	0	0	0	0	0	0	0	0	0	42
Lane Group Flow (vph)	0	1203	982	0	782	401	0	0	0	351	358	857
Heavy Vehicles (%)	3%	3%	3%	3%	3%	3%	0%	0%	0%	7%	7%	7%
Turn Type		NA	Free		NA	Free				Split	NA	custom
Protected Phases		2			6					4	4	5
Permitted Phases			Free		6	Free						4
Actuated Green, G (s)		67.8	105.0		38.3	105.0				27.7	27.7	52.7
Effective Green, g (s)		68.8	105.0		39.3	105.0				28.2	28.2	53.7
Actuated g/C Ratio		0.66	1.00		0.37	1.00				0.27	0.27	0.51
Clearance Time (s)		5.0			5.0					4.5	4.5	4.5
Vehicle Extension (s)		4.1			4.1					2.3	2.3	2.3
Lane Grp Cap (vph)		2296	1568		1311	1568				430	436	940
v/s Ratio Prot		0.34			0.22					0.22	0.22	c0.22
v/s Ratio Perm			c0.63			0.26						0.28
v/c Ratio		0.52	0.63		0.60	0.26				0.82	0.82	0.91
Uniform Delay, d ₁		9.5	0.0		26.5	0.0				36.0	36.0	23.5
Progression Factor		0.93	1.00		0.97	1.00				1.00	1.00	1.00
Incremental Delay, d ₂		0.6	1.2		1.9	0.4				11.0	11.4	12.7
Delay (s)		9.4	1.2		27.5	0.4				47.0	47.5	36.2
Level of Service		A	A		C	A				D	D	D
Approach Delay (s)		5.7			18.3			0.0			41.1	
Approach LOS		A			B			A			D	
Intersection Summary												
HCM 2000 Control Delay			20.1									C
HCM 2000 Volume to Capacity ratio			0.86									
Actuated Cycle Length (s)			105.0							12.0		
Intersection Capacity Utilization			81.6%									D
Analysis Period (min)			15									

c Critical Lane Group

V/C Ratio calculated using HCM worksheet with correct critical movements and lost time

HCM 6th Signalized Intersection Summary
 11: I-5 NB Ramps & SW Elligsen Road

06/30/2021

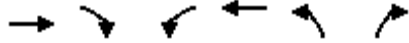

Movement	EBT	EBR	WBL	WBT	NBL	NBR
Lane Configurations	↑↑	↗		↑↑	↖↗	↗
Traffic Volume (veh/h)	1026	741	0	798	352	245
Future Volume (veh/h)	1026	741	0	798	352	245
Initial Q (Qb), veh	0	0	0	0	0	0
Ped-Bike Adj(A_pbT)		1.00	1.00		1.00	1.00
Parking Bus, Adj	1.00	1.00	1.00	1.00	1.00	1.00
Work Zone On Approach	No			No	No	
Adj Sat Flow, veh/h/ln	1841	1841	0	1885	1841	1841
Adj Flow Rate, veh/h	1127	0	0	877	387	0
Peak Hour Factor	0.91	0.91	0.91	0.91	0.91	0.91
Percent Heavy Veh, %	4	4	0	1	4	4
Cap, veh/h	2733		0	2799	484	
Arrive On Green	1.00	0.00	0.00	0.78	0.14	0.00
Sat Flow, veh/h	3589	1560	0	3770	3401	1560
Grp Volume(v), veh/h	1127	0	0	877	387	0
Grp Sat Flow(s),veh/h/ln	1749	1560	0	1791	1700	1560
Q Serve(g_s), s	0.0	0.0	0.0	7.4	11.6	0.0
Cycle Q Clear(g_c), s	0.0	0.0	0.0	7.4	11.6	0.0
Prop In Lane		1.00	0.00		1.00	1.00
Lane Grp Cap(c), veh/h	2733		0	2799	484	
V/C Ratio(X)	0.41		0.00	0.31	0.80	
Avail Cap(c_a), veh/h	2733		0	2799	1166	
HCM Platoon Ratio	2.00	2.00	1.00	1.00	1.00	1.00
Upstream Filter(l)	0.78	0.00	0.00	1.00	1.00	0.00
Uniform Delay (d), s/veh	0.0	0.0	0.0	3.3	43.6	0.0
Incr Delay (d2), s/veh	0.4	0.0	0.0	0.3	1.9	0.0
Initial Q Delay(d3),s/veh	0.0	0.0	0.0	0.0	0.0	0.0
%ile BackOfQ(50%),veh/ln	0.1	0.0	0.0	2.0	5.0	0.0
Unsig. Movement Delay, s/veh						
LnGrp Delay(d),s/veh	0.4	0.0	0.0	3.6	45.5	0.0
LnGrp LOS	A		A	A	D	
Approach Vol, veh/h	1127	A		877	387	A
Approach Delay, s/veh	0.4			3.6	45.5	
Approach LOS	A			A	D	
Timer - Assigned Phs		2			6	8
Phs Duration (G+Y+Rc), s		86.0			86.0	19.0
Change Period (Y+Rc), s		5.0			5.0	4.5
Max Green Setting (Gmax), s		60.0			60.0	35.5
Max Q Clear Time (g_c+I1), s		2.0			9.4	13.6
Green Ext Time (p_c), s		17.2			11.4	0.9

Intersection Summary

HCM 6th Ctrl Delay	8.9
HCM 6th LOS	A

Notes

Unsignalized Delay for [NBR, EBR] is excluded from calculations of the approach delay and intersection delay.

HCM 6th TWSC
 12: Site Access/SW 89th Avenue & SW Norwood Road

06/30/2021

Intersection												
Int Delay, s/veh	1.4											
Movement	EBL	EBT	EBR	WBL	WBT	WBR	NBL	NBT	NBR	SBL	SBT	SBR
Lane Configurations		↕			↕			↕			↕	
Traffic Vol, veh/h	33	236	20	5	168	14	12	0	3	11	0	9
Future Vol, veh/h	33	236	20	5	168	14	12	0	3	11	0	9
Conflicting Peds, #/hr	2	0	0	0	0	2	0	0	0	2	0	2
Sign Control	Free	Free	Free	Free	Free	Free	Stop	Stop	Stop	Stop	Stop	Stop
RT Channelized	-	-	None	-	-	None	-	-	None	-	-	None
Storage Length	-	-	-	-	-	-	-	-	-	-	-	-
Veh in Median Storage, #	-	0	-	-	0	-	-	0	-	-	0	-
Grade, %	-	0	-	-	0	-	-	0	-	-	0	-
Peak Hour Factor	92	92	92	92	92	92	92	92	92	92	92	92
Heavy Vehicles, %	1	1	2	2	0	0	2	2	2	0	2	0
Mvmt Flow	36	257	22	5	183	15	13	0	3	12	0	10

Major/Minor	Major1			Major2			Minor1			Minor2		
Conflicting Flow All	200	0	0	279	0	0	548	550	270	547	554	195
Stage 1	-	-	-	-	-	-	340	340	-	203	203	-
Stage 2	-	-	-	-	-	-	208	210	-	344	351	-
Critical Hdwy	4.11	-	-	4.12	-	-	7.12	6.52	6.22	7.1	6.52	6.2
Critical Hdwy Stg 1	-	-	-	-	-	-	6.12	5.52	-	6.1	5.52	-
Critical Hdwy Stg 2	-	-	-	-	-	-	6.12	5.52	-	6.1	5.52	-
Follow-up Hdwy	2.209	-	-	2.218	-	-	3.518	4.018	3.318	3.5	4.018	3.3
Pot Cap-1 Maneuver	1378	-	-	1284	-	-	447	443	769	451	440	851
Stage 1	-	-	-	-	-	-	675	639	-	804	733	-
Stage 2	-	-	-	-	-	-	794	728	-	676	632	-
Platoon blocked, %	-	-	-	-	-	-	-	-	-	-	-	-
Mov Cap-1 Maneuver	1375	-	-	1284	-	-	429	427	768	436	424	848
Mov Cap-2 Maneuver	-	-	-	-	-	-	429	427	-	436	424	-
Stage 1	-	-	-	-	-	-	654	619	-	777	729	-
Stage 2	-	-	-	-	-	-	780	724	-	651	612	-

Approach	EB			WB			NB			SB		
HCM Control Delay, s	0.9			0.2			12.9			11.7		
HCM LOS							B			B		

Minor Lane/Major Mvmt	NBLn1	EBL	EBT	EBR	WBL	WBT	WBR	SBLn1
Capacity (veh/h)	471	1375	-	-	1284	-	-	558
HCM Lane V/C Ratio	0.035	0.026	-	-	0.004	-	-	0.039
HCM Control Delay (s)	12.9	7.7	0	-	7.8	0	-	11.7
HCM Lane LOS	B	A	A	-	A	A	-	B
HCM 95th %tile Q(veh)	0.1	0.1	-	-	0	-	-	0.1

Intersection												
Int Delay, s/veh	3.7											
Movement	EBL	EBT	EBR	WBL	WBT	WBR	NBL	NBT	NBR	SBL	SBT	SBR
Lane Configurations		↕			↕			↕			↕	
Traffic Vol, veh/h	70	144	36	25	132	39	18	0	17	24	0	37
Future Vol, veh/h	70	144	36	25	132	39	18	0	17	24	0	37
Conflicting Peds, #/hr	0	0	0	0	0	0	0	0	0	0	0	0
Sign Control	Free	Free	Free	Free	Free	Free	Stop	Stop	Stop	Stop	Stop	Stop
RT Channelized	-	-	None	-	-	None	-	-	None	-	-	None
Storage Length	-	-	-	-	-	-	-	-	-	-	-	-
Veh in Median Storage, #	-	0	-	-	0	-	-	0	-	-	0	-
Grade, %	-	0	-	-	0	-	-	0	-	-	0	-
Peak Hour Factor	80	80	80	80	80	80	80	80	80	80	80	80
Heavy Vehicles, %	1	1	2	2	0	0	2	2	2	0	2	0
Mvmt Flow	88	180	45	31	165	49	23	0	21	30	0	46

Major/Minor	Major1			Major2			Minor1			Minor2		
Conflicting Flow All	214	0	0	225	0	0	654	655	203	641	653	190
Stage 1	-	-	-	-	-	-	379	379	-	252	252	-
Stage 2	-	-	-	-	-	-	275	276	-	389	401	-
Critical Hdwy	4.11	-	-	4.12	-	-	7.12	6.52	6.22	7.1	6.52	6.2
Critical Hdwy Stg 1	-	-	-	-	-	-	6.12	5.52	-	6.1	5.52	-
Critical Hdwy Stg 2	-	-	-	-	-	-	6.12	5.52	-	6.1	5.52	-
Follow-up Hdwy	2.209	-	-	2.218	-	-	3.518	4.018	3.318	3.5	4.018	3.3
Pot Cap-1 Maneuver	1362	-	-	1344	-	-	380	386	838	390	387	857
Stage 1	-	-	-	-	-	-	643	615	-	757	698	-
Stage 2	-	-	-	-	-	-	731	682	-	639	601	-
Platoon blocked, %	-	-	-	-	-	-	-	-	-	-	-	-
Mov Cap-1 Maneuver	1362	-	-	1344	-	-	333	348	838	351	349	857
Mov Cap-2 Maneuver	-	-	-	-	-	-	333	348	-	351	349	-
Stage 1	-	-	-	-	-	-	595	569	-	701	680	-
Stage 2	-	-	-	-	-	-	674	664	-	577	557	-

Approach	EB			WB			NB			SB		
HCM Control Delay, s	2.2			1			13.4			12.6		
HCM LOS							B			B		

Minor Lane/Major Mvmt	NBLn1	EBL	EBT	EBR	WBL	WBT	WBR	SBLn1
Capacity (veh/h)	471	1362	-	-	1344	-	-	547
HCM Lane V/C Ratio	0.093	0.064	-	-	0.023	-	-	0.139
HCM Control Delay (s)	13.4	7.8	0	-	7.7	0	-	12.6
HCM Lane LOS	B	A	A	-	A	A	-	B
HCM 95th %tile Q(veh)	0.3	0.2	-	-	0.1	-	-	0.5

HCM 6th TWSC
 14: SW 82nd Avenue & SW Norwood Road/Driveway

06/30/2021

Intersection												
Int Delay, s/veh	7.1											
Movement	EBL	EBT	EBR	WBL	WBT	WBR	NBL	NBT	NBR	SBL	SBT	SBR
Lane Configurations		↕			↕			↕			↕	↗
Traffic Vol, veh/h	150	0	35	0	0	1	21	8	0	2	4	175
Future Vol, veh/h	150	0	35	0	0	1	21	8	0	2	4	175
Conflicting Peds, #/hr	0	0	0	0	0	0	0	0	0	0	0	0
Sign Control	Free	Free	Free	Free	Free	Free	Stop	Stop	Stop	Stop	Stop	Stop
RT Channelized	-	-	None	-	-	None	-	-	None	-	-	Free
Storage Length	-	-	-	-	-	-	-	-	-	-	-	15
Veh in Median Storage, #	-	0	-	-	0	-	-	0	-	-	0	-
Grade, %	-	0	-	-	0	-	-	0	-	-	0	-
Peak Hour Factor	83	83	83	83	83	83	83	83	83	83	83	83
Heavy Vehicles, %	0	0	0	0	0	0	0	0	0	0	0	0
Mvmt Flow	181	0	42	0	0	1	25	10	0	2	5	211

Major/Minor	Major1			Major2			Minor1			Minor2		
Conflicting Flow All	1	0	0	42	0	0	386	384	21	389	405	-
Stage 1	-	-	-	-	-	-	383	383	-	1	1	-
Stage 2	-	-	-	-	-	-	3	1	-	388	404	-
Critical Hdwy	4.1	-	-	4.1	-	-	7.1	6.5	6.2	7.1	6.5	-
Critical Hdwy Stg 1	-	-	-	-	-	-	6.1	5.5	-	6.1	5.5	-
Critical Hdwy Stg 2	-	-	-	-	-	-	6.1	5.5	-	6.1	5.5	-
Follow-up Hdwy	2.2	-	-	2.2	-	-	3.5	4	3.3	3.5	4	-
Pot Cap-1 Maneuver	1635	-	-	1580	-	-	576	553	1062	574	538	0
Stage 1	-	-	-	-	-	-	644	616	-	1027	899	0
Stage 2	-	-	-	-	-	-	1025	899	-	640	603	0
Platoon blocked, %	-	-	-	-	-	-	-	-	-	-	-	-
Mov Cap-1 Maneuver	1635	-	-	1580	-	-	522	490	1062	516	477	-
Mov Cap-2 Maneuver	-	-	-	-	-	-	522	490	-	516	477	-
Stage 1	-	-	-	-	-	-	571	546	-	910	899	-
Stage 2	-	-	-	-	-	-	1020	899	-	557	534	-

Approach	EB			WB			NB			SB		
HCM Control Delay, s	6.1			0			12.5			12.5		
HCM LOS							B			B		

Minor Lane/Major Mvmt	NBLn1	EBL	EBT	EBR	WBL	WBT	WBR	SBLn1	SBLn2
Capacity (veh/h)	513	1635	-	-	1580	-	-	489	-
HCM Lane V/C Ratio	0.068	0.111	-	-	-	-	-	0.015	-
HCM Control Delay (s)	12.5	7.5	0	-	0	-	-	12.5	0
HCM Lane LOS	B	A	A	-	A	-	-	B	A
HCM 95th %tile Q(veh)	0.2	0.4	-	-	0	-	-	0	-

HCM 6th TWSC
 15: SW 65th Avenue & SW Norwood Road

06/30/2021

Intersection						
Int Delay, s/veh	4.4					
Movement	EBL	EBR	NBL	NBT	SBT	SBR
Lane Configurations	T			T		
Traffic Vol, veh/h	82	72	65	227	403	139
Future Vol, veh/h	82	72	65	227	403	139
Conflicting Peds, #/hr	0	0	0	0	0	0
Sign Control	Stop	Stop	Free	Free	Free	Free
RT Channelized	-	None	-	None	-	None
Storage Length	-	-	-	-	-	-
Veh in Median Storage, #	0	-	-	0	0	-
Grade, %	0	-	-	0	0	-
Peak Hour Factor	89	89	89	89	89	89
Heavy Vehicles, %	0	0	2	2	0	0
Mvmt Flow	92	81	73	255	453	156

Major/Minor	Minor2	Major1	Major2			
Conflicting Flow All	932	531	609	0	-	0
Stage 1	531	-	-	-	-	-
Stage 2	401	-	-	-	-	-
Critical Hdwy	6.4	6.2	4.12	-	-	-
Critical Hdwy Stg 1	5.4	-	-	-	-	-
Critical Hdwy Stg 2	5.4	-	-	-	-	-
Follow-up Hdwy	3.5	3.3	2.218	-	-	-
Pot Cap-1 Maneuver	298	552	970	-	-	-
Stage 1	594	-	-	-	-	-
Stage 2	681	-	-	-	-	-
Platoon blocked, %				-	-	-
Mov Cap-1 Maneuver	272	552	970	-	-	-
Mov Cap-2 Maneuver	272	-	-	-	-	-
Stage 1	542	-	-	-	-	-
Stage 2	681	-	-	-	-	-

Approach	EB	NB	SB
HCM Control Delay, s	24.2	2	0
HCM LOS	C		

Minor Lane/Major Mvmt	NBL	NBT	EBLn1	SBT	SBR
Capacity (veh/h)	970	-	357	-	-
HCM Lane V/C Ratio	0.075	-	0.485	-	-
HCM Control Delay (s)	9	0	24.2	-	-
HCM Lane LOS	A	A	C	-	-
HCM 95th %tile Q(veh)	0.2	-	2.5	-	-

HCM Signalized Intersection Capacity Analysis

10: I-5 SB Ramps & SW Elligsen Road

08/31/2021















Movement	EBL	EBT	EBR	WBL	WBT	WBR	NBL	NBT	NBR	SBL	SBT	SBR
Lane Configurations		↑↑	↗		↑↑	↗				↘	↖	↗↗
Traffic Volume (vph)	0	960	359	0	741	121	0	0	0	540	0	1015
Future Volume (vph)	0	960	359	0	741	121	0	0	0	540	0	1015
Ideal Flow (vphpl)	1900	1900	1900	1900	1900	1900	1900	1900	1900	1900	1900	1900
Lane Width	12	12	12	12	12	12	12	12	12	12	12	16
Total Lost time (s)		4.0	4.0		4.0	4.0				4.0	4.0	4.0
Lane Util. Factor		0.95	1.00		0.95	1.00				0.95	0.95	0.88
Frbp, ped/bikes		1.00	0.99		1.00	1.00				1.00	1.00	1.00
Flpb, ped/bikes		1.00	1.00		1.00	1.00				1.00	1.00	1.00
Frt		1.00	0.85		1.00	0.85				1.00	1.00	0.85
Flt Protected		1.00	1.00		1.00	1.00				0.95	0.95	1.00
Satd. Flow (prot)		3034	1340		3406	1524				1573	1573	2955
Flt Permitted		1.00	1.00		1.00	1.00				0.95	0.95	1.00
Satd. Flow (perm)		3034	1340		3406	1524				1573	1573	2955
Peak-hour factor, PHF	0.94	0.94	0.94	0.94	0.94	0.94	0.94	0.94	0.94	0.94	0.94	0.94
Adj. Flow (vph)	0	1021	382	0	788	129	0	0	0	574	0	1080
RTOR Reduction (vph)	0	0	0	0	0	0	0	0	0	0	0	56
Lane Group Flow (vph)	0	1021	382	0	788	129	0	0	0	287	287	1024
Confl. Peds. (#/hr)			2									
Heavy Vehicles (%)	19%	19%	19%	6%	6%	6%	0%	0%	0%	9%	9%	9%
Turn Type		NA	Free		NA	Free				Split	NA	custom
Protected Phases		2			6					4	4	5
Permitted Phases			Free		6	Free						4
Actuated Green, G (s)		64.1	95.0		44.4	95.0				21.4	21.4	36.6
Effective Green, g (s)		65.1	95.0		45.4	95.0				21.9	21.9	37.6
Actuated g/C Ratio		0.69	1.00		0.48	1.00				0.23	0.23	0.40
Clearance Time (s)		5.0			5.0					4.5	4.5	4.5
Vehicle Extension (s)		4.1			4.1					2.3	2.3	2.3
Lane Grp Cap (vph)		2079	1340		1627	1524				362	362	1293
v/s Ratio Prot		c0.34			0.23					0.18	0.18	c0.13
v/s Ratio Perm			0.29			0.08						0.22
v/c Ratio		0.49	0.29		0.48	0.08				0.79	0.79	0.79
Uniform Delay, d1		7.1	0.0		16.8	0.0				34.4	34.4	25.3
Progression Factor		2.04	1.00		0.50	1.00				1.00	1.00	1.00
Incremental Delay, d2		0.6	0.4		0.9	0.1				10.8	10.8	3.3
Delay (s)		15.1	0.4		9.3	0.1				45.2	45.2	28.5
Level of Service		B	A		A	A				D	D	C
Approach Delay (s)		11.1			8.0			0.0			34.3	
Approach LOS		B			A			A			C	
Intersection Summary												
HCM 2000 Control Delay			20.1									HCM 2000 Level of Service C
HCM 2000 Volume to Capacity ratio			0.68									
Actuated Cycle Length (s)			95.0							12.0		
Intersection Capacity Utilization			62.7%									ICU Level of Service B
Analysis Period (min)			15									
c Critical Lane Group												

V/C Ratio calculated using HCM worksheet with correct critical movements and lost time

HCM Signalized Intersection Capacity Analysis
 10: I-5 SB Ramps & SW Elligsen Road

08/31/2021

													
Movement	EBL	EBT	EBR	WBL	WBT	WBR	NBL	NBT	NBR	SBL	SBT	SBR	
Lane Configurations		↑↑	↗		↑↑	↗				↘	↑	↗↗	
Traffic Volume (vph)	0	1134	940	0	713	389	0	0	0	597	91	838	
Future Volume (vph)	0	1134	940	0	713	389	0	0	0	597	91	838	
Ideal Flow (vphpl)	1900	1900	1900	1900	1900	1900	1900	1900	1900	1900	1900	1900	
Lane Width	12	12	12	12	12	12	12	12	12	12	12	16	
Total Lost time (s)		4.0	4.0		4.0	3.0				4.0	4.0	4.0	
Lane Util. Factor		0.95	1.00		0.95	1.00				0.95	0.95	0.88	
Fr _t		1.00	0.85		1.00	0.85				1.00	1.00	0.85	
Fl _t Protected		1.00	1.00		1.00	1.00				0.95	0.96	1.00	
Satd. Flow (prot)		3505	1568		3505	1568				1603	1627	3011	
Fl _t Permitted		1.00	1.00		1.00	1.00				0.95	0.96	1.00	
Satd. Flow (perm)		3505	1568		3505	1568				1603	1627	3011	
Peak-hour factor, PHF	0.97	0.97	0.97	0.97	0.97	0.97	0.97	0.97	0.97	0.97	0.97	0.97	
Adj. Flow (vph)	0	1169	969	0	735	401	0	0	0	615	94	864	
RTOR Reduction (vph)	0	0	0	0	0	0	0	0	0	0	0	78	
Lane Group Flow (vph)	0	1169	969	0	735	401	0	0	0	351	358	786	
Heavy Vehicles (%)	3%	3%	3%	3%	3%	3%	0%	0%	0%	7%	7%	7%	
Turn Type		NA	Free		NA	Free				Split	NA	custom	
Protected Phases		2			6					4	4	5	
Permitted Phases			Free		6	Free						4	
Actuated Green, G (s)		67.3	105.0		56.2	105.0				28.2	28.2	34.8	
Effective Green, g (s)		68.3	105.0		57.2	105.0				28.7	28.7	35.8	
Actuated g/C Ratio		0.65	1.00		0.54	1.00				0.27	0.27	0.34	
Clearance Time (s)		5.0			5.0					4.5	4.5	4.5	
Vehicle Extension (s)		4.1			4.1					2.3	2.3	2.3	
Lane Grp Cap (vph)		2279	1568		1909	1568				438	444	1141	
v/s Ratio Prot		0.33			0.21					0.22	c0.22	0.05	
v/s Ratio Perm			c0.62			0.26						0.21	
v/c Ratio		0.51	0.62		0.39	0.26				0.80	0.81	0.69	
Uniform Delay, d ₁		9.6	0.0		13.8	0.0				35.5	35.6	29.8	
Progression Factor		0.92	1.00		0.88	1.00				1.00	1.00	1.00	
Incremental Delay, d ₂		0.5	1.2		0.6	0.4				9.7	9.9	1.5	
Delay (s)		9.4	1.2		12.7	0.4				45.2	45.4	31.3	
Level of Service		A	A		B	A				D	D	C	
Approach Delay (s)		5.7			8.4			0.0			37.6		
Approach LOS		A			A			A			D		
Intersection Summary													
HCM 2000 Control Delay			16.7									HCM 2000 Level of Service	B
HCM 2000 Volume to Capacity ratio			0.73										
Actuated Cycle Length (s)			105.0									Sum of lost time (s)	12.0
Intersection Capacity Utilization			56.9%									ICU Level of Service	B
Analysis Period (min)			15										

c Critical Lane Group

V/C Ratio calculated using HCM worksheet with correct critical movements and lost time

HCM Signalized Intersection Capacity Analysis

10: I-5 SB Ramps & SW Elligsen Road

08/31/2021



Movement	EBL	EBT	EBR	WBL	WBT	WBR	NBL	NBT	NBR	SBL	SBT	SBR
Lane Configurations		↑↑	↗		↑↑	↗				↘	↖	↗↗
Traffic Volume (vph)	0	1011	379	0	755	121	0	0	0	540	0	1025
Future Volume (vph)	0	1011	379	0	755	121	0	0	0	540	0	1025
Ideal Flow (vphpl)	1900	1900	1900	1900	1900	1900	1900	1900	1900	1900	1900	1900
Lane Width	12	12	12	12	12	12	12	12	12	12	12	16
Total Lost time (s)		4.0	4.0		4.0	4.0				4.0	4.0	4.0
Lane Util. Factor		0.95	1.00		0.95	1.00				0.95	0.95	0.88
Frbp, ped/bikes		1.00	0.99		1.00	1.00				1.00	1.00	1.00
Flpb, ped/bikes		1.00	1.00		1.00	1.00				1.00	1.00	1.00
Frt		1.00	0.85		1.00	0.85				1.00	1.00	0.85
Flt Protected		1.00	1.00		1.00	1.00				0.95	0.95	1.00
Satd. Flow (prot)		3034	1340		3406	1524				1573	1573	2955
Flt Permitted		1.00	1.00		1.00	1.00				0.95	0.95	1.00
Satd. Flow (perm)		3034	1340		3406	1524				1573	1573	2955
Peak-hour factor, PHF	0.94	0.94	0.94	0.94	0.94	0.94	0.94	0.94	0.94	0.94	0.94	0.94
Adj. Flow (vph)	0	1076	403	0	803	129	0	0	0	574	0	1090
RTOR Reduction (vph)	0	0	0	0	0	0	0	0	0	0	0	52
Lane Group Flow (vph)	0	1076	403	0	803	129	0	0	0	287	287	1038
Confl. Peds. (#/hr)			2									
Heavy Vehicles (%)	19%	19%	19%	6%	6%	6%	0%	0%	0%	9%	9%	9%
Turn Type		NA	Free		NA	Free				Split	NA	custom
Protected Phases		2			6					4	4	5
Permitted Phases			Free		6	Free						4
Actuated Green, G (s)		64.1	95.0		43.9	95.0				21.4	21.4	37.1
Effective Green, g (s)		65.1	95.0		44.9	95.0				21.9	21.9	38.1
Actuated g/C Ratio		0.69	1.00		0.47	1.00				0.23	0.23	0.40
Clearance Time (s)		5.0			5.0					4.5	4.5	4.5
Vehicle Extension (s)		4.1			4.1					2.3	2.3	2.3
Lane Grp Cap (vph)		2079	1340		1609	1524				362	362	1309
v/s Ratio Prot		c0.35			0.24					0.18	0.18	c0.14
v/s Ratio Perm			0.30			0.08						0.22
v/c Ratio		0.52	0.30		0.50	0.08				0.79	0.79	0.79
Uniform Delay, d1		7.3	0.0		17.3	0.0				34.4	34.4	25.0
Progression Factor		2.11	1.00		0.52	1.00				1.00	1.00	1.00
Incremental Delay, d2		0.7	0.4		1.0	0.1				10.8	10.8	3.2
Delay (s)		16.1	0.4		9.9	0.1				45.2	45.2	28.2
Level of Service		B	A		A	A				D	D	C
Approach Delay (s)		11.8			8.5			0.0			34.1	
Approach LOS		B			A			A			C	
Intersection Summary												
HCM 2000 Control Delay			20.2									HCM 2000 Level of Service C
HCM 2000 Volume to Capacity ratio			0.70									
Actuated Cycle Length (s)			95.0							12.0		
Intersection Capacity Utilization			63.4%									ICU Level of Service B
Analysis Period (min)			15									
c Critical Lane Group												

V/C Ratio calculated using HCM worksheet with correct critical movements and lost time

HCM Signalized Intersection Capacity Analysis

10: I-5 SB Ramps & SW Elligsen Road

09/09/2021



Movement	EBL	EBT	EBR	WBL	WBT	WBR	NBL	NBT	NBR	SBL	SBT	SBR
Lane Configurations		↑↑	↗		↑↑	↗				↘	↖	↖↖
Traffic Volume (vph)	0	1167	953	0	759	389	0	0	0	597	91	872
Future Volume (vph)	0	1167	953	0	759	389	0	0	0	597	91	872
Ideal Flow (vphpl)	1900	1900	1900	1900	1900	1900	1900	1900	1900	1900	1900	1900
Lane Width	12	12	12	12	12	12	12	12	12	12	12	16
Total Lost time (s)		4.0	4.0		4.0	3.0				4.0	4.0	4.0
Lane Util. Factor		0.95	1.00		0.95	1.00				0.95	0.95	0.88
Fr _t		1.00	0.85		1.00	0.85				1.00	1.00	0.85
Fl _t Protected		1.00	1.00		1.00	1.00				0.95	0.96	1.00
Satd. Flow (prot)		3505	1568		3505	1568				1603	1627	3011
Fl _t Permitted		1.00	1.00		1.00	1.00				0.95	0.96	1.00
Satd. Flow (perm)		3505	1568		3505	1568				1603	1627	3011
Peak-hour factor, PHF	0.97	0.97	0.97	0.97	0.97	0.97	0.97	0.97	0.97	0.97	0.97	0.97
Adj. Flow (vph)	0	1203	982	0	782	401	0	0	0	615	94	899
RTOR Reduction (vph)	0	0	0	0	0	0	0	0	0	0	0	64
Lane Group Flow (vph)	0	1203	982	0	782	401	0	0	0	351	358	835
Heavy Vehicles (%)	3%	3%	3%	3%	3%	3%	0%	0%	0%	7%	7%	7%
Turn Type		NA	Free		NA	Free				Split	NA	custom
Protected Phases		2			6					4	4	5
Permitted Phases			Free		6	Free						4
Actuated Green, G (s)		67.3	105.0		55.9	105.0				28.2	28.2	35.1
Effective Green, g (s)		68.3	105.0		56.9	105.0				28.7	28.7	36.1
Actuated g/C Ratio		0.65	1.00		0.54	1.00				0.27	0.27	0.34
Clearance Time (s)		5.0			5.0					4.5	4.5	4.5
Vehicle Extension (s)		4.1			4.1					2.3	2.3	2.3
Lane Grp Cap (vph)		2279	1568		1899	1568				438	444	1149
v/s Ratio Prot		0.34			0.22					0.22	c0.22	c0.05
v/s Ratio Perm			c0.63			0.26						0.23
v/c Ratio		0.53	0.63		0.41	0.26				0.80	0.81	0.73
Uniform Delay, d ₁		9.8	0.0		14.2	0.0				35.5	35.6	30.1
Progression Factor		0.90	1.00		0.90	1.00				1.00	1.00	1.00
Incremental Delay, d ₂		0.6	1.2		0.6	0.4				9.7	9.9	2.1
Delay (s)		9.4	1.2		13.4	0.4				45.2	45.4	32.2
Level of Service		A	A		B	A				D	D	C
Approach Delay (s)		5.7			9.0			0.0			38.0	
Approach LOS		A			A			A			D	

Intersection Summary		
HCM 2000 Control Delay	16.9	HCM 2000 Level of Service
HCM 2000 Volume to Capacity ratio	0.74	B
Actuated Cycle Length (s)	105.0	Sum of lost time (s)
Intersection Capacity Utilization	58.2%	12.0
Analysis Period (min)	15	ICU Level of Service
		B

c Critical Lane Group

V/C Ratio calculated using HCM worksheet with correct critical movements and lost time

Signalized Intersection V/C Calculation Summary

MORNING PEAK HOUR

Intersection 1: SW Sagert Street at SW Boones Ferry Road

2021 Existing	Protected/Permitted Left-Turn Phasing				Protected/Permitted Left-Turn Phasing							
Critical Movement:	EBL	EBTR	WBL	WBTR	NBL	NBTR	SBL	SBT	SBR	Sum of Critical Flow Ratios:	Critical Intersection V/C:	0.83
Adjusted Flow Rate:	73	87	182	143	8	880	53	278	32	Cycle Length (seconds):	85.4	
Saturated Flow:	1795	1857	1810	1805	1795	1772	1725	1811	1501	Lost Time per phase (seconds):	4	
Flow Ratio:	0.04	0.05	0.10	0.08	0.00	0.50	0.03	0.15	0.02	Number of Phases	4	
	0.15				0.53							
2024 Background	Protected/Permitted Left-Turn Phasing				Protected/Permitted Left-Turn Phasing							
Critical Movement:	EBL	EBTR	WBL	WBTR	NBL	NBTR	SBL	SBT	SBR	Sum of Critical Flow Ratios:	0.72	Critical Intersection V/C: 0.87
Adjusted Flow Rate:	77	93	193	153	8	942	56	295	30	Cycle Length (seconds):	91.2	
Saturated Flow:	1795	1855	1810	1804	1795	1771	1725	1811	1501	Lost Time per phase (seconds):	4	
Flow Ratio:	0.04	0.05	0.11	0.08	0.00	0.53	0.03	0.16	0.02	Number of Phases	4	
	0.16				0.56							
2026 Background	Protected/Permitted Left-Turn Phasing				Protected/Permitted Left-Turn Phasing							
Critical Movement:	EBL	EBTR	WBL	WBTR	NBL	NBTR	SBL	SBT	SBR	Sum of Critical Flow Ratios:	0.75	Critical Intersection V/C: 0.90
Adjusted Flow Rate:	80	96	202	159	9	978	58	308	31	Cycle Length (seconds):	93.9	
Saturated Flow:	1795	1856	1810	1802	1795	1771	1725	1811	1501	Lost Time per phase (seconds):	4	
Flow Ratio:	0.04	0.05	0.11	0.09	0.01	0.55	0.03	0.17	0.02	Number of Phases	4	
	0.16				0.59							
2024 Buildout	Protected/Permitted Left-Turn Phasing				Protected/Permitted Left-Turn Phasing							
Critical Movement:	EBL	EBTR	WBL	WBTR	NBL	NBTR	SBL	SBT	SBR	Sum of Critical Flow Ratios:	0.73	Critical Intersection V/C: 0.88
Adjusted Flow Rate:	77	93	197	153	8	952	56	298	30	Cycle Length (seconds):	92.4	
Saturated Flow:	1795	1855	1810	1804	1795	1770	1725	1811	1501	Lost Time per phase (seconds):	4	
Flow Ratio:	0.04	0.05	0.11	0.08	0.00	0.54	0.03	0.16	0.02	Number of Phases	4	
	0.16				0.57							
2026 Buildout	Protected/Permitted Left-Turn Phasing				Protected/Permitted Left-Turn Phasing							
Critical Movement:	EBL	EBTR	WBL	WBTR	NBL	NBTR	SBL	SBT	SBR	Sum of Critical Flow Ratios:	0.78	Critical Intersection V/C: 0.94
Adjusted Flow Rate:	80	96	210	159	9	1024	58	315	31	Cycle Length (seconds):	95.1	
Saturated Flow:	1795	1856	1810	1802	1795	1768	1725	1811	1501	Lost Time per phase (seconds):	4	
Flow Ratio:	0.04	0.05	0.12	0.09	0.01	0.58	0.03	0.17	0.02	Number of Phases	4	
	0.17				0.61							
2026 Buildout w/ BCE	Protected/Permitted Left-Turn Phasing				Protected/Permitted Left-Turn Phasing							
Critical Movement:	EBL	EBTR	WBL	WBTR	NBL	NBTR	SBL	SBT	SBR	Sum of Critical Flow Ratios:	0.78	Critical Intersection V/C: 0.94
Adjusted Flow Rate:	80	96	210	159	9	1024	58	315	31	Cycle Length (seconds):	95.1	
Saturated Flow:	1795	1856	1810	1802	1795	1768	1725	1811	1501	Lost Time per phase (seconds):	4	
Flow Ratio:	0.04	0.05	0.12	0.09	0.01	0.58	0.03	0.17	0.02	Number of Phases	4	
	0.17				0.61							

Notes:

Since EB and WB left-turn phases are protected, critical ring is either EBL+WBTR or WBL+EBT - HCM6 does not show reductions for permitted left turns
 Since NB and SB left-turn phases are protected, critical ring is either NBL+SBT or SBL+NBT - HCM6 does not show reductions for permitted left turns

Signalized Intersection V/C Calculation Summary

MORNING PEAK HOUR

Intersection 2: SW Avery Road at SW Boones Ferry Road

2021 Existing	Protected/Permitted Left-Turn Phasing				Protected/Permitted Left-Turn Phasing							
Critical Movement:	EBL	EBTR	WBL	WBTR	NBL	NBTR	SBL	SBTR	Sum of Critical Flow Ratios:	0.65	Critical Intersection V/C:	0.82
Adjusted Flow Rate:	193	163	33	126	281	808	7	487	Cycle Length (seconds):	77		
Saturated Flow:	1753	1650	1753	1805	1682	1749	1753	1739	Lost Time per phase (seconds):	4		
Flow Ratio:	0.11	0.10	0.02	0.07	0.17	0.46	0.00	0.28	Number of Phases	4		
	0.18				0.47							
2024 Background	Protected/Permitted Left-Turn Phasing				Protected/Permitted Left-Turn Phasing							
Critical Movement:	EBL	EBTR	WBL	WBTR	NBL	NBTR	SBL	SBTR	Sum of Critical Flow Ratios:	0.69	Critical Intersection V/C:	0.84
Adjusted Flow Rate:	205	178	36	135	298	857	7	517	Cycle Length (seconds):	86.5		
Saturated Flow:	1753	1646	1753	1804	1682	1749	1753	1740	Lost Time per phase (seconds):	4		
Flow Ratio:	0.12	0.11	0.02	0.07	0.18	0.49	0.00	0.30	Number of Phases	4		
	0.19				0.49							
2026 Background	Protected/Permitted Left-Turn Phasing				Protected/Permitted Left-Turn Phasing							
Critical Movement:	EBL	EBTR	WBL	WBTR	NBL	NBTR	SBL	SBTR	Sum of Critical Flow Ratios:	0.72	Critical Intersection V/C:	0.87
Adjusted Flow Rate:	212	181	37	139	313	900	8	541	Cycle Length (seconds):	93.5		
Saturated Flow:	1753	1648	1753	1805	1682	1749	1753	1739	Lost Time per phase (seconds):	4		
Flow Ratio:	0.12	0.11	0.02	0.08	0.19	0.51	0.00	0.31	Number of Phases	4		
	0.20				0.52							
2024 Buildout	Protected/Permitted Left-Turn Phasing				Protected/Permitted Left-Turn Phasing							
Critical Movement:	EBL	EBTR	WBL	WBTR	NBL	NBTR	SBL	SBTR	Sum of Critical Flow Ratios:	0.70	Critical Intersection V/C:	0.85
Adjusted Flow Rate:	205	181	36	135	307	878	7	525	Cycle Length (seconds):	89.3		
Saturated Flow:	1753	1643	1753	1804	1682	1749	1753	1741	Lost Time per phase (seconds):	4		
Flow Ratio:	0.12	0.11	0.02	0.07	0.18	0.50	0.00	0.30	Number of Phases	4		
	0.19				0.51							
2026 Buildout	Protected/Permitted Left-Turn Phasing				Protected/Permitted Left-Turn Phasing							
Critical Movement:	EBL	EBTR	WBL	WBTR	NBL	NBTR	SBL	SBTR	Sum of Critical Flow Ratios:	0.75	Critical Intersection V/C:	0.89
Adjusted Flow Rate:	212	189	37	139	337	950	8	558	Cycle Length (seconds):	99.6		
Saturated Flow:	1753	1642	1753	1805	1682	1750	1753	1742	Lost Time per phase (seconds):	4		
Flow Ratio:	0.12	0.12	0.02	0.08	0.20	0.54	0.00	0.32	Number of Phases	4		
	0.20				0.55							
2026 Buildout w/ BCE	Protected/Permitted Left-Turn Phasing				Protected/Permitted Left-Turn Phasing							
Critical Movement:	EBL	EBTR	WBL	WBTR	NBL	NBTR	SBL	SBTR	Sum of Critical Flow Ratios:	0.75	Critical Intersection V/C:	0.89
Adjusted Flow Rate:	212	185	37	139	325	950	8	558	Cycle Length (seconds):	100.1		
Saturated Flow:	1753	1645	1753	1805	1682	1750	1753	1742	Lost Time per phase (seconds):	4		
Flow Ratio:	0.12	0.11	0.02	0.08	0.19	0.54	0.00	0.32	Number of Phases	4		
	0.20				0.55							

Notes:

Since EB and WB left-turn phases are protected, critical ring is either EBL+WBTR or WBL+EBTR - HCM6 does not show reductions for permitted left turns
 Since NB and SB left-turn phases are protected, critical ring is either NBL+SBTR or SBL+NBTR - HCM6 does not show reductions for permitted left turns

Signalized Intersection V/C Calculation Summary

MORNING PEAK HOUR

Intersection 3: SW Ibach Street at SW Boones Ferry Road

2021 Existing	Permitted Left-Turn Phasing			Protected/Permitted Left-Turn Phasing							
Critical Movement:	EBL	EBTR	WBLTR	NBL	NBTR	SBL	SBT	SBR	Sum of Critical Flow Ratios:		Critical Intersection V/C:
Adjusted Flow Rate:	274	203	20	140	774	3	411	51	Cycle Length (seconds):	66.1	
Saturated Flow:	1353	1564	1376	1711	1792	1725	1811	1526	Lost Time per phase (seconds):	4	
Flow Ratio:	0.20	0.13	0.01	0.08	0.43	0.00	0.23	0.03	Number of Phases	3	
	0.20			0.43							
2024 Background	Permitted Left-Turn Phasing			Protected/Permitted Left-Turn Phasing							
Critical Movement:	EBL	EBTR	WBLTR	NBL	NBTR	SBL	SBT	SBR	Sum of Critical Flow Ratios:	0.67	Critical Intersection V/C:
Adjusted Flow Rate:	290	213	16	148	821	3	436	51	Cycle Length (seconds):	74.3	
Saturated Flow:	1359	1564	1186	1711	1792	1725	1811	1526	Lost Time per phase (seconds):	4	
Flow Ratio:	0.21	0.14	0.01	0.09	0.46	0.00	0.24	0.03	Number of Phases	3	
	0.21			0.46							
2026 Background	Permitted Left-Turn Phasing			Protected/Permitted Left-Turn Phasing							
Critical Movement:	EBL	EBTR	WBLTR	NBL	NBTR	SBL	SBT	SBR	Sum of Critical Flow Ratios:	0.70	Critical Intersection V/C:
Adjusted Flow Rate:	301	227	11	154	865	3	457	54	Cycle Length (seconds):	80.3	
Saturated Flow:	1367	1564	953	1711	1792	1725	1811	1526	Lost Time per phase (seconds):	4	
Flow Ratio:	0.22	0.15	0.01	0.09	0.48	0.00	0.25	0.04	Number of Phases	3	
	0.22			0.48							
2024 Buildout	Permitted Left-Turn Phasing			Protected/Permitted Left-Turn Phasing							
Critical Movement:	EBL	EBTR	WBLTR	NBL	NBTR	SBL	SBT	SBR	Sum of Critical Flow Ratios:	0.69	Critical Intersection V/C:
Adjusted Flow Rate:	290	215	16	153	852	3	446	51	Cycle Length (seconds):	91.1	
Saturated Flow:	1360	1564	1164	1711	1792	1725	1811	1526	Lost Time per phase (seconds):	4	
Flow Ratio:	0.21	0.14	0.01	0.09	0.48	0.00	0.25	0.03	Number of Phases	3	
	0.21			0.48							
2026 Buildout	Permitted Left-Turn Phasing			Protected/Permitted Left-Turn Phasing							
Critical Movement:	EBL	EBTR	WBLTR	NBL	NBTR	SBL	SBT	SBR	Sum of Critical Flow Ratios:	0.75	Critical Intersection V/C:
Adjusted Flow Rate:	301	231	11	166	941	3	483	54	Cycle Length (seconds):	88.7	
Saturated Flow:	1371	1564	917	1711	1792	1725	1811	1527	Lost Time per phase (seconds):	4	
Flow Ratio:	0.22	0.15	0.01	0.10	0.53	0.00	0.27	0.04	Number of Phases	3	
	0.22			0.53							
2026 Buildout w/ BCE	Permitted Left-Turn Phasing			Protected/Permitted Left-Turn Phasing							
Critical Movement:	EBL	EBTR	WBLTR	NBL	NBTR	SBL	SBT	SBR	Sum of Critical Flow Ratios:	0.74	Critical Intersection V/C:
Adjusted Flow Rate:	301	230	11	161	929	3	478	54	Cycle Length (seconds):	87.5	
Saturated Flow:	1370	1564	923	1711	1792	1725	1811	1527	Lost Time per phase (seconds):	4	
Flow Ratio:	0.22	0.15	0.01	0.09	0.52	0.00	0.26	0.04	Number of Phases	3	
	0.22			0.52							

Notes:

Since EB and WB left-turn phases are permitted, critical ring is maximum of any lane group.

Since NB and SB left-turn phases are protected, critical ring is either EBL+WBTR or WBL+EBT - HCM6 does not show reductions for permitted left turns

Signalized Intersection V/C Calculation Summary

MORNING PEAK HOUR

Intersection 8: SW Day Road at SW Boones Ferry Road

2021 Existing	Permitted Left-Turn Phasing (w/ Right-Turn Overlap)			Protected Left-Turn Phasing							
Critical Movement:	EBLT	EBR	WBLTR	NBL	NBTR	SBL	SBTR	Sum of Critical Flow Ratios:	0.54	Critical Intersection V/C:	0.62
Adjusted Flow Rate:	180	537	0	649	497	0	563	Cycle Length (seconds):	95		
Saturated Flow:	1283	1434	1900	2740	1693	1711	3452	Lost Time per phase (seconds):	4		
Flow Ratio:	0.14	0.37	0.00	0.24	0.29	0.00	0.16	Number of Phases	3		
	0.14			0.40							
2024 Background	Permitted Left-Turn Phasing (w/ Right-Turn Overlap)			Protected Left-Turn Phasing							
Critical Movement:	EBLT	EBR	WBLTR	NBL	NBTR	SBL	SBTR	Sum of Critical Flow Ratios:	0.57	Critical Intersection V/C:	0.65
Adjusted Flow Rate:	191	572	0	688	527	0	593	Cycle Length (seconds):	95		
Saturated Flow:	1283	1434	1900	2740	1693	1711	3456	Lost Time per phase (seconds):	4		
Flow Ratio:	0.15	0.40	0.00	0.25	0.31	0.00	0.17	Number of Phases	3		
	0.15			0.42							
2026 Background	Permitted Left-Turn Phasing (w/ Right-Turn Overlap)			Protected Left-Turn Phasing							
Critical Movement:	EBLT	EBR	WBLTR	NBL	NBTR	SBL	SBTR	Sum of Critical Flow Ratios:	0.60	Critical Intersection V/C:	0.65
Adjusted Flow Rate:	199	596	0	713	551	0	631	Cycle Length (seconds):	95		
Saturated Flow:	1283	1434	1900	2740	1693	1711	3453	Lost Time per phase (seconds):	4		
Flow Ratio:	0.16	0.42	0.00	0.26	0.33	0.00	0.18	Number of Phases	2		
	0.42			0.18							
2024 Buildout	Permitted Left-Turn Phasing (w/ Right-Turn Overlap)			Protected Left-Turn Phasing							
Critical Movement:	EBLT	EBR	WBLTR	NBL	NBTR	SBL	SBTR	Sum of Critical Flow Ratios:	0.59	Critical Intersection V/C:	0.67
Adjusted Flow Rate:	194	572	0	688	538	0	635	Cycle Length (seconds):	95		
Saturated Flow:	1283	1434	1900	2740	1693	1711	3449	Lost Time per phase (seconds):	4		
Flow Ratio:	0.15	0.40	0.00	0.25	0.32	0.00	0.18	Number of Phases	3		
	0.15			0.44							
2026 Buildout	Permitted Left-Turn Phasing (w/ Right-Turn Overlap)			Protected Left-Turn Phasing							
Critical Movement:	EBLT	EBR	WBLTR	NBL	NBTR	SBL	SBTR	Sum of Critical Flow Ratios:	0.63	Critical Intersection V/C:	0.73
Adjusted Flow Rate:	207	596	0	713	578	0	733	Cycle Length (seconds):	95		
Saturated Flow:	1283	1434	1900	2740	1693	1711	3441	Lost Time per phase (seconds):	4		
Flow Ratio:	0.16	0.42	0.00	0.26	0.34	0.00	0.21	Number of Phases	3		
	0.16			0.47							
2026 Buildout w/ BCE	Permitted Left-Turn Phasing (w/ Right-Turn Overlap)			Protected Left-Turn Phasing							
Critical Movement:	EBLT	EBR	WBLTR	NBL	NBTR	SBL	SBTR	Sum of Critical Flow Ratios:	0.47	Critical Intersection V/C:	0.52
Adjusted Flow Rate:	41	272	0	357	934	0	989	Cycle Length (seconds):	95		
Saturated Flow:	1283	1434	1900	2740	1693	1711	3499	Lost Time per phase (seconds):	4		
Flow Ratio:	0.03	0.19	0.00	0.13	0.55	0.00	0.28	Number of Phases	2		
	0.19			0.28							

Notes:

Since EB and WB left-turn phases are permitted, critical ring is maximum of any left or through lane group unless $EBR > EBT+NBL$ or $WBR > WBT+SBL$.

Since NB and SB left-turn phases are protected, critical ring is either $NBL+SBL$ or $NBL+SBT$ unless $EBR > EBT+NBL$ or $WBR > WBT+SBL$.

Signalized Intersection V/C Calculation Summary

MORNING PEAK HOUR

Intersection 9: SW 95th Avenue at SW Boones Ferry Road

2021 Existing

	Permitted Left-Turn Phasing (w/ Right-Turn Overlap)				Protected Left-Turn Phasing							
Critical Movement:	EBLT	EBR	WBL	WBTR	NBL	NBTR	SBL	SBT	Sum of Critical Flow Ratios:	0.65	Critical Intersection V/C:	0.74
Adjusted Flow Rate:	213	515	16	8	836	898	5	723	Cycle Length (seconds):	95		
Saturated Flow:	1219	1223	816	1496	3319	3454	1654	3300	Lost Time per phase (seconds):	4		
Flow Ratio:	0.17	0.42	0.02	0.01	0.25	0.26	0.00	0.22	Number of Phases	3		
	0.17				0.47							

2024 Background

	Permitted Left-Turn Phasing (w/ Right-Turn Overlap)				Protected Left-Turn Phasing							
Critical Movement:	EBLT	EBR	WBL	WBTR	NBL	NBTR	SBL	SBT	Sum of Critical Flow Ratios:	0.68	Critical Intersection V/C:	0.78
Adjusted Flow Rate:	225	549	17	8	886	952	5	766	Cycle Length (seconds):	95		
Saturated Flow:	1219	1223	791	1496	3319	3454	1654	3300	Lost Time per phase (seconds):	4		
Flow Ratio:	0.18	0.45	0.02	0.01	0.27	0.28	0.00	0.23	Number of Phases	3		
	0.18				0.50							

2026 Background

	Permitted Left-Turn Phasing (w/ Right-Turn Overlap)				Protected Left-Turn Phasing							
Critical Movement:	EBLT	EBR	WBL	WBTR	NBL	NBTR	SBL	SBT	Sum of Critical Flow Ratios:	0.72	Critical Intersection V/C:	0.82
Adjusted Flow Rate:	235	571	18	9	920	991	7	808	Cycle Length (seconds):	95		
Saturated Flow:	1215	2445	775	1493	3319	3455	1654	3300	Lost Time per phase (seconds):	4		
Flow Ratio:	0.19	0.23	0.02	0.01	0.28	0.29	0.00	0.24	Number of Phases	3		
	0.19				0.52							

2024 Buildout

	Permitted Left-Turn Phasing (w/ Right-Turn Overlap)				Protected Left-Turn Phasing							
Critical Movement:	EBLT	EBR	WBL	WBTR	NBL	NBTR	SBL	SBT	Sum of Critical Flow Ratios:	0.72	Critical Intersection V/C:	0.79
Adjusted Flow Rate:	225	587	17	8	886	963	5	798	Cycle Length (seconds):	95		
Saturated Flow:	1219	1223	763	1496	3319	3454	1654	3300	Lost Time per phase (seconds):	4		
Flow Ratio:	0.18	0.48	0.02	0.01	0.27	0.28	0.00	0.24	Number of Phases	2		
	0.48				0.24							

2026 Buildout

	Permitted Left-Turn Phasing (w/ Right-Turn Overlap)				Protected Left-Turn Phasing							
Critical Movement:	EBLT	EBR	WBL	WBTR	NBL	NBTR	SBL	SBT	Sum of Critical Flow Ratios:	0.74	Critical Intersection V/C:	0.85
Adjusted Flow Rate:	235	571	18	9	920	1017	7	885	Cycle Length (seconds):	95		
Saturated Flow:	1215	1223	775	1493	3319	3456	1654	3300	Lost Time per phase (seconds):	4		
Flow Ratio:	0.19	0.47	0.02	0.01	0.28	0.29	0.00	0.27	Number of Phases	3		
	0.19				0.55							

2026 Buildout w/ BCE

	Permitted Left-Turn Phasing (w/ Right-Turn Overlap)				Protected Left-Turn Phasing							
Critical Movement:	EBLT	EBR	WBL	WBTR	NBL	NBTR	SBL	SBT	Sum of Critical Flow Ratios:	0.74	Critical Intersection V/C:	0.85
Adjusted Flow Rate:	235	571	18	9	920	1017	7	885	Cycle Length (seconds):	95		
Saturated Flow:	1215	1223	775	1493	3319	3456	1654	3300	Lost Time per phase (seconds):	4		
Flow Ratio:	0.19	0.47	0.02	0.01	0.28	0.29	0.00	0.27	Number of Phases	3		
	0.19				0.55							

Notes:

Since EB and WB left-turn phases are permitted, critical ring is maximum of any left or through lane group unless $EBR > EBT+NBL$ or $WBR > WBT+SBL$.

Since NB and SB left-turn phases are protected, critical ring is either $NBL+SBL$ or $NBL+SBT$ unless $EBR > EBT+NBL$ or $WBR > WBT+SBL$.

Signalized Intersection V/C Calculation Summary

MORNING PEAK HOUR

Intersection 10: I-5 Southbound Ramps at SW Elligson Road

2021 Existing	Unique Phasing		Unique Overlap				
Critical Movement:	EBT	WBT	SBLT	SBR	Sum of Critical Flow Ratios:	0.79	Critical Intersection V/C: 0.86
Adjusted Flow Rate:	920	715	522	971	Cycle Length (seconds):	95	
Saturated Flow:	3034	3406	3146	1679	Lost Time per phase (seconds):	4	
Flow Ratio:	0.30	0.21	0.17	0.58	Number of Phases	2	
2024 Background	Unique Phasing		Unique Overlap				
Critical Movement:	EBT	WBT	SBLT	SBR	Sum of Critical Flow Ratios:	0.84	Critical Intersection V/C: 0.91
Adjusted Flow Rate:	976	757	553	1030	Cycle Length (seconds):	95	
Saturated Flow:	3034	3406	3146	1679	Lost Time per phase (seconds):	4	
Flow Ratio:	0.32	0.22	0.18	0.61	Number of Phases	2	
2026 Background	Unique Phasing		Unique Overlap				
Critical Movement:	EBT	WBT	SBLT	SBR	Sum of Critical Flow Ratios:	0.87	Critical Intersection V/C: 0.96
Adjusted Flow Rate:	1021	788	574	1080	Cycle Length (seconds):	95	
Saturated Flow:	3034	3406	3146	1679	Lost Time per phase (seconds):	4	
Flow Ratio:	0.34	0.23	0.18	0.64	Number of Phases	2	
2024 Buildout	Unique Phasing		Unique Overlap				
Critical Movement:	EBT	WBT	SBLT	SBR	Sum of Critical Flow Ratios:	0.85	Critical Intersection V/C: 0.92
Adjusted Flow Rate:	998	764	553	1043	Cycle Length (seconds):	95	
Saturated Flow:	3034	3406	3146	1679	Lost Time per phase (seconds):	4	
Flow Ratio:	0.33	0.22	0.18	0.62	Number of Phases	2	
2026 Buildout	Unique Phasing		Unique Overlap				
Critical Movement:	EBT	WBT	SBLT	SBR	Sum of Critical Flow Ratios:	0.88	Critical Intersection V/C: 0.96
Adjusted Flow Rate:	1076	803	574	1081	Cycle Length (seconds):	95	
Saturated Flow:	3034	3406	3146	1679	Lost Time per phase (seconds):	4	
Flow Ratio:	0.35	0.24	0.18	0.64	Number of Phases	2	
2026 Buildout w/ BCE	Unique Phasing		Unique Overlap				
Critical Movement:	EBT	WBT	SBLT	SBR	Sum of Critical Flow Ratios:	0.88	Critical Intersection V/C: 0.96
Adjusted Flow Rate:	1076	803	574	1082	Cycle Length (seconds):	95	
Saturated Flow:	3034	3406	3146	1679	Lost Time per phase (seconds):	4	
Flow Ratio:	0.35	0.24	0.18	0.64	Number of Phases	2	

Notes:

Since this intersection has unique phasing and overlap, the critical rings are either EBT+SBLT or WBT+SBR.

Signalized Intersection V/C Calculation Summary

MORNING PEAK HOUR

Intersection 11: I-5 Northbound Ramps at SW Elligsen Road

2021 Existing	Permitted Left-Turn Phasing			Single Approach				
Critical Movement:	EBT	WBT	NBL		Sum of Critical Flow Ratios:	0.38	Critical Intersection V/C:	0.42
Adjusted Flow Rate:	760	334	524		Cycle Length (seconds):	95		
Saturated Flow:	3329	3593	3346		Lost Time per phase (seconds):	4		
Flow Ratio:	0.23	0.09	0.16		Number of Phases	2		
	0.23			0.16				
2024 Background	Permitted Left-Turn Phasing			Single Approach				
Critical Movement:	EBT	WBT	NBL		Sum of Critical Flow Ratios:	0.41	Critical Intersection V/C:	0.45
Adjusted Flow Rate:	807	354	556		Cycle Length (seconds):	95		
Saturated Flow:	3329	3593	3346		Lost Time per phase (seconds):	4		
Flow Ratio:	0.24	0.10	0.17		Number of Phases	2		
	0.24			0.17				
2026 Background	Permitted Left-Turn Phasing			Single Approach				
Critical Movement:	EBT	WBT	NBL		Sum of Critical Flow Ratios:	0.43	Critical Intersection V/C:	0.46
Adjusted Flow Rate:	840	368	578		Cycle Length (seconds):	95		
Saturated Flow:	3329	3593	3346		Lost Time per phase (seconds):	4		
Flow Ratio:	0.25	0.10	0.17		Number of Phases	2		
	0.25			0.17				
2024 Buildout	Permitted Left-Turn Phasing			Single Approach				
Critical Movement:	EBT	WBT	NBL		Sum of Critical Flow Ratios:	0.41	Critical Intersection V/C:	0.45
Adjusted Flow Rate:	816	357	559		Cycle Length (seconds):	95		
Saturated Flow:	3329	3593	3346		Lost Time per phase (seconds):	4		
Flow Ratio:	0.25	0.10	0.17		Number of Phases	2		
	0.25			0.17				
2026 Buildout	Permitted Left-Turn Phasing			Single Approach				
Critical Movement:	EBT	WBT	NBL		Sum of Critical Flow Ratios:	0.43	Critical Intersection V/C:	0.47
Adjusted Flow Rate:	862	376	586		Cycle Length (seconds):	95		
Saturated Flow:	3329	3593	3346		Lost Time per phase (seconds):	4		
Flow Ratio:	0.26	0.10	0.18		Number of Phases	2		
	0.26			0.18				
2026 Buildout w/ BCE	Permitted Left-Turn Phasing			Single Approach				
Critical Movement:	EBT	WBT	NBL		Sum of Critical Flow Ratios:	0.43	Critical Intersection V/C:	0.47
Adjusted Flow Rate:	862	376	586		Cycle Length (seconds):	95		
Saturated Flow:	3329	2593	3346		Lost Time per phase (seconds):	4		
Flow Ratio:	0.26	0.15	0.18		Number of Phases	2		
	0.26			0.18				

Notes:

Since EB and WB left-turn phases are permitted, critical ring is maximum of any lane group.

Since only one approach exists, critical ring is max of NB lane groups or max of SB lane groups

Signalized Intersection V/C Calculation Summary

EVENING PEAK HOUR

Intersection 1: SW Sagert Street at SW Boones Ferry Road

2021 Existing	Protected/Permitted Left-Turn Phasing				Protected/Permitted Left-Turn Phasing								
Critical Movement:	EBL	EBTR	WBL	WBTR	NBL	NBTR	SBL	SBT	SBR	Sum of Critical Flow Ratios:	0.65	Critical Intersection V/C:	0.82
Adjusted Flow Rate:	56	183	223	141	22	662	90	662	60	Cycle Length (seconds):	79.3		
Saturated Flow:	1795	1866	1810	1798	1795	1732	1795	1885	1560	Lost Time per phase (seconds):	4		
Flow Ratio:	0.03	0.10	0.12	0.08	0.01	0.38	0.05	0.35	0.04	Number of Phases	4		
	0.22				0.43								
2024 Background	Protected/Permitted Left-Turn Phasing				Protected/Permitted Left-Turn Phasing								
Critical Movement:	EBL	EBTR	WBL	WBTR	NBL	NBTR	SBL	SBT	SBR	Sum of Critical Flow Ratios:	0.69	Critical Intersection V/C:	0.85
Adjusted Flow Rate:	59	193	236	132	23	699	96	701	31	Cycle Length (seconds):	84.7		
Saturated Flow:	1795	1865	1810	1826	1795	1733	1795	1885	1560	Lost Time per phase (seconds):	4		
Flow Ratio:	0.03	0.10	0.13	0.07	0.01	0.40	0.05	0.37	0.02	Number of Phases	4		
	0.23				0.46								
2026 Background	Protected/Permitted Left-Turn Phasing				Protected/Permitted Left-Turn Phasing								
Critical Movement:	EBL	EBTR	WBL	WBTR	NBL	NBTR	SBL	SBT	SBR	Sum of Critical Flow Ratios:	0.72	Critical Intersection V/C:	0.88
Adjusted Flow Rate:	62	201	249	139	24	732	99	732	29	Cycle Length (seconds):	88.4		
Saturated Flow:	1795	1866	1810	1824	1795	1733	1795	1885	1560	Lost Time per phase (seconds):	4		
Flow Ratio:	0.03	0.11	0.14	0.08	0.01	0.42	0.06	0.39	0.02	Number of Phases	4		
	0.25				0.48								
2024 Buildout	Protected/Permitted Left-Turn Phasing				Protected/Permitted Left-Turn Phasing								
Critical Movement:	EBL	EBTR	WBL	WBTR	NBL	NBTR	SBL	SBT	SBR	Sum of Critical Flow Ratios:	0.70	Critical Intersection V/C:	0.86
Adjusted Flow Rate:	59	193	246	132	23	711	96	711	31	Cycle Length (seconds):	85.8		
Saturated Flow:	1795	1865	1810	1826	1795	1733	1795	1885	1560	Lost Time per phase (seconds):	4		
Flow Ratio:	0.03	0.10	0.14	0.07	0.01	0.41	0.05	0.38	0.02	Number of Phases	4		
	0.24				0.46								
2026 Buildout	Protected/Permitted Left-Turn Phasing				Protected/Permitted Left-Turn Phasing								
Critical Movement:	EBL	EBTR	WBL	WBTR	NBL	NBTR	SBL	SBT	SBR	Sum of Critical Flow Ratios:	0.75	Critical Intersection V/C:	0.91
Adjusted Flow Rate:	62	201	275	139	24	758	99	757	29	Cycle Length (seconds):	90.6		
Saturated Flow:	1795	1866	1810	1824	1795	1734	1795	1885	1561	Lost Time per phase (seconds):	4		
Flow Ratio:	0.03	0.11	0.15	0.08	0.01	0.44	0.06	0.40	0.02	Number of Phases	4		
	0.26				0.49								
2026 Buildout w/ BCE	Protected/Permitted Left-Turn Phasing				Protected/Permitted Left-Turn Phasing								
Critical Movement:	EBL	EBTR	WBL	WBTR	NBL	NBTR	SBL	SBT	SBR	Sum of Critical Flow Ratios:	0.75	Critical Intersection V/C:	0.91
Adjusted Flow Rate:	62	201	275	139	24	760	99	757	29	Cycle Length (seconds):	90.8		
Saturated Flow:	1795	1866	1810	1798	1795	1732	1795	1885	1561	Lost Time per phase (seconds):	4		
Flow Ratio:	0.03	0.11	0.15	0.08	0.01	0.44	0.06	0.40	0.02	Number of Phases	4		
	0.26				0.49								

Notes:

Since EB and WB left-turn phases are protected, critical ring is either EBL+WBTR or WBL+EBTR - HCM6 does not show reductions for permitted left turns
 Since NB and SB left-turn phases are protected, critical ring is either NBL+SBT or SBL+NBTR - HCM6 does not show reductions for permitted left turns

Signalized Intersection V/C Calculation Summary

EVENING PEAK HOUR

Intersection 2: SW Avery Road at SW Boones Ferry Road

2021 Existing	Protected/Permitted Left-Turn Phasing				Protected/Permitted Left-Turn Phasing							
Critical Movement:	EBL	EBTR	WBL	WBTR	NBL	NBTR	SBL	SBTR				
Adjusted Flow Rate:	244	382	50	51	110	460	14	824	Sum of Critical Flow Ratios:	0.78	Critical Intersection V/C:	0.92
Saturated Flow:	1753	1605	1781	1816	1725	1777	1781	1828	Cycle Length (seconds):	103.4		
Flow Ratio:	0.14	0.24	0.03	0.03	0.06	0.26	0.01	0.45	Lost Time per phase (seconds):	4		
	0.27				0.51				Number of Phases	4		
2024 Background	Protected/Permitted Left-Turn Phasing				Protected/Permitted Left-Turn Phasing							
Critical Movement:	EBL	EBTR	WBL	WBTR	NBL	NBTR	SBL	SBTR				
Adjusted Flow Rate:	258	332	53	48	117	482	15	874	Sum of Critical Flow Ratios:	0.78	Critical Intersection V/C:	0.92
Saturated Flow:	1753	1624	1781	1848	1725	1781	1781	1829	Cycle Length (seconds):	106.8		
Flow Ratio:	0.15	0.20	0.03	0.03	0.07	0.27	0.01	0.48	Lost Time per phase (seconds):	4		
	0.23				0.55				Number of Phases	4		
2026 Background	Protected/Permitted Left-Turn Phasing				Protected/Permitted Left-Turn Phasing							
Critical Movement:	EBL	EBTR	WBL	WBTR	NBL	NBTR	SBL	SBTR				
Adjusted Flow Rate:	268	351	55	51	124	506	15	917	Sum of Critical Flow Ratios:	0.82	Critical Intersection V/C:	0.96
Saturated Flow:	1753	1623	1781	1842	1725	1781	1781	1829	Cycle Length (seconds):	113.5		
Flow Ratio:	0.15	0.22	0.03	0.03	0.07	0.28	0.01	0.50	Lost Time per phase (seconds):	4		
	0.25				0.57				Number of Phases	4		
2024 Buildout	Protected/Permitted Left-Turn Phasing				Protected/Permitted Left-Turn Phasing							
Critical Movement:	EBL	EBTR	WBL	WBTR	NBL	NBTR	SBL	SBTR				
Adjusted Flow Rate:	258	341	53	48	122	493	15	893	Sum of Critical Flow Ratios:	0.80	Critical Intersection V/C:	0.93
Saturated Flow:	1753	1621	1781	1848	1725	1782	1781	1829	Cycle Length (seconds):	110.8		
Flow Ratio:	0.15	0.21	0.03	0.03	0.07	0.28	0.01	0.49	Lost Time per phase (seconds):	4		
	0.24				0.56				Number of Phases	4		
2026 Buildout	Protected/Permitted Left-Turn Phasing				Protected/Permitted Left-Turn Phasing							
Critical Movement:	EBL	EBTR	WBL	WBTR	NBL	NBTR	SBL	SBTR				
Adjusted Flow Rate:	268	374	55	51	138	534	15	965	Sum of Critical Flow Ratios:	0.87	Critical Intersection V/C:	1.01
Saturated Flow:	1753	1616	1781	1842	1725	1783	1781	1831	Cycle Length (seconds):	117		
Flow Ratio:	0.15	0.23	0.03	0.03	0.08	0.30	0.01	0.53	Lost Time per phase (seconds):	4		
	0.26				0.61				Number of Phases	4		
2026 Buildout w/ BCE	Protected/Permitted Left-Turn Phasing				Protected/Permitted Left-Turn Phasing							
Critical Movement:	EBL	EBTR	WBL	WBTR	NBL	NBTR	SBL	SBTR				
Adjusted Flow Rate:	268	362	55	51	131	533	15	965	Sum of Critical Flow Ratios:	0.86	Critical Intersection V/C:	0.99
Saturated Flow:	1753	1619	1781	1841	1725	1782	1781	1831	Cycle Length (seconds):	116.7		
Flow Ratio:	0.15	0.22	0.03	0.03	0.08	0.30	0.01	0.53	Lost Time per phase (seconds):	4		
	0.25				0.60				Number of Phases	4		

Notes:

Since EB and WB left-turn phases are protected, critical ring is either EBL+WBT or WBL+EBT - HCM6 does not show reductions for permitted left turns
 Since NB and SB left-turn phases are protected, critical ring is either NBL+SBT or SBL+NBT - HCM6 does not show reductions for permitted left turns

Signalized Intersection V/C Calculation Summary

EVENING PEAK HOUR

Intersection 3: SW Ibach Street at SW Boones Ferry Road

2021 Existing	Permitted Left-Turn Phasing				Protected/Permitted Left-Turn Phasing							
Critical Movement:	EBL	EBTR	WBLTR	NBL	NBTR	SBL	SBT	SBR	Sum of Critical Flow Ratios:	0.63	Critical Intersection V/C:	0.75
Adjusted Flow Rate:	156	141	8	191	409	11	756	206	Cycle Length (seconds):	72.5		
Saturated Flow:	1369	1560	1180	1753	1840	1781	1870	1573	Lost Time per phase (seconds):	4		
Flow Ratio:	0.11	0.09	0.01	0.11	0.22	0.01	0.40	0.13	Number of Phases	3		
	0.11			0.51								
2024 Background	Permitted Left-Turn Phasing				Protected/Permitted Left-Turn Phasing							
Critical Movement:	EBL	EBTR	WBLTR	NBL	NBTR	SBL	SBT	SBR	Sum of Critical Flow Ratios:	0.67	Critical Intersection V/C:	0.79
Adjusted Flow Rate:	166	62	9	202	435	12	802	235	Cycle Length (seconds):	78		
Saturated Flow:	1349	1558	1541	1753	1839	1781	1870	1573	Lost Time per phase (seconds):	4		
Flow Ratio:	0.12	0.04	0.01	0.12	0.24	0.01	0.43	0.15	Number of Phases	3		
	0.12			0.54								
2026 Background	Permitted Left-Turn Phasing				Protected/Permitted Left-Turn Phasing							
Critical Movement:	EBL	EBTR	WBLTR	NBL	NBTR	SBL	SBT	SBR	Sum of Critical Flow Ratios:	0.70	Critical Intersection V/C:	0.82
Adjusted Flow Rate:	172	68	10	209	458	12	844	245	Cycle Length (seconds):	82.6		
Saturated Flow:	1348	1559	1542	1753	1839	1781	1870	1573	Lost Time per phase (seconds):	4		
Flow Ratio:	0.13	0.04	0.01	0.12	0.25	0.01	0.45	0.16	Number of Phases	3		
	0.13			0.57								
2024 Buildout	Permitted Left-Turn Phasing				Protected/Permitted Left-Turn Phasing							
Critical Movement:	EBL	EBTR	WBLTR	NBL	NBTR	SBL	SBT	SBR	Sum of Critical Flow Ratios:	0.69	Critical Intersection V/C:	0.81
Adjusted Flow Rate:	166	67	9	205	453	12	835	235	Cycle Length (seconds):	80.9		
Saturated Flow:	1348	1558	1537	1753	1839	1781	1870	1573	Lost Time per phase (seconds):	4		
Flow Ratio:	0.12	0.04	0.01	0.12	0.25	0.01	0.45	0.15	Number of Phases	3		
	0.12			0.56								
2026 Buildout	Permitted Left-Turn Phasing				Protected/Permitted Left-Turn Phasing							
Critical Movement:	EBL	EBTR	WBLTR	NBL	NBTR	SBL	SBT	SBR	Sum of Critical Flow Ratios:	0.74	Critical Intersection V/C:	0.86
Adjusted Flow Rate:	172	79	10	217	53	12	921	245	Cycle Length (seconds):	88		
Saturated Flow:	1347	1558	1536	1753	1839	1781	1870	1574	Lost Time per phase (seconds):	4		
Flow Ratio:	0.13	0.05	0.01	0.12	0.03	0.01	0.49	0.16	Number of Phases	3		
	0.13			0.62								
2026 Buildout w/ BCE	Permitted Left-Turn Phasing				Protected/Permitted Left-Turn Phasing							
Critical Movement:	EBL	EBTR	WBLTR	NBL	NBTR	SBL	SBT	SBR	Sum of Critical Flow Ratios:	0.74	Critical Intersection V/C:	0.85
Adjusted Flow Rate:	172	75	10	214	496	12	908	245	Cycle Length (seconds):	87.1		
Saturated Flow:	1347	1558	1537	1753	1839	1781	1870	1574	Lost Time per phase (seconds):	4		
Flow Ratio:	0.13	0.05	0.01	0.12	0.27	0.01	0.49	0.16	Number of Phases	3		
	0.13			0.61								

Notes:

Since EB and WB left-turn phases are permitted, critical ring is maximum of any lane group.

Since NB and SB left-turn phases are protected, critical ring is either EBL+WBT or WBL+EBT - HCM6 does not show reductions for permitted left turns

Signalized Intersection V/C Calculation Summary

EVENING PEAK HOUR

Intersection 8: SW Day Road at SW Boones Ferry Road

2021 Existing	Permitted Left-Turn Phasing (w/ Right-Turn Overlap)			Protected Left-Turn Phasing							
Critical Movement:	EBLT	EBR	WBLTR	NBL	NBTR	SBL	SBTR	Sum of Critical Flow Ratios:	0.56	Critical Intersection V/C:	0.61
Adjusted Flow Rate:	3	568	0	616	560	0	740	Cycle Length (seconds):	105		
Saturated Flow:	1418	1585	1900	2827	1856	1795	3621	Lost Time per phase (seconds):	4		
Flow Ratio:	0.00	0.36	0.00	0.22	0.30	0.00	0.20	Number of Phases	2		
	0.36			0.20							
2024 Background	Permitted Left-Turn Phasing (w/ Right-Turn Overlap)			Protected Left-Turn Phasing							
Critical Movement:	EBLT	EBR	WBLTR	NBL	NBTR	SBL	SBTR	Sum of Critical Flow Ratios:	0.65	Critical Intersection V/C:	0.71
Adjusted Flow Rate:	3	695	0	653	594	0	782	Cycle Length (seconds):	105		
Saturated Flow:	1418	1585	1900	2827	1856	1795	3622	Lost Time per phase (seconds):	4		
Flow Ratio:	0.00	0.44	0.00	0.23	0.32	0.00	0.22	Number of Phases	2		
	0.44			0.22							
2026 Background	Permitted Left-Turn Phasing (w/ Right-Turn Overlap)			Protected Left-Turn Phasing							
Critical Movement:	EBLT	EBR	WBLTR	NBL	NBTR	SBL	SBTR	Sum of Critical Flow Ratios:	0.72	Critical Intersection V/C:	0.78
Adjusted Flow Rate:	6	777	0	678	628	0	820	Cycle Length (seconds):	105		
Saturated Flow:	1418	1585	1900	2827	1856	1795	3622	Lost Time per phase (seconds):	4		
Flow Ratio:	0.00	0.49	0.00	0.24	0.34	0.00	0.23	Number of Phases	2		
	0.49			0.23							
2024 Buildout	Permitted Left-Turn Phasing (w/ Right-Turn Overlap)			Protected Left-Turn Phasing							
Critical Movement:	EBLT	EBR	WBLTR	NBL	NBTR	SBL	SBTR	Sum of Critical Flow Ratios:	0.69	Critical Intersection V/C:	0.75
Adjusted Flow Rate:	12	746	0	653	627	0	808	Cycle Length (seconds):	105		
Saturated Flow:	1418	1585	1900	2827	1856	1795	3619	Lost Time per phase (seconds):	4		
Flow Ratio:	0.01	0.47	0.00	0.23	0.34	0.00	0.22	Number of Phases	2		
	0.47			0.22							
2026 Buildout	Permitted Left-Turn Phasing (w/ Right-Turn Overlap)			Protected Left-Turn Phasing							
Critical Movement:	EBLT	EBR	WBLTR	NBL	NBTR	SBL	SBTR	Sum of Critical Flow Ratios:	0.73	Critical Intersection V/C:	0.79
Adjusted Flow Rate:	30	777	0	678	709	0	881	Cycle Length (seconds):	105		
Saturated Flow:	1418	1585	1900	2827	1856	1795	3615	Lost Time per phase (seconds):	4		
Flow Ratio:	0.02	0.49	0.00	0.24	0.38	0.00	0.24	Number of Phases	2		
	0.49			0.24							
2026 Buildout w/ BCE	Permitted Left-Turn Phasing (w/ Right-Turn Overlap)			Protected Left-Turn Phasing							
Critical Movement:	EBLT	EBR	WBLTR	NBL	NBTR	SBL	SBTR	Sum of Critical Flow Ratios:	0.62	Critical Intersection V/C:	0.67
Adjusted Flow Rate:	6	529	0	474	912	0	1061	Cycle Length (seconds):	105		
Saturated Flow:	1418	1585	1900	2827	1856	1795	3667	Lost Time per phase (seconds):	4		
Flow Ratio:	0.00	0.33	0.00	0.17	0.49	0.00	0.29	Number of Phases	2		
	0.33			0.29							

Notes:

Since EB and WB left-turn phases are permitted, critical ring is maximum of any left or through lane group unless $EBR > EBT+NBL$ or $WBR > WBT+SBL$.

Since NB and SB left-turn phases are protected, critical ring is either $NBL+SBT$ or $SBL+NBT$ unless $EBR > EBT+NBL$ or $WBR > WBT+SBL$.

Signalized Intersection V/C Calculation Summary

EVENING PEAK HOUR

Intersection 9: SW 95th Avenue at SW Boones Ferry Road

2021 Existing

	Permitted Left-Turn Phasing (w/ Right-Turn Overlap)				Protected Left-Turn Phasing							
Critical Movement:	EBLT	EBR	WBL	WBTR	NBL	NBTR	SBL	SBT	Sum of Critical Flow Ratios:	0.67	Critical Intersection V/C:	0.76
Adjusted Flow Rate:	229	790	47	23	573	886	3	1121	Cycle Length (seconds):	105		
Saturated Flow:	1260	2634	685	1784	3291	3466	1767	3526	Lost Time per phase (seconds):	4		
Flow Ratio:	0.18	0.30	0.07	0.01	0.17	0.26	0.00	0.32	Number of Phases	3		
	0.18				0.49							

2024 Background

	Permitted Left-Turn Phasing (w/ Right-Turn Overlap)				Protected Left-Turn Phasing							
Critical Movement:	EBLT	EBR	WBL	WBTR	NBL	NBTR	SBL	SBT	Sum of Critical Flow Ratios:	0.72	Critical Intersection V/C:	0.81
Adjusted Flow Rate:	243	836	50	24	607	939	3	1189	Cycle Length (seconds):	105		
Saturated Flow:	1255	2634	656	1787	3291	3466	1767	3526	Lost Time per phase (seconds):	4		
Flow Ratio:	0.19	0.32	0.08	0.01	0.18	0.27	0.00	0.34	Number of Phases	3		
	0.19				0.52							

2026 Background

	Permitted Left-Turn Phasing (w/ Right-Turn Overlap)				Protected Left-Turn Phasing							
Critical Movement:	EBLT	EBR	WBL	WBTR	NBL	NBTR	SBL	SBT	Sum of Critical Flow Ratios:	0.75	Critical Intersection V/C:	0.84
Adjusted Flow Rate:	252	869	52	26	630	986	3	1241	Cycle Length (seconds):	105		
Saturated Flow:	1244	2634	636	1782	3291	3466	1767	3526	Lost Time per phase (seconds):	4		
Flow Ratio:	0.20	0.33	0.08	0.01	0.19	0.28	0.00	0.35	Number of Phases	3		
	0.20				0.54							

2024 Buildout

	Permitted Left-Turn Phasing (w/ Right-Turn Overlap)				Protected Left-Turn Phasing							
Critical Movement:	EBLT	EBR	WBL	WBTR	NBL	NBTR	SBL	SBT	Sum of Critical Flow Ratios:	0.72	Critical Intersection V/C:	0.81
Adjusted Flow Rate:	243	836	50	24	607	972	3	1207	Cycle Length (seconds):	105		
Saturated Flow:	1255	2634	656	1787	3291	3466	1767	3526	Lost Time per phase (seconds):	4		
Flow Ratio:	0.19	0.32	0.08	0.01	0.18	0.28	0.00	0.34	Number of Phases	3		
	0.19				0.53							

2026 Buildout

	Permitted Left-Turn Phasing (w/ Right-Turn Overlap)				Protected Left-Turn Phasing							
Critical Movement:	EBLT	EBR	WBL	WBTR	NBL	NBTR	SBL	SBT	Sum of Critical Flow Ratios:	0.76	Critical Intersection V/C:	0.86
Adjusted Flow Rate:	252	869	52	26	630	1069	3	1289	Cycle Length (seconds):	105		
Saturated Flow:	1244	2634	636	1781	3291	3467	1767	3526	Lost Time per phase (seconds):	4		
Flow Ratio:	0.20	0.33	0.08	0.01	0.19	0.31	0.00	0.37	Number of Phases	3		
	0.20				0.56							

2026 Buildout w/ BCE

	Permitted Left-Turn Phasing (w/ Right-Turn Overlap)				Protected Left-Turn Phasing							
Critical Movement:	EBLT	EBR	WBL	WBTR	NBL	NBTR	SBL	SBT	Sum of Critical Flow Ratios:	0.76	Critical Intersection V/C:	0.86
Adjusted Flow Rate:	252	869	52	26	630	1069	3	1289	Cycle Length (seconds):	105		
Saturated Flow:	1251	2723	636	1781	3291	3467	1767	3526	Lost Time per phase (seconds):	4		
Flow Ratio:	0.20	0.32	0.08	0.01	0.19	0.31	0.00	0.37	Number of Phases	3		
	0.20				0.56							

Notes:

Since EB and WB left-turn phases are permitted, critical ring is maximum of any left or through lane group unless $EBR > EBT+NBL$ or $WBR > WBT+SBL$.

Since NB and SB left-turn phases are protected, critical ring is either $NBL+SBL$ or $SBL+NBTR$ unless $EBR > EBT+NBL$ or $WBR > WBT+SBL$.

Signalized Intersection V/C Calculation Summary

EVENING PEAK HOUR

Intersection 10: I-5 Southbound Ramps at SW Elligson Road

2021 Existing

	Unique Phasing		Unique Overlap				
Critical Movement:	EBT	WBT	SBLT	SBR	Sum of Critical Flow Ratios:	0.60	Critical Intersection V/C: 0.65
Adjusted Flow Rate:	1058	663	646	700	Cycle Length (seconds):	105	
Saturated Flow:	3505	3505	3230	1711	Lost Time per phase (seconds):	4	
Flow Ratio:	0.30	0.19	0.20	0.41	Number of Phases	2	

2024 Background

	Unique Phasing		Unique Overlap				
Critical Movement:	EBT	WBT	SBLT	SBR	Sum of Critical Flow Ratios:	0.65	Critical Intersection V/C: 0.70
Adjusted Flow Rate:	1122	703	685	761	Cycle Length (seconds):	105	
Saturated Flow:	3505	3505	3230	1711	Lost Time per phase (seconds):	4	
Flow Ratio:	0.32	0.20	0.21	0.44	Number of Phases	2	

2026 Background

	Unique Phasing		Unique Overlap				
Critical Movement:	EBT	WBT	SBLT	SBR	Sum of Critical Flow Ratios:	0.68	Critical Intersection V/C: 0.74
Adjusted Flow Rate:	1169	735	709	810	Cycle Length (seconds):	105	
Saturated Flow:	3505	3505	3230	1711	Lost Time per phase (seconds):	4	
Flow Ratio:	0.33	0.21	0.22	0.47	Number of Phases	2	

2024 Buildout

	Unique Phasing		Unique Overlap				
Critical Movement:	EBT	WBT	SBLT	SBR	Sum of Critical Flow Ratios:	0.66	Critical Intersection V/C: 0.72
Adjusted Flow Rate:	1135	722	685	781	Cycle Length (seconds):	105	
Saturated Flow:	3505	3505	3230	1711	Lost Time per phase (seconds):	4	
Flow Ratio:	0.32	0.21	0.21	0.46	Number of Phases	2	

2026 Buildout

	Unique Phasing		Unique Overlap				
Critical Movement:	EBT	WBT	SBLT	SBR	Sum of Critical Flow Ratios:	0.72	Critical Intersection V/C: 0.78
Adjusted Flow Rate:	1203	782	709	857	Cycle Length (seconds):	105	
Saturated Flow:	3505	3505	3230	1711	Lost Time per phase (seconds):	4	
Flow Ratio:	0.34	0.22	0.22	0.50	Number of Phases	2	

2026 Buildout w/ BCE

	Unique Phasing		Unique Overlap				
Critical Movement:	EBT	WBT	SBLT	SBR	Sum of Critical Flow Ratios:	0.72	Critical Intersection V/C: 0.78
Adjusted Flow Rate:	1203	782	709	857	Cycle Length (seconds):	105	
Saturated Flow:	3505	3505	3230	1711	Lost Time per phase (seconds):	4	
Flow Ratio:	0.34	0.22	0.22	0.50	Number of Phases	2	

Notes:

Since this intersection has unique phasing and overlap, the critical rings are either EBT+SBLT or WBT+SBR.

Signalized Intersection V/C Calculation Summary

EVENING PEAK HOUR

Intersection 11: I-5 Northbound Ramps at SW Elligsen Road

2021 Existing	Permitted Left-Turn Phasing			Single Approach				
Critical Movement:	EBT	WBT	NBL		Sum of Critical Flow Ratios:	0.38	Critical Intersection V/C:	0.41
Adjusted Flow Rate:	1010	771	325		Cycle Length (seconds):	105		
Saturated Flow:	3589	3770	3401		Lost Time per phase (seconds):	4		
Flow Ratio:	0.28	0.20	0.10		Number of Phases	2		
	0.28			0.10				
2024 Background	Permitted Left-Turn Phasing			Single Approach				
Critical Movement:	EBT	WBT	NBL		Sum of Critical Flow Ratios:	0.40	Critical Intersection V/C:	0.43
Adjusted Flow Rate:	1070	818	345		Cycle Length (seconds):	105		
Saturated Flow:	3589	3770	3401		Lost Time per phase (seconds):	4		
Flow Ratio:	0.30	0.22	0.10		Number of Phases	2		
	0.30			0.10				
2026 Background	Permitted Left-Turn Phasing			Single Approach				
Critical Movement:	EBT	WBT	NBL		Sum of Critical Flow Ratios:	0.42	Critical Intersection V/C:	0.45
Adjusted Flow Rate:	1113	852	362		Cycle Length (seconds):	105		
Saturated Flow:	3589	3770	3401		Lost Time per phase (seconds):	4		
Flow Ratio:	0.31	0.23	0.11		Number of Phases	2		
	0.31			0.11				
2024 Buildout	Permitted Left-Turn Phasing			Single Approach				
Critical Movement:	EBT	WBT	NBL		Sum of Critical Flow Ratios:	0.40	Critical Intersection V/C:	0.44
Adjusted Flow Rate:	1076	827	355		Cycle Length (seconds):	105		
Saturated Flow:	3589	3770	3401		Lost Time per phase (seconds):	4		
Flow Ratio:	0.30	0.22	0.10		Number of Phases	2		
	0.30			0.10				
2026 Buildout	Permitted Left-Turn Phasing			Single Approach				
Critical Movement:	EBT	WBT	NBL		Sum of Critical Flow Ratios:	0.43	Critical Intersection V/C:	0.46
Adjusted Flow Rate:	1127	877	387		Cycle Length (seconds):	105		
Saturated Flow:	3589	3770	3401		Lost Time per phase (seconds):	4		
Flow Ratio:	0.31	0.23	0.11		Number of Phases	2		
	0.31			0.11				
2026 Buildout w/ BCE	Permitted Left-Turn Phasing			Single Approach				
Critical Movement:	EBT	WBT	NBL		Sum of Critical Flow Ratios:	0.43	Critical Intersection V/C:	0.46
Adjusted Flow Rate:	1127	877	387		Cycle Length (seconds):	105		
Saturated Flow:	3589	3770	3401		Lost Time per phase (seconds):	4		
Flow Ratio:	0.31	0.23	0.11		Number of Phases	2		
	0.31			0.11				

Notes:

Since EB and WB left-turn phases are permitted, critical ring is maximum of any lane group.

Since only one approach exists, critical ring is max of NB lane groups or max of SB lane groups

Signalized Intersection V/C Calculation Summary

MORNING PEAK HOUR

Intersection 7: SW Basalt Creek Parkway at SW Boones Ferry Road

2026 Buildout w/ BCE	Permitted Left-Turn Phasing (w/ Right-Turn Overlap)		Protected Left-Turn Phasing					
Critical Movement:	EBLT	EBR	NBL	NBTR	SBTR	Sum of Critical Flow Ratios:	0.75	Critical Intersection V/C: 0.86
Adjusted Flow Rate:	176	334	369	640	785	Cycle Length (seconds):	95	
Saturated Flow:	1810	1610	1725	1811	1790	Lost Time per phase (seconds):	4	
Flow Ratio:	0.10	0.21	0.21	0.35	0.44	Number of Phases	3	
	0.10		0.65					

EVENING PEAK HOUR

Intersection 7: SW Basalt Creek Parkway at SW Boones Ferry Road

2026 Buildout w/ BCE	Permitted Left-Turn Phasing (w/ Right-Turn Overlap)		Protected Left-Turn Phasing					
Critical Movement:	EBLT	EBR	NBL	NBTR	SBTR	Sum of Critical Flow Ratios:	0.66	Critical Intersection V/C: 0.72
Adjusted Flow Rate:	41	256	209	738	925	Cycle Length (seconds):	105	
Saturated Flow:	1810	1610	1767	1856	1841	Lost Time per phase (seconds):	4	
Flow Ratio:	0.02	0.16	0.12	0.40	0.50	Number of Phases	2	
	0.16		0.50					

Notes:

Since EB and WB left-turn phases are permitted, critical ring is maximum of any left or through lane group unless $EBR > EBT+NBL$ or $WBR > WBT+SBL$.

Since NB and SB left-turn phases are protected, critical ring is either $NBL+SBT$ or $SBL+NBT$ unless $EBR > EBT+NBL$ or $WBR > WBT+SBL$.

Signalized Intersection V/C Calculation Summary

EVENING PEAK HOUR

Intersection 10: I-5 Southbound Ramps at SW Elligson Road + RTP Ramp Project #11489

	Unique Phasing		Unique Overlap				
2026 Background AM							
Critical Movement:	EBT	WBT	SBLT	SBR	Sum of Critical Flow Ratios:	0.58	Critical Intersection V/C: 0.63
Adjusted Flow Rate:	1021	788	574	1024	Cycle Length (seconds):	95	
Saturated Flow:	3034	3406	3146	2955	Lost Time per phase (seconds):	4	
Flow Ratio:	0.34	0.23	0.18	0.35	Number of Phases	2	
2026 Buildout AM							
Critical Movement:	EBT	WBT	SBLT	SBR	Sum of Critical Flow Ratios:	0.60	Critical Intersection V/C: 0.66
Adjusted Flow Rate:	1076	803	574	1090	Cycle Length (seconds):	95	
Saturated Flow:	3034	3406	3146	2955	Lost Time per phase (seconds):	4	
Flow Ratio:	0.35	0.24	0.18	0.37	Number of Phases	2	
2026 Background PM							
Critical Movement:	EBT	WBT	SBLT	SBR	Sum of Critical Flow Ratios:	0.55	Critical Intersection V/C: 0.60
Adjusted Flow Rate:	1169	735	709	786	Cycle Length (seconds):	105	
Saturated Flow:	3505	3505	3230	3011	Lost Time per phase (seconds):	4	
Flow Ratio:	0.33	0.21	0.22	0.26	Number of Phases	2	
2026 Buildout PM							
Critical Movement:	EBT	WBT	SBLT	SBR	Sum of Critical Flow Ratios:	0.56	Critical Intersection V/C: 0.61
Adjusted Flow Rate:	1203	782	709	835	Cycle Length (seconds):	105	
Saturated Flow:	3505	3505	3230	3011	Lost Time per phase (seconds):	4	
Flow Ratio:	0.34	0.22	0.22	0.28	Number of Phases	2	

Notes:
 Since this intersection has unique phasing and overlap, the critical rings are either EBT+SBLT or WBT+SBR.

Intersection: 6: SW Boones Ferry Road & Site Access

Movement	EB	WB	WB	NB	NB	NB	SB	SB
Directions Served	LTR	LT	R	L	T	R	L	TR
Maximum Queue (ft)	31	187	128	6	72	10	44	32
Average Queue (ft)	4	65	24	0	6	0	9	2
95th Queue (ft)	19	136	60	4	35	6	32	15
Link Distance (ft)	318	1445			601			1805
Upstream Blk Time (%)								
Queuing Penalty (veh)								
Storage Bay Dist (ft)			150	150		150	150	
Storage Blk Time (%)		4						
Queuing Penalty (veh)		2						

Network Summary

Network wide Queuing Penalty: 2

Intersection: 6: SW Boones Ferry Road & Site Access

Movement	EB	WB	WB	NB	NB	NB	SB	SB
Directions Served	LTR	LT	R	L	T	R	L	TR
Maximum Queue (ft)	18	109	29	30	22	26	55	38
Average Queue (ft)	2	40	13	1	1	1	19	2
95th Queue (ft)	13	84	29	10	10	13	44	17
Link Distance (ft)	318	1810			670			1804
Upstream Blk Time (%)								
Queuing Penalty (veh)								
Storage Bay Dist (ft)			150	150		150	150	
Storage Blk Time (%)		0						
Queuing Penalty (veh)		0						

Appendix E – Commercial Scenarios

Memorandum: Supplement to Autumn Subdivision TIS
Evaluation of Potential Commercial



Memorandum

To: Mike McCarthy, City of Tualatin
Copy: David Force, Lennar Northwest
Mimi Doukas, AKS Engineering & Forestry, LLC
From: Jennifer Danziger, PE,
Date: September 20, 2021
Subject: Supplement to Autumn Subdivision TIS – Evaluation of Potential Commercial



RENEWS: 12.31.21

Introduction

This memorandum supplements the proposed Autumn Sunrise Subdivision Transportation Impact Study (TIS) with three development alternatives on the commercially-zoned parcels abutting SW Boones Ferry Road. These parcels are not part of the subdivision; the specific timing and type of development that could occur on these parcels is unknown.

Commercial Development Concepts

The Neighborhood Commercial (CN) zoning abutting SW Boones Ferry Road will be divided into two parcels to accommodate the proposed Autumn Sunrise site access at SW Boones Ferry Road. The attached site plan shows how the area could potentially be developed. In addition to the proposed stormwater facility, the parcel could accommodate a 3,600-square-foot (SF) building with parking north of the site access and a 10,000-SF building with parking to the south. Both parking lots would take access from the proposed site access approximately 100 feet east of SW Boones Ferry Road.

Tualatin Development Code (TDC) Chapter 51 establishes the standards for the CN zone. According to the TDC, “the primary uses are intended to include professional offices, services, and retail oriented to the day-to-day needs of adjacent neighborhoods.” Commercial uses in the CN zone are extremely limited. With that in mind, and considering community feedback at public meetings, two potential concepts were developed for the two buildings:

1. 13,600 SF of general retail in the two buildings
2. 5,000 SF of day care center in one building plus 8,600 of general retail in the remaining space

Trip Generation

To estimate trips generated by the three potential development concepts, trip rates from the *Trip Generation Manual*¹ were used. Within the general retail, permitted uses under TDC Chapter 51 are limited to general

¹ Institute of Transportation Engineers (ITE), *Trip Generation Manual*, 10th Edition, 2017.

merchandise or variety stores such as small food stores (<4,000 SF), drug stores, laundry and dry cleaning, beauty and barber shops, and shoe repair. Trip generation rates for many of these uses are non-existent or very limited; therefore, Land Use 820 – *Shopping Center* was applied for the general retail components of the concepts. Land Use 565 – *Day Care Center* was applied for the other concept. All trip generation is based on gross floor area. Table 1 presents a comparison of trip generation for the three development concepts.

Table 1: Trip Generation Summary

Description (ITE Code)	Intensity (DU)	Morning Peak Hour			Evening Peak Hour			Daily Trips
		In	Out	Total	In	Out	Total	
Concept 1								
Shopping Center (820)	13.6 KSF	8	5	13	25	27	52	514
<i>Internal with Autumn Sunrise</i>		-1	-1	-2	-3	-7	-10	NA
Total External		7	4	11	22	20	42	NA
Concept 2								
Day Care Center (565)	5 KSF	29	26	55	26	30	56	119
Shopping Center (820)	8.6 KSF	5	3	8	16	17	33	324
Subtotal		34	29	63	42	47	89	443
<i>Internal with Autumn Sunrise</i>		-2	-1	-3	-4	-12	-16	NA
Total External		32	28	60	38	35	73	NA

Although some of the uses may attract pass-by trips, the analysis was performed assuming all trips associated with the commercial development would pass through the site access intersection with SW Boones Ferry Road. However, trips that could be internal with the proposed Autumn Sunrise subdivision were accounted for based on the Transportation Research Board report, *Enhancing Internal Trip Capture Estimation for Mixed-Use Developments*.²

Trip Distribution

The directional distribution of potential commercial trips was assumed to be:

- Approximately 50 percent of traveling to/from the north on SW Boones Ferry Road
- Approximately 50 percent of traveling to/from the south on SW Boones Ferry Road

Trip Assignment

The resulting trip assignment is shown in Figure 1 for the site access intersection with SW Boones Ferry. Note, the intersection is shown as having four legs to account for the future configuration with a frontage road connection that will be opened with construction of the Basalt Creek Parkway Extension (BCPE).

² Transportation Research Board, National Cooperative Highway Research Program Report 684, *Enhancing Internal Trip Capture Estimation for Mixed-Use Developments*, 2006.



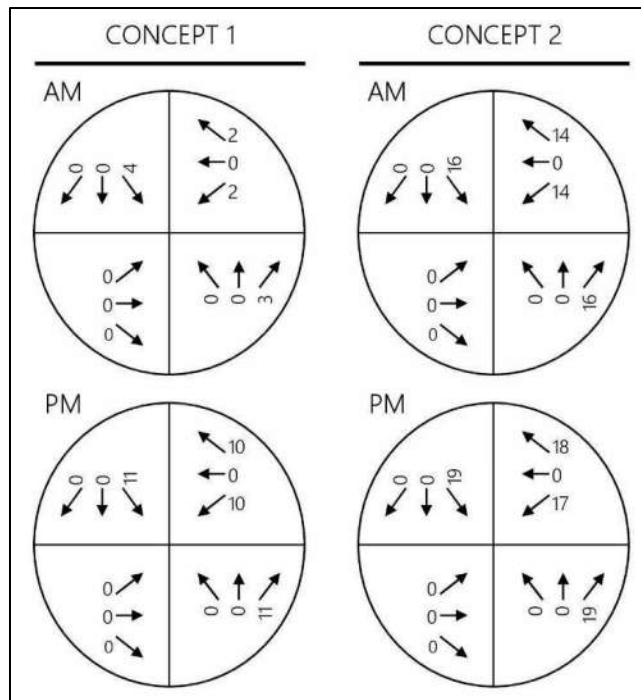

Figure 1: Potential Commercial Development Trip Assignment

Total Traffic – 2026 Buildout with BCPE

The potential commercial traffic for each concept was added to the year 2026 buildout forecast with the BSCE that was shown for Intersection 6 in Figure 6C of the Autumn Sunrise Subdivision TIS. The resulting volumes are shown in Figure 2.

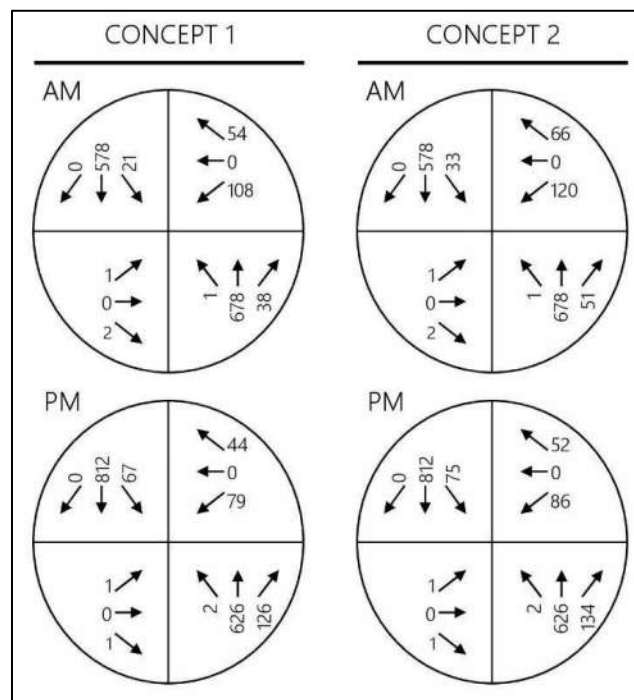

Figure 2: 2026 Buildout with BCPE and Potential Commercial Development



Warrant Analysis

Turn lane warrants and preliminary traffic signal warrants were examined for the study intersections where such treatments would be applicable.

Left-Turn Lane Warrants

SW Boones Ferry Road already has a center refuge lane that would be serve as a left-turn lane for the site access at that location; warrants were not evaluated.

Right-Turn Lane Warrants

Right-turn lane warrants were examined at the SW Boones Ferry Road site access under the Year 2026 buildout conditions. Table 9 of the TIS shows that northbound right-turn lane warrants are met at the proposed site access on SW Boones Ferry Road under the 2026 buildout scenario for both analysis periods. Given the 45-mph posted speed and higher traffic volumes, a northbound turn lane is recommended at this access.

Traffic Signal Warrants

Preliminary traffic signal warrants were examined at the site access intersection to determine whether the installation of a new traffic signal will be warranted with any of the potential commercial development concepts. The preliminary warrants are typically calculated based on the evening peak hour volumes assuming the daily demand is 10 times the evening peak hour. Because the volumes were higher in the morning under some of the scenarios, the warrants were also evaluated considering a daily demand that is 10 times the morning peak hour, which is a less likely scenario. The results are summarized in Table 2 for Year 2026 conditions with full buildout of the proposed development and the BCPE plus the two commercial concepts. A two-lane (left-through and right) approach for the site access is assumed. Detailed information on the warrant analysis is attached.

Table 2: Preliminary Traffic Signal Warrants at the Site Access on SW Boones Ferry Road with BCPE

Scenario	Warrant Met?	
	Based on Morning Peak	Based on Evening Peak
Year 2026 Conditions	No	No
Year 2026 Conditions + Commercial Concept 1	No	No
Year 2026 Conditions + Commercial Concept 2	No	No

As shown in Table 2, preliminary traffic signal warrants are not met with the commercial concepts.

Operations Analysis

An operations analysis was conducted for site access intersection with SW Boones Ferry Road per the signalized and unsignalized intersection analysis methodologies in the *Highway Capacity Manual* (HCM)³. Intersections are generally evaluated based on the average control delay experienced by vehicles and are assigned a grade according to their operation. The level of service (LOS) of an intersection can range from LOS A, which indicates very little, or no delay experienced by vehicles, to LOS F, which indicates a high degree of congestion and delay.

³ Transportation Research Board, *Highway Capacity Manual 6th Edition*, 2016.



The volume-to-capacity (v/c) ratio is a measure that compares the traffic volumes (demand) against the available capacity of an intersection.

Performance Standards

The following agency performance standards are applicable to the intersection:

- The **City of Tualatin** requires intersections to operate at a minimum D and E for signalized and unsignalized intersections, respectively.
- **Washington County** requires intersections to operate with a v/c ratio of 0.99 or less.

Delay & Capacity Analysis

The LOS, delay, and v/c results of the capacity analysis are shown in Table 3 for Year 2026 conditions with full buildout of the proposed development and the BCPE plus the two commercial concepts. A two-lane (left-through and right) approach for the site access is assumed. The northbound left is assumed to be striped as a two-way, left-turn lane for the unsignalized scenarios to allow for a two-stage left-turn movement from the site access. Detailed calculations are attached.

Table 3: Capacity Analysis Summary at the Site Access on SW Boones Ferry Road with BCPE

Intersection & Scenario	Morning Peak Hour			Evening Peak Hour		
	LOS	Delay (s)	V/C	LOS	Delay (s)	V/C
Year 2026 Conditions with BCPE*	D	25	0.40	D	27	0.31
Year 2026 Conditions + Commercial Concept 1	D	26	0.41	D	30	0.37
Year 2026 Conditions + Commercial Concept 2	D	28	0.47	D	32	0.41

* The results of the analysis without the concepts differs slightly from those presented in the TIS because the evaluation in this table does not account for the influence of upstream traffic signals.

As shown in Table 3, the intersection would meet performance standards with both commercial concepts with a two-lane approach for the site access.

Queuing

An analysis of queuing was conducted for the site access to identify how development of the commercial land could affect storage requirements for the site access intersection at SW Boones Ferry Road. The analysis was conducted based on the results of a SimTraffic simulation. Five (5) simulations were conducted, averaged, and the 95th percentile queue estimates were rounded up to the nearest 25 feet, or the approximate length of one vehicle to estimate the queue lengths.

Table 4 reports the 95th percentile queue estimates for the southbound left-turn, northbound left-turn, and the westbound left-through lanes. The northbound left is assumed to be striped as a two-way, left-turn lane to allow for a two-stage left-turn movement from the site access. However, SimTraffic cannot simulate this two-stage movement; therefore, the westbound left-turn queue estimates are conservatively long.



Table 4: Queue Lengths at the Site Access on SW Boones Ferry Road with BCPE

Intersection & Scenario	Morning Peak Hour			Evening Peak Hour		
	SB Left	NB Left	WB Left	SB Left	NB Left	WB Left
Year 2026 Conditions with BCPE	50 ft	<25 ft	150 ft	50 ft	<25 ft	100 ft
Year 2026 Conditions + Commercial Concept 2	50 ft	<25 ft	125 ft	50 ft	<25 ft	150 ft
Year 2026 Conditions + Commercial Concept 3	50 ft	<25 ft	200 ft	50 ft	<25 ft	175 ft

As shown in Table 4, under the most intensive concept, the maximum southbound storage requirement was estimated at:

- Two vehicles or 50 feet for the southbound left, which can easily be accommodated in the existing center refuge lane
- An occasional single vehicle or 25 feet for the northbound left, which can easily be accommodated in the existing center refuge lane
- Eight vehicles or 200 feet for the westbound left, which could be accommodated on the site access road without affecting the closest public street connection (“M” Street) to the east.

Conclusions

The conclusions below were developed as an exercise to understand how development of the commercially-zoned parcels abutting SW Boones Ferry Road could affect the configuration and traffic control at the site access (“H” Street) intersection. These parcels are not part of the subdivision; the specific timing and type of development that could occur on these parcels is unknown. Findings include:

- SW Boones Ferry Road already has a center refuge lane that would be serve as a left-turn lane for the site access at that location; warrants were not evaluated.
- The TIS recommends a northbound right-turn lane on SW Boones Ferry Road at the site access, no other conditions were evaluated.
- Preliminary traffic signal warrants would not be met with the commercial concepts and the two-lane (left-through and right) approach planned for the site access.
- The intersection at SW Boones Ferry Road would meet performance standards with both commercial concepts with a two-lane approach for the site access.
- Maximum queues were estimated at two vehicles or 50 feet for the southbound left, which can easily be accommodated in the existing center refuge lane
- Maximum queues were estimated at one vehicle or 25 feet for the northbound left, which can easily be accommodated in the existing center refuge lane
- Maximum queues were estimated at eight vehicles or 200 feet for a separate westbound left, which could be accommodated on the site access road without affecting the closest public street connection (“M” Street) to the east.



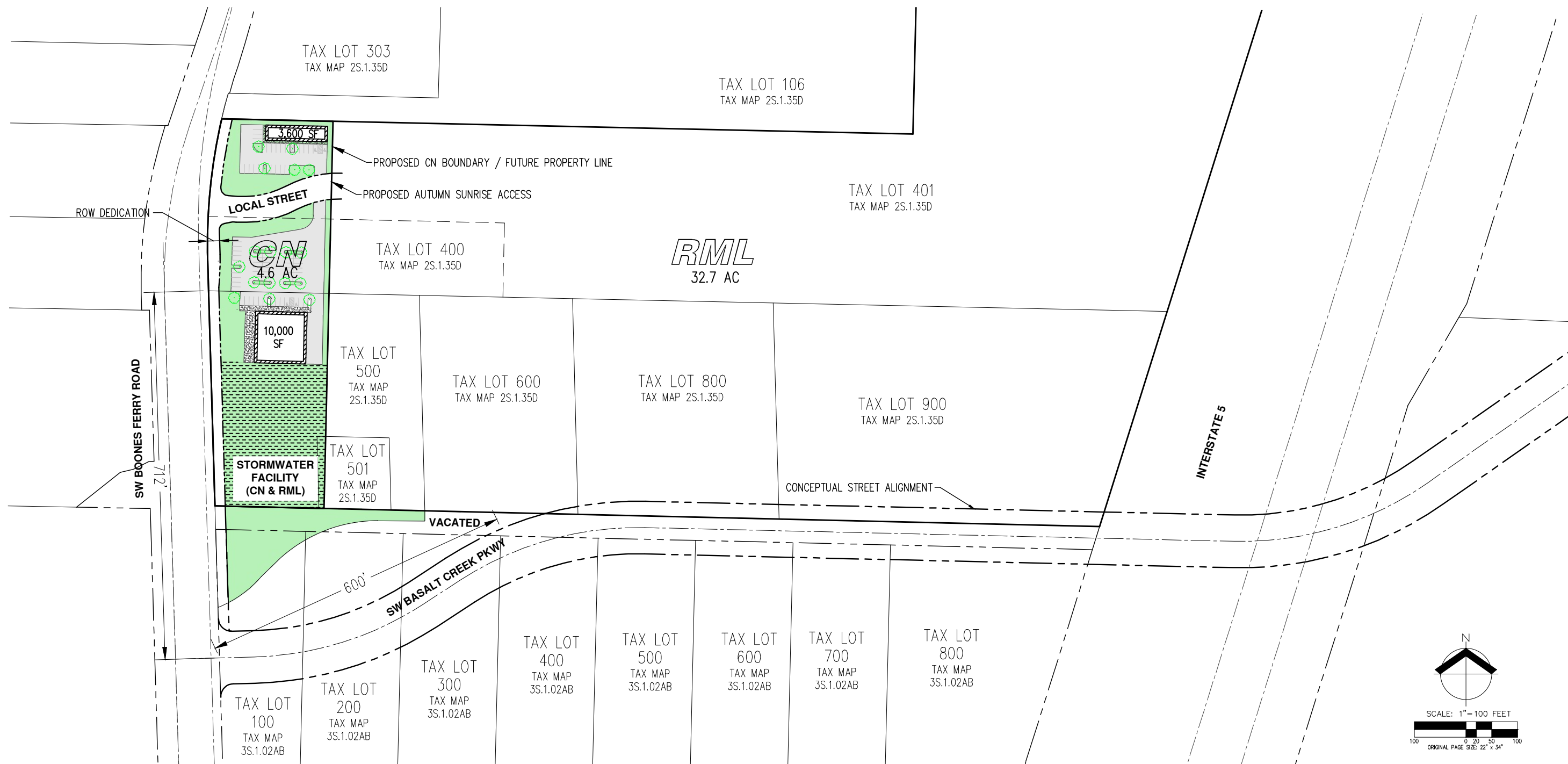

DATE: 08/30/2021 AKS JOB: 7454

AKS ENGINEERING & FORESTRY, LLC
 12965 SW HERMAN RD, STE 100
 TUALATIN, OR 97062
 503.563.6151
 WWW.AKS-ENG.COM



ENGINEERING • SURVEYING • NATURAL RESOURCES
 FORESTRY • PLANNING • LANDSCAPE ARCHITECTURE

CONCEPTUAL COMMERCIAL LAYOUT AUTUMN SUNRISE

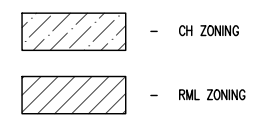
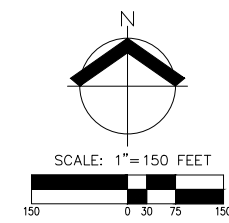
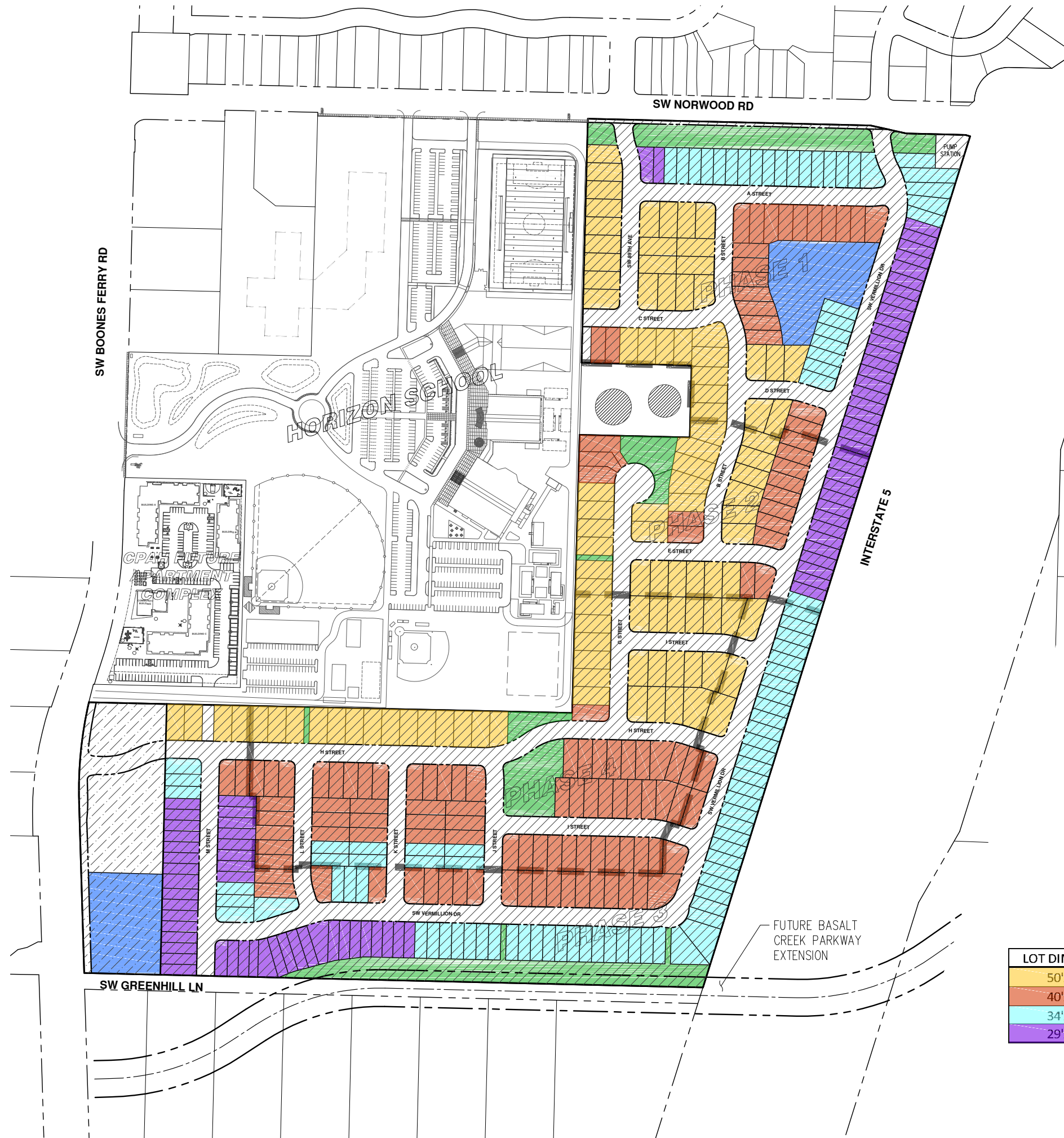

DENSITY CALCULATIONS

RML ZONE	SQ. FT.	ACRES
GROSS SITE AREA:	± 2,688,206	± 61.71
PUBLIC R.O.W. DEDICATION AREA:	± 629,282	± 14.45
CITY RESERVOR DEDICATION OPEN SPACE AREA:	± 12,879	± 0.30
PRIVATE STREET/ACCESS AREA:	± 5,718	± 0.13
STORMWATER FACILITY AREA:	± 155,691	± 3.57
COMMERCIAL AREA:	± 87,960	± 2.02
PUMP STATION DEDICATION AREA:	± 7,709	± 0.18
NET DEVELOPABLE:	± 1,788,967	± 41.07
AUTUMN SUNRISE SUBDIVISION		
MAXIMUM DENSITY (10 DU PER ACRE)	411 LOTS	
MINIMUM DENSITY (7 DU PER ACRE)	287 LOTS	
REQUIRED OPEN SPACE AREA (9% GROSS):	± 134,410 SQ. FT.	
OPEN SPACE PROVIDED:	± 168,629 SQ. FT.	
PLANNED DENSITY:	400 LOTS	
AVERAGE LOT AREA (ALL DU):	± 4,151 SQ. FT.	
AVERAGE LOT AREA FOR SF DETACHED DU	± 4,411 SQ. FT.	
AVERAGE LOT AREA FOR SF ATTACHED DU	± 3,109 SQ. FT.	
MAXIMUM LOT SIZE	± 7,731 SQ. FT.	
MINIMUM LOT SIZE	± 2,546 SQ. FT.	

LOT DIMENSION	HOUSE TYPE	PH-1	PH-2	PH-3	PH-4	TOTAL UNITS
50'x100'	Detached	35	25	7	35	102
40'x100'	Detached	21	15	25	60	121
34'x100'	Detached	29	1	59	8	97
29'x100'	Attached	24	14	42	-	80

TOTAL UNITS	109	55	133	103	400
-------------	-----	----	-----	-----	-----

Shopping Center	820	13.6 KSF	8	5	13	25	27	52	514
-----------------	-----	----------	---	---	----	----	----	----	-----

Day Care Center	565	5 KSF	29	26	55	26	30	56	119
Shopping Center	820	8.6 KSF	5	3	8	16	17	33	324
Total Primary Trips			34	29	63	42	47	89	443

Option 1 - Basic Shopping Center (13.6 KSF)

	AM Peak			Internal % Initial		Internal Initial		Internal Balanced		External	
	In	Out	Total	In	Out	In	Out	In	Out	In	Out
Residential	67	204	271	2%	1%	1	2	1	1	66	203
Commercial 1	8	5	13	17%	14%	1	1	1	1	7	4

Option 2 - Day Care (5 KSF) + Basic Shopping Center (8.6 KSF)

	AM Peak			Internal % Initial		Internal Initial		Internal Balanced		External	
	In	Out	Total	In	Out	In	Out	In	Out	In	Out
Residential	67	207	274	2%	1%	1	2	1	2	66	205
Commercial 1	34	29	63	17%	14%	6	4	2	1	32	28

Option 1 - Basic Shopping Center (13.6 KSF)

	PM Peak			Internal % Initial		Internal Initial		Internal Balanced		External	
	In	Out	Total	In	Out	In	Out	In	Out	In	Out
Residential	225	133	358	46%	42%	104	56	7	3	218	130
Commercial 1	25	27	52	10%	26%	3	7	3	7	22	20

Option 2 - Day Care (5 KSF) + Basic Shopping Center (8.6 KSF)

	PM Peak			Internal % Initial		Internal Initial		Internal Balanced		External	
	In	Out	Total	In	Out	In	Out	In	Out	In	Out
Residential	225	133	358	46%	42%	104	56	12	4	213	129
Commercial 1	42	47	89	10%	26%	4	12	4	12	38	35



TRIP GENERATION CALCULATIONS

Land Use: Day Care Center
Land Use Code: 565
Setting/Location: General Urban/Suburban
Variable: 1,000 Sq Ft Gross Floor Area
Variable Value: 5

AM PEAK HOUR

Trip Rate: 11.00

	Enter	Exit	Total
Directional Distribution	53%	47%	
Trip Ends	29	26	55

PM PEAK HOUR

Trip Rate: 11.12

	Enter	Exit	Total
Directional Distribution	47%	53%	
Trip Ends	26	30	56

WEEKDAY

Trip Rate: 47.62

	Enter	Exit	Total
Directional Distribution	50%	50%	
Trip Ends	119	119	238

SATURDAY

Trip Rate: 6.22

	Enter	Exit	Total
Directional Distribution	50%	50%	
Trip Ends	16	16	32



TRIP GENERATION CALCULATIONS

Land Use: Shopping Center
Land Use Code: 820
Setting/Location: General Urban/Suburban
Variable: 1,000 Sq. Ft. GFA
Variable Value: 13.6

AM PEAK HOUR

Trip Rate: 0.94

	Enter	Exit	Total
Directional Distribution	62%	38%	
Trip Ends	8	5	13

PM PEAK HOUR

Trip Rate: 3.81

	Enter	Exit	Total
Directional Distribution	48%	52%	
Trip Ends	25	27	52

WEEKDAY

Trip Rate: 37.75

	Enter	Exit	Total
Directional Distribution	50%	50%	
Trip Ends	257	257	514

SATURDAY

Trip Rate: 46.12

	Enter	Exit	Total
Directional Distribution	50%	50%	
Trip Ends	314	314	628



TRIP GENERATION CALCULATIONS

Land Use: Shopping Center
Land Use Code: 820
Setting/Location: General Urban/Suburban
Variable: 1,000 Sq. Ft. GFA
Variable Value: 8.6

AM PEAK HOUR

Trip Rate: 0.94

	Enter	Exit	Total
Directional Distribution	62%	38%	
Trip Ends	5	3	8

PM PEAK HOUR

Trip Rate: 3.81

	Enter	Exit	Total
Directional Distribution	48%	52%	
Trip Ends	16	17	33

WEEKDAY

Trip Rate: 37.75

	Enter	Exit	Total
Directional Distribution	50%	50%	
Trip Ends	162	162	324

SATURDAY

Trip Rate: 46.12

	Enter	Exit	Total
Directional Distribution	50%	50%	
Trip Ends	198	198	396

Preliminary Traffic Signal Warrant Summary



Intersection

Warrant Met?

Site Access at SW Boones Ferry Road

Year 2026 Conditions (Based on AM) w/ 2-lane Exit	No
Year 2026 Conditions (Based on PM) w/ 2-lane Exit	No
Year 2026 Conditions (Based on AM) + Basic Shopping Center (13.6 KSF) w/ 2-lane Exit	No
Year 2026 Conditions (Based on PM) + Basic Shopping Center (13.6 KSF) w/ 2-lane Exit	No
Year 2026 Conditions (Based on AM) + Day Care (5 KSF) + Basic Shopping Center (8.6 KSF) w/ 2-lane Exit	No
Year 2026 Conditions (Based on PM) + Day Care (5 KSF) + Basic Shopping Center (8.6 KSF) w/ 2-lane Exit	No



Preliminary Traffic Signal Warrant Analysis

Project: 21029 - Autumn Sunrise
 Date: 9/20/2021
 Scenario: Year 2026 Conditions (Based on AM) w/ 2-lane Exit

Major Street:	SW Boones Ferry Road	Minor Street:	Site Access	
Number of Lanes:	1	Number of Lanes:	1	
AM Peak Hour Volumes:	1302	AM Peak Hour Volumes:	154	Total
			58	Rights
			100%	RT Discount

Warrant Used:

 X 100 percent of standard warrants used
 70 percent of standard warrants used due to 85th percentile speed in excess of 40 mph or isolated community with population less than 10,000.

Number of Lanes for Moving Traffic on Each Approach:		ADT on Major St. (total of both approaches)		ADT on Minor St. (higher-volume approach)	
<u>Major St.</u>	<u>Minor St.</u>	<u>Warrants</u>	<u>Warrants</u>	<u>Warrants</u>	<u>Warrants</u>
<u>WARRANT 1, CONDITION A</u>					
1	1	8,850	6,200	2,650	1,850
2 or more	1	10,600	7,400	2,650	1,850
2 or more	2 or more	10,600	7,400	3,550	2,500
1	2 or more	8,850	6,200	3,550	2,500
<u>WARRANT 1, CONDITION B</u>					
1	1	13,300	9,300	1,350	950
2 or more	1	15,900	11,100	1,350	950
2 or more	2 or more	15,900	11,100	1,750	1,250
1	2 or more	13,300	9,300	1,750	1,250

Note: ADT volumes assume 8th highest hour is 5.6% of the daily volume

	Approach Volumes	Minimum Volumes	Is Signal Warrant Met?
<i>Warrant 1</i>			
<i>Condition A: Minimum Vehicular Volume</i>			
Major Street	13,020	8,850	
Minor Street*	960	2,650	No
<i>Condition B: Interruption of Continuous Traffic</i>			
Major Street	13,020	13,300	
Minor Street*	960	1,350	No
<i>Combination Warrant</i>			
Major Street	13,020	10,640	
Minor Street*	960	2,120	No

* Minor street right-turning traffic volumes reduced by 100%.



Preliminary Traffic Signal Warrant Analysis

Project: 21029 - Autumn Sunrise
 Date: 9/20/2021
 Scenario: Year 2026 Conditions (Based on PM) w/ 2-lane Exit

Major Street:	SW Boones Ferry Road	Minor Street:	Site Access	
Number of Lanes:	1	Number of Lanes:	1	
PM Peak Hour Volumes:	1596	PM Peak Hour Volumes:	100	Total
			38	Rights
			100%	RT Discount

Warrant Used:

 X 100 percent of standard warrants used
 70 percent of standard warrants used due to 85th percentile speed in excess of 40 mph or isolated community with population less than 10,000.

Number of Lanes for Moving Traffic on Each Approach:		ADT on Major St. (total of both approaches)		ADT on Minor St. (higher-volume approach)	
<u>Major St.</u>	<u>Minor St.</u>	<u>Warrants</u>	<u>Warrants</u>	<u>Warrants</u>	<u>Warrants</u>
<u>WARRANT 1, CONDITION A</u>					
1	1	8,850	6,200	2,650	1,850
2 or more	1	10,600	7,400	2,650	1,850
2 or more	2 or more	10,600	7,400	3,550	2,500
1	2 or more	8,850	6,200	3,550	2,500
<u>WARRANT 1, CONDITION B</u>					
1	1	13,300	9,300	1,350	950
2 or more	1	15,900	11,100	1,350	950
2 or more	2 or more	15,900	11,100	1,750	1,250
1	2 or more	13,300	9,300	1,750	1,250

Note: ADT volumes assume 8th highest hour is 5.6% of the daily volume

	Approach Volumes	Minimum Volumes	Is Signal Warrant Met?
<i>Warrant 1</i>			
<i>Condition A: Minimum Vehicular Volume</i>			
Major Street	15,960	8,850	
Minor Street*	620	2,650	No
<i>Condition B: Interruption of Continuous Traffic</i>			
Major Street	15,960	13,300	
Minor Street*	620	1,350	No
<i>Combination Warrant</i>			
Major Street	15,960	10,640	
Minor Street*	620	2,120	No

* Minor street right-turning traffic volumes reduced by 100%.



Preliminary Traffic Signal Warrant Analysis

Project: 21029 - Autumn Sunrise
 Date: 9/20/2021
 Scenario: Year 2026 Conditions (Based on AM) + Basic Shopping Center (13.6 KSF) w/ 2-lane Exit

Major Street:	SW Boones Ferry Road	Minor Street:	Site Access	
Number of Lanes:	1	Number of Lanes:	1	
PM Peak Hour Volumes:	1309	PM Peak Hour Volumes:	158	Total
			60	Rights
			100%	RT Discount

Warrant Used:

 X 100 percent of standard warrants used
 70 percent of standard warrants used due to 85th percentile speed in excess of 40 mph or isolated community with population less than 10,000.

Number of Lanes for Moving Traffic on Each Approach:		ADT on Major St. (total of both approaches)		ADT on Minor St. (higher-volume approach)	
<u>Major St.</u>	<u>Minor St.</u>	<u>Warrants</u>	<u>Warrants</u>	<u>Warrants</u>	<u>Warrants</u>
<u>WARRANT 1, CONDITION A</u>					
1	1	8,850	6,200	2,650	1,850
2 or more	1	10,600	7,400	2,650	1,850
2 or more	2 or more	10,600	7,400	3,550	2,500
1	2 or more	8,850	6,200	3,550	2,500
<u>WARRANT 1, CONDITION B</u>					
1	1	13,300	9,300	1,350	950
2 or more	1	15,900	11,100	1,350	950
2 or more	2 or more	15,900	11,100	1,750	1,250
1	2 or more	13,300	9,300	1,750	1,250

Note: ADT volumes assume 8th highest hour is 5.6% of the daily volume

	Approach Volumes	Minimum Volumes	Is Signal Warrant Met?
<i>Warrant 1</i>			
<i>Condition A: Minimum Vehicular Volume</i>			
Major Street	13,090	8,850	
Minor Street*	980	2,650	No
<i>Condition B: Interruption of Continuous Traffic</i>			
Major Street	13,090	13,300	
Minor Street*	980	1,350	No
<i>Combination Warrant</i>			
Major Street	13,090	10,640	
Minor Street*	980	2,120	No

* Minor street right-turning traffic volumes reduced by 100%.



Preliminary Traffic Signal Warrant Analysis

Project: 21029 - Autumn Sunrise
 Date: 9/20/2021
 Scenario: Year 2026 Conditions (Based on PM) + Basic Shopping Center (13.6 KSF) w/ 2-lane Exit

Major Street:	SW Boones Ferry Road	Minor Street:	Site Access	
Number of Lanes:	1	Number of Lanes:	1	
PM Peak Hour Volumes:	1618	PM Peak Hour Volumes:	120	Total Rights RT Discount
			48	
			100%	

Warrant Used:

 X 100 percent of standard warrants used
 70 percent of standard warrants used due to 85th percentile speed in excess of 40 mph or isolated community with population less than 10,000.

Number of Lanes for Moving Traffic on Each Approach:		ADT on Major St. (total of both approaches)		ADT on Minor St. (higher-volume approach)	
<u>Major St.</u>	<u>Minor St.</u>	<u>Warrants</u>	<u>Warrants</u>	<u>Warrants</u>	<u>Warrants</u>
<u>WARRANT 1, CONDITION A</u>					
1	1	8,850	6,200	2,650	1,850
2 or more	1	10,600	7,400	2,650	1,850
2 or more	2 or more	10,600	7,400	3,550	2,500
1	2 or more	8,850	6,200	3,550	2,500
<u>WARRANT 1, CONDITION B</u>					
1	1	13,300	9,300	1,350	950
2 or more	1	15,900	11,100	1,350	950
2 or more	2 or more	15,900	11,100	1,750	1,250
1	2 or more	13,300	9,300	1,750	1,250

Note: ADT volumes assume 8th highest hour is 5.6% of the daily volume

	Approach Volumes	Minimum Volumes	Is Signal Warrant Met?
<i>Warrant 1</i>			
<i>Condition A: Minimum Vehicular Volume</i>			
Major Street	16,180	8,850	
Minor Street*	720	2,650	No
<i>Condition B: Interruption of Continuous Traffic</i>			
Major Street	16,180	13,300	
Minor Street*	720	1,350	No
<i>Combination Warrant</i>			
Major Street	16,180	10,640	
Minor Street*	720	2,120	No

* Minor street right-turning traffic volumes reduced by 100%.



Preliminary Traffic Signal Warrant Analysis

Project: 21029 - Autumn Sunrise
 Date: 9/20/2021
 Scenario: Year 2026 Conditions (Based on AM) + Day Care (5 KSF) + Basic Shopping Center (8.6 KSF) w/ 2-lane

Major Street:	SW Boones Ferry Road	Minor Street:	Site Access	
Number of Lanes:	1	Number of Lanes:	1	
PM Peak Hour Volumes:	1334	PM Peak Hour Volumes:	182	Total
			72	Rights
			100%	RT Discount

Warrant Used:

 X 100 percent of standard warrants used
 70 percent of standard warrants used due to 85th percentile speed in excess of 40 mph or isolated community with population less than 10,000.

Number of Lanes for Moving Traffic on Each Approach:		ADT on Major St. (total of both approaches)		ADT on Minor St. (higher-volume approach)	
<u>Major St.</u>	<u>Minor St.</u>	<u>Warrants</u>	<u>Warrants</u>	<u>Warrants</u>	<u>Warrants</u>
<u>WARRANT 1, CONDITION A</u>					
1	1	8,850	6,200	2,650	1,850
2 or more	1	10,600	7,400	2,650	1,850
2 or more	2 or more	10,600	7,400	3,550	2,500
1	2 or more	8,850	6,200	3,550	2,500
<u>WARRANT 1, CONDITION B</u>					
1	1	13,300	9,300	1,350	950
2 or more	1	15,900	11,100	1,350	950
2 or more	2 or more	15,900	11,100	1,750	1,250
1	2 or more	13,300	9,300	1,750	1,250

Note: ADT volumes assume 8th highest hour is 5.6% of the daily volume

	Approach Volumes	Minimum Volumes	Is Signal Warrant Met?
<i>Warrant 1</i>			
<i>Condition A: Minimum Vehicular Volume</i>			
Major Street	13,340	8,850	
Minor Street*	1,100	2,650	No
<i>Condition B: Interruption of Continuous Traffic</i>			
Major Street	13,340	13,300	
Minor Street*	1,100	1,350	No
<i>Combination Warrant</i>			
Major Street	13,340	10,640	
Minor Street*	1,100	2,120	No

* Minor street right-turning traffic volumes reduced by 100%.



Preliminary Traffic Signal Warrant Analysis

Project: 21029 - Autumn Sunrise
 Date: 9/20/2021
 Scenario: Year 2026 Conditions (Based on PM) + Day Care (5 KSF) + Basic Shopping Center (8.6 KSF) w/ 2-lane

Major Street:	SW Boones Ferry Road	Minor Street:	Site Access	
Number of Lanes:	1	Number of Lanes:	1	
PM Peak Hour Volumes:	1634	PM Peak Hour Volumes:	135	Total
			56	Rights
			100%	RT Discount

Warrant Used:

 X 100 percent of standard warrants used
 70 percent of standard warrants used due to 85th percentile speed in excess
 of 40 mph or isolated community with population less than 10,000.

Number of Lanes for Moving Traffic on Each Approach:		ADT on Major St. (total of both approaches)		ADT on Minor St. (higher-volume approach)	
<u>Major St.</u>	<u>Minor St.</u>	<u>Warrants</u>	<u>Warrants</u>	<u>Warrants</u>	<u>Warrants</u>
<u>WARRANT 1, CONDITION A</u>					
1	1	8,850	6,200	2,650	1,850
2 or more	1	10,600	7,400	2,650	1,850
2 or more	2 or more	10,600	7,400	3,550	2,500
1	2 or more	8,850	6,200	3,550	2,500
<u>WARRANT 1, CONDITION B</u>					
1	1	13,300	9,300	1,350	950
2 or more	1	15,900	11,100	1,350	950
2 or more	2 or more	15,900	11,100	1,750	1,250
1	2 or more	13,300	9,300	1,750	1,250

Note: ADT volumes assume 8th highest hour is 5.6% of the daily volume

	Approach Volumes	Minimum Volumes	Is Signal Warrant Met?
<i>Warrant 1</i>			
<i>Condition A: Minimum Vehicular Volume</i>			
Major Street	16,340	8,850	
Minor Street*	790	2,650	No
<i>Condition B: Interruption of Continuous Traffic</i>			
Major Street	16,340	13,300	
Minor Street*	790	1,350	No
<i>Combination Warrant</i>			
Major Street	16,340	10,640	
Minor Street*	790	2,120	No

* Minor street right-turning traffic volumes reduced by 100%.



Project: 21029 - Autumn Sunrise
Intersection: SW Boones Ferry Road/Site Access - Northbound
Date: 6/30/2021
Scenario: 2026 Buildout - Phases 1-4

Speed? 45 mph 72 kmh

AM Peak Hour		PM Peak Hour	
Right-Turn Volume	32	Right-Turn Volume	104
Approaching DHV	709	Approaching DHV	725
Lane Needed?	Yes	Lane Needed?	Yes

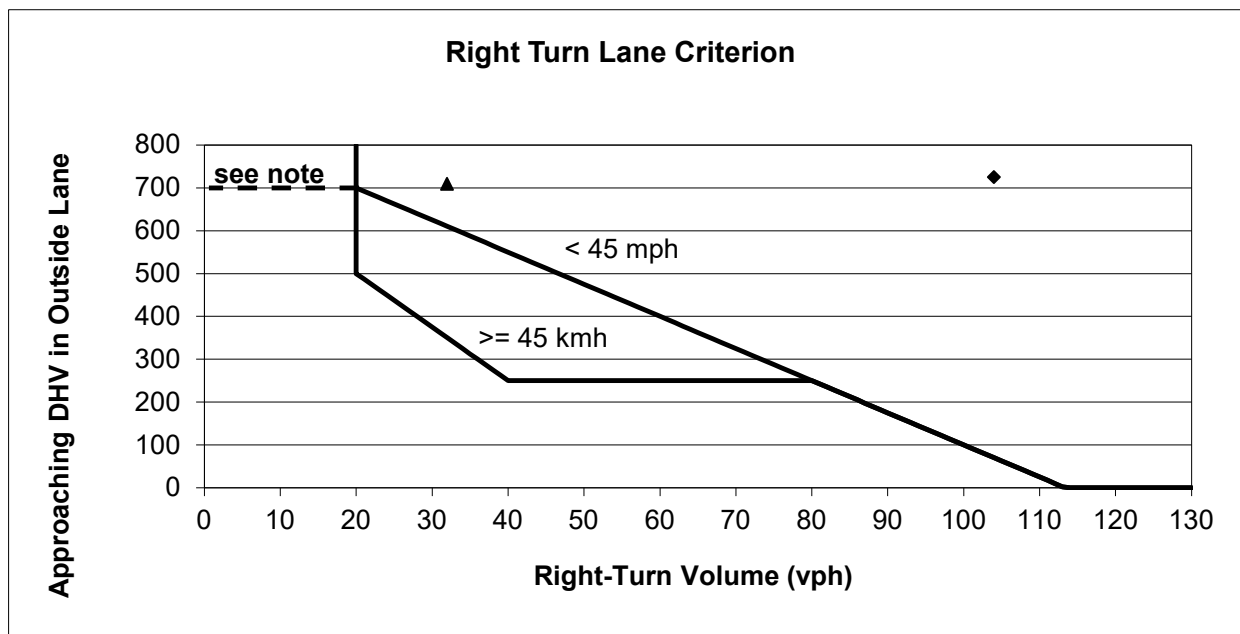

Note: If there is no right turn lane, a shoulder needs to be provided.
If this intersection is in a rural area and is a connection to a public street, a right turn lane is needed.

HCM 6th TWSC
6: SW Boones Ferry Road & Site Access

09/20/2021

Intersection												
Int Delay, s/veh	2.5											
Movement	EBL	EBT	EBR	WBL	WBT	WBR	NBL	NBT	NBR	SBL	SBT	SBR
Lane Configurations		↕↔			↕	↕	↕	↕	↕	↕	↕	↕
Traffic Vol, veh/h	1	0	2	106	0	52	1	678	35	17	578	0
Future Vol, veh/h	1	0	2	106	0	52	1	678	35	17	578	0
Conflicting Peds, #/hr	0	0	0	4	0	4	0	0	4	4	0	0
Sign Control	Stop	Stop	Stop	Stop	Stop	Stop	Free	Free	Free	Free	Free	Free
RT Channelized	-	-	None	-	-	None	-	-	None	-	-	None
Storage Length	-	-	-	-	-	150	150	-	150	150	-	-
Veh in Median Storage, #	-	0	-	-	2	-	-	0	-	-	0	-
Grade, %	-	0	-	-	0	-	-	0	-	-	0	-
Peak Hour Factor	90	90	90	90	90	90	90	90	90	90	90	90
Heavy Vehicles, %	2	2	2	0	2	0	2	6	6	5	5	2
Mvmt Flow	1	0	2	118	0	58	1	753	39	19	642	0

Major/Minor	Minor2		Minor1		Major1		Major2					
Conflicting Flow All	1488	1478	646	1444	1439	761	642	0	0	796	0	0
Stage 1	680	680	-	759	759	-	-	-	-	-	-	-
Stage 2	808	798	-	685	680	-	-	-	-	-	-	-
Critical Hdwy	7.12	6.52	6.22	7.1	6.52	6.2	4.12	-	-	4.15	-	-
Critical Hdwy Stg 1	6.12	5.52	-	6.1	5.52	-	-	-	-	-	-	-
Critical Hdwy Stg 2	6.12	5.52	-	6.1	5.52	-	-	-	-	-	-	-
Follow-up Hdwy	3.518	4.018	3.318	3.5	4.018	3.3	2.218	-	-	2.245	-	-
Pot Cap-1 Maneuver	102	126	472	~111	133	409	943	-	-	813	-	-
Stage 1	441	451	-	402	415	-	-	-	-	-	-	-
Stage 2	375	398	-	441	451	-	-	-	-	-	-	-
Platoon blocked, %								-	-	-	-	-
Mov Cap-1 Maneuver	85	122	470	~108	129	406	943	-	-	810	-	-
Mov Cap-2 Maneuver	85	122	-	295	310	-	-	-	-	-	-	-
Stage 1	441	441	-	400	413	-	-	-	-	-	-	-
Stage 2	320	396	-	427	441	-	-	-	-	-	-	-

Approach	EB		WB		NB		SB	
HCM Control Delay, s	24.6		21.9		0		0.3	
HCM LOS	C		C					

Minor Lane/Major Mvmt	NBL	NBT	NBR	EBLn1	WBLn1	WBLn2	SBL	SBT	SBR
Capacity (veh/h)	943	-	-	187	295	406	810	-	-
HCM Lane V/C Ratio	0.001	-	-	0.018	0.399	0.142	0.023	-	-
HCM Control Delay (s)	8.8	-	-	24.6	25.1	15.3	9.6	-	-
HCM Lane LOS	A	-	-	C	D	C	A	-	-
HCM 95th %tile Q(veh)	0	-	-	0.1	1.8	0.5	0.1	-	-

Notes
 ~: Volume exceeds capacity \$: Delay exceeds 300s +: Computation Not Defined *: All major volume in platoon

HCM 6th TWSC
6: SW Boones Ferry Road & Site Access

09/20/2021

Intersection												
Int Delay, s/veh	1.7											
Movement	EBL	EBT	EBR	WBL	WBT	WBR	NBL	NBT	NBR	SBL	SBT	SBR
Lane Configurations		↔			↔	↔	↔	↑	↔	↔	↔	↔
Traffic Vol, veh/h	1	0	1	69	0	34	2	626	115	56	812	0
Future Vol, veh/h	1	0	1	69	0	34	2	626	115	56	812	0
Conflicting Peds, #/hr	0	0	0	2	0	2	0	0	2	2	0	0
Sign Control	Stop	Stop	Stop	Stop	Stop	Stop	Free	Free	Free	Free	Free	Free
RT Channelized	-	-	None	-	-	None	-	-	None	-	-	None
Storage Length	-	-	-	-	-	150	150	-	150	150	-	-
Veh in Median Storage, #	-	0	-	-	2	-	-	0	-	-	0	-
Grade, %	-	0	-	-	0	-	-	0	-	-	0	-
Peak Hour Factor	92	92	92	95	92	95	92	95	95	95	95	92
Heavy Vehicles, %	2	2	2	0	2	0	2	3	3	2	2	2
Mvmt Flow	1	0	1	73	0	36	2	659	121	59	855	0

Major/Minor	Minor2		Minor1		Major1		Major2					
Conflicting Flow All	1717	1759	857	1641	1638	663	855	0	0	782	0	0
Stage 1	973	973	-	665	665	-	-	-	-	-	-	-
Stage 2	744	786	-	976	973	-	-	-	-	-	-	-
Critical Hdwy	7.12	6.52	6.22	7.1	6.52	6.2	4.12	-	-	4.12	-	-
Critical Hdwy Stg 1	6.12	5.52	-	6.1	5.52	-	-	-	-	-	-	-
Critical Hdwy Stg 2	6.12	5.52	-	6.1	5.52	-	-	-	-	-	-	-
Follow-up Hdwy	3.518	4.018	3.318	3.5	4.018	3.3	2.218	-	-	2.218	-	-
Pot Cap-1 Maneuver	71	85	357	81	100	465	785	-	-	836	-	-
Stage 1	303	330	-	453	458	-	-	-	-	-	-	-
Stage 2	407	403	-	305	330	-	-	-	-	-	-	-
Platoon blocked, %								-	-	-	-	-
Mov Cap-1 Maneuver	62	79	356	76	92	463	785	-	-	834	-	-
Mov Cap-2 Maneuver	62	79	-	235	254	-	-	-	-	-	-	-
Stage 1	302	307	-	451	456	-	-	-	-	-	-	-
Stage 2	374	401	-	282	307	-	-	-	-	-	-	-

Approach	EB		WB		NB		SB	
HCM Control Delay, s	39.7		22.5		0		0.6	
HCM LOS	E		C					

Minor Lane/Major Mvmt	NBL	NBT	NBR	EBLn1	WBLn1	WBLn2	SBL	SBT	SBR
Capacity (veh/h)	785	-	-	106	235	463	834	-	-
HCM Lane V/C Ratio	0.003	-	-	0.021	0.309	0.077	0.071	-	-
HCM Control Delay (s)	9.6	-	-	39.7	27	13.4	9.6	-	-
HCM Lane LOS	A	-	-	E	D	B	A	-	-
HCM 95th %tile Q(veh)	0	-	-	0.1	1.3	0.2	0.2	-	-

HCM 6th TWSC
6: SW Boones Ferry Road & Site Access

09/20/2021

Intersection												
Int Delay, s/veh	2.6											
Movement	EBL	EBT	EBR	WBL	WBT	WBR	NBL	NBT	NBR	SBL	SBT	SBR
Lane Configurations		↕↔			↕	↕	↕	↕	↕	↕	↕	
Traffic Vol, veh/h	1	0	2	108	0	54	1	678	38	21	578	0
Future Vol, veh/h	1	0	2	108	0	54	1	678	38	21	578	0
Conflicting Peds, #/hr	0	0	0	4	0	4	0	0	4	4	0	0
Sign Control	Stop	Stop	Stop	Stop	Stop	Stop	Free	Free	Free	Free	Free	Free
RT Channelized	-	-	None	-	-	None	-	-	None	-	-	None
Storage Length	-	-	-	-	-	150	150	-	150	150	-	-
Veh in Median Storage, #	-	0	-	-	2	-	-	0	-	-	0	-
Grade, %	-	0	-	-	0	-	-	0	-	-	0	-
Peak Hour Factor	90	90	90	90	90	90	90	90	90	90	90	90
Heavy Vehicles, %	2	2	2	0	2	0	2	6	6	5	5	2
Mvmt Flow	1	0	2	120	0	60	1	753	42	23	642	0

Major/Minor	Minor2		Minor1		Major1		Major2					
Conflicting Flow All	1498	1489	646	1452	1447	761	642	0	0	799	0	0
Stage 1	688	688	-	759	759	-	-	-	-	-	-	-
Stage 2	810	801	-	693	688	-	-	-	-	-	-	-
Critical Hdwy	7.12	6.52	6.22	7.1	6.52	6.2	4.12	-	-	4.15	-	-
Critical Hdwy Stg 1	6.12	5.52	-	6.1	5.52	-	-	-	-	-	-	-
Critical Hdwy Stg 2	6.12	5.52	-	6.1	5.52	-	-	-	-	-	-	-
Follow-up Hdwy	3.518	4.018	3.318	3.5	4.018	3.3	2.218	-	-	2.245	-	-
Pot Cap-1 Maneuver	101	124	472	~110	131	409	943	-	-	811	-	-
Stage 1	436	447	-	402	415	-	-	-	-	-	-	-
Stage 2	374	397	-	437	447	-	-	-	-	-	-	-
Platoon blocked, %								-	-	-	-	-
Mov Cap-1 Maneuver	84	120	470	~106	127	406	943	-	-	808	-	-
Mov Cap-2 Maneuver	84	120	-	293	308	-	-	-	-	-	-	-
Stage 1	436	434	-	400	413	-	-	-	-	-	-	-
Stage 2	317	395	-	421	434	-	-	-	-	-	-	-

Approach	EB		WB		NB		SB	
HCM Control Delay, s	24.7		22.2		0		0.3	
HCM LOS	C		C					

Minor Lane/Major Mvmt	NBL	NBT	NBR	EBLn1	WBLn1	WBLn2	SBL	SBT	SBR
Capacity (veh/h)	943	-	-	186	293	406	808	-	-
HCM Lane V/C Ratio	0.001	-	-	0.018	0.41	0.148	0.029	-	-
HCM Control Delay (s)	8.8	-	-	24.7	25.6	15.4	9.6	-	-
HCM Lane LOS	A	-	-	C	D	C	A	-	-
HCM 95th %tile Q(veh)	0	-	-	0.1	1.9	0.5	0.1	-	-

Notes
 ~: Volume exceeds capacity \$: Delay exceeds 300s +: Computation Not Defined *: All major volume in platoon

HCM 6th TWSC
6: SW Boones Ferry Road & Site Access

09/20/2021

Intersection												
Int Delay, s/veh	2.1											
Movement	EBL	EBT	EBR	WBL	WBT	WBR	NBL	NBT	NBR	SBL	SBT	SBR
Lane Configurations		↕			↕	↕	↕	↕	↕	↕	↕	
Traffic Vol, veh/h	1	0	1	79	0	44	2	626	126	67	812	0
Future Vol, veh/h	1	0	1	79	0	44	2	626	126	67	812	0
Conflicting Peds, #/hr	0	0	0	2	0	2	0	0	2	2	0	0
Sign Control	Stop	Stop	Stop	Stop	Stop	Stop	Free	Free	Free	Free	Free	Free
RT Channelized	-	-	None	-	-	None	-	-	None	-	-	None
Storage Length	-	-	-	-	-	150	150	-	150	150	-	-
Veh in Median Storage, #	-	0	-	-	2	-	-	0	-	-	0	-
Grade, %	-	0	-	-	0	-	-	0	-	-	0	-
Peak Hour Factor	92	92	92	95	92	95	92	95	95	95	95	92
Heavy Vehicles, %	2	2	2	0	2	0	2	3	3	2	2	2
Mvmt Flow	1	0	1	83	0	46	2	659	133	71	855	0

Major/Minor	Minor2		Minor1		Major1		Major2					
Conflicting Flow All	1752	1795	857	1665	1662	663	855	0	0	794	0	0
Stage 1	997	997	-	665	665	-	-	-	-	-	-	-
Stage 2	755	798	-	1000	997	-	-	-	-	-	-	-
Critical Hdwy	7.12	6.52	6.22	7.1	6.52	6.2	4.12	-	-	4.12	-	-
Critical Hdwy Stg 1	6.12	5.52	-	6.1	5.52	-	-	-	-	-	-	-
Critical Hdwy Stg 2	6.12	5.52	-	6.1	5.52	-	-	-	-	-	-	-
Follow-up Hdwy	3.518	4.018	3.318	3.5	4.018	3.3	2.218	-	-	2.218	-	-
Pot Cap-1 Maneuver	67	80	357	~78	97	465	785	-	-	827	-	-
Stage 1	294	322	-	453	458	-	-	-	-	-	-	-
Stage 2	401	398	-	295	322	-	-	-	-	-	-	-
Platoon blocked, %								-	-	-	-	-
Mov Cap-1 Maneuver	56	73	356	~72	88	463	785	-	-	825	-	-
Mov Cap-2 Maneuver	56	73	-	225	245	-	-	-	-	-	-	-
Stage 1	293	294	-	451	456	-	-	-	-	-	-	-
Stage 2	359	396	-	268	294	-	-	-	-	-	-	-

Approach	EB		WB		NB		SB	
HCM Control Delay, s	43		24.2		0		0.7	
HCM LOS	E		C					

Minor Lane/Major Mvmt	NBL	NBT	NBR	EBLn1	WBLn1	WBLn2	SBL	SBT	SBR
Capacity (veh/h)	785	-	-	97	225	463	825	-	-
HCM Lane V/C Ratio	0.003	-	-	0.022	0.37	0.1	0.085	-	-
HCM Control Delay (s)	9.6	-	-	43	30.1	13.6	9.8	-	-
HCM Lane LOS	A	-	-	E	D	B	A	-	-
HCM 95th %tile Q(veh)	0	-	-	0.1	1.6	0.3	0.3	-	-

Notes
 ~: Volume exceeds capacity \$: Delay exceeds 300s +: Computation Not Defined *: All major volume in platoon

HCM 6th TWSC
6: SW Boones Ferry Road & Site Access

09/20/2021

Intersection												
Int Delay, s/veh	3.2											
Movement	EBL	EBT	EBR	WBL	WBT	WBR	NBL	NBT	NBR	SBL	SBT	SBR
Lane Configurations		↕↔			↕	↕	↕	↕	↕	↕	↕	↕
Traffic Vol, veh/h	1	0	2	120	0	66	1	678	51	33	578	0
Future Vol, veh/h	1	0	2	120	0	66	1	678	51	33	578	0
Conflicting Peds, #/hr	0	0	0	4	0	4	0	0	4	4	0	0
Sign Control	Stop	Stop	Stop	Stop	Stop	Stop	Free	Free	Free	Free	Free	Free
RT Channelized	-	-	None	-	-	None	-	-	None	-	-	None
Storage Length	-	-	-	-	-	150	150	-	150	150	-	-
Veh in Median Storage, #	-	0	-	-	2	-	-	0	-	-	0	-
Grade, %	-	0	-	-	0	-	-	0	-	-	0	-
Peak Hour Factor	90	90	90	90	90	90	90	90	90	90	90	90
Heavy Vehicles, %	2	2	2	0	2	0	2	6	6	5	5	2
Mvmt Flow	1	0	2	133	0	73	1	753	57	37	642	0

Major/Minor	Minor2		Minor1		Major1		Major2					
Conflicting Flow All	1540	1532	646	1480	1475	761	642	0	0	814	0	0
Stage 1	716	716	-	759	759	-	-	-	-	-	-	-
Stage 2	824	816	-	721	716	-	-	-	-	-	-	-
Critical Hdwy	7.12	6.52	6.22	7.1	6.52	6.2	4.12	-	-	4.15	-	-
Critical Hdwy Stg 1	6.12	5.52	-	6.1	5.52	-	-	-	-	-	-	-
Critical Hdwy Stg 2	6.12	5.52	-	6.1	5.52	-	-	-	-	-	-	-
Follow-up Hdwy	3.518	4.018	3.318	3.5	4.018	3.3	2.218	-	-	2.245	-	-
Pot Cap-1 Maneuver	94	117	472	~105	126	409	943	-	-	800	-	-
Stage 1	421	434	-	402	415	-	-	-	-	-	-	-
Stage 2	367	391	-	422	434	-	-	-	-	-	-	-
Platoon blocked, %								-	-	-	-	-
Mov Cap-1 Maneuver	74	111	470	~100	120	406	943	-	-	797	-	-
Mov Cap-2 Maneuver	74	111	-	284	299	-	-	-	-	-	-	-
Stage 1	421	414	-	400	413	-	-	-	-	-	-	-
Stage 2	299	389	-	399	414	-	-	-	-	-	-	-

Approach	EB		WB		NB		SB	
HCM Control Delay, s	26.7		23.9		0		0.5	
HCM LOS	D		C					

Minor Lane/Major Mvmt	NBL	NBT	NBR	EBLn1	WBLn1	WBLn2	SBL	SBT	SBR
Capacity (veh/h)	943	-	-	169	284	406	797	-	-
HCM Lane V/C Ratio	0.001	-	-	0.02	0.469	0.181	0.046	-	-
HCM Control Delay (s)	8.8	-	-	26.7	28.4	15.8	9.7	-	-
HCM Lane LOS	A	-	-	D	D	C	A	-	-
HCM 95th %tile Q(veh)	0	-	-	0.1	2.4	0.7	0.1	-	-

Notes
 ~: Volume exceeds capacity \$: Delay exceeds 300s +: Computation Not Defined *: All major volume in platoon

HCM 6th TWSC
6: SW Boones Ferry Road & Site Access

09/20/2021

Intersection												
Int Delay, s/veh	2.4											
Movement	EBL	EBT	EBR	WBL	WBT	WBR	NBL	NBT	NBR	SBL	SBT	SBR
Lane Configurations		↕			↕	↕	↕	↕	↕	↕	↕	
Traffic Vol, veh/h	1	0	1	86	0	52	2	626	134	75	812	0
Future Vol, veh/h	1	0	1	86	0	52	2	626	134	75	812	0
Conflicting Peds, #/hr	0	0	0	2	0	2	0	0	2	2	0	0
Sign Control	Stop	Stop	Stop	Stop	Stop	Stop	Free	Free	Free	Free	Free	Free
RT Channelized	-	-	None	-	-	None	-	-	None	-	-	None
Storage Length	-	-	-	-	-	150	150	-	150	150	-	-
Veh in Median Storage, #	-	0	-	-	2	-	-	0	-	-	0	-
Grade, %	-	0	-	-	0	-	-	0	-	-	0	-
Peak Hour Factor	92	92	92	95	92	95	92	95	95	95	95	92
Heavy Vehicles, %	2	2	2	0	2	0	2	3	3	2	2	2
Mvmt Flow	1	0	1	91	0	55	2	659	141	79	855	0

Major/Minor	Minor2		Minor1		Major1		Major2					
Conflicting Flow All	1776	1819	857	1681	1678	663	855	0	0	802	0	0
Stage 1	1013	1013	-	665	665	-	-	-	-	-	-	-
Stage 2	763	806	-	1016	1013	-	-	-	-	-	-	-
Critical Hdwy	7.12	6.52	6.22	7.1	6.52	6.2	4.12	-	-	4.12	-	-
Critical Hdwy Stg 1	6.12	5.52	-	6.1	5.52	-	-	-	-	-	-	-
Critical Hdwy Stg 2	6.12	5.52	-	6.1	5.52	-	-	-	-	-	-	-
Follow-up Hdwy	3.518	4.018	3.318	3.5	4.018	3.3	2.218	-	-	2.218	-	-
Pot Cap-1 Maneuver	64	78	357	~76	95	465	785	-	-	822	-	-
Stage 1	288	316	-	453	458	-	-	-	-	-	-	-
Stage 2	397	395	-	289	316	-	-	-	-	-	-	-
Platoon blocked, %								-	-	-	-	-
Mov Cap-1 Maneuver	52	70	356	~70	85	463	785	-	-	820	-	-
Mov Cap-2 Maneuver	52	70	-	220	240	-	-	-	-	-	-	-
Stage 1	287	286	-	451	456	-	-	-	-	-	-	-
Stage 2	349	393	-	260	286	-	-	-	-	-	-	-

Approach	EB		WB		NB		SB	
HCM Control Delay, s	45.5		25.3		0		0.8	
HCM LOS	E		D					

Minor Lane/Major Mvmt	NBL	NBT	NBR	EBLn1	WBLn1	WBLn2	SBL	SBT	SBR
Capacity (veh/h)	785	-	-	91	220	463	820	-	-
HCM Lane V/C Ratio	0.003	-	-	0.024	0.411	0.118	0.096	-	-
HCM Control Delay (s)	9.6	-	-	45.5	32.3	13.8	9.9	-	-
HCM Lane LOS	A	-	-	E	D	B	A	-	-
HCM 95th %tile Q(veh)	0	-	-	0.1	1.9	0.4	0.3	-	-

Notes
 ~: Volume exceeds capacity \$: Delay exceeds 300s +: Computation Not Defined *: All major volume in platoon

Intersection: 6: SW Boones Ferry Road & Site Access

Movement	EB	WB	WB	NB	NB	NB	SB	SB
Directions Served	LTR	LT	R	L	T	R	L	TR
Maximum Queue (ft)	31	187	128	6	72	10	44	32
Average Queue (ft)	4	65	24	0	6	0	9	2
95th Queue (ft)	19	136	60	4	35	6	32	15
Link Distance (ft)	318	1445			601			1805
Upstream Blk Time (%)								
Queuing Penalty (veh)								
Storage Bay Dist (ft)			150	150		150	150	
Storage Blk Time (%)		4						
Queuing Penalty (veh)		2						

Network Summary

Network wide Queuing Penalty: 2

Intersection: 6: SW Boones Ferry Road & Site Access

Movement	EB	WB	WB	NB	NB	NB	SB	SB
Directions Served	LTR	LT	R	L	T	R	L	TR
Maximum Queue (ft)	18	109	29	30	22	26	55	38
Average Queue (ft)	2	40	13	1	1	1	19	2
95th Queue (ft)	13	84	29	10	10	13	44	17
Link Distance (ft)	318	1810			670			1804
Upstream Blk Time (%)								
Queuing Penalty (veh)								
Storage Bay Dist (ft)			150	150		150	150	
Storage Blk Time (%)		0						
Queuing Penalty (veh)		0						

Intersection: 6: SW Boones Ferry Road & Site Access

Movement	EB	WB	WB	NB	NB	NB	SB	SB
Directions Served	LTR	LT	R	L	T	R	L	TR
Maximum Queue (ft)	30	140	48	12	88	10	32	28
Average Queue (ft)	3	59	22	0	5	0	8	2
95th Queue (ft)	17	124	42	6	42	5	28	13
Link Distance (ft)	318	1445			601			1805
Upstream Blk Time (%)								
Queuing Penalty (veh)								
Storage Bay Dist (ft)			150	150		150	150	
Storage Blk Time (%)		2			0			
Queuing Penalty (veh)		1			0			

Network Summary

Network wide Queuing Penalty: 1

Intersection: 6: SW Boones Ferry Road & Site Access

Movement	EB	WB	WB	NB	NB	NB	SB	SB
Directions Served	LTR	LT	R	L	T	R	L	TR
Maximum Queue (ft)	30	163	47	29	33	27	61	9
Average Queue (ft)	3	65	18	1	2	2	25	0
95th Queue (ft)	17	131	38	10	16	11	51	5
Link Distance (ft)	318	1810			670			1804
Upstream Blk Time (%)								
Queuing Penalty (veh)								
Storage Bay Dist (ft)			150	150		150	150	
Storage Blk Time (%)		2						
Queuing Penalty (veh)		1						

Intersection: 6: SW Boones Ferry Road & Site Access

Movement	EB	WB	WB	NB	NB	NB	SB	SB
Directions Served	LTR	LT	R	L	T	R	L	TR
Maximum Queue (ft)	35	224	171	5	76	32	54	46
Average Queue (ft)	3	85	33	0	6	2	16	3
95th Queue (ft)	17	185	99	3	37	13	42	21
Link Distance (ft)	318	1445			601			1805
Upstream Blk Time (%)								
Queuing Penalty (veh)								
Storage Bay Dist (ft)			150	150		150	150	
Storage Blk Time (%)		8						
Queuing Penalty (veh)		5						

Network Summary

Network wide Queuing Penalty: 5

Intersection: 6: SW Boones Ferry Road & Site Access

Movement	EB	WB	WB	NB	NB	NB	SB	SB
Directions Served	LTR	LT	R	L	T	R	L	TR
Maximum Queue (ft)	35	193	130	6	46	41	65	59
Average Queue (ft)	3	82	22	0	2	3	25	3
95th Queue (ft)	19	174	72	6	19	20	51	26
Link Distance (ft)	318	1810			670			1804
Upstream Blk Time (%)								
Queuing Penalty (veh)								
Storage Bay Dist (ft)			150	150		150	150	
Storage Blk Time (%)		7						0
Queuing Penalty (veh)		4						0