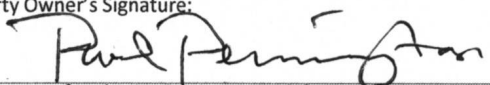
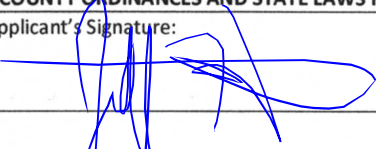

Land Use Application

Project Information																	
Project Title: Norwood Pump Station																	
Brief Description: Architectural Review for pump station serving Autumn Sunrise residential development																	
Property Information																	
Address: N/A																	
Assessor's Map Number and Tax Lots: Map 2S135D Tax Lot 100																	
Applicant/Primary Contact																	
Name: Jeff Hart	Company Name: Clean Water Services																
Address: 16060 SW 85th Avenue																	
City: Tigard	State: OR	ZIP: 97224															
Phone: 503-547-8150	Email: HartJ@CleanWaterServices.org																
Property Owner																	
Name: P3 Properties, LLC c/o Paul Pennington																	
Address: PO Box 691																	
City: White Salmon	State: WA	ZIP: 98672															
Phone: 206-841-2120	Email: paulpenning@gmail.com																
Property Owner's Signature: 		Date: 07/20/2021															
<i>(Note: Letter of authorization is required if not signed by owner)</i>																	
<p>AS THE PERSON RESPONSIBLE FOR THIS APPLICATION, I HEREBY ACKNOWLEDGE THAT I HAVE READ THIS APPLICATION AND STATE THAT THE INFORMATION IN AND INCLUDED WITH THIS APPLICATION IN ITS ENTIRETY IS CORRECT. I AGREE TO COMPLY WITH ALL APPLICABLE CITY AND COUNTY ORDINANCES AND STATE LAWS REGARDING BUILDING CONSTRUCTION AND LAND USE.</p>																	
Applicant's Signature: 		Date: 7/23/21															
<p>Land Use Application Type:</p> <table border="0"> <tr> <td><input type="checkbox"/> Annexation (ANN)</td> <td><input type="checkbox"/> Historic Landmark (HIST)</td> <td><input type="checkbox"/> Minor Architectural Review (MAR)</td> </tr> <tr> <td><input checked="" type="checkbox"/> Architectural Review (AR)</td> <td><input type="checkbox"/> Industrial Master Plan (IMP)</td> <td><input type="checkbox"/> Minor Variance (MVAR)</td> </tr> <tr> <td><input type="checkbox"/> Architectural Review—Single Family (ARSF)</td> <td><input type="checkbox"/> Plan Map Amendment (PMA)</td> <td><input type="checkbox"/> Sign Variance (SVAR)</td> </tr> <tr> <td><input type="checkbox"/> Architectural Review—ADU (ARADU)</td> <td><input type="checkbox"/> Plan Text Amendment (PTA)</td> <td><input type="checkbox"/> Variance (VAR)</td> </tr> <tr> <td><input type="checkbox"/> Conditional Use (CUP)</td> <td><input checked="" type="checkbox"/> Tree Removal/Review (TCP)</td> <td></td> </tr> </table>			<input type="checkbox"/> Annexation (ANN)	<input type="checkbox"/> Historic Landmark (HIST)	<input type="checkbox"/> Minor Architectural Review (MAR)	<input checked="" type="checkbox"/> Architectural Review (AR)	<input type="checkbox"/> Industrial Master Plan (IMP)	<input type="checkbox"/> Minor Variance (MVAR)	<input type="checkbox"/> Architectural Review—Single Family (ARSF)	<input type="checkbox"/> Plan Map Amendment (PMA)	<input type="checkbox"/> Sign Variance (SVAR)	<input type="checkbox"/> Architectural Review—ADU (ARADU)	<input type="checkbox"/> Plan Text Amendment (PTA)	<input type="checkbox"/> Variance (VAR)	<input type="checkbox"/> Conditional Use (CUP)	<input checked="" type="checkbox"/> Tree Removal/Review (TCP)	
<input type="checkbox"/> Annexation (ANN)	<input type="checkbox"/> Historic Landmark (HIST)	<input type="checkbox"/> Minor Architectural Review (MAR)															
<input checked="" type="checkbox"/> Architectural Review (AR)	<input type="checkbox"/> Industrial Master Plan (IMP)	<input type="checkbox"/> Minor Variance (MVAR)															
<input type="checkbox"/> Architectural Review—Single Family (ARSF)	<input type="checkbox"/> Plan Map Amendment (PMA)	<input type="checkbox"/> Sign Variance (SVAR)															
<input type="checkbox"/> Architectural Review—ADU (ARADU)	<input type="checkbox"/> Plan Text Amendment (PTA)	<input type="checkbox"/> Variance (VAR)															
<input type="checkbox"/> Conditional Use (CUP)	<input checked="" type="checkbox"/> Tree Removal/Review (TCP)																
Office Use																	
Case No:	Date Received:	Received by:															
Fee:	Receipt No:																

**Norwood Pump Station
Neighborhood Meeting Notes
June 30, 2021 at 6 pm**

The Norwood Pump Station development team from Clean Water Services and Tetra Tech hosted a virtual neighborhood meeting (via Microsoft Teams) on June 30, 2021 at 6 pm. Notice was carried out in accordance with the applicable standards in the Tualatin Development Code Chapter 32.120. There were two residents in attendance during the meeting. Tetra Tech Project Manager, Matt Huxley, initiated the presentation by introducing the team and giving a brief overview of the proposed pump station that will serve the associated Autumn Sunrise subdivision development. Clean Water Services Project Manager, Jeff Hart, then spoke to offer details about the role of Clean Water Services as well as the operations and maintenance of the pump station. After the overview, the development team opened a forum for questions and concerns.

One resident wanted to know if the Pump Station was alike to a wastewater treatment facility, citing general concerns about the potential for odor. Jeff referred to the example photos sent out in the notice and explained that the Norwood Pump Station would function to move (pump) wastewater from the proposed subdivision to the appropriate wastewater facility uphill. He explained the Norwood Pump Station will have odor treatments installed, though no odors are anticipated.

Both residents in attendance expressed support for the Pump Station, but shared concerns about potential traffic generated by the Autumn Sunrise project. Specifically, there were concerns about through-traffic onto Vermillion Dr from the proposed road extension in the subdivision. The residents wondered what might be done to mitigate the increase of traffic from the new development. Jeff explained that the Pump Station itself would not generate an increase of traffic because it would only produce about 1 trip per week from a maintenance vehicle. He explained that the Autumn Sunrise subdivision will have a traffic study with findings as part of that development application. In the meantime, Jeff offered to take down these concerns in the meeting notes which will be passed on to City staff as part of the Pump Station development application.

At this point, there were no further questions. The presenters thanked those in attendance and closed the meeting at 6:44 pm.

Service Provider Letter

This form and the attached conditions will serve as your Service Provider Letter in accordance with Clean Water Services Design and Construction Standards (R&O 19-5, as amended by R&O 19-22).

Jurisdiction: City of Tualatin Review Type: Tier 2 Analysis

Site Address / Location: SW Boones Ferry/SW Norwood Rd SPL Issue Date: June 23, 2021
Tualatin, OR 97062 SPL Expiration Date: June 23, 2023

Applicant Information:

Name SONYA TEMPLETON
Company AKS ENGINEERING & FORESTRY LLC
12965 SW HERMAN RD SUITE 100
Address TUALATIN OR 97062
Phone/Fax (503) 867-2613
E-mail: templetons@aks-eng.com

Owner Information:

Name DAVID FORCE
Company LENNAR NORTHWEST INC
11807 NE 99TH STREET, SUITE 1170
Address VANCOUVER WA 98682
Phone/Fax (360) 258-7879
E-mail: David.force@lennar.com

Tax lot ID

2S135D000100, 400, 401,
500, 501, 600, 800, 900

Development Activity

Autumn Sunrise Residential Subdivision

Pre-Development Site Conditions:

Sensitive Area Present: On-Site Off-Site
Vegetated Corridor Width: 50
Vegetated Corridor Condition: Degraded

Post Development Site Conditions:

Sensitive Area Present: On-Site Off-Site
Vegetated Corridor Width: _____

Enhancement of Remaining
Vegetated Corridor Required:

Square Footage to be enhanced: _____

Encroachments into Pre-Development Vegetated Corridor:

Type and location of Encroachment: Stormwater Facility (Permanent Encroachment; Mitigation Required) Square Footage: 11,011

Mitigation Requirements:

Type/Location Per R&O 13-12 VC Encroachment Mitigation Requirement Met Through Wetland Mitigation Bank Credit Purchase Sq. Ft./Ratio/Cost _____

Conditions Attached Development Figures Attached (2) Planting Plan Attached Geotech Report Required

This Service Provider Letter does NOT eliminate the need to evaluate and protect water quality sensitive areas if they are subsequently discovered on your property.

In order to comply with Clean Water Services water quality protection requirements the project must comply with the following conditions:

1. No structures, development, construction activities, gardens, lawns, application of chemicals, uncontained areas of hazardous materials as defined by Oregon Department of Environmental Quality, pet wastes, dumping of materials of any kind, or other activities shall be permitted within the sensitive area or Vegetated Corridor which may negatively impact water quality, except those allowed in R&O 19-5, Chapter 3, as amended by R&O 19-22.
2. Prior to any site clearing, grading or construction the Vegetated Corridor and water quality sensitive areas shall be surveyed, staked, and temporarily fenced per approved plan. During construction the Vegetated Corridor shall remain fenced and undisturbed except as allowed by R&O 19-5, Section 3.06.1, as amended by R&O 19-22 and per approved plans.
3. **Prior to any activity within the sensitive area, the applicant shall gain authorization for the project from the Oregon Department of State Lands (DSL) and US Army Corps of Engineers (USACE). The applicant shall provide Clean Water Services or its designee (appropriate city) with copies of all DSL and USACE project authorization permits.**
4. An approved Oregon Department of Forestry Notification is required for one or more trees harvested for sale, trade, or barter, on any non-federal lands within the State of Oregon.
5. Prior to any ground disturbing activities, an erosion control permit is required. Appropriate Best Management Practices (BMP's) for Erosion Control, in accordance with Clean Water Services' Erosion Prevention and Sediment Control Planning and Design Manual, shall be used prior to, during, and following earth disturbing activities.
6. Prior to construction, a Stormwater Connection Permit from Clean Water Services or its designee is required pursuant to Ordinance 27, Section 4.B.
7. The water quality swale and detention pond shall be planted with Clean Water Services approved native species, and designed to blend into the natural surroundings.
8. **Should final development plans differ significantly from those submitted for review by Clean Water Services, the applicant shall provide updated drawings, and if necessary, obtain a revised Service Provider Letter.**

This Service Provider Letter is not valid unless CWS-approved site plan is attached.

Please call (503) 681-3667 with any questions.

Stacy Benjamin

**Stacy Benjamin
Environmental Plan Review**

Attachments (2)



- LEGEND (COLOR COPY):**
- ON-SITE PEM/SLOPE WETLAND A:
1,930 SF± (0.04 ACRES±)
 - ON-SITE DEGRADED CONDITION VEGETATED CORRIDOR:
11,011 SF± (0.25 ACRES±)
 - PHOTO LOCATION & ORIENTATION

WETLAND BOUNDARY SHOWN WAS DELINEATED BY AKS ENGINEERING & FORESTRY, LLC ON 02/24/2020 AND WAS LOCATED USING A TRIMBLE GEO 7X HANDHELD GPS RECEIVER WITH SUB-METER ACCURACY.

1-FOOT INTERVAL CONTOURS DERIVED FROM NOAA LIDAR EXISTING CONDITIONS, AND STUDY AREA ARE DERIVED FROM AKS LAND SURVEY WITH SUB-METER ACCURACY.

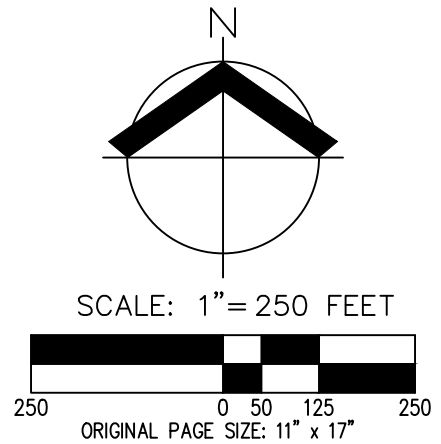

DATE: 05/24/2021

NATURAL RESOURCES EXISTING CONDITIONS OVERVIEW	FIGURE
AUTUMN SUNRISE NATURAL RESOURCE ASSESSMENT	5
AKS ENGINEERING & FORESTRY, LLC 12965 SW HERMAN RD, STE 100 TUALATIN, OR 97062 503.563.6151 WWW.AKS-ENG.COM	DRWN: SKT CHKD: SAR AKS JOB: 7454

CWS FILE NO. 21-001425
 Approved
 Clean Water Services
 FOR ENVIRONMENTAL REVIEW
 By SNB Date 6/23/2021
 SPL ATTACHMENT 2 OF 2

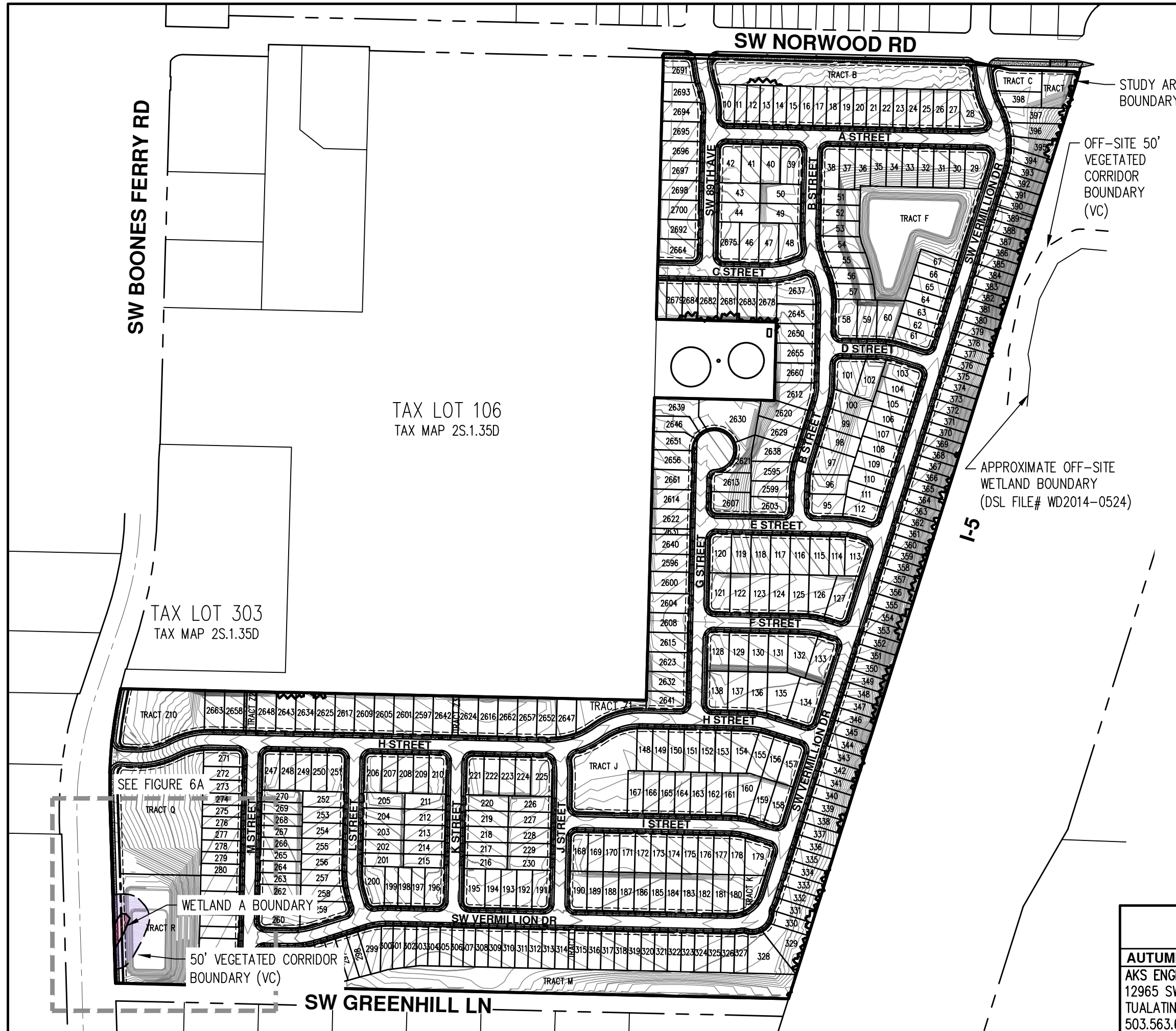

- LEGEND (COLOR COPY):**
- ON-SITE WETLAND A AREA:
1,930 SF± (0.04 ACRES±)
 - PERMANENT ON-SITE WETLAND A IMPACT AREA:
1,930 SF± (0.04 ACRES±)
 - PERMANENT VEGETATED CORRIDOR IMPACT AREA:
11,011 SF± (0.25 ACRES±)

WETLAND BOUNDARY SHOWN WAS DELINEATED BY AKS ENGINEERING AND FORESTRY, LLC ON 02/24/2020 AND WAS LOCATED USING A TRIMBLE GEO 7X HANDHELD GPS RECEIVER WITH SUB-METER ACCURACY.

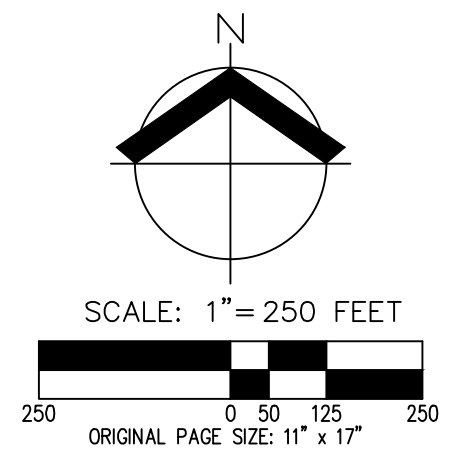

DATE: 5/26/2021

SUBDIVISION SITE PLAN OVERVIEW		EXHIBIT
AUTUMN SUNRISE NATURAL RESOURCE ASSESSMENT		6
AKS ENGINEERING & FORESTRY, LLC 12965 SW HERMAN RD, STE 100 TUALATIN, OR 97062 503.563.6151 WWW.AKS-ENG.COM		DRWN: JSM CHKD: ST AKS JOB: 7454

Autumn Sunrise Preliminary Tree Assessment Report

Date: July 1, 2021

Prepared For: Lennar Northwest, Inc.
11807 NE 99th Street, Suite 1170
Vancouver, WA 98682

Prepared By: Bruce R. Baldwin
ISA Certified Arborist No.: PN-6666A
ISA Qualified Tree Risk Assessor
bruce@aks-eng.com

Site Location: 23620 & 23740 SW Boones Ferry Road;
9185, 9335, & 9415 SW Greenhill Lane
South of SW Norwood Road, east of SW Boones Ferry Road,
and north of SW Greenhill Lane; Tualatin, OR



12965 SW Herman Road, Suite 100
Tualatin, OR 97062
(503) 563-6151

Project Summary

This project consists of a 400-lot subdivision for future detached single-family homes. The purpose of this Arborist Report is to document information related to existing on-site trees, planned tree preservation and removal for the project, and protection measures for trees to be preserved.

Tree Inventory & Evaluation

Site visits were conducted between February 1st & April 12th, 2021 to evaluate existing on-site trees. The trees were evaluated for species, DBH, average crown radius, and visually assessed for tree health and condition. Please refer to "Appendix A – Tree Inventory" for the above-mentioned information as well as additional tree related information.

Tree Preservation & Removal Plan

The Preliminary Tree Preservation and Removal Plan (dated July 1, 2021) was prepared by a Certified Arborist. For additional tree related information, protection measures, and tree protection fencing locations, please refer to the "Preliminary Tree Preservation and Removal Plan."

Arborist Disclosure Statement

Arborists are tree specialists who use their education, knowledge, training, and experience to examine trees, recommend measures to enhance the health of trees, and attempt to reduce the risk of living near trees. The Client and Jurisdiction may choose to accept or disregard the recommendations of the arborist, or seek additional advice. Arborists cannot detect every condition that could possibly lead to the structural failure of a tree. Trees are living organisms that fail in ways we do not fully understand. Conditions are often hidden within trees and below ground. Arborists cannot guarantee that a tree will be healthy or safe under all circumstances, or for a specified period of time. Likewise, remedial treatments, like medicine, cannot be guaranteed. Trees can be managed, but they cannot be controlled. To live near trees is to accept some degree of risk. The only way to eliminate all risk associated with trees is to eliminate all trees.

Neither this author nor AKS Engineering & Forestry, LLC have assumed any responsibility for liability associated with the trees on or adjacent to this site.

Sincerely,

AKS ENGINEERING & FORESTRY, LLC



Bruce R. Baldwin

ISA Certified Arborist, ISA Qualified Tree Risk Assessor
12965 SW Herman Road, Suite 100, Tualatin, OR 97062
503-563-6151 | bruce@aks-eng.com



Appendix A - Detailed Tree Inventory

Detailed Tree Inventory for Autumn Sunrise							
AKS Job No. 7454 - Evaluation Date: 2/1/2021 - 4/12/2021 - Evaluated by: BRK							
Tree #	DBH (in.)	Avg. Crown Radius (ft)	Tree Species Common Name (<i>Scientific name</i>)	Comments	Health Rating*	Structure Rating**	Remove/Preserve
10068	8,10	14	Pacific Dogwood (<i>Cornus nuttallii</i>)		1	1	Remove
10214	10	20	Bigleaf Maple (<i>Acer macrophyllum</i>)	Significant lean (E); Uprooting; Dead scaffold branches	2	3	Remove
10216	44	26	Douglas-fir (<i>Pseudotsuga menziesii</i>)	Codominant with included bark; 1-sided canopy (W)	1	2	Remove
10217	30	20	Douglas-fir (<i>Pseudotsuga menziesii</i>)	1-sided canopy (S)	1	2	Remove
10221	23	16	Douglas-fir (<i>Pseudotsuga menziesii</i>)	1-sided canopy (W)	1	2	Remove
10222	25	16	Douglas-fir (<i>Pseudotsuga menziesii</i>)	1-sided canopy (W)	1	2	Remove
10224	8	20	Bigleaf Maple (<i>Acer macrophyllum</i>)	Bulges at base	2	1	Remove
10225	29	13	English Hawthorn (<i>Crataegus monogyna</i>)	Lean (W)	1	2	Remove
10229	10	8	Douglas-fir (<i>Pseudotsuga menziesii</i>)		1	1	Remove
10235	22	17	Oregon White Oak (<i>Quercus garryana</i>)		1	1	Remove
10239	9	8	Douglas-fir (<i>Pseudotsuga menziesii</i>)	Exposed buttress root with damage (S)	2	1	Remove
10244	8	8	Douglas-fir (<i>Pseudotsuga menziesii</i>)		1	1	Remove
10249	44	16	Douglas-fir (<i>Pseudotsuga menziesii</i>)		1	1	Remove
10251	20	21	Douglas-fir (<i>Pseudotsuga menziesii</i>)	OFFSITE; 1-sided canopy (N)	1	2	Remove
10253	28	19	Douglas-fir (<i>Pseudotsuga menziesii</i>)	OFFSITE; 1-sided canopy (E)	1	2	Remove
10254	9	9	Douglas-fir (<i>Pseudotsuga menziesii</i>)	OFFSITE	1	1	Remove
10255	31	12	Douglas-fir (<i>Pseudotsuga menziesii</i>)	OFFSITE; 1-sided canopy (N)	1	2	Remove
10257	32	14	Douglas-fir (<i>Pseudotsuga menziesii</i>)	OFFSITE; Bore holes; 1-sided canopy (E)	2	2	Remove
10258	26	12	Douglas-fir (<i>Pseudotsuga menziesii</i>)	OFFSITE; High canopy; Very sparse canopy; Branch dieback	2	3	Remove
10261	13	13	Bigleaf Maple (<i>Acer macrophyllum</i>)	OFFSITE	1	1	Preserve
10264	19	13	Douglas-fir (<i>Pseudotsuga menziesii</i>)	OFFSITE; High canopy; Sparse canopy	2	2	Remove
10266	25	16	Douglas-fir (<i>Pseudotsuga menziesii</i>)	OFFSITE; 1-sided canopy (E)	1	2	Remove
10268	38	20	Douglas-fir (<i>Pseudotsuga menziesii</i>)	OFFSITE	1	1	Remove
10270	23	15	Douglas-fir (<i>Pseudotsuga menziesii</i>)	OFFSITE	1	1	Remove
10271	36	17	Douglas-fir (<i>Pseudotsuga menziesii</i>)	OFFSITE	1	1	Remove
10273	8	7	Douglas-fir (<i>Pseudotsuga menziesii</i>)	1-sided canopy (NE)	1	2	Remove
10274	43	19	Douglas-fir (<i>Pseudotsuga menziesii</i>)	1-sided canopy (N)	1	2	Remove
10275	43	26	Douglas-fir (<i>Pseudotsuga menziesii</i>)	1-sided canopy (S)	1	2	Remove
10278	8	8	Douglas-fir (<i>Pseudotsuga menziesii</i>)		1	1	Remove
10279	9,20	22	Bigleaf Maple (<i>Acer macrophyllum</i>)	Cavity with decay up bole	2	2	Remove
10281	16	12	Douglas-fir (<i>Pseudotsuga menziesii</i>)	Deformed bole	1	2	Remove
10282	22	17	Douglas-fir (<i>Pseudotsuga menziesii</i>)	1-sided canopy (S)	1	2	Remove
10283	23	19	Douglas-fir (<i>Pseudotsuga menziesii</i>)		1	1	Remove
10285	29	15	Douglas-fir (<i>Pseudotsuga menziesii</i>)		1	1	Remove
10286	22	15	Douglas-fir (<i>Pseudotsuga menziesii</i>)	Codominant top with included bark	1	2	Remove
10288	32	24	Douglas-fir (<i>Pseudotsuga menziesii</i>)		1	1	Preserve
10291	9	9	Douglas-fir (<i>Pseudotsuga menziesii</i>)		1	1	Preserve
10295	9	10	Douglas-fir (<i>Pseudotsuga menziesii</i>)		1	1	Preserve
10299	9	10	Douglas-fir (<i>Pseudotsuga menziesii</i>)		1	1	Preserve
10300	9	11	Douglas-fir (<i>Pseudotsuga menziesii</i>)	1-sided canopy (N)	1	2	Remove
10301	11	11	Douglas-fir (<i>Pseudotsuga menziesii</i>)	1-sided canopy (N)	1	2	Remove
10303	10	9	Douglas-fir (<i>Pseudotsuga menziesii</i>)		1	1	Remove
10363	34	15	Douglas-fir (<i>Pseudotsuga menziesii</i>)	OFFSITE	1	1	Preserve
10392	46	15	Douglas-fir (<i>Pseudotsuga menziesii</i>)	OFFSITE	1	1	Preserve
10394	35	15	Douglas-fir (<i>Pseudotsuga menziesii</i>)	OFFSITE	1	1	Preserve
10430	49	21	Douglas-fir (<i>Pseudotsuga menziesii</i>)	OFFSITE; Some broken limbs	1	1	Preserve
10436	17	11	Maple (<i>Acer sp.</i>)	Evaluated behind fence; Crooked bole	1	2	Remove
10600	9,6	9	Cherry (<i>Prunus sp.</i>)	OFFSITE	1	1	Preserve
10789	14	16	Douglas-fir (<i>Pseudotsuga menziesii</i>)	OFFSITE	1	1	Preserve
10791	12	14	Cherry (<i>Prunus sp.</i>)	Evaluated behind fence	1	1	Remove
10792	16	30	Weeping Cypress (<i>Cupressus nootkatensis</i>)	Evaluated behind fence	1	1	Remove
10834	13	16	Basswood (<i>Tilia americana</i>)	Evaluated behind fence; Several medium cavities with decay	1	1	Remove
10846	10	6	Cottonwood (<i>Populus sp.</i>)	Evaluated behind fence	1	1	Remove
10867	13	14	Douglas-fir (<i>Pseudotsuga menziesii</i>)	OFFSITE	1	1	Preserve
10870	10	15	Douglas-fir (<i>Pseudotsuga menziesii</i>)	OFFSITE	1	1	Preserve
10871	13	15	Douglas-fir (<i>Pseudotsuga menziesii</i>)	OFFSITE	1	1	Preserve
10876	15	16	Douglas-fir (<i>Pseudotsuga menziesii</i>)	OFFSITE	1	1	Preserve
10879	14	15	Douglas-fir (<i>Pseudotsuga menziesii</i>)	OFFSITE; Codominant top	1	2	Preserve
10880	12	16	Douglas-fir (<i>Pseudotsuga menziesii</i>)	OFFSITE	1	1	Preserve
10881	8,7	14	Douglas-fir (<i>Pseudotsuga menziesii</i>)	OFFSITE; Codominant base with included bark	1	2	Preserve
10916	14	15	Maple (<i>Acer sp.</i>)	OFFSITE; Street Trees; Some broken limbs	1	1	Preserve
10919	15	13	Maple (<i>Acer sp.</i>)	OFFSITE; Street Trees; Some broken limbs	1	1	Preserve
10921	9	8	Maple (<i>Acer sp.</i>)	OFFSITE; Street Trees; Some broken limbs	1	1	Preserve
10923	16	15	Maple (<i>Acer sp.</i>)	OFFSITE; Street Trees; Some broken limbs	1	1	Preserve
11138	12	14	Scotch Pine (<i>Pinus sylvestris</i>)	OFFSITE; Evaluated from property line	1	1	Preserve
11221	8	9	Douglas-fir (<i>Pseudotsuga menziesii</i>)		1	1	Preserve
11222	8	8	Douglas-fir (<i>Pseudotsuga menziesii</i>)		1	1	Preserve
11223	8	10	Douglas-fir (<i>Pseudotsuga menziesii</i>)	1-sided canopy (N)	1	2	Remove

Detailed Tree Inventory for Autumn Sunrise

AKS Job No. 7454 - Evaluation Date: 2/1/2021 - 4/12/2021 - Evaluated by: BRK

Tree #	DBH (in.)	Avg. Crown Radius (ft)	Tree Species Common Name (Scientific name)	Comments	Health Rating*	Structure Rating**	Remove/Preserve
11225	8	7	Douglas-fir (<i>Pseudotsuga menziesii</i>)		1	1	Preserve
11227	8	7	Douglas-fir (<i>Pseudotsuga menziesii</i>)	Broken top	2	3	Remove
11237	44	30	Douglas-fir (<i>Pseudotsuga menziesii</i>)	N side pruned for overhead wires	1	1	Remove
11240	38	23	Douglas-fir (<i>Pseudotsuga menziesii</i>)		1	1	Remove
11241	38	25	Douglas-fir (<i>Pseudotsuga menziesii</i>)		1	1	Remove
11243	10	15	Bigleaf Maple (<i>Acer macrophyllum</i>)		1	1	Preserve
11253	8	8	Douglas-fir (<i>Pseudotsuga menziesii</i>)		1	1	Remove
11254	9	8	Douglas-fir (<i>Pseudotsuga menziesii</i>)		1	1	Remove
11256	9	9	Douglas-fir (<i>Pseudotsuga menziesii</i>)		1	1	Remove
11257	9	11	Douglas-fir (<i>Pseudotsuga menziesii</i>)		1	1	Remove
11262	31	22	Douglas-fir (<i>Pseudotsuga menziesii</i>)		1	1	Remove
11263	32	21	Douglas-fir (<i>Pseudotsuga menziesii</i>)	Crooked bole	1	2	Remove
11264	20	30	Bigleaf Maple (<i>Acer macrophyllum</i>)	Lean (N); Crooked bole; Dead lower scaffold branches; 1-sided canopy (W)	1	2	Remove
11265	11,11	35	Bigleaf Maple (<i>Acer macrophyllum</i>)	Stems lean (E&W)	1	2	Remove
11271	15,25	18	Douglas-fir (<i>Pseudotsuga menziesii</i>)	Codominant base with included bark; Codominant top; High canopy	1	2	Remove
11272	8,8	17	Bigleaf Maple (<i>Acer macrophyllum</i>)	Lean (S); Crooked bole; Branch dieback	2	2	Remove
11273	14,16,17	22	Bigleaf Maple (<i>Acer macrophyllum</i>)		1	1	Remove
11277	29	16	Douglas-fir (<i>Pseudotsuga menziesii</i>)		1	1	Remove
11278	20	19	Bigleaf Maple (<i>Acer macrophyllum</i>)	1-sided canopy (E); Dead limbs	2	2	Remove
11280	21	17	Douglas-fir (<i>Pseudotsuga menziesii</i>)	Deformed bole	1	2	Remove
11282	31	20	Douglas-fir (<i>Pseudotsuga menziesii</i>)		1	1	Remove
11312	24	21	Bigleaf Maple (<i>Acer macrophyllum</i>)	Large cavities with decay; Bulges; Crooked bole	2	2	Remove
11313	21,28	28	Bigleaf Maple (<i>Acer macrophyllum</i>)	Exposed roots (E); Lean (W)	1	2	Remove
11315	25	17	Douglas-fir (<i>Pseudotsuga menziesii</i>)	High canopy; 1-sided canopy (W)	1	2	Remove
11320	31	14	Bigleaf Maple (<i>Acer macrophyllum</i>)	Large cavity with decay in base	2	3	Remove
11321	28	20	Bigleaf Maple (<i>Acer macrophyllum</i>)		1	1	Remove
11322	8	0	Bigleaf Maple (<i>Acer macrophyllum</i>)	Dead	3	3	Remove
11324	12,12,15,16,16	20	Bigleaf Maple (<i>Acer macrophyllum</i>)	1-sided canopy (W)	1	2	Remove
11325	25,31	16	Bigleaf Maple (<i>Acer macrophyllum</i>)	Failed Codominant stems; 100% ivy coverage; Sparse canopy; In decline	3	3	Remove
11330	40	18	Douglas-fir (<i>Pseudotsuga menziesii</i>)		1	1	Remove
11331	33	18	Douglas-fir (<i>Pseudotsuga menziesii</i>)		1	1	Remove
11332	32	17	Douglas-fir (<i>Pseudotsuga menziesii</i>)	1-sided canopy (W)	1	2	Remove
11334	36	17	Douglas-fir (<i>Pseudotsuga menziesii</i>)		1	1	Remove
11336	24	15	Douglas-fir (<i>Pseudotsuga menziesii</i>)	1-sided canopy (S)	1	2	Remove
11338	21	16	Bigleaf Maple (<i>Acer macrophyllum</i>)	crooked bole	1	2	Remove
11339	21	17	Bigleaf Maple (<i>Acer macrophyllum</i>)	Some broken limbs	1	1	Remove
11340	25	14	Douglas-fir (<i>Pseudotsuga menziesii</i>)	High canopy	1	2	Remove
11343	12,13,20	20	Bigleaf Maple (<i>Acer macrophyllum</i>)	Dead limbs; Exposed roots (S)	2	1	Remove
11344	10	0	Douglas-fir (<i>Pseudotsuga menziesii</i>)	Dead	3	3	Remove
11345	26	20	Bigleaf Maple (<i>Acer macrophyllum</i>)		1	1	Remove
11346	27	16	Douglas-fir (<i>Pseudotsuga menziesii</i>)		1	1	Remove
11349	18,14	19	Bigleaf Maple (<i>Acer macrophyllum</i>)	Lean (N)	1	2	Remove
11350	25	25	Bigleaf Maple (<i>Acer macrophyllum</i>)	Stems lean (E&W); Dead limbs	2	2	Remove
11351	10	16	Bigleaf Maple (<i>Acer macrophyllum</i>)	high canopy; Top lean (E)	1	2	Remove
11352	12	16	Bigleaf Maple (<i>Acer macrophyllum</i>)	high canopy; Top lean (E)	1	2	Remove
11353	15	17	Bigleaf Maple (<i>Acer macrophyllum</i>)	high canopy	1	2	Remove
11354	8	0	Bigleaf Maple (<i>Acer macrophyllum</i>)	Dead; lean (N)	3	3	Remove
11355	16	16	Bigleaf Maple (<i>Acer macrophyllum</i>)	Dead limbs; high canopy	2	2	Remove
11356	16	19	Bigleaf Maple (<i>Acer macrophyllum</i>)		1	1	Remove
11357	16	16	Bigleaf Maple (<i>Acer macrophyllum</i>)	Crooked bole	1	2	Remove
11359	8,22,23	26	Bigleaf Maple (<i>Acer macrophyllum</i>)	1-sided canopy (S)	1	2	Remove
11360	25	15	Douglas-fir (<i>Pseudotsuga menziesii</i>)		1	1	Remove
11361	18	21	Bigleaf Maple (<i>Acer macrophyllum</i>)	Lean (S); Broken limbs	1	2	Remove
11362	20,21,23	27	Bigleaf Maple (<i>Acer macrophyllum</i>)	1-sided canopy (W)	1	2	Remove
11363	29	30	Bigleaf Maple (<i>Acer macrophyllum</i>)		1	1	Remove
11368	8	8	Douglas-fir (<i>Pseudotsuga menziesii</i>)	Broken top	2	3	Remove
11377	30	22	Douglas-fir (<i>Pseudotsuga menziesii</i>)		1	1	Remove
11380	44	20	Douglas-fir (<i>Pseudotsuga menziesii</i>)		1	1	Remove
11385	37	40	Bigleaf Maple (<i>Acer macrophyllum</i>)	Weakly attached scaffold branches; 50% ivy coverage; Dead scaffold branches	2	2	Preserve
11388	21	0	Bigleaf Maple (<i>Acer macrophyllum</i>)	Snag	3	3	Remove
11389	21	25	Bigleaf Maple (<i>Acer macrophyllum</i>)	Lean (E); 100% ivy coverage; Dead scaffold branches	2	2	Remove
11391	28	0	Bigleaf Maple (<i>Acer macrophyllum</i>)	Dead; Broken at 30'	3	3	Remove
11392	12	0	Bigleaf Maple (<i>Acer macrophyllum</i>)	Dead; Broken at 30'	3	3	Remove
11393	11	18	Bigleaf Maple (<i>Acer macrophyllum</i>)	Dead limbs; Very sparse canopy; 1-sided canopy (E)	3	2	Remove
11394	21	19	Bigleaf Maple (<i>Acer macrophyllum</i>)	100% ivy coverage; high canopy	1	2	Remove
11396	27	18	Douglas-fir (<i>Pseudotsuga menziesii</i>)		1	1	Remove

Detailed Tree Inventory for Autumn Sunrise

AKS Job No. 7454 - Evaluation Date: 2/1/2021 - 4/12/2021 - Evaluated by: BRK

Tree #	DBH (in.)	Avg. Crown Radius (ft)	Tree Species Common Name (Scientific name)	Comments	Health Rating*	Structure Rating**	Remove/Preserve
11397	15	20	Bigleaf Maple (<i>Acer macrophyllum</i>)	High canopy; Lean (W)	1	2	Remove
11401	26	22	Bigleaf Maple (<i>Acer macrophyllum</i>)		1	1	Remove
11403	27	16	Douglas-fir (<i>Pseudotsuga menziesii</i>)		1	1	Remove
11412	8	9	Douglas-fir (<i>Pseudotsuga menziesii</i>)		1	1	Remove
11422	22	16	Douglas-fir (<i>Pseudotsuga menziesii</i>)	1-sided canopy (S)	1	2	Remove
11426	57	18	Douglas-fir (<i>Pseudotsuga menziesii</i>)	Broken limbs	1	1	Remove
11430	43	19	Douglas-fir (<i>Pseudotsuga menziesii</i>)	1-sided canopy (SW)	1	2	Remove
11435	15	14	Bigleaf Maple (<i>Acer macrophyllum</i>)	Lean (S); Dead branches	2	2	Remove
11445	21	17	Oregon White Oak (<i>Quercus garryana</i>)		1	1	Remove
11447	30	23	Douglas-fir (<i>Pseudotsuga menziesii</i>)		1	1	Remove
11448	33	18	Douglas-fir (<i>Pseudotsuga menziesii</i>)		1	1	Remove
11453	35	0	Douglas-fir (<i>Pseudotsuga menziesii</i>)	Dead; Broken at 15'	3	3	Remove
11456	15	0	Douglas-fir (<i>Pseudotsuga menziesii</i>)	OFFSITE; Evaluated from property line; Dead	3	3	Preserve
11457	13	0	Douglas-fir (<i>Pseudotsuga menziesii</i>)	OFFSITE; Evaluated from property line; Dead	3	3	Preserve
11459	10	6	Douglas-fir (<i>Pseudotsuga menziesii</i>)	OFFSITE; Evaluated from property line; Epicormic sprouts	2	1	Preserve
11463	10	15	Willow (<i>Salix sp.</i>)	Lean (W)	1	2	Remove
11465	16	0	Willow (<i>Salix sp.</i>)	Dead	3	3	Remove
11467	22	17	Douglas-fir (<i>Pseudotsuga menziesii</i>)	Sweep (E); 50% ivy coverage; 1-sided canopy (E)	1	2	Remove
11468	27	23	Douglas-fir (<i>Pseudotsuga menziesii</i>)	1-sided canopy (S)	1	2	Remove
11469	22,6	13	Bigleaf Maple (<i>Acer macrophyllum</i>)	100% ivy coverage; high canopy; Dead branches	2	2	Remove
11472	20	16	Douglas-fir (<i>Pseudotsuga menziesii</i>)		1	1	Remove
11474	11	0	Douglas-fir (<i>Pseudotsuga menziesii</i>)	Dead	3	3	Remove
11475	22	16	Douglas-fir (<i>Pseudotsuga menziesii</i>)	1-sided canopy (S)	1	2	Remove
11484	29	18	Douglas-fir (<i>Pseudotsuga menziesii</i>)	Sweep (N)	1	2	Remove
11486	29	19	Douglas-fir (<i>Pseudotsuga menziesii</i>)		1	1	Remove
11487	18	13	Douglas-fir (<i>Pseudotsuga menziesii</i>)	Suppressed	2	2	Remove
11490	18	17	Douglas-fir (<i>Pseudotsuga menziesii</i>)		1	1	Remove
11491	14,9,7	19	Bigleaf Maple (<i>Acer macrophyllum</i>)		1	1	Remove
11494	14	16	Douglas-fir (<i>Pseudotsuga menziesii</i>)	1-sided canopy (S)	1	2	Remove
11496	30	15	Douglas-fir (<i>Pseudotsuga menziesii</i>)	Epicormic sprouts	2	1	Remove
11497	33	17	Douglas-fir (<i>Pseudotsuga menziesii</i>)	LINE TREE; Evaluated from property line; 1-sided canopy (E)	1	2	Remove
11498	23	18	Douglas-fir (<i>Pseudotsuga menziesii</i>)	LINE TREE; Evaluated from property line; 1-sided canopy (E)	1	2	Remove
11510	13	17	Douglas-fir (<i>Pseudotsuga menziesii</i>)	OFFSITE; Evaluated from property line; 1-sided canopy (S)	1	2	Preserve
11511	13	6	Douglas-fir (<i>Pseudotsuga menziesii</i>)	OFFSITE; Evaluated from property line; Dead top; Sparse canopy; In decline	3	2	Preserve
11514	13	17	Bigleaf Maple (<i>Acer macrophyllum</i>)	OFFSITE; Evaluated from property line; 1-sided canopy (S)	1	2	Remove
11516	26	14	Douglas-fir (<i>Pseudotsuga menziesii</i>)	OFFSITE; Evaluated from property line	1	1	Remove
11517	28	15	Douglas-fir (<i>Pseudotsuga menziesii</i>)	OFFSITE; Evaluated from property line; 1-sided canopy (E)	1	2	Remove
11518	20	14	Douglas-fir (<i>Pseudotsuga menziesii</i>)	OFFSITE; Evaluated from property line	1	1	Remove
11520	24	16	Douglas-fir (<i>Pseudotsuga menziesii</i>)	OFFSITE; Evaluated from property line	1	1	Remove
11521	26	16	Douglas-fir (<i>Pseudotsuga menziesii</i>)	OFFSITE; Evaluated from property line	1	1	Remove
11523	26	0	Douglas-fir (<i>Pseudotsuga menziesii</i>)	OFFSITE; Evaluated from property line; Dead (75')	3	3	Remove
11524	29	18	Douglas-fir (<i>Pseudotsuga menziesii</i>)	OFFSITE; Evaluated from property line	1	1	Remove
11544	9	8	Douglas-fir (<i>Pseudotsuga menziesii</i>)		1	1	Remove
11545	9	8	Douglas-fir (<i>Pseudotsuga menziesii</i>)		1	1	Remove
11547	32	17	Douglas-fir (<i>Pseudotsuga menziesii</i>)	Epicormic sprouts	2	1	Remove
11548	23	19	Douglas-fir (<i>Pseudotsuga menziesii</i>)	Epicormic sprouts	2	1	Remove
11549	30	18	Douglas-fir (<i>Pseudotsuga menziesii</i>)	Epicormic sprouts; Dead limbs	2	1	Remove
11550	22	13	Douglas-fir (<i>Pseudotsuga menziesii</i>)		1	1	Remove
11554	13	14	Douglas-fir (<i>Pseudotsuga menziesii</i>)	1-sided canopy (W)	1	2	Remove
11555	24	16	Douglas-fir (<i>Pseudotsuga menziesii</i>)	High canopy; Epicormic sprouts; Small conks up bole	3	2	Remove
11557	13	11	Douglas-fir (<i>Pseudotsuga menziesii</i>)	Epicormic sprouts; Sparse canopy	2	2	Remove
11558	18	12	Douglas-fir (<i>Pseudotsuga menziesii</i>)	Epicormic sprouts; Sweep; high canopy	2	2	Remove
11559	10	0	Douglas-fir (<i>Pseudotsuga menziesii</i>)	Dead	3	3	Remove
11560	32	18	Douglas-fir (<i>Pseudotsuga menziesii</i>)		1	1	Remove
11563	12	16	Douglas-fir (<i>Pseudotsuga menziesii</i>)	Suppressed; Crooked bole	2	2	Remove
11565	25	19	Douglas-fir (<i>Pseudotsuga menziesii</i>)	Epicormic sprouts	2	1	Remove
11567	29	20	Douglas-fir (<i>Pseudotsuga menziesii</i>)	Crooked bole	1	2	Remove
11568	29	16	Douglas-fir (<i>Pseudotsuga menziesii</i>)	High canopy	1	2	Remove
11569	22	15	Douglas-fir (<i>Pseudotsuga menziesii</i>)	1-sided canopy (W)	1	2	Remove
11572	36	17	Douglas-fir (<i>Pseudotsuga menziesii</i>)		1	1	Remove
11575	17	16	Oregon White Oak (<i>Quercus garryana</i>)		1	1	Remove
11577	14	18	Oregon White Oak (<i>Quercus garryana</i>)	1-sided canopy (N)	1	2	Remove
11578	32	27	Douglas-fir (<i>Pseudotsuga menziesii</i>)	Crooked bole; Codominant	1	2	Remove
11579	40	20	Douglas-fir (<i>Pseudotsuga menziesii</i>)		1	1	Remove
11581	44	25	Black Cottonwood (<i>Populus trichocarpa</i>)	Codominant top with included bark; Dead limbs	2	2	Remove
11589	20	15	Douglas-fir (<i>Pseudotsuga menziesii</i>)	Epicormic sprouts; Sparse canopy	2	2	Remove
11591	20	12	Douglas-fir (<i>Pseudotsuga menziesii</i>)	OFFSITE; Evaluated from property line; Sweep (N); Epicormic sprouts; Sluffing bark; In decline	3	2	Remove

Detailed Tree Inventory for Autumn Sunrise

AKS Job No. 7454 - Evaluation Date: 2/1/2021 - 4/12/2021 - Evaluated by: BRK

Tree #	DBH (in.)	Avg. Crown Radius (ft)	Tree Species Common Name (<i>Scientific name</i>)	Comments	Health Rating*	Structure Rating**	Remove/Preserve
11597	18	16	Douglas-fir (<i>Pseudotsuga menziesii</i>)	OFFSITE; Evaluated from property line; Epicormic sprouts; Sparse canopy	2	2	Remove
11598	18	0	Douglas-fir (<i>Pseudotsuga menziesii</i>)	Dead; broken at 10'	3	3	Remove
11599	22	16	Douglas-fir (<i>Pseudotsuga menziesii</i>)		1	1	Remove
11607	26	20	Douglas-fir (<i>Pseudotsuga menziesii</i>)	Sweep (N)	1	2	Remove
11608	38	18	Douglas-fir (<i>Pseudotsuga menziesii</i>)	Deformed bole; 1-sided canopy (S)	1	2	Remove
11612	29	20	Douglas-fir (<i>Pseudotsuga menziesii</i>)		1	1	Remove
11623	20	19	Douglas-fir (<i>Pseudotsuga menziesii</i>)	1-sided canopy (W)	1	2	Remove
11627	22	16	Douglas-fir (<i>Pseudotsuga menziesii</i>)	1-sided canopy (W)	1	2	Remove
11628	22	14	Douglas-fir (<i>Pseudotsuga menziesii</i>)	1-sided canopy (S)	1	2	Remove
11629	23	14	Douglas-fir (<i>Pseudotsuga menziesii</i>)	Butt sweep; 1-sided canopy (S)	1	2	Remove
11633	30	10	Douglas-fir (<i>Pseudotsuga menziesii</i>)	OFFSITE; Evaluated from property line; Sluffing bark; Epicormic sprouts; In decline	3	2	Remove
11635	14	16	Douglas-fir (<i>Pseudotsuga menziesii</i>)	OFFSITE; Evaluated from property line; Epicormic Sprouts; Sparse canopy; 1-sided canopy (S)	2	2	Preserve
11636	14	13	Douglas-fir (<i>Pseudotsuga menziesii</i>)	OFFSITE; Evaluated from property line; Epicormic Sprouts; Sparse canopy	2	2	Preserve
11644	30	16	Douglas-fir (<i>Pseudotsuga menziesii</i>)	Dead branches; Dead foliage	2	1	Remove
11645	9	12	English Hawthorn (<i>Crataegus monogyna</i>)	Broken top; Dead limbs	2	3	Remove
11646	21	15	Douglas-fir (<i>Pseudotsuga menziesii</i>)	1-sided canopy (S)	1	2	Remove
11649	24	16	Douglas-fir (<i>Pseudotsuga menziesii</i>)		1	1	Remove
11652	29	12	Douglas-fir (<i>Pseudotsuga menziesii</i>)		1	1	Remove
11658	10,12,14,20	27	Bigleaf Maple (<i>Acer macrophyllum</i>)		1	1	Remove
11659	28	15	Douglas-fir (<i>Pseudotsuga menziesii</i>)		1	1	Remove
11664	26	16	Douglas-fir (<i>Pseudotsuga menziesii</i>)	Sweep (E)	1	2	Remove
11665	17	15	Douglas-fir (<i>Pseudotsuga menziesii</i>)	1-sided canopy (N)	1	2	Remove
11667	20	15	Douglas-fir (<i>Pseudotsuga menziesii</i>)	1-sided canopy (S)	1	2	Remove
11669	8	0	Bigleaf Maple (<i>Acer macrophyllum</i>)	Dead; Lean (S)	3	3	Remove
11670	36	17	Douglas-fir (<i>Pseudotsuga menziesii</i>)	Hooked bole	1	2	Remove
11671	18	16	Douglas-fir (<i>Pseudotsuga menziesii</i>)		1	1	Remove
11678	19	11	Douglas-fir (<i>Pseudotsuga menziesii</i>)	LINE TREE; Evaluated from property line; Broken branches; High canopy	1	2	Remove
11681	20	16	Douglas-fir (<i>Pseudotsuga menziesii</i>)	OFFSITE; Evaluated from property line	1	1	Preserve
11682	10	15	Douglas-fir (<i>Pseudotsuga menziesii</i>)	OFFSITE; Evaluated from property line; Suppressed; 1-sided canopy (W)	2	2	Preserve
11683	19	15	Douglas-fir (<i>Pseudotsuga menziesii</i>)	OFFSITE; Evaluated from property line	1	1	Preserve
11686	14	20	Douglas-fir (<i>Pseudotsuga menziesii</i>)	1-sided canopy (W)	1	2	Remove
11688	26	15	Douglas-fir (<i>Pseudotsuga menziesii</i>)		1	1	Remove
11690	28	18	Douglas-fir (<i>Pseudotsuga menziesii</i>)	1-sided canopy (S)	1	2	Remove
11691	29	20	Douglas-fir (<i>Pseudotsuga menziesii</i>)	1-sided canopy (E)	1	2	Remove
11694	28	19	Douglas-fir (<i>Pseudotsuga menziesii</i>)		1	1	Remove
11695	15	15	Douglas-fir (<i>Pseudotsuga menziesii</i>)	1-sided canopy (W)	1	2	Remove
11697	23	20	Douglas-fir (<i>Pseudotsuga menziesii</i>)	1-sided canopy (W)	1	2	Remove
11699	15	14	Douglas-fir (<i>Pseudotsuga menziesii</i>)		1	1	Remove
11704	9	9	Douglas-fir (<i>Pseudotsuga menziesii</i>)	Broken top	2	3	Remove
11705	9	6	Douglas-fir (<i>Pseudotsuga menziesii</i>)		1	1	Remove
11708	8	0	Douglas-fir (<i>Pseudotsuga menziesii</i>)	Broken at 10'	3	3	Remove
11713	9	0	Douglas-fir (<i>Pseudotsuga menziesii</i>)	Dead; broken at 40'	3	3	Remove
11714	9	0	Douglas-fir (<i>Pseudotsuga menziesii</i>)	Dead; broken at 40'	3	3	Remove
11715	31	17	Douglas-fir (<i>Pseudotsuga menziesii</i>)		1	1	Remove
11716	10	0	Douglas-fir (<i>Pseudotsuga menziesii</i>)	Dead; broken at 40'	3	3	Remove
11718	10	6	Douglas-fir (<i>Pseudotsuga menziesii</i>)		1	1	Remove
11720	8	0	Douglas-fir (<i>Pseudotsuga menziesii</i>)	Dead; broken at 40'	3	3	Remove
11721	9	4	Douglas-fir (<i>Pseudotsuga menziesii</i>)	Broken top; Sparse canopy	2	3	Remove
11723	9	7	Douglas-fir (<i>Pseudotsuga menziesii</i>)	1-sided canopy (N)	1	2	Remove
11724	8	5	Douglas-fir (<i>Pseudotsuga menziesii</i>)	Broken top; Sparse canopy	2	3	Remove
11725	8	4	Douglas-fir (<i>Pseudotsuga menziesii</i>)	Broken top; Sparse canopy	2	3	Remove
11729	14	16	Douglas-fir (<i>Pseudotsuga menziesii</i>)	1-sided canopy (E)	1	2	Remove
11730	33	20	Douglas-fir (<i>Pseudotsuga menziesii</i>)		1	1	Remove
11731	24	23	Douglas-fir (<i>Pseudotsuga menziesii</i>)	1-sided canopy (S)	1	2	Remove
11732	19	15	Douglas-fir (<i>Pseudotsuga menziesii</i>)	1-sided canopy (N)	1	2	Remove
11733	17	15	Douglas-fir (<i>Pseudotsuga menziesii</i>)	1-sided canopy (W)	1	2	Remove
11734	33	22	Douglas-fir (<i>Pseudotsuga menziesii</i>)	1-sided canopy (S)	1	2	Remove
11735	28	15	Douglas-fir (<i>Pseudotsuga menziesii</i>)	Codominant with included bark; High canopy; Sparse canopy	2	2	Remove
11736	16,17	20	Douglas-fir (<i>Pseudotsuga menziesii</i>)	Codominant with included bark; High canopy; Sparse canopy	2	2	Remove
11737	10,17	19	Douglas-fir (<i>Pseudotsuga menziesii</i>)	Codominant base with included bark	1	2	Remove
11738	27	19	Douglas-fir (<i>Pseudotsuga menziesii</i>)	1-sided canopy (S)	1	2	Remove
11739	10	0	Douglas-fir (<i>Pseudotsuga menziesii</i>)	Dead	3	3	Remove
11740	10	7	Douglas-fir (<i>Pseudotsuga menziesii</i>)	Broken top; Sparse canopy	2	3	Remove

Detailed Tree Inventory for Autumn Sunrise

AKS Job No. 7454 - Evaluation Date: 2/1/2021 - 4/12/2021 - Evaluated by: BRK

Tree #	DBH (in.)	Avg. Crown Radius (ft)	Tree Species Common Name (<i>Scientific name</i>)	Comments	Health Rating*	Structure Rating**	Remove/Preserve
11743	10	5	Douglas-fir (<i>Pseudotsuga menziesii</i>)		1	1	Remove
11745	8	5	Douglas-fir (<i>Pseudotsuga menziesii</i>)	Broken top; Sparse canopy	2	3	Remove
11746	9	8	Douglas-fir (<i>Pseudotsuga menziesii</i>)		1	1	Remove
11747	8	3	Douglas-fir (<i>Pseudotsuga menziesii</i>)	Sparse canopy; High canopy	2	2	Remove
11748	9	3	Douglas-fir (<i>Pseudotsuga menziesii</i>)	Broken top; Sparse canopy	2	3	Remove
11749	9	3	Douglas-fir (<i>Pseudotsuga menziesii</i>)	Broken top; Sparse canopy	2	3	Remove
11750	9	2	Douglas-fir (<i>Pseudotsuga menziesii</i>)	Broken top; Sparse canopy	2	3	Remove
11751	9	4	Douglas-fir (<i>Pseudotsuga menziesii</i>)	Broken top; Sparse canopy	2	3	Remove
11752	12	0	Douglas-fir (<i>Pseudotsuga menziesii</i>)	Dead; Broken at 40'	3	3	Remove
11753	9	6	Douglas-fir (<i>Pseudotsuga menziesii</i>)		1	1	Remove
11754	10	6	Douglas-fir (<i>Pseudotsuga menziesii</i>)		1	1	Remove
11755	10	8	Douglas-fir (<i>Pseudotsuga menziesii</i>)		1	1	Remove
11756	9	8	Douglas-fir (<i>Pseudotsuga menziesii</i>)		1	1	Remove
11757	8	0	Douglas-fir (<i>Pseudotsuga menziesii</i>)	Dead; broken at 20'	3	3	Remove
11760	11	12	Douglas-fir (<i>Pseudotsuga menziesii</i>)	1-sided canopy (S)	1	2	Remove
11761	8	5	Douglas-fir (<i>Pseudotsuga menziesii</i>)	High canopy	1	2	Remove
11762	9	5	Douglas-fir (<i>Pseudotsuga menziesii</i>)	Broken top; Sparse canopy	2	3	Remove
11763	10	8	Douglas-fir (<i>Pseudotsuga menziesii</i>)		1	1	Remove
11766	8	8	Douglas-fir (<i>Pseudotsuga menziesii</i>)		1	1	Remove
11771	8,17	18	Douglas-fir (<i>Pseudotsuga menziesii</i>)	1-sided canopy (S)	1	2	Remove
11772	20	20	Douglas-fir (<i>Pseudotsuga menziesii</i>)	Bulges at base; 1-sided canopy (S)	2	2	Remove
11773	31	21	Douglas-fir (<i>Pseudotsuga menziesii</i>)	1-sided canopy (W)	1	2	Remove
11774	39	25	Douglas-fir (<i>Pseudotsuga menziesii</i>)	1-sided canopy (SW); broken limbs	1	2	Remove
11775	8	5	Douglas-fir (<i>Pseudotsuga menziesii</i>)	Broken top; Sparse canopy	2	3	Remove
11777	11	10	Douglas-fir (<i>Pseudotsuga menziesii</i>)		1	1	Remove
11778	10	8	Douglas-fir (<i>Pseudotsuga menziesii</i>)		1	1	Remove
11779	14	10	Douglas-fir (<i>Pseudotsuga menziesii</i>)	1-sided canopy (N)	1	2	Remove
11780	9	6	Douglas-fir (<i>Pseudotsuga menziesii</i>)		1	1	Remove
11783	8	7	Douglas-fir (<i>Pseudotsuga menziesii</i>)		1	1	Remove
11784	10	13	Douglas-fir (<i>Pseudotsuga menziesii</i>)	1-sided canopy (N)	1	2	Remove
11785	9	6	Douglas-fir (<i>Pseudotsuga menziesii</i>)		1	1	Remove
11786	9	9	Douglas-fir (<i>Pseudotsuga menziesii</i>)		1	1	Remove
11787	9	6	Douglas-fir (<i>Pseudotsuga menziesii</i>)		1	1	Remove
11788	9	6	Douglas-fir (<i>Pseudotsuga menziesii</i>)		1	1	Remove
11790	11	12	Douglas-fir (<i>Pseudotsuga menziesii</i>)	1-sided canopy (N)	1	2	Remove
11792	11	8	Douglas-fir (<i>Pseudotsuga menziesii</i>)		1	1	Remove
11793	8	6	Douglas-fir (<i>Pseudotsuga menziesii</i>)		1	1	Remove
11794	10	7	Douglas-fir (<i>Pseudotsuga menziesii</i>)		1	1	Remove
11796	8	5	Douglas-fir (<i>Pseudotsuga menziesii</i>)		1	1	Remove
11797	9	6	Douglas-fir (<i>Pseudotsuga menziesii</i>)		1	1	Remove
11798	11	9	Douglas-fir (<i>Pseudotsuga menziesii</i>)		1	1	Remove
11799	10	6	Douglas-fir (<i>Pseudotsuga menziesii</i>)		1	1	Remove
11800	11	8	Douglas-fir (<i>Pseudotsuga menziesii</i>)		1	1	Remove
11801	9	4	Douglas-fir (<i>Pseudotsuga menziesii</i>)	High canopy	1	2	Remove
11802	9	7	Douglas-fir (<i>Pseudotsuga menziesii</i>)		1	1	Remove
11803	8	4	Douglas-fir (<i>Pseudotsuga menziesii</i>)		1	1	Remove
11805	9	4	Douglas-fir (<i>Pseudotsuga menziesii</i>)		1	1	Remove
11806	13	10	Douglas-fir (<i>Pseudotsuga menziesii</i>)		1	1	Remove
11808	12	13	Douglas-fir (<i>Pseudotsuga menziesii</i>)	1-sided canopy (S)	1	2	Remove
11810	10	0	Douglas-fir (<i>Pseudotsuga menziesii</i>)	Dead; Broken at 50'	3	3	Remove
11811	10	9	Douglas-fir (<i>Pseudotsuga menziesii</i>)		1	1	Remove
11812	9	5	Douglas-fir (<i>Pseudotsuga menziesii</i>)		1	1	Remove
11813	12	11	Douglas-fir (<i>Pseudotsuga menziesii</i>)		1	1	Remove
11814	11	8	Douglas-fir (<i>Pseudotsuga menziesii</i>)		1	1	Remove
11816	12	4	Douglas-fir (<i>Pseudotsuga menziesii</i>)	High canopy	1	1	Remove
11817	9	6	Douglas-fir (<i>Pseudotsuga menziesii</i>)		1	1	Remove
11818	9	7	Douglas-fir (<i>Pseudotsuga menziesii</i>)	1-sided canopy (N)	1	2	Remove
11819	9	8	Douglas-fir (<i>Pseudotsuga menziesii</i>)		1	1	Remove
11821	10	5	Douglas-fir (<i>Pseudotsuga menziesii</i>)	High canopy	1	2	Remove
11822	11	7	Douglas-fir (<i>Pseudotsuga menziesii</i>)		1	1	Remove
11824	11	9	Douglas-fir (<i>Pseudotsuga menziesii</i>)		1	1	Remove
11828	11	6	Douglas-fir (<i>Pseudotsuga menziesii</i>)		1	1	Remove
11831	9	5	Douglas-fir (<i>Pseudotsuga menziesii</i>)	High canopy	1	2	Remove
11832	9	5	Douglas-fir (<i>Pseudotsuga menziesii</i>)	High canopy	1	2	Remove
11833	8	4	Douglas-fir (<i>Pseudotsuga menziesii</i>)	High canopy	1	2	Remove
11834	9	4	Douglas-fir (<i>Pseudotsuga menziesii</i>)	High canopy	1	2	Remove
11838	9	8	Douglas-fir (<i>Pseudotsuga menziesii</i>)	Broken top; Sparse canopy	2	3	Remove
11839	9	5	Douglas-fir (<i>Pseudotsuga menziesii</i>)		1	1	Remove
11840	9	6	Douglas-fir (<i>Pseudotsuga menziesii</i>)	Very top broken	2	2	Remove

Detailed Tree Inventory for Autumn Sunrise

AKS Job No. 7454 - Evaluation Date: 2/1/2021 - 4/12/2021 - Evaluated by: BRK

Tree #	DBH (in.)	Avg. Crown Radius (ft)	Tree Species Common Name (<i>Scientific name</i>)	Comments	Health Rating*	Structure Rating**	Remove/Preserve
11841	10	5	Douglas-fir (<i>Pseudotsuga menziesii</i>)		1	1	Remove
11843	9	4	Douglas-fir (<i>Pseudotsuga menziesii</i>)	Broken top; Sparse canopy	2	3	Remove
11844	9	6	Douglas-fir (<i>Pseudotsuga menziesii</i>)		1	1	Remove
11846	11	9	Douglas-fir (<i>Pseudotsuga menziesii</i>)		1	1	Remove
11850	16	20	Willow (<i>Salix sp.</i>)	Lean (W); Many broken limbs	2	2	Remove
11851	14	16	Douglas-fir (<i>Pseudotsuga menziesii</i>)	1-sided canopy (E)	1	2	Remove
11852	18	17	Douglas-fir (<i>Pseudotsuga menziesii</i>)		1	1	Remove
11855	18	16	Douglas-fir (<i>Pseudotsuga menziesii</i>)	1-sided canopy (N)	1	2	Remove
11856	21	18	Douglas-fir (<i>Pseudotsuga menziesii</i>)	1-sided canopy (E)	1	2	Remove
11857	20	12	Douglas-fir (<i>Pseudotsuga menziesii</i>)		1	1	Remove
11858	20	16	Douglas-fir (<i>Pseudotsuga menziesii</i>)		1	1	Remove
11863	11	10	Douglas-fir (<i>Pseudotsuga menziesii</i>)		1	1	Remove
11868	43	18	Douglas-fir (<i>Pseudotsuga menziesii</i>)	Codominant with included bark	1	2	Remove
11869	33	22	Douglas-fir (<i>Pseudotsuga menziesii</i>)	Sweep; 1-sided canopy (N)	1	2	Remove
11872	9	8	Douglas-fir (<i>Pseudotsuga menziesii</i>)	Broken top; Sparse canopy	2	3	Remove
11873	10	0	Douglas-fir (<i>Pseudotsuga menziesii</i>)	Dead; Broken at 40'; Lean (N)	3	3	Remove
11875	9	6	Douglas-fir (<i>Pseudotsuga menziesii</i>)	High canopy	1	2	Remove
11878	13	10	Douglas-fir (<i>Pseudotsuga menziesii</i>)		1	1	Remove
11882	9	8	Douglas-fir (<i>Pseudotsuga menziesii</i>)		1	1	Remove
11883	9	11	Douglas-fir (<i>Pseudotsuga menziesii</i>)		1	1	Remove
11885	12	11	Douglas-fir (<i>Pseudotsuga menziesii</i>)	Codominant with included bark	1	2	Remove
11886	12	9	Douglas-fir (<i>Pseudotsuga menziesii</i>)		1	1	Remove
11887	12	10	Douglas-fir (<i>Pseudotsuga menziesii</i>)		1	1	Remove
11890	9	7	Douglas-fir (<i>Pseudotsuga menziesii</i>)		1	1	Remove
11891	8	4	Douglas-fir (<i>Pseudotsuga menziesii</i>)	High canopy	1	2	Remove
11892	12	7	Douglas-fir (<i>Pseudotsuga menziesii</i>)		1	1	Remove
11895	13	13	Douglas-fir (<i>Pseudotsuga menziesii</i>)	1-sided canopy (N)	1	2	Remove
11897	12	7	Douglas-fir (<i>Pseudotsuga menziesii</i>)		1	1	Remove
11898	11	7	Douglas-fir (<i>Pseudotsuga menziesii</i>)		1	1	Remove
11899	11	6	Douglas-fir (<i>Pseudotsuga menziesii</i>)		1	1	Remove
11900	13	7	Douglas-fir (<i>Pseudotsuga menziesii</i>)		1	1	Remove
11901	12	7	Douglas-fir (<i>Pseudotsuga menziesii</i>)		1	1	Remove
11903	9	10	Douglas-fir (<i>Pseudotsuga menziesii</i>)	Uprooting (N)			Remove
11904	14	10	Douglas-fir (<i>Pseudotsuga menziesii</i>)		1	1	Remove
11905	8	8	Douglas-fir (<i>Pseudotsuga menziesii</i>)	Lean (N)	1	2	Remove
11906	12	12	Douglas-fir (<i>Pseudotsuga menziesii</i>)	1-sided canopy (N)	1	2	Remove
11907	11	11	Douglas-fir (<i>Pseudotsuga menziesii</i>)	1-sided canopy (N)	1	2	Remove
11909	11	6	Douglas-fir (<i>Pseudotsuga menziesii</i>)		1	1	Remove
11910	8	6	Douglas-fir (<i>Pseudotsuga menziesii</i>)	Broken top; Sparse canopy	2	3	Remove
11911	9	6	Douglas-fir (<i>Pseudotsuga menziesii</i>)		1	1	Remove
11912	10	6	Douglas-fir (<i>Pseudotsuga menziesii</i>)		1	1	Remove
11914	12	9	Douglas-fir (<i>Pseudotsuga menziesii</i>)		1	1	Remove
11915	9	6	Douglas-fir (<i>Pseudotsuga menziesii</i>)		1	1	Remove
11916	8	7	Douglas-fir (<i>Pseudotsuga menziesii</i>)	Uprooting (N)	2	3	Remove
11917	15	13	Douglas-fir (<i>Pseudotsuga menziesii</i>)		1	1	Remove
11918	10	7	Douglas-fir (<i>Pseudotsuga menziesii</i>)		1	1	Remove
11923	8	7	Douglas-fir (<i>Pseudotsuga menziesii</i>)		1	1	Remove
11924	11	10	Douglas-fir (<i>Pseudotsuga menziesii</i>)	Codominant top with included bark	1	2	Remove
11925	14	17	Douglas-fir (<i>Pseudotsuga menziesii</i>)	1-sided canopy (W)	1	2	Remove
11927	13	9	Douglas-fir (<i>Pseudotsuga menziesii</i>)	Crooked top	1	2	Remove
11928	16	11	Douglas-fir (<i>Pseudotsuga menziesii</i>)		1	1	Remove
11929	11	8	Douglas-fir (<i>Pseudotsuga menziesii</i>)		1	1	Remove
11931	12	9	Douglas-fir (<i>Pseudotsuga menziesii</i>)		1	1	Remove
11934	9	7	Douglas-fir (<i>Pseudotsuga menziesii</i>)		1	1	Remove
11935	10	11	Douglas-fir (<i>Pseudotsuga menziesii</i>)	1-sided canopy (S)	1	2	Remove
11936	16	15	Douglas-fir (<i>Pseudotsuga menziesii</i>)	1-sided canopy (W)	1	2	Remove
11937	9	14	Douglas-fir (<i>Pseudotsuga menziesii</i>)	1-sided canopy (N)	1	2	Remove
11942	9	7	Douglas-fir (<i>Pseudotsuga menziesii</i>)		1	1	Remove
11943	12	8	Douglas-fir (<i>Pseudotsuga menziesii</i>)		1	1	Remove
11944	11	7	Douglas-fir (<i>Pseudotsuga menziesii</i>)		1	1	Remove
11945	9	7	Douglas-fir (<i>Pseudotsuga menziesii</i>)		1	1	Remove
11946	11	7	Douglas-fir (<i>Pseudotsuga menziesii</i>)		1	1	Remove
11947	12	15	Douglas-fir (<i>Pseudotsuga menziesii</i>)		1	1	Remove
11949	10	16	Douglas-fir (<i>Pseudotsuga menziesii</i>)		1	1	Remove
11950	10	8	Douglas-fir (<i>Pseudotsuga menziesii</i>)		1	1	Remove
11952	8	10	Douglas-fir (<i>Pseudotsuga menziesii</i>)	1-sided canopy (E)	1	2	Remove
11953	12	18	Douglas-fir (<i>Pseudotsuga menziesii</i>)		1	1	Remove
11955	12	14	Douglas-fir (<i>Pseudotsuga menziesii</i>)	1-sided canopy (W)	1	2	Remove
11957	8	7	Douglas-fir (<i>Pseudotsuga menziesii</i>)		1	1	Remove

Detailed Tree Inventory for Autumn Sunrise

AKS Job No. 7454 - Evaluation Date: 2/1/2021 - 4/12/2021 - Evaluated by: BRK

Tree #	DBH (in.)	Avg. Crown Radius (ft)	Tree Species Common Name (<i>Scientific name</i>)	Comments	Health Rating*	Structure Rating**	Remove/Preserve
11958	8	15	Douglas-fir (<i>Pseudotsuga menziesii</i>)	1-sided canopy (W)	1	2	Remove
11960	11	7	Douglas-fir (<i>Pseudotsuga menziesii</i>)		1	1	Remove
11961	8	7	Douglas-fir (<i>Pseudotsuga menziesii</i>)		1	1	Remove
11963	9	7	Douglas-fir (<i>Pseudotsuga menziesii</i>)		1	1	Remove
11965	12	13	Douglas-fir (<i>Pseudotsuga menziesii</i>)		1	1	Remove
11967	10	11	Douglas-fir (<i>Pseudotsuga menziesii</i>)	Broken top; Sparse canopy	2	3	Remove
11971	9	10	Douglas-fir (<i>Pseudotsuga menziesii</i>)	Broken top; Sparse canopy	2	3	Remove
11972	10	7	Douglas-fir (<i>Pseudotsuga menziesii</i>)		1	1	Remove
11975	8	6	Douglas-fir (<i>Pseudotsuga menziesii</i>)	Tree fallen on top	2	2	Remove
11980	9	7	Douglas-fir (<i>Pseudotsuga menziesii</i>)		1	1	Remove
11988	9	15	Douglas-fir (<i>Pseudotsuga menziesii</i>)	Broken top; 1-sided canopy (N)	2	3	Remove
12001	8	0	Douglas-fir (<i>Pseudotsuga menziesii</i>)	Dead; Broken at 10'	3	3	Remove
12009	10	6	Douglas-fir (<i>Pseudotsuga menziesii</i>)		1	1	Remove
12020	8	6	Douglas-fir (<i>Pseudotsuga menziesii</i>)		1	1	Remove
12025	19	20	Douglas-fir (<i>Pseudotsuga menziesii</i>)	Broken top; 1-sided canopy (N)	2	3	Remove
12030	9	10	Douglas-fir (<i>Pseudotsuga menziesii</i>)		1	1	Remove
12031	8	9	Douglas-fir (<i>Pseudotsuga menziesii</i>)	1-sided canopy (N)	1	2	Remove
12032	8	10	Douglas-fir (<i>Pseudotsuga menziesii</i>)	1-sided canopy (W)	1	2	Remove
12058	10	10	Douglas-fir (<i>Pseudotsuga menziesii</i>)	1-sided canopy (W)	1	2	Preserve
12059	13	10	Douglas-fir (<i>Pseudotsuga menziesii</i>)		1	1	Remove
12060	23	16	Douglas-fir (<i>Pseudotsuga menziesii</i>)		1	1	Remove
12062	25	19	Douglas-fir (<i>Pseudotsuga menziesii</i>)		1	1	Remove
12067	22	18	Douglas-fir (<i>Pseudotsuga menziesii</i>)	1-sided canopy (W)	1	2	Remove
12068	20	20	Douglas-fir (<i>Pseudotsuga menziesii</i>)	1-sided canopy (N)	1	2	Remove
12071	8	6	Douglas-fir (<i>Pseudotsuga menziesii</i>)		1	1	Remove
12073	9	7	Douglas-fir (<i>Pseudotsuga menziesii</i>)		1	1	Remove
12075	9	9	Douglas-fir (<i>Pseudotsuga menziesii</i>)		1	1	Remove
12076	9	9	Douglas-fir (<i>Pseudotsuga menziesii</i>)		1	1	Remove
12080	8	7	Douglas-fir (<i>Pseudotsuga menziesii</i>)		1	1	Remove
12083	8	8	Douglas-fir (<i>Pseudotsuga menziesii</i>)	1-sided canopy (E)	1	2	Remove
12089	25	20	Douglas-fir (<i>Pseudotsuga menziesii</i>)		1	1	Remove
12090	8	8	Douglas-fir (<i>Pseudotsuga menziesii</i>)	Suppressed	2	2	Remove
12091	25	16	Douglas-fir (<i>Pseudotsuga menziesii</i>)	1-sided canopy (S)	1	2	Remove
12093	30	20	Douglas-fir (<i>Pseudotsuga menziesii</i>)	1-sided canopy (W)	1	2	Remove
12098	28	20	Douglas-fir (<i>Pseudotsuga menziesii</i>)		1	1	Remove
12100	14	10	Douglas-fir (<i>Pseudotsuga menziesii</i>)		1	1	Remove
12101	8	9	Douglas-fir (<i>Pseudotsuga menziesii</i>)	Suppressed	2	2	Remove
12102	24	19	Douglas-fir (<i>Pseudotsuga menziesii</i>)		1	1	Remove
12103	24	17	Douglas-fir (<i>Pseudotsuga menziesii</i>)		1	1	Remove
12107	19	13	Douglas-fir (<i>Pseudotsuga menziesii</i>)	1-sided canopy (N)	1	2	Remove
12108	19	12	Douglas-fir (<i>Pseudotsuga menziesii</i>)	1-sided canopy (N); high canopy	1	2	Remove
12109	26	16	Douglas-fir (<i>Pseudotsuga menziesii</i>)		1	1	Remove
12111	17	12	Douglas-fir (<i>Pseudotsuga menziesii</i>)	1-sided canopy (W)	1	2	Remove
12112	19	15	Douglas-fir (<i>Pseudotsuga menziesii</i>)	1-sided canopy (N); Crooked bole	1	2	Remove
12118	14	14	Douglas-fir (<i>Pseudotsuga menziesii</i>)		1	1	Remove
12120	8	6	Douglas-fir (<i>Pseudotsuga menziesii</i>)	1-sided canopy (W)	1	2	Remove
12122	11	6	Douglas-fir (<i>Pseudotsuga menziesii</i>)		1	1	Remove
12123	10	7	Douglas-fir (<i>Pseudotsuga menziesii</i>)		1	1	Remove
12124	10	5	Douglas-fir (<i>Pseudotsuga menziesii</i>)		1	1	Remove
12126	12	9	Douglas-fir (<i>Pseudotsuga menziesii</i>)		1	1	Remove
12128	8	0	Douglas-fir (<i>Pseudotsuga menziesii</i>)	Dead; Broken at 40'	3	3	Remove
12132	23	18	Douglas-fir (<i>Pseudotsuga menziesii</i>)	OFFSITE; Evaluated from property line	1	1	Remove
12139	32	20	Douglas-fir (<i>Pseudotsuga menziesii</i>)	OFFSITE; Evaluated from property line	1	1	Remove
12141	11	20	Bigleaf Maple (<i>Acer macrophyllum</i>)	OFFSITE; Evaluated from property line	1	1	Remove
12144	15	0	Douglas-fir (<i>Pseudotsuga menziesii</i>)	Dead; Suppressed	3	3	Remove
12145	22	17	Douglas-fir (<i>Pseudotsuga menziesii</i>)	1-sided canopy (N)	1	2	Remove
12149	21	15	Douglas-fir (<i>Pseudotsuga menziesii</i>)	1-sided canopy (S)	1	2	Remove
12158	19	16	Douglas-fir (<i>Pseudotsuga menziesii</i>)		1	1	Remove
12159	25	20	Douglas-fir (<i>Pseudotsuga menziesii</i>)		1	1	Remove
12161	9	9	Douglas-fir (<i>Pseudotsuga menziesii</i>)		1	1	Remove
12162	11	11	Douglas-fir (<i>Pseudotsuga menziesii</i>)		1	1	Remove
12164	38	20	Douglas-fir (<i>Pseudotsuga menziesii</i>)		1	1	Remove
12166	24	20	Douglas-fir (<i>Pseudotsuga menziesii</i>)	1-sided canopy (E)	1	2	Remove
12172	17	17	Oregon White Oak (<i>Quercus garryana</i>)		1	1	Remove
12174	27	23	Douglas-fir (<i>Pseudotsuga menziesii</i>)	Lean (SE); High canopy; Crooked bole	1	2	Remove
12175	27	17	Douglas-fir (<i>Pseudotsuga menziesii</i>)	Sparse canopy; High canopy	2	2	Remove
12177	31	20	Douglas-fir (<i>Pseudotsuga menziesii</i>)		1	1	Remove
12181	14	10	Oregon White Oak (<i>Quercus garryana</i>)		1	1	Remove
12184	8	6	Douglas-fir (<i>Pseudotsuga menziesii</i>)		1	1	Remove

Detailed Tree Inventory for Autumn Sunrise

AKS Job No. 7454 - Evaluation Date: 2/1/2021 - 4/12/2021 - Evaluated by: BRK

Tree #	DBH (in.)	Avg. Crown Radius (ft)	Tree Species Common Name (<i>Scientific name</i>)	Comments	Health Rating*	Structure Rating**	Remove/Preserve
12189	18	9	Douglas-fir (<i>Pseudotsuga menziesii</i>)	Dead branches	2	1	Remove
12192	18	25	Oregon White Oak (<i>Quercus garryana</i>)	OFFSITE; Evaluated from property line; 1-sided canopy (W); Several failed limbs	2	2	Remove
12194	14	0	Douglas-fir (<i>Pseudotsuga menziesii</i>)	OFFSITE; Evaluated from property line; Dead (60')	3	3	Preserve
12196	9,6	16	Oregon White Oak (<i>Quercus garryana</i>)	OFFSITE; Evaluated from property line; 1-sided canopy (E)	1	2	Preserve
12198	14,14,9	22	Oregon White Oak (<i>Quercus garryana</i>)	OFFSITE; Evaluated from property line; 1-sided canopy (W)	1	2	Preserve
12202	10	10	Oregon White Oak (<i>Quercus garryana</i>)	OFFSITE; Evaluated from property line; Lean (W)	1	2	Preserve
12212	9	7	Douglas-fir (<i>Pseudotsuga menziesii</i>)		1	1	Remove
12216	20	22	Oregon White Oak (<i>Quercus garryana</i>)		1	1	Remove
12217	8	9	Douglas-fir (<i>Pseudotsuga menziesii</i>)		1	1	Remove
12221	28	14	Douglas-fir (<i>Pseudotsuga menziesii</i>)	Sweep (E)	1	2	Remove
12223	28	18	Douglas-fir (<i>Pseudotsuga menziesii</i>)	Sweep (E); 1-sided canopy (W)	1	2	Remove
12225	12	14	Douglas-fir (<i>Pseudotsuga menziesii</i>)	1-sided canopy (E)	1	2	Remove
12226	14	0	Douglas-fir (<i>Pseudotsuga menziesii</i>)	Dead; Broken at 15'	3	3	Remove
12230	8	8	Douglas-fir (<i>Pseudotsuga menziesii</i>)		1	1	Remove
12231	9	6	Douglas-fir (<i>Pseudotsuga menziesii</i>)		1	1	Remove
12235	8	7	Douglas-fir (<i>Pseudotsuga menziesii</i>)		1	1	Remove
12236	9	9	Douglas-fir (<i>Pseudotsuga menziesii</i>)		1	1	Remove
12238	29	18	Douglas-fir (<i>Pseudotsuga menziesii</i>)		1	1	Remove
12242	9	10	Douglas-fir (<i>Pseudotsuga menziesii</i>)	1-sided canopy (SW)	1	2	Remove
12244	29	20	Douglas-fir (<i>Pseudotsuga menziesii</i>)		1	1	Remove
12245	17	15	Douglas-fir (<i>Pseudotsuga menziesii</i>)	Crooked bole	1	2	Remove
12248	25	18	Douglas-fir (<i>Pseudotsuga menziesii</i>)		1	1	Remove
12251	24	15	Douglas-fir (<i>Pseudotsuga menziesii</i>)		1	1	Remove
12253	26,8	19	Douglas-fir (<i>Pseudotsuga menziesii</i>)		1	1	Remove
12256	8	9	Douglas-fir (<i>Pseudotsuga menziesii</i>)		1	1	Remove
12260	9	5	Douglas-fir (<i>Pseudotsuga menziesii</i>)	High canopy	1	2	Remove
12262	14	10	Douglas-fir (<i>Pseudotsuga menziesii</i>)		1	1	Remove
12264	9	5	Douglas-fir (<i>Pseudotsuga menziesii</i>)	High canopy	1	2	Remove
12265	8	6	Douglas-fir (<i>Pseudotsuga menziesii</i>)	1-sided canopy (N)	1	2	Remove
12266	11	8	Douglas-fir (<i>Pseudotsuga menziesii</i>)		1	1	Remove
12267	9	9	Douglas-fir (<i>Pseudotsuga menziesii</i>)		1	1	Remove
12268	13	7	Douglas-fir (<i>Pseudotsuga menziesii</i>)		1	1	Remove
12270	11	0	Douglas-fir (<i>Pseudotsuga menziesii</i>)	Dead; Broken at 20'	3	3	Remove
12271	9	7	Douglas-fir (<i>Pseudotsuga menziesii</i>)	Broken top; 1-sided canopy (S)	2	3	Remove
12272	10	8	Douglas-fir (<i>Pseudotsuga menziesii</i>)		1	1	Remove
12273	9	9	Douglas-fir (<i>Pseudotsuga menziesii</i>)	1-sided canopy (E)	1	2	Remove
12274	8	0	Douglas-fir (<i>Pseudotsuga menziesii</i>)	Dead; broken at 40'	3	3	Remove
12275	11	8	Douglas-fir (<i>Pseudotsuga menziesii</i>)		1	1	Remove
12277	12	12	Douglas-fir (<i>Pseudotsuga menziesii</i>)	Codominant top; 1-sided canopy (E)	1	2	Remove
12278	10	7	Douglas-fir (<i>Pseudotsuga menziesii</i>)	1-sided canopy (S)	1	2	Remove
12279	10	9	Douglas-fir (<i>Pseudotsuga menziesii</i>)		1	1	Remove
12280	9	5	Douglas-fir (<i>Pseudotsuga menziesii</i>)	High canopy	1	2	Remove
12281	10	6	Douglas-fir (<i>Pseudotsuga menziesii</i>)		1	1	Remove
12282	11	8	Douglas-fir (<i>Pseudotsuga menziesii</i>)		1	1	Remove
12283	10	6	Douglas-fir (<i>Pseudotsuga menziesii</i>)		1	1	Remove
12284	9	9	Douglas-fir (<i>Pseudotsuga menziesii</i>)		1	1	Remove
12285	11	15	Douglas-fir (<i>Pseudotsuga menziesii</i>)	2-sided canopy (S)	1	2	Remove
12288	8	7	Douglas-fir (<i>Pseudotsuga menziesii</i>)		1	1	Remove
12289	11	12	Douglas-fir (<i>Pseudotsuga menziesii</i>)	Broken top; 1-sided canopy (S)	2	3	Remove
12290	11	6	Douglas-fir (<i>Pseudotsuga menziesii</i>)	High canopy	1	2	Remove
12292	9	7	Douglas-fir (<i>Pseudotsuga menziesii</i>)		1	1	Remove
12295	11	8	Douglas-fir (<i>Pseudotsuga menziesii</i>)		1	1	Remove
12296	12	9	Douglas-fir (<i>Pseudotsuga menziesii</i>)		1	1	Remove
12301	8	5	Douglas-fir (<i>Pseudotsuga menziesii</i>)		1	1	Remove
12303	9	6	Douglas-fir (<i>Pseudotsuga menziesii</i>)	High canopy	1	2	Remove
12304	8	7	Douglas-fir (<i>Pseudotsuga menziesii</i>)		1	1	Remove
12308	11	9	Douglas-fir (<i>Pseudotsuga menziesii</i>)		1	1	Remove
12309	9	7	Douglas-fir (<i>Pseudotsuga menziesii</i>)		1	1	Remove
12314	8	8	Douglas-fir (<i>Pseudotsuga menziesii</i>)		1	1	Remove
12315	10	5	Douglas-fir (<i>Pseudotsuga menziesii</i>)	Broken top; Dead branches	2	3	Remove
12316	8	6	Douglas-fir (<i>Pseudotsuga menziesii</i>)	Broken top; Sparse canopy	2	3	Remove
12325	10	7	Douglas-fir (<i>Pseudotsuga menziesii</i>)		1	1	Remove
12328	9	0	Douglas-fir (<i>Pseudotsuga menziesii</i>)	Dead	3	3	Remove
12329	8	7	Douglas-fir (<i>Pseudotsuga menziesii</i>)		1	1	Remove
12330	8	5	Douglas-fir (<i>Pseudotsuga menziesii</i>)	Sparse canopy	2	2	Remove
12335	8	7	Douglas-fir (<i>Pseudotsuga menziesii</i>)	Broken top; Sparse canopy	2	3	Remove
12337	9	8	Douglas-fir (<i>Pseudotsuga menziesii</i>)		1	1	Remove
12338	10	10	Douglas-fir (<i>Pseudotsuga menziesii</i>)	1-sided canopy (W)	1	2	Remove

Detailed Tree Inventory for Autumn Sunrise

AKS Job No. 7454 - Evaluation Date: 2/1/2021 - 4/12/2021 - Evaluated by: BRK

Tree #	DBH (in.)	Avg. Crown Radius (ft)	Tree Species Common Name (<i>Scientific name</i>)	Comments	Health Rating*	Structure Rating**	Remove/Preserve
12339	8	5	Douglas-fir (<i>Pseudotsuga menziesii</i>)	High canopy	1	2	Remove
12340	11	7	Douglas-fir (<i>Pseudotsuga menziesii</i>)		1	1	Remove
12341	8	6	Douglas-fir (<i>Pseudotsuga menziesii</i>)		1	1	Remove
12342	8	5	Douglas-fir (<i>Pseudotsuga menziesii</i>)	Broken top; Sparse canopy	2	3	Remove
12343	8	4	Douglas-fir (<i>Pseudotsuga menziesii</i>)	High canopy	1	2	Remove
12344	8	4	Douglas-fir (<i>Pseudotsuga menziesii</i>)	Broken top; Sparse canopy	2	3	Remove
12346	27	21	Douglas-fir (<i>Pseudotsuga menziesii</i>)	Sweep (W)	1	2	Remove
12350	40	21	Douglas-fir (<i>Pseudotsuga menziesii</i>)		1	1	Remove
12352	10	8	Douglas-fir (<i>Pseudotsuga menziesii</i>)		1	1	Remove
12353	8	6	Douglas-fir (<i>Pseudotsuga menziesii</i>)		1	1	Remove
12354	12	8	Douglas-fir (<i>Pseudotsuga menziesii</i>)		1	1	Remove
12355	8	6	Douglas-fir (<i>Pseudotsuga menziesii</i>)		1	1	Remove
12357	10	6	Douglas-fir (<i>Pseudotsuga menziesii</i>)		1	1	Remove
12358	13	10	Douglas-fir (<i>Pseudotsuga menziesii</i>)	1-sided canopy (S)	1	2	Remove
12359	9	10	Douglas-fir (<i>Pseudotsuga menziesii</i>)	1-sided canopy (S)	1	2	Remove
12363	13	13	Douglas-fir (<i>Pseudotsuga menziesii</i>)		1	1	Remove
12364	10	6	Douglas-fir (<i>Pseudotsuga menziesii</i>)		1	1	Remove
12365	9	0	Douglas-fir (<i>Pseudotsuga menziesii</i>)	Dead; Broken at 40'	3	3	Remove
12366	11	7	Douglas-fir (<i>Pseudotsuga menziesii</i>)		1	1	Remove
12368	11	10	Douglas-fir (<i>Pseudotsuga menziesii</i>)	1-sided canopy (S)	1	2	Remove
12369	9	11	Douglas-fir (<i>Pseudotsuga menziesii</i>)		1	1	Remove
12371	8	6	Douglas-fir (<i>Pseudotsuga menziesii</i>)	Broken top; Sparse canopy	2	3	Remove
12373	9	6	Douglas-fir (<i>Pseudotsuga menziesii</i>)	Broken top; Sparse canopy	2	3	Remove
12374	8	6	Douglas-fir (<i>Pseudotsuga menziesii</i>)	High canopy	1	2	Remove
12375	8	7	Douglas-fir (<i>Pseudotsuga menziesii</i>)	Crooked bole	1	2	Remove
12377	18	10	Douglas-fir (<i>Pseudotsuga menziesii</i>)		1	1	Remove
12380	8	4	Douglas-fir (<i>Pseudotsuga menziesii</i>)		1	1	Remove
12382	13	15	Douglas-fir (<i>Pseudotsuga menziesii</i>)	1-sided canopy (S)	1	2	Remove
12383	10	6	Douglas-fir (<i>Pseudotsuga menziesii</i>)	1-sided canopy (S)	1	2	Remove
12384	10	0	Douglas-fir (<i>Pseudotsuga menziesii</i>)	Dead; Broken at 50'	3	3	Remove
12385	10,11	7	Willow (<i>Salix sp.</i>)	Epicormic Sprouts; Dead branches	2	1	Remove
12386	8	14	Douglas-fir (<i>Pseudotsuga menziesii</i>)	Suppressed; 1-sided canopy (W)	2	2	Remove
12387	16	16	Douglas-fir (<i>Pseudotsuga menziesii</i>)	Deformed bole	1	2	Remove
12388	16	18	Douglas-fir (<i>Pseudotsuga menziesii</i>)	Deformed bole; Dead limbs	2	2	Remove
12389	22	19	Douglas-fir (<i>Pseudotsuga menziesii</i>)	1-sided canopy (W)	1	2	Remove
12391	23	20	Douglas-fir (<i>Pseudotsuga menziesii</i>)		1	1	Remove
12396	35	25	Douglas-fir (<i>Pseudotsuga menziesii</i>)	Dead branches; Sparse canopy	2	2	Remove
12398	29	21	Douglas-fir (<i>Pseudotsuga menziesii</i>)	1-sided canopy (W)	1	2	Remove
12400	19	18	Douglas-fir (<i>Pseudotsuga menziesii</i>)		1	1	Remove
12401	28	18	Douglas-fir (<i>Pseudotsuga menziesii</i>)		1	1	Remove
12404	14	14	Douglas-fir (<i>Pseudotsuga menziesii</i>)		1	1	Remove
12405	45	25	Douglas-fir (<i>Pseudotsuga menziesii</i>)	1-sided canopy (E)	1	2	Remove
12407	15	11	Douglas-fir (<i>Pseudotsuga menziesii</i>)	1-sided canopy (S)	1	2	Remove
12413	26	19	Douglas-fir (<i>Pseudotsuga menziesii</i>)		1	1	Remove
12414	25,7	18	Douglas-fir (<i>Pseudotsuga menziesii</i>)	1-sided canopy (S)	1	2	Remove
12415	29	19	Douglas-fir (<i>Pseudotsuga menziesii</i>)		1	1	Remove
12416	8	4	Douglas-fir (<i>Pseudotsuga menziesii</i>)	Broken top; Sparse canopy	2	3	Remove
12417	8	6	Douglas-fir (<i>Pseudotsuga menziesii</i>)		1	1	Remove
12418	23	13	Douglas-fir (<i>Pseudotsuga menziesii</i>)	Crooked bole; 1-sided canopy (S)	1	2	Remove
12419	9	5	Douglas-fir (<i>Pseudotsuga menziesii</i>)		1	1	Remove
12420	11	7	Douglas-fir (<i>Pseudotsuga menziesii</i>)		1	1	Remove
12421	10	8	Douglas-fir (<i>Pseudotsuga menziesii</i>)		1	1	Remove
12427	8	7	Douglas-fir (<i>Pseudotsuga menziesii</i>)		1	1	Remove
12433	8	6	Douglas-fir (<i>Pseudotsuga menziesii</i>)		1	1	Remove
12434	10	4	Douglas-fir (<i>Pseudotsuga menziesii</i>)	High canopy	1	2	Remove
12435	9	15	Douglas-fir (<i>Pseudotsuga menziesii</i>)	Broken top; 1-sided canopy (S)	2	3	Remove
12436	9	0	Douglas-fir (<i>Pseudotsuga menziesii</i>)	Dead; Broken at 40'	3	3	Remove
12441	9	9	Douglas-fir (<i>Pseudotsuga menziesii</i>)	Broken top	2	3	Remove
12444	12	8	Douglas-fir (<i>Pseudotsuga menziesii</i>)	1-sided canopy (S)	1	2	Remove
12445	8	0	Douglas-fir (<i>Pseudotsuga menziesii</i>)	Dead; Broken at 40'	3	3	Remove
12446	9	7	Douglas-fir (<i>Pseudotsuga menziesii</i>)	1-sided canopy (E)	1	2	Remove
12447	10	7	Douglas-fir (<i>Pseudotsuga menziesii</i>)	1-sided canopy (S)	1	2	Remove
12449	9	7	Douglas-fir (<i>Pseudotsuga menziesii</i>)		1	1	Remove
12452	8	0	Douglas-fir (<i>Pseudotsuga menziesii</i>)	Broken top	2	3	Remove
12454	9	6	Douglas-fir (<i>Pseudotsuga menziesii</i>)	Broken top; Sparse canopy	2	3	Remove
12456	29	20	Douglas-fir (<i>Pseudotsuga menziesii</i>)	Codominant with included bark	1	2	Remove
12457	12	8	Douglas-fir (<i>Pseudotsuga menziesii</i>)		1	1	Remove
12459	12	10	Douglas-fir (<i>Pseudotsuga menziesii</i>)		1	1	Remove
12460	10	10	Douglas-fir (<i>Pseudotsuga menziesii</i>)		1	1	Remove

Detailed Tree Inventory for Autumn Sunrise

AKS Job No. 7454 - Evaluation Date: 2/1/2021 - 4/12/2021 - Evaluated by: BRK

Tree #	DBH (in.)	Avg. Crown Radius (ft)	Tree Species Common Name (<i>Scientific name</i>)	Comments	Health Rating*	Structure Rating**	Remove/Preserve
12461	9	10	Douglas-fir (<i>Pseudotsuga menziesii</i>)	1-sided canopy (N)	1	2	Remove
12462	8	6	Douglas-fir (<i>Pseudotsuga menziesii</i>)	1-sided canopy (N)	1	2	Remove
12464	8	8	Douglas-fir (<i>Pseudotsuga menziesii</i>)		1	1	Remove
12465	12	9	Douglas-fir (<i>Pseudotsuga menziesii</i>)		1	1	Remove
12466	8	0	Douglas-fir (<i>Pseudotsuga menziesii</i>)	Dead; Broken at 30'	3	3	Remove
12467	9	7	Douglas-fir (<i>Pseudotsuga menziesii</i>)		1	1	Remove
12469	8	6	Douglas-fir (<i>Pseudotsuga menziesii</i>)		1	1	Remove
12470	11	12	Douglas-fir (<i>Pseudotsuga menziesii</i>)		1	1	Remove
12471	12	8	Douglas-fir (<i>Pseudotsuga menziesii</i>)		1	1	Remove
12472	8	7	Douglas-fir (<i>Pseudotsuga menziesii</i>)	High canopy	1	2	Remove
12473	11	7	Douglas-fir (<i>Pseudotsuga menziesii</i>)		1	1	Remove
12475	8	8	Douglas-fir (<i>Pseudotsuga menziesii</i>)	Broken top; Sparse canopy	2	3	Remove
12476	8	0	Douglas-fir (<i>Pseudotsuga menziesii</i>)	Dead; Broken at 40'	3	3	Remove
12477	13	13	Douglas-fir (<i>Pseudotsuga menziesii</i>)		1	1	Remove
12480	11	10	Douglas-fir (<i>Pseudotsuga menziesii</i>)		1	1	Remove
12481	12	11	Douglas-fir (<i>Pseudotsuga menziesii</i>)		1	1	Remove
12482	10	10	Douglas-fir (<i>Pseudotsuga menziesii</i>)		1	1	Remove
12483	11	9	Douglas-fir (<i>Pseudotsuga menziesii</i>)		1	1	Remove
12486	13	10	Douglas-fir (<i>Pseudotsuga menziesii</i>)	1-sided canopy (S)	1	2	Remove
12487	10	6	Douglas-fir (<i>Pseudotsuga menziesii</i>)	Broken top; Sparse canopy	2	3	Remove
12488	11	0	Douglas-fir (<i>Pseudotsuga menziesii</i>)		1	1	Remove
12489	12	10	Douglas-fir (<i>Pseudotsuga menziesii</i>)	1-sided canopy (S)	1	2	Remove
12490	10	8	Douglas-fir (<i>Pseudotsuga menziesii</i>)		1	1	Remove
12491	9	8	Douglas-fir (<i>Pseudotsuga menziesii</i>)		1	1	Remove
12492	8	8	Douglas-fir (<i>Pseudotsuga menziesii</i>)		1	1	Remove
12495	8	6	Douglas-fir (<i>Pseudotsuga menziesii</i>)	High canopy	1	2	Remove
12499	12	10	Douglas-fir (<i>Pseudotsuga menziesii</i>)		1	1	Remove
12502	9	5	Douglas-fir (<i>Pseudotsuga menziesii</i>)	High canopy	1	2	Remove
12505	31	25	Douglas-fir (<i>Pseudotsuga menziesii</i>)		1	1	Remove
12508	11	7	Douglas-fir (<i>Pseudotsuga menziesii</i>)		1	1	Remove
12513	9	6	Douglas-fir (<i>Pseudotsuga menziesii</i>)	High canopy	1	2	Remove
12517	7,9	6	Willow (<i>Salix sp.</i>)	Dead limbs	2	1	Remove
12518	12	13	Douglas-fir (<i>Pseudotsuga menziesii</i>)	1-sided canopy (E)	1	2	Remove
12519	8	6	Douglas-fir (<i>Pseudotsuga menziesii</i>)	1-sided canopy (E)	1	2	Remove
12520	9	6	Douglas-fir (<i>Pseudotsuga menziesii</i>)		1	1	Remove
12521	12	10	Douglas-fir (<i>Pseudotsuga menziesii</i>)		1	1	Remove
12522	11	11	Douglas-fir (<i>Pseudotsuga menziesii</i>)	1-sided canopy (S)	1	2	Remove
12524	9	6	Douglas-fir (<i>Pseudotsuga menziesii</i>)		1	1	Remove
12525	9	9	Douglas-fir (<i>Pseudotsuga menziesii</i>)		1	1	Remove
12526	9	4	Douglas-fir (<i>Pseudotsuga menziesii</i>)	High canopy	1	2	Remove
12527	12	9	Douglas-fir (<i>Pseudotsuga menziesii</i>)		1	1	Remove
12528	12	14	Douglas-fir (<i>Pseudotsuga menziesii</i>)		1	1	Remove
12530	10	5	Douglas-fir (<i>Pseudotsuga menziesii</i>)		1	1	Remove
12531	10	7	Douglas-fir (<i>Pseudotsuga menziesii</i>)		1	1	Remove
12532	11	9	Douglas-fir (<i>Pseudotsuga menziesii</i>)		1	1	Remove
12534	10	6	Douglas-fir (<i>Pseudotsuga menziesii</i>)		1	1	Remove
12535	21	15	Douglas-fir (<i>Pseudotsuga menziesii</i>)	1-sided canopy (S)	1	2	Remove
12536	26	17	Douglas-fir (<i>Pseudotsuga menziesii</i>)		1	1	Remove
12541	16	16	Douglas-fir (<i>Pseudotsuga menziesii</i>)	1-sided canopy (E)	1	2	Remove
12542	23	15	Douglas-fir (<i>Pseudotsuga menziesii</i>)	Sweep	1	2	Remove
12543	26	21	Douglas-fir (<i>Pseudotsuga menziesii</i>)	1-sided canopy (W)	1	2	Remove
12545	8,9,11	8	Willow (<i>Salix sp.</i>)	Dead limbs	2	1	Remove
12549	8	6	Douglas-fir (<i>Pseudotsuga menziesii</i>)	High canopy	1	2	Remove
12552	13	9	Douglas-fir (<i>Pseudotsuga menziesii</i>)		1	1	Remove
12556	8	7	Douglas-fir (<i>Pseudotsuga menziesii</i>)	1-sided canopy (W)	1	2	Remove
12568	28	16	Douglas-fir (<i>Pseudotsuga menziesii</i>)		1	1	Remove
12581	8	6	Douglas-fir (<i>Pseudotsuga menziesii</i>)	Significant lean (S); Uprooting	2	3	Remove
12583	11	9	Douglas-fir (<i>Pseudotsuga menziesii</i>)		1	1	Remove
12585	8	6	Douglas-fir (<i>Pseudotsuga menziesii</i>)		1	1	Remove
12586	15	12	Douglas-fir (<i>Pseudotsuga menziesii</i>)	1-sided canopy (W)	1	2	Remove
12587	9	6	Douglas-fir (<i>Pseudotsuga menziesii</i>)	Broken top; Sparse canopy	2	3	Remove
12588	9	0	Douglas-fir (<i>Pseudotsuga menziesii</i>)	Dead; Broken at 40'	3	3	Remove
12589	10	0	Douglas-fir (<i>Pseudotsuga menziesii</i>)	Dead; Broken at 20'	3	3	Remove
12590	11	6	Douglas-fir (<i>Pseudotsuga menziesii</i>)	High canopy	1	2	Remove
12592	11	7	Douglas-fir (<i>Pseudotsuga menziesii</i>)	1-sided canopy (S)	1	2	Remove
12593	9	7	Douglas-fir (<i>Pseudotsuga menziesii</i>)	1-sided canopy (E)	1	2	Remove
12594	8	10	Douglas-fir (<i>Pseudotsuga menziesii</i>)	Epicormic Sprouts; 1-sided canopy (W)	2	2	Remove
12595	10	8	Douglas-fir (<i>Pseudotsuga menziesii</i>)	Broken top	2	3	Remove
12598	8	9	Douglas-fir (<i>Pseudotsuga menziesii</i>)		1	1	Remove

Detailed Tree Inventory for Autumn Sunrise

AKS Job No. 7454 - Evaluation Date: 2/1/2021 - 4/12/2021 - Evaluated by: BRK

Tree #	DBH (in.)	Avg. Crown Radius (ft)	Tree Species Common Name (Scientific name)	Comments	Health Rating*	Structure Rating**	Remove/Preserve
12599	11	8	Douglas-fir (<i>Pseudotsuga menziesii</i>)	Broken top; Sparse canopy	2	3	Remove
12600	8	0	Douglas-fir (<i>Pseudotsuga menziesii</i>)	Dead; broken at 50'	3	3	Remove
12602	10	8	Douglas-fir (<i>Pseudotsuga menziesii</i>)	1-sided canopy (W)	1	2	Remove
12603	11	9	Douglas-fir (<i>Pseudotsuga menziesii</i>)		1	1	Remove
12604	12	7	Douglas-fir (<i>Pseudotsuga menziesii</i>)	1-sided canopy (W)	1	2	Remove
12607	15	12	Douglas-fir (<i>Pseudotsuga menziesii</i>)		1	1	Remove
12608	10	9	Douglas-fir (<i>Pseudotsuga menziesii</i>)	Broken top	2	3	Remove
12609	9	10	Douglas-fir (<i>Pseudotsuga menziesii</i>)	Broken at very top; 1-sided canopy (W)	2	2	Remove
12610	9	5	Douglas-fir (<i>Pseudotsuga menziesii</i>)	High canopy	1	2	Remove
12612	12	9	Douglas-fir (<i>Pseudotsuga menziesii</i>)		1	1	Remove
12615	8	9	Douglas-fir (<i>Pseudotsuga menziesii</i>)	Top lean (S)	1	2	Remove
12616	10	0	Douglas-fir (<i>Pseudotsuga menziesii</i>)	Dead; Broken at 40'	3	3	Remove
12617	11	8	Douglas-fir (<i>Pseudotsuga menziesii</i>)		1	1	Remove
12619	9	7	Douglas-fir (<i>Pseudotsuga menziesii</i>)		1	1	Remove
12620	8	8	Douglas-fir (<i>Pseudotsuga menziesii</i>)		1	1	Remove
12621	8	6	Douglas-fir (<i>Pseudotsuga menziesii</i>)	Suppressed; Sparse canopy	2	2	Remove
12622	10	8	Douglas-fir (<i>Pseudotsuga menziesii</i>)		1	1	Remove
12623	10	7	Douglas-fir (<i>Pseudotsuga menziesii</i>)	1-sided canopy (E)	1	2	Remove
12626	14	12	Douglas-fir (<i>Pseudotsuga menziesii</i>)		1	1	Remove
12628	8	0	Douglas-fir (<i>Pseudotsuga menziesii</i>)	Dead; Broken at 20'	3	3	Remove
12629	9	9	Douglas-fir (<i>Pseudotsuga menziesii</i>)	1-sided canopy (E)	1	2	Remove
12630	12	10	Douglas-fir (<i>Pseudotsuga menziesii</i>)		1	1	Remove
12632	9	9	Douglas-fir (<i>Pseudotsuga menziesii</i>)	1-sided canopy (N)	1	2	Remove
12633	10	8	Douglas-fir (<i>Pseudotsuga menziesii</i>)		1	1	Remove
12634	9	5	Douglas-fir (<i>Pseudotsuga menziesii</i>)		1	1	Remove
12635	8	6	Douglas-fir (<i>Pseudotsuga menziesii</i>)	Broken top; Sparse canopy	2	3	Remove
12637	8	6	Douglas-fir (<i>Pseudotsuga menziesii</i>)	Broken top; Sparse canopy	2	3	Remove
12638	10	8	Douglas-fir (<i>Pseudotsuga menziesii</i>)		1	1	Remove
12639	8,6	0	Willow (<i>Salix sp.</i>)	Dead; Broken tops	3	3	Remove
12641	13	10	Douglas-fir (<i>Pseudotsuga menziesii</i>)		1	1	Remove
12643	12	8	Douglas-fir (<i>Pseudotsuga menziesii</i>)		1	1	Remove
12644	12	9	Douglas-fir (<i>Pseudotsuga menziesii</i>)	1-sided canopy (W)	1	2	Remove
12645	8	6	Douglas-fir (<i>Pseudotsuga menziesii</i>)	Broken top; Sparse canopy	2	3	Remove
12646	11	8	Douglas-fir (<i>Pseudotsuga menziesii</i>)		1	1	Remove
12647	9	6	Douglas-fir (<i>Pseudotsuga menziesii</i>)		1	1	Remove
12648	11,11	11	Douglas-fir (<i>Pseudotsuga menziesii</i>)	Codominant base with included bark	1	2	Remove
12649	10	7	Douglas-fir (<i>Pseudotsuga menziesii</i>)		1	1	Remove
12653	12	9	Douglas-fir (<i>Pseudotsuga menziesii</i>)	1-sided canopy (N)	1	2	Remove
12654	11	10	Douglas-fir (<i>Pseudotsuga menziesii</i>)		1	1	Remove
12655	9	3	Douglas-fir (<i>Pseudotsuga menziesii</i>)	High canopy	1	2	Remove
12656	10,12	10	Douglas-fir (<i>Pseudotsuga menziesii</i>)	Codominant base with included bark	1	2	Remove
12658	11	9	Douglas-fir (<i>Pseudotsuga menziesii</i>)		1	1	Remove
12659	10	11	Douglas-fir (<i>Pseudotsuga menziesii</i>)		1	1	Remove
12660	10	9	Douglas-fir (<i>Pseudotsuga menziesii</i>)		1	1	Remove
12661	11	11	Douglas-fir (<i>Pseudotsuga menziesii</i>)	1-sided canopy (W)	1	2	Remove
12662	14	15	Douglas-fir (<i>Pseudotsuga menziesii</i>)	Sweep	1	2	Remove
12663	11	10	Douglas-fir (<i>Pseudotsuga menziesii</i>)		1	1	Remove
12665	14	14	Douglas-fir (<i>Pseudotsuga menziesii</i>)	1-sided canopy (W)	1	2	Remove
12668	10	8	Douglas-fir (<i>Pseudotsuga menziesii</i>)		1	1	Remove
12669	8	5	Douglas-fir (<i>Pseudotsuga menziesii</i>)	Broken top; Sparse canopy	2	3	Remove
12670	9	0	Douglas-fir (<i>Pseudotsuga menziesii</i>)	Dead; Broken at 40'	3	3	Remove
12671	9	7	Douglas-fir (<i>Pseudotsuga menziesii</i>)	Broken top; Sparse canopy	2	3	Remove
12672	22	18	Douglas-fir (<i>Pseudotsuga menziesii</i>)		1	1	Remove
12674	9	7	Douglas-fir (<i>Pseudotsuga menziesii</i>)	1-sided canopy (W)	1	2	Remove
12676	8	5	Douglas-fir (<i>Pseudotsuga menziesii</i>)	Broken top; Sparse canopy	2	3	Remove
12677	9	0	Douglas-fir (<i>Pseudotsuga menziesii</i>)	Dead; Broken at 40'	3	3	Remove
12678	9	0	Douglas-fir (<i>Pseudotsuga menziesii</i>)	Dead; Broken at 40'	3	3	Remove
12680	11	5	Douglas-fir (<i>Pseudotsuga menziesii</i>)	High canopy	1	2	Remove
12682	14	12	Douglas-fir (<i>Pseudotsuga menziesii</i>)	1-sided canopy (W)	1	2	Remove
12683	12	10	Douglas-fir (<i>Pseudotsuga menziesii</i>)		1	1	Remove
12684	13	9	Douglas-fir (<i>Pseudotsuga menziesii</i>)		1	1	Remove
12685	8	9	Douglas-fir (<i>Pseudotsuga menziesii</i>)	Broken top	2	3	Remove
12692	10	12	Douglas-fir (<i>Pseudotsuga menziesii</i>)	1-sided canopy (W)	1	2	Remove
12693	10	10	Douglas-fir (<i>Pseudotsuga menziesii</i>)		1	1	Remove
12695	27	23	Douglas-fir (<i>Pseudotsuga menziesii</i>)		1	1	Remove
12696	21	20	Douglas-fir (<i>Pseudotsuga menziesii</i>)	1-sided canopy (E)	1	2	Remove
12699	10	9	Douglas-fir (<i>Pseudotsuga menziesii</i>)		1	1	Remove
12700	12	8	Douglas-fir (<i>Pseudotsuga menziesii</i>)		1	1	Remove
12701	9	0	Douglas-fir (<i>Pseudotsuga menziesii</i>)	Dead; Broken at 40'	3	3	Remove

Detailed Tree Inventory for Autumn Sunrise

AKS Job No. 7454 - Evaluation Date: 2/1/2021 - 4/12/2021 - Evaluated by: BRK

Tree #	DBH (in.)	Avg. Crown Radius (ft)	Tree Species Common Name (<i>Scientific name</i>)	Comments	Health Rating*	Structure Rating**	Remove/Preserve
12702	11	9	Douglas-fir (<i>Pseudotsuga menziesii</i>)		1	1	Remove
12704	8	4	Douglas-fir (<i>Pseudotsuga menziesii</i>)	High canopy	1	2	Remove
12705	12	14	Douglas-fir (<i>Pseudotsuga menziesii</i>)	1-sided canopy (W)	1	2	Remove
12706	8	6	Douglas-fir (<i>Pseudotsuga menziesii</i>)		1	1	Remove
12707	12	7	Douglas-fir (<i>Pseudotsuga menziesii</i>)		1	1	Remove
12708	8	0	Douglas-fir (<i>Pseudotsuga menziesii</i>)	Dead; Broken at 40'	3	3	Remove
12709	8	6	Douglas-fir (<i>Pseudotsuga menziesii</i>)		1	1	Remove
12710	11	8	Douglas-fir (<i>Pseudotsuga menziesii</i>)		1	1	Remove
12711	10	6	Douglas-fir (<i>Pseudotsuga menziesii</i>)		1	1	Remove
12712	10	6	Douglas-fir (<i>Pseudotsuga menziesii</i>)		1	1	Remove
12713	10	6	Douglas-fir (<i>Pseudotsuga menziesii</i>)		1	1	Remove
12714	12	9	Douglas-fir (<i>Pseudotsuga menziesii</i>)		1	1	Remove
12716	9	6	Douglas-fir (<i>Pseudotsuga menziesii</i>)		1	1	Remove
12717	10	6	Douglas-fir (<i>Pseudotsuga menziesii</i>)		1	1	Remove
12719	9	8	Douglas-fir (<i>Pseudotsuga menziesii</i>)		1	1	Remove
12720	8	6	Douglas-fir (<i>Pseudotsuga menziesii</i>)		1	1	Remove
12721	11	7	Douglas-fir (<i>Pseudotsuga menziesii</i>)		1	1	Remove
12723	13	10	Douglas-fir (<i>Pseudotsuga menziesii</i>)		1	1	Remove
12724	11	9	Douglas-fir (<i>Pseudotsuga menziesii</i>)		1	1	Remove
12727	9	7	Douglas-fir (<i>Pseudotsuga menziesii</i>)		1	1	Remove
12728	11	8	Douglas-fir (<i>Pseudotsuga menziesii</i>)		1	1	Remove
12729	10	8	Douglas-fir (<i>Pseudotsuga menziesii</i>)		1	1	Remove
12730	10	8	Douglas-fir (<i>Pseudotsuga menziesii</i>)		1	1	Remove
12731	9	4	Douglas-fir (<i>Pseudotsuga menziesii</i>)	Broken top; Sparse canopy	2	3	Remove
12733	10	9	Douglas-fir (<i>Pseudotsuga menziesii</i>)		1	1	Remove
12734	10	6	Douglas-fir (<i>Pseudotsuga menziesii</i>)		1	1	Remove
12735	10,8	6	Douglas-fir (<i>Pseudotsuga menziesii</i>)	Broken top; Sparse canopy	2	3	Remove
12736	8	6	Douglas-fir (<i>Pseudotsuga menziesii</i>)	High canopy	1	2	Remove
12737	10	7	Douglas-fir (<i>Pseudotsuga menziesii</i>)	1-sided canopy (S)	1	2	Remove
12739	9	7	Douglas-fir (<i>Pseudotsuga menziesii</i>)	Broken top	2	3	Remove
12740	9	7	Douglas-fir (<i>Pseudotsuga menziesii</i>)		1	1	Remove
12741	10	8	Douglas-fir (<i>Pseudotsuga menziesii</i>)		1	1	Remove
12743	9	7	Douglas-fir (<i>Pseudotsuga menziesii</i>)		1	1	Remove
12748	9	6	Douglas-fir (<i>Pseudotsuga menziesii</i>)	High canopy	1	2	Remove
12751	8	6	Douglas-fir (<i>Pseudotsuga menziesii</i>)	High canopy	1	2	Remove
12752	8	8	Douglas-fir (<i>Pseudotsuga menziesii</i>)	1-sided canopy (S)	1	2	Remove
12755	10	14	Douglas-fir (<i>Pseudotsuga menziesii</i>)		1	1	Remove
12758	14	15	Douglas-fir (<i>Pseudotsuga menziesii</i>)	1-sided canopy (S)	1	2	Remove
12761	8,6	15	Bigleaf Maple (<i>Acer macrophyllum</i>)	Tops lean (W)	1	2	Remove
12763	8	7	Douglas-fir (<i>Pseudotsuga menziesii</i>)		1	1	Remove
12764	8	7	Douglas-fir (<i>Pseudotsuga menziesii</i>)		1	1	Remove
12765	9	0	Douglas-fir (<i>Pseudotsuga menziesii</i>)	Dead; Broken at 40'	3	3	Remove
12766	12	11	Douglas-fir (<i>Pseudotsuga menziesii</i>)	1-sided canopy (S)	1	2	Remove
12770	8	0	Douglas-fir (<i>Pseudotsuga menziesii</i>)	Dead; Broken at 40'	3	3	Remove
12771	9	8	Douglas-fir (<i>Pseudotsuga menziesii</i>)	High canopy	1	2	Remove
12772	9	8	Douglas-fir (<i>Pseudotsuga menziesii</i>)		1	1	Remove
12777	8	0	Douglas-fir (<i>Pseudotsuga menziesii</i>)	Dead	3	3	Remove
12780	10,11	18	Oregon White Oak (<i>Quercus garryana</i>)	Lean (W); Codominant base	1	2	Remove
12781	12	13	Oregon White Oak (<i>Quercus garryana</i>)	OFFSITE; Evaluated from property line	1	1	Preserve
12785	21	14	Douglas-fir (<i>Pseudotsuga menziesii</i>)	OFFSITE; Evaluated from property line	1	1	Remove
12790	8	0	Douglas-fir (<i>Pseudotsuga menziesii</i>)	Dead	3	3	Remove
12792	8	6	Douglas-fir (<i>Pseudotsuga menziesii</i>)	High canopy; 1-sided canopy (E)	1	2	Remove
12793	15	12	Oregon White Oak (<i>Quercus garryana</i>)		1	1	Remove
12794	8	0	Douglas-fir (<i>Pseudotsuga menziesii</i>)	Dead; Broken at 30'	3	3	Remove
12796	8	7	Douglas-fir (<i>Pseudotsuga menziesii</i>)		1	1	Remove
12797	7,9,9,10,13	13	Bigleaf Maple (<i>Acer macrophyllum</i>)	Dead limbs; Codominant base with included bark	2	2	Remove
12799	8	7	Douglas-fir (<i>Pseudotsuga menziesii</i>)	High canopy	1	2	Remove
12800	8	9	Douglas-fir (<i>Pseudotsuga menziesii</i>)		1	1	Remove
12801	8	0	Douglas-fir (<i>Pseudotsuga menziesii</i>)	Dead; broken at 40'	3	3	Remove
12802	8	5	Douglas-fir (<i>Pseudotsuga menziesii</i>)	High canopy	1	2	Remove
12803	8	8	Douglas-fir (<i>Pseudotsuga menziesii</i>)		1	1	Remove
12804	10	14	Cherry (<i>Prunus sp.</i>)		1	1	Remove
12805	10	5	Douglas-fir (<i>Pseudotsuga menziesii</i>)	High canopy	1	2	Remove
12806	9,10	10	Douglas-fir (<i>Pseudotsuga menziesii</i>)	Codominant base; Broken tops	2	3	Remove
12809	8	4	Douglas-fir (<i>Pseudotsuga menziesii</i>)	High canopy	1	2	Remove
12813	10	8	Douglas-fir (<i>Pseudotsuga menziesii</i>)		1	1	Remove
12814	10	7	Douglas-fir (<i>Pseudotsuga menziesii</i>)		1	1	Remove
12815	10	7	Douglas-fir (<i>Pseudotsuga menziesii</i>)		1	1	Remove
12816	10	9	Douglas-fir (<i>Pseudotsuga menziesii</i>)		1	1	Remove

Detailed Tree Inventory for Autumn Sunrise

AKS Job No. 7454 - Evaluation Date: 2/1/2021 - 4/12/2021 - Evaluated by: BRK

Tree #	DBH (in.)	Avg. Crown Radius (ft)	Tree Species Common Name (Scientific name)	Comments	Health Rating*	Structure Rating**	Remove/Preserve
12817	11	9	Douglas-fir (<i>Pseudotsuga menziesii</i>)		1	1	Remove
12819	10	9	Douglas-fir (<i>Pseudotsuga menziesii</i>)		1	1	Remove
12820	12	11	Douglas-fir (<i>Pseudotsuga menziesii</i>)		1	1	Remove
12823	9	7	Douglas-fir (<i>Pseudotsuga menziesii</i>)		1	1	Remove
12829	10	9	Douglas-fir (<i>Pseudotsuga menziesii</i>)		1	1	Remove
12838	21	16	Douglas-fir (<i>Pseudotsuga menziesii</i>)	OFFSITE; Evaluated from property line; High canopy	1	2	Preserve
12840	23	16	Douglas-fir (<i>Pseudotsuga menziesii</i>)	OFFSITE; Evaluated from property line	1	1	Preserve
12844	26	15	Douglas-fir (<i>Pseudotsuga menziesii</i>)	OFFSITE; Evaluated from property line; High canopy; 1-sided canopy (N)	1	2	Remove
12846	24	15	Douglas-fir (<i>Pseudotsuga menziesii</i>)	OFFSITE; Evaluated from property line; 1-sided canopy (S)	1	2	Remove
12848	9,7	10	Oregon Ash (<i>Fraxinus latifolia</i>)	OFFSITE; Evaluated from property line; Codominant with included bark	1	2	Remove
12850	11	14	Douglas-fir (<i>Pseudotsuga menziesii</i>)		1	1	Remove
12851	12	10	Douglas-fir (<i>Pseudotsuga menziesii</i>)		1	1	Remove
12852	6	6	Cherry (<i>Prunus sp.</i>)	OFFSITE; Street Tree	1	1	Preserve
12853	9	7	Douglas-fir (<i>Pseudotsuga menziesii</i>)		1	1	Remove
12854	11	6	Douglas-fir (<i>Pseudotsuga menziesii</i>)		1	1	Remove
12855	10	7	Douglas-fir (<i>Pseudotsuga menziesii</i>)		1	1	Remove
12858	10	10	Douglas-fir (<i>Pseudotsuga menziesii</i>)		1	1	Remove
12861	9	7	Douglas-fir (<i>Pseudotsuga menziesii</i>)	High canopy	1	2	Remove
12862	10	9	Douglas-fir (<i>Pseudotsuga menziesii</i>)		1	1	Remove
12863	11	9	Douglas-fir (<i>Pseudotsuga menziesii</i>)		1	1	Remove
12864	11	7	Douglas-fir (<i>Pseudotsuga menziesii</i>)		1	1	Remove
12865	9	8	Willow (<i>Salix sp.</i>)	Broken top; Dead limbs; Sparse canopy	2	3	Remove
12867	9	8	Douglas-fir (<i>Pseudotsuga menziesii</i>)		1	1	Remove
12868	8	9	Douglas-fir (<i>Pseudotsuga menziesii</i>)	Sparse canopy	2	2	Remove
12869	15	15	Cherry (<i>Prunus sp.</i>)	Crooked; Many broken limbs	2	2	Remove
12871	8	7	Douglas-fir (<i>Pseudotsuga menziesii</i>)	1-sided canopy (S)	1	2	Remove
12873	12	7	Douglas-fir (<i>Pseudotsuga menziesii</i>)	Codominant top	1	2	Remove
12876	11	0	Douglas-fir (<i>Pseudotsuga menziesii</i>)	Dead; Broken at 30'	3	3	Remove
12878	9,8,7	18	Bigleaf Maple (<i>Acer macrophyllum</i>)	Broken limbs; Dead limbs; 1-sided canopy (N)	2	2	Remove
12880	14	13	Douglas-fir (<i>Pseudotsuga menziesii</i>)	1-sided canopy (S)	1	2	Remove
12881	12	12	Douglas-fir (<i>Pseudotsuga menziesii</i>)	1-sided canopy (E)	1	2	Remove
12883	12	9	Douglas-fir (<i>Pseudotsuga menziesii</i>)	1-sided canopy (S)	1	2	Remove
12884	8	6	Douglas-fir (<i>Pseudotsuga menziesii</i>)		1	1	Remove
12886	11	7	Douglas-fir (<i>Pseudotsuga menziesii</i>)		1	1	Remove
12887	10	6	Douglas-fir (<i>Pseudotsuga menziesii</i>)		1	1	Remove
12890	8	0	Willow (<i>Salix sp.</i>)	Dead; Lean (W)	3	3	Remove
12891	12	12	Douglas-fir (<i>Pseudotsuga menziesii</i>)		1	1	Remove
12893	9	7	Douglas-fir (<i>Pseudotsuga menziesii</i>)		1	1	Remove
12894	10	8	Douglas-fir (<i>Pseudotsuga menziesii</i>)		1	1	Remove
12895	8	6	Douglas-fir (<i>Pseudotsuga menziesii</i>)	High canopy	1	2	Remove
12896	12	13	Douglas-fir (<i>Pseudotsuga menziesii</i>)		1	1	Remove
12900	10	8	Douglas-fir (<i>Pseudotsuga menziesii</i>)		1	1	Remove
12901	10	6	Douglas-fir (<i>Pseudotsuga menziesii</i>)		1	1	Remove
12904	10	10	Douglas-fir (<i>Pseudotsuga menziesii</i>)		1	1	Remove
12905	8	5	Douglas-fir (<i>Pseudotsuga menziesii</i>)	Broken top; Sparse canopy	2	3	Remove
12908	8	3	Douglas-fir (<i>Pseudotsuga menziesii</i>)	High canopy	1	2	Remove
12910	10	6	Douglas-fir (<i>Pseudotsuga menziesii</i>)		1	1	Remove
12912	9	4	Douglas-fir (<i>Pseudotsuga menziesii</i>)	High canopy	1	2	Remove
12914	8	6	Douglas-fir (<i>Pseudotsuga menziesii</i>)		1	1	Remove
12918	8	2	Douglas-fir (<i>Pseudotsuga menziesii</i>)	Broken top; Very sparse canopy	3	3	Remove
12919	10	14	Cherry (<i>Prunus sp.</i>)		1	1	Remove
12920	11,7	15	Oregon Ash (<i>Fraxinus latifolia</i>)		1	1	Remove
12921	8	9	Douglas-fir (<i>Pseudotsuga menziesii</i>)		1	1	Remove
12922	9	8	Douglas-fir (<i>Pseudotsuga menziesii</i>)		1	1	Remove
12923	9	9	Douglas-fir (<i>Pseudotsuga menziesii</i>)		1	1	Remove
12924	8	0	Douglas-fir (<i>Pseudotsuga menziesii</i>)	Broken top; Sparse canopy	2	3	Remove
12926	11	9	Douglas-fir (<i>Pseudotsuga menziesii</i>)		1	1	Remove
12928	9	4	Douglas-fir (<i>Pseudotsuga menziesii</i>)	high canopy	1	2	Remove
12929	8	9	Douglas-fir (<i>Pseudotsuga menziesii</i>)		1	1	Remove
12930	4	3	Cherry (<i>Prunus sp.</i>)	OFFSITE; Street Tree	1	1	Preserve
12933	8,7,6,6	13	Bigleaf Maple (<i>Acer macrophyllum</i>)	Some broken limbs	1	1	Remove
12935	8	4	Douglas-fir (<i>Pseudotsuga menziesii</i>)	Broken top; Sparse canopy	2	3	Remove
12936	8	0	Douglas-fir (<i>Pseudotsuga menziesii</i>)	Dead; Broken at 30'	3	3	Remove
12937	9	7	Douglas-fir (<i>Pseudotsuga menziesii</i>)		1	1	Remove
12938	9	6	Douglas-fir (<i>Pseudotsuga menziesii</i>)		1	1	Remove
12940	8	5	Douglas-fir (<i>Pseudotsuga menziesii</i>)	Broken top; Sparse canopy	2	3	Remove
12941	10	6	Douglas-fir (<i>Pseudotsuga menziesii</i>)		1	1	Remove

Detailed Tree Inventory for Autumn Sunrise

AKS Job No. 7454 - Evaluation Date: 2/1/2021 - 4/12/2021 - Evaluated by: BRK

Tree #	DBH (in.)	Avg. Crown Radius (ft)	Tree Species Common Name (<i>Scientific name</i>)	Comments	Health Rating*	Structure Rating**	Remove/Preserve
12942	8	11	Cherry (<i>Prunus sp.</i>)	1-sided canopy (E)	1	2	Remove
12946	9	6	Douglas-fir (<i>Pseudotsuga menziesii</i>)		1	1	Remove
12947	8	6	Douglas-fir (<i>Pseudotsuga menziesii</i>)		1	1	Remove
12948	9	7	Douglas-fir (<i>Pseudotsuga menziesii</i>)		1	1	Remove
12950	10	6	Douglas-fir (<i>Pseudotsuga menziesii</i>)		1	1	Remove
12951	8,5,5	19	Oregon Ash (<i>Fraxinus latifolia</i>)		1	1	Remove
12960	4	6	Cherry (<i>Prunus sp.</i>)	OFFSITE; Street Tree	1	1	Preserve
13001	4	6	Cherry (<i>Prunus sp.</i>)	OFFSITE; Street Tree	1	1	Preserve
13002	6	6	Cherry (<i>Prunus sp.</i>)	OFFSITE; Street Tree	1	1	Preserve
13028	4	6	Cherry (<i>Prunus sp.</i>)	OFFSITE; Street Tree	1	1	Preserve
13056	4	6	Cherry (<i>Prunus sp.</i>)	OFFSITE; Street Tree	1	1	Preserve
13075	5	6	Cherry (<i>Prunus sp.</i>)	OFFSITE; Street Tree	1	1	Preserve
13123	4	6	Cherry (<i>Prunus sp.</i>)	OFFSITE; Street Tree	1	1	Preserve
13128	3	5	Cherry (<i>Prunus sp.</i>)	OFFSITE; Street Tree	1	1	Preserve
13221	2	3	Cherry (<i>Prunus sp.</i>)	OFFSITE; Street Tree; Large cavity with decay	2	2	Preserve
13222	5	5	Cherry (<i>Prunus sp.</i>)	OFFSITE; Street Tree	1	1	Preserve
13223	10	10	Scotch Pine (<i>Pinus sylvestris</i>)		1	1	Remove
13224	9	10	Scotch Pine (<i>Pinus sylvestris</i>)	Codominant with included bark	1	2	Remove
13225	9	11	Scotch Pine (<i>Pinus sylvestris</i>)	Broken top	2	3	Remove
13226	10	10	Scotch Pine (<i>Pinus sylvestris</i>)	Broken top	2	3	Remove
13227	10	10	Scotch Pine (<i>Pinus sylvestris</i>)	Broken top	2	3	Remove
13228	9	8	Scotch Pine (<i>Pinus sylvestris</i>)	Crooked bole	1	2	Remove
13229	10	11	Scotch Pine (<i>Pinus sylvestris</i>)		1	1	Remove
13230	8	7	Scotch Pine (<i>Pinus sylvestris</i>)		1	1	Remove
13231	8	8	Scotch Pine (<i>Pinus sylvestris</i>)	Broken top	2	3	Preserve
13232	14,8	13	Scotch Pine (<i>Pinus sylvestris</i>)	Broken top	2	3	Remove
13233	11	11	Scotch Pine (<i>Pinus sylvestris</i>)		1	1	Remove
13234	14	12	Scotch Pine (<i>Pinus sylvestris</i>)	LINE TREE; Codominant with included bark	1	2	Remove
13414	8,7,7	14	Cherry (<i>Prunus sp.</i>)	Large broken limbs	1	2	Remove
13421	8	9	Pine (<i>Pinus sp.</i>)	yellowing foliage	2	1	Preserve
13469	3	3	Cherry (<i>Prunus sp.</i>)	OFFSITE; Street Tree; Large cavity with decay	2	2	Preserve
15079	9	8	Douglas-fir (<i>Pseudotsuga menziesii</i>)		1	1	Remove
15080	8,7,6	11	Black Cottonwood (<i>Populus trichocarpa</i>)	Broken limbs	1	1	Remove
15301	36	20	Douglas-fir (<i>Pseudotsuga menziesii</i>)	Codominant with included bark	1	2	Remove
15303	24	19	Douglas-fir (<i>Pseudotsuga menziesii</i>)		1	1	Remove
15304	30	18	Douglas-fir (<i>Pseudotsuga menziesii</i>)		1	1	Remove
15307	8	9	Cherry (<i>Prunus sp.</i>)		1	1	Remove
15489	24	16	Douglas-fir (<i>Pseudotsuga menziesii</i>)		1	1	Remove
15490	30	15	Douglas-fir (<i>Pseudotsuga menziesii</i>)		1	1	Remove
15491	8,7	15	Willow (<i>Salix sp.</i>)		1	1	Remove
15494	11	10	Willow (<i>Salix sp.</i>)	Dead limbs; Broken limbs	2	1	Remove
15504	8,7,6	12	Cherry (<i>Prunus sp.</i>)	Broken top on one stem	2	2	Remove
15505	10	12	Black Cottonwood (<i>Populus trichocarpa</i>)		1	1	Remove
15506	8,7	11	Willow (<i>Salix sp.</i>)	1-sided canopy (S)	1	2	Remove
15508	32	20	Douglas-fir (<i>Pseudotsuga menziesii</i>)		1	1	Remove
15518	23,11,8,8	17	Bigleaf Maple (<i>Acer macrophyllum</i>)	Bulges at base	2	1	Remove
15520	8	9	Willow (<i>Salix sp.</i>)		1	1	Remove
15547	8	0	Willow (<i>Salix sp.</i>)	Dead; Broken at 15'	3	3	Remove
15549	8,8	14	Willow (<i>Salix sp.</i>)	Some broken limbs	1	1	Remove
15554	8,6,6	12	Willow (<i>Salix sp.</i>)		1	1	Remove
15556	8,7	9	Willow (<i>Salix sp.</i>)		1	1	Remove
15561	8,6	12	Willow (<i>Salix sp.</i>)	Large cavity with decay	2	2	Remove
15568	8,6,6	12	Willow (<i>Salix sp.</i>)		1	1	Remove
15574	25	16	Douglas-fir (<i>Pseudotsuga menziesii</i>)	OFFSITE; Evaluated from property line; High canopy; Dead limbs; Epicormic sprouts	2	2	Remove
15575	8	11	Bigleaf Maple (<i>Acer macrophyllum</i>)	OFFSITE; Evaluated from property line	1	1	Remove
15576	27	17	Douglas-fir (<i>Pseudotsuga menziesii</i>)	OFFSITE; Evaluated from property line; Exposed roots (W); High canopy	1	2	Remove
15578	29	16	Douglas-fir (<i>Pseudotsuga menziesii</i>)	OFFSITE; Evaluated from property line; Epicormic sprouts; High canopy	2	2	Remove
15579	24	16	Douglas-fir (<i>Pseudotsuga menziesii</i>)	LINE TREE; Evaluated from property line; Epicormic sprouts; High canopy	2	2	Remove
15581	11	10	Douglas-fir (<i>Pseudotsuga menziesii</i>)	OFFSITE; Evaluated from property line; High canopy	1	2	Preserve
15582	9	11	Bigleaf Maple (<i>Acer macrophyllum</i>)	OFFSITE; Evaluated from property line	1	1	Preserve
15585	11	7	Douglas-fir (<i>Pseudotsuga menziesii</i>)	OFFSITE; Evaluated from property line; Conks; high canopy; Sparse canopy	3	2	Remove
15586	13	16	Bigleaf Maple (<i>Acer macrophyllum</i>)	OFFSITE; Evaluated from property line	1	1	Remove
15587	11	4	Douglas-fir (<i>Pseudotsuga menziesii</i>)	OFFSITE; Evaluated from property line; Dead top; Very sparse canopy; In decline	3	2	Preserve
15588	8	15	Bigleaf Maple (<i>Acer macrophyllum</i>)	OFFSITE; Evaluated from property line; 1-sided canopy (SW)	1	2	Remove

Detailed Tree Inventory for Autumn Sunrise

AKS Job No. 7454 - Evaluation Date: 2/1/2021 - 4/12/2021 - Evaluated by: BRK

Tree #	DBH (in.)	Avg. Crown Radius (ft)	Tree Species Common Name (Scientific name)	Comments	Health Rating*	Structure Rating**	Remove/Preserve
15589	30	0	Douglas-fir (<i>Pseudotsuga menziesii</i>)	OFFSITE; Evaluated from property line; Dead (~120')	3	3	Remove
15590	24	0	Douglas-fir (<i>Pseudotsuga menziesii</i>)	OFFSITE; Evaluated from property line; Dead (~100')	3	3	Remove
15591	19	16	Douglas-fir (<i>Pseudotsuga menziesii</i>)	1-sided canopy (W); Sparse canopy	2	2	Remove
15592	18	9	Douglas-fir (<i>Pseudotsuga menziesii</i>)	LINE TREE; 1-sided canopy (W); High canopy	2	2	Remove
15594	17	7	Douglas-fir (<i>Pseudotsuga menziesii</i>)	OFFSITE; Evaluated from property line; High canopy; Sparse canopy	2	2	Remove
15595	14	6	Douglas-fir (<i>Pseudotsuga menziesii</i>)	OFFSITE; Evaluated from property line; High canopy; Sparse canopy	2	2	Remove
15596	12	17	Bigleaf Maple (<i>Acer macrophyllum</i>)	OFFSITE; Evaluated from property line	1	1	Remove
15597	13	17	Bigleaf Maple (<i>Acer macrophyllum</i>)	OFFSITE; Evaluated from property line	1	1	Remove
15598	15	7	Douglas-fir (<i>Pseudotsuga menziesii</i>)	OFFSITE; Evaluated from property line; High canopy; Dead branches; Sparse canopy	2	2	Remove
15599	30	16	Douglas-fir (<i>Pseudotsuga menziesii</i>)	LINE TREE; High canopy	1	2	Remove
15613	9,9	10	Cherry (<i>Prunus sp.</i>)	Codominant with included bark; Cavity with decay	2	2	Remove
15614	9,6	10	Willow (<i>Salix sp.</i>)		1	1	Remove
15617	23	0	Douglas-fir (<i>Pseudotsuga menziesii</i>)	OFFSITE; Evaluated from property line; Dead; Broken at 20'	3	3	Remove
15623	11	13	Willow (<i>Salix sp.</i>)		1	1	Remove
15624	9	3	Douglas-fir (<i>Pseudotsuga menziesii</i>)	OFFSITE; Evaluated from property line; Sluffing bark; High canopy; Sparse canopy; In decline	3	2	Remove
15626	9	13	Bigleaf Maple (<i>Acer macrophyllum</i>)	OFFSITE; Evaluated from property line; 1-sided canopy (W)	1	2	Remove
15627	30	14	Douglas-fir (<i>Pseudotsuga menziesii</i>)	OFFSITE; Evaluated from property line; High canopy	1	2	Remove
15629	17	8	Douglas-fir (<i>Pseudotsuga menziesii</i>)	OFFSITE; Evaluated from property line; High canopy	1	2	Preserve
15630	21	11	Douglas-fir (<i>Pseudotsuga menziesii</i>)	OFFSITE; Evaluated from property line; High canopy; 1-sided canopy (W)	1	2	Remove
15634	21	13	Douglas-fir (<i>Pseudotsuga menziesii</i>)	OFFSITE; Evaluated from property line; High canopy	1	2	Remove
15635	11	14	Bigleaf Maple (<i>Acer macrophyllum</i>)	LINE TREE	1	1	Remove
15636	14	13	Douglas-fir (<i>Pseudotsuga menziesii</i>)	OFFSITE; Evaluated from property line; High canopy	1	2	Remove
15639	30	19	Douglas-fir (<i>Pseudotsuga menziesii</i>)	OFFSITE; Evaluated from property line; High canopy; 1-sided canopy (W)	1	2	Remove
15641	30	16	Douglas-fir (<i>Pseudotsuga menziesii</i>)	OFFSITE; Evaluated from property line; High canopy	1	2	Remove
15643	6	6	Douglas-fir (<i>Pseudotsuga menziesii</i>)	OFFSITE; Evaluated from property line	1	1	Preserve
15644	27	17	Douglas-fir (<i>Pseudotsuga menziesii</i>)	OFFSITE; Evaluated from property line	1	1	Remove
15648	6	8	Douglas-fir (<i>Pseudotsuga menziesii</i>)	OFFSITE; Evaluated from property line	1	1	Preserve
15649	7	7	Douglas-fir (<i>Pseudotsuga menziesii</i>)	OFFSITE; Evaluated from property line	1	1	Preserve
15650	7	15	Douglas-fir (<i>Pseudotsuga menziesii</i>)	OFFSITE; Evaluated from property line	1	1	Preserve
15655	8	11	Cherry (<i>Prunus sp.</i>)	OFFSITE; Evaluated from property line	1	1	Preserve
15663	7,7	15	Bigleaf Maple (<i>Acer macrophyllum</i>)	OFFSITE; Evaluated from property line	1	1	Preserve
15664	9	8	Douglas-fir (<i>Pseudotsuga menziesii</i>)	OFFSITE; Evaluated from property line; 1-sided canopy (W)	1	2	Remove
15665	12	13	Douglas-fir (<i>Pseudotsuga menziesii</i>)	OFFSITE; Evaluated from property line; High canopy	1	2	Preserve
15666	13	13	Douglas-fir (<i>Pseudotsuga menziesii</i>)	OFFSITE; Evaluated from property line; High canopy	1	2	Preserve
15667	9	13	Bigleaf Maple (<i>Acer macrophyllum</i>)	OFFSITE; Evaluated from property line	1	1	Remove
15668	18	8	Douglas-fir (<i>Pseudotsuga menziesii</i>)	OFFSITE; Evaluated from property line; High canopy	1	2	Remove
15669	21	17	Douglas-fir (<i>Pseudotsuga menziesii</i>)	OFFSITE; Evaluated from property line; High canopy	1	2	Remove
15670	6	8	Douglas-fir (<i>Pseudotsuga menziesii</i>)	OFFSITE; Evaluated from property line	1	1	Preserve
15674	11	5	Douglas-fir (<i>Pseudotsuga menziesii</i>)	OFFSITE; Evaluated from property line; High canopy; A lot of sluffing bark; Sparse canopy; In decline	3	2	Preserve
15675	11	7	Douglas-fir (<i>Pseudotsuga menziesii</i>)	OFFSITE; Evaluated from property line; Dead top; Suppressed	3	2	Preserve
15676	18	10	Douglas-fir (<i>Pseudotsuga menziesii</i>)	OFFSITE; Evaluated from property line; High canopy	1	2	Preserve
15677	23	16	Douglas-fir (<i>Pseudotsuga menziesii</i>)	OFFSITE; Evaluated from property line; 1-sided canopy (S)	1	2	Preserve
15679	12,10	18	Bigleaf Maple (<i>Acer macrophyllum</i>)	OFFSITE; Evaluated from property line	1	1	Remove
15682	10	13	Douglas-fir (<i>Pseudotsuga menziesii</i>)	OFFSITE; Evaluated from property line	1	1	Remove
15683	9,7,7	13	Cherry (<i>Prunus sp.</i>)	OFFSITE; Evaluated from property line; Butt sweep	1	2	Remove
15684	7	12	Cherry (<i>Prunus sp.</i>)	OFFSITE; Evaluated from property line; High canopy	1	1	Preserve
15691	8,8,7	17	Bigleaf Maple (<i>Acer macrophyllum</i>)	OFFSITE; Evaluated from property line	1	1	Preserve
15692	6	10	Bigleaf Maple (<i>Acer macrophyllum</i>)	OFFSITE; Evaluated from property line	1	1	Preserve
15697	11,9	20	Bigleaf Maple (<i>Acer macrophyllum</i>)	LINE TREE; Evaluated from property line; 1-sided canopy (W)	1	2	Remove
15698	19	0	Douglas-fir (<i>Pseudotsuga menziesii</i>)	OFFSITE; Evaluated from property line; Dead (~100')	3	3	Remove
15702	11,8	20	Bigleaf Maple (<i>Acer macrophyllum</i>)	OFFSITE; Evaluated from property line	1	1	Remove
15703	11,7	20	Bigleaf Maple (<i>Acer macrophyllum</i>)	LINE TREE; Evaluated from property line	1	1	Remove
15704	12	15	Bigleaf Maple (<i>Acer macrophyllum</i>)	OFFSITE; Evaluated from property line; Large cavity with decay up bole	2	2	Preserve
15711	8	15	Bigleaf Maple (<i>Acer macrophyllum</i>)	Lean (N); 1-sided canopy (N)	1	2	Remove
15719	10	17	Bigleaf Maple (<i>Acer macrophyllum</i>)		1	1	Remove
15720	9,8,7,6	17	Bigleaf Maple (<i>Acer macrophyllum</i>)		1	1	Remove
15721	9,8	18	Bigleaf Maple (<i>Acer macrophyllum</i>)	1-sided canopy (S); Some broken limbs	1	2	Remove
15726	10	16	Bigleaf Maple (<i>Acer macrophyllum</i>)	1-sided canopy (W)	1	2	Remove
15727	13,13	19	Bigleaf Maple (<i>Acer macrophyllum</i>)		1	1	Remove
15732	8,6	17	Bigleaf Maple (<i>Acer macrophyllum</i>)	1-sided canopy (W)	1	2	Remove
15736	9	10	Bigleaf Maple (<i>Acer macrophyllum</i>)	OFFSITE; Evaluated from property line	1	1	Remove
15737	17	15	Bigleaf Maple (<i>Acer macrophyllum</i>)	OFFSITE; Evaluated from property line	1	1	Preserve

Detailed Tree Inventory for Autumn Sunrise

AKS Job No. 7454 - Evaluation Date: 2/1/2021 - 4/12/2021 - Evaluated by: BRK

Tree #	DBH (in.)	Avg. Crown Radius (ft)	Tree Species Common Name (Scientific name)	Comments	Health Rating*	Structure Rating**	Remove/Preserve
15738	8,6	14	Willow (<i>Salix sp.</i>)	OFFSITE; Evaluated from property line; Dead branches; Sweep	2	2	Preserve
15739	26	12	Douglas-fir (<i>Pseudotsuga menziesii</i>)	OFFSITE; Evaluated from property line; High canopy; Sparse canopy; Epicormic sprouts	2	2	Remove
15741	6	14	Bigleaf Maple (<i>Acer macrophyllum</i>)	OFFSITE; Evaluated from property line; 1-sided canopy (W); Lean (W)	1	2	Preserve
15742	15,9	19	Bigleaf Maple (<i>Acer macrophyllum</i>)	OFFSITE; Evaluated from property line	1	1	Remove
15743	23,15	14	Douglas-fir (<i>Pseudotsuga menziesii</i>)	OFFSITE; Evaluated from property line; 15" stem sluffing bark; Sparse canopy	2	2	Remove
15745	11	12	Bigleaf Maple (<i>Acer macrophyllum</i>)	OFFSITE; Evaluated from property line	1	1	Remove
15746	10,10	22	Bigleaf Maple (<i>Acer macrophyllum</i>)	OFFSITE; Evaluated from property line; 1-sided canopy (W)	1	2	Remove
15747	7	9	Bigleaf Maple (<i>Acer macrophyllum</i>)	OFFSITE; Evaluated from property line	1	1	Preserve
15748	11	0	Douglas-fir (<i>Pseudotsuga menziesii</i>)	OFFSITE; Evaluated from property line; Dead; Lean (S)	3	3	Preserve
15749	11	12	Bigleaf Maple (<i>Acer macrophyllum</i>)	OFFSITE; Evaluated from property line	1	1	Remove
15750	11	14	Bigleaf Maple (<i>Acer macrophyllum</i>)	OFFSITE; Evaluated from property line	1	1	Preserve
15751	6	20	Bigleaf Maple (<i>Acer macrophyllum</i>)	OFFSITE; Evaluated from property line; Lean (W)	1	2	Preserve
15753	13	18	Bigleaf Maple (<i>Acer macrophyllum</i>)	OFFSITE; Evaluated from property line; 1-sided canopy (SW)	1	2	Remove
15754	15,10	19	Bigleaf Maple (<i>Acer macrophyllum</i>)	50% ivy coverage; Codominant base; Stem lean (E)	2	2	Remove
15756	31	17	Douglas-fir (<i>Pseudotsuga menziesii</i>)	LINE TREE; Evaluated from property line; 50% ivy coverage; Sparse canopy	2	2	Remove
15758	15	20	Bigleaf Maple (<i>Acer macrophyllum</i>)	OFFSITE; Evaluated from property line	1	1	Remove
15759	8	7	Bigleaf Maple (<i>Acer macrophyllum</i>)	OFFSITE; Evaluated from property line	1	1	Remove
15760	8,7,6,6,6,6,6	19	Bigleaf Maple (<i>Acer macrophyllum</i>)	Epicormic stems growing from horizontal log	2	2	Remove
15761	10	14	Sweet Cherry (<i>Prunus avium</i>)	OFFSITE; Evaluated from property line	1	1	Remove
15763	24	15	Douglas-fir (<i>Pseudotsuga menziesii</i>)	OFFSITE; Evaluated from property line; High canopy	1	2	Remove
15764	25	16	Douglas-fir (<i>Pseudotsuga menziesii</i>)	OFFSITE; Evaluated from property line; 1-sided canopy (S)	1	2	Remove
15765	27	17	Douglas-fir (<i>Pseudotsuga menziesii</i>)	OFFSITE; Evaluated from property line; 50% ivy coverage	1	1	Remove
15767	11,8,6	20	Bigleaf Maple (<i>Acer macrophyllum</i>)	OFFSITE; Evaluated from property line	1	1	Remove
15768	8	14	Bigleaf Maple (<i>Acer macrophyllum</i>)	OFFSITE; Evaluated from property line	1	1	Remove
15769	15	11	Douglas-fir (<i>Pseudotsuga menziesii</i>)	OFFSITE; Evaluated from property line; 75% ivy coverage; Sparse canopy; Crooked top; High canopy	2	2	Remove
15777	23	18	Bigleaf Maple (<i>Acer macrophyllum</i>)	OFFSITE; Evaluated from property line	1	1	Remove
15781	11	18	Sweet Cherry (<i>Prunus avium</i>)	LINE TREE; Broken codominant stem; Crooked bole; Lean (S)	2	2	Remove
15784	8	14	Bigleaf Maple (<i>Acer macrophyllum</i>)	OFFSITE; Evaluated from property line	1	1	Remove
15789	6	9	Sweet Cherry (<i>Prunus avium</i>)	OFFSITE; Evaluated from property line	1	1	Preserve
15790	10	16	Bigleaf Maple (<i>Acer macrophyllum</i>)	OFFSITE; Evaluated from property line; 1-sided canopy (W)	1	2	Preserve
15791	6	8	Bigleaf Maple (<i>Acer macrophyllum</i>)	OFFSITE; Evaluated from property line; 1-sided canopy (W)	1	2	Preserve
15794	9	14	Bigleaf Maple (<i>Acer macrophyllum</i>)	OFFSITE; Evaluated from property line; Lean (W)	1	2	Preserve
15795	14,10	19	Bigleaf Maple (<i>Acer macrophyllum</i>)	OFFSITE; Evaluated from property line	1	1	Remove
15797	17	18	Bigleaf Maple (<i>Acer macrophyllum</i>)	OFFSITE; Evaluated from property line	1	1	Preserve
15798	31	15	Douglas-fir (<i>Pseudotsuga menziesii</i>)	OFFSITE; Evaluated from property line	1	1	Preserve
15799	12,6	17	Bigleaf Maple (<i>Acer macrophyllum</i>)	OFFSITE; Evaluated from property line	1	1	Preserve
15871	39	30	Douglas-fir (<i>Pseudotsuga menziesii</i>)	OFFSITE	1	1	Preserve
15879	8,7,6	18	Bigleaf Maple (<i>Acer macrophyllum</i>)	OFFSITE	1	1	Preserve
15882	13	14	Douglas-fir (<i>Pseudotsuga menziesii</i>)	OFFSITE	1	1	Preserve
15883	24	20	Douglas-fir (<i>Pseudotsuga menziesii</i>)	OFFSITE	1	1	Preserve
15887	24	17	Douglas-fir (<i>Pseudotsuga menziesii</i>)	OFFSITE; Evaluated behind fence; Recent trenching within 5' of tree	2	2	Preserve
15888	35	16	Douglas-fir (<i>Pseudotsuga menziesii</i>)	OFFSITE; Evaluated behind fence; Recent trenching within 5' of tree	2	2	Preserve
20072	10	10	Douglas-fir (<i>Pseudotsuga menziesii</i>)	OFFSITE; Evaluated from property line; 1-sided canopy (S); Lean (S)	1	2	Preserve
20073	8	3	Douglas-fir (<i>Pseudotsuga menziesii</i>)	OFFSITE; Evaluated from property line; Broken top; Sparse canopy	2	3	Preserve
20074	8	3	Douglas-fir (<i>Pseudotsuga menziesii</i>)	OFFSITE; Evaluated from property line; Broken top; Sparse canopy	2	3	Preserve
20076	13	18	Douglas-fir (<i>Pseudotsuga menziesii</i>)	OFFSITE; 1-sided canopy (N); Lean (N)	1	2	Preserve
20077	18	17	Douglas-fir (<i>Pseudotsuga menziesii</i>)	OFFSITE	1	1	Preserve
20258	14	14	Western Redcedar (<i>Thuja plicata</i>)	OFFSITE	1	1	Preserve
20261	17	14	Douglas-fir (<i>Pseudotsuga menziesii</i>)	OFFSITE; Codominant top; Exposed roots (N)	1	2	Remove
20296	12	17	Douglas-fir (<i>Pseudotsuga menziesii</i>)	OFFSITE; 1-sided canopy (S)	1	2	Preserve
20329	8,6,6	17	Bigleaf Maple (<i>Acer macrophyllum</i>)	OFFSITE	1	1	Preserve
20334	10	13	Blue Spruce (<i>Picea pungens</i>)	OFFSITE	1	1	Preserve
20336	10,13	11	Western Redcedar (<i>Thuja plicata</i>)	OFFSITE; Dead tops; Codominant base	3	2	Preserve
20338	8,11	19	Bigleaf Maple (<i>Acer macrophyllum</i>)	OFFSITE; Codominant with included bark; Exposed roots with mechanical damage	2	2	Preserve
20418	10	13	Douglas-fir (<i>Pseudotsuga menziesii</i>)	OFFSITE	1	1	Preserve
20428	12	15	Douglas-fir (<i>Pseudotsuga menziesii</i>)	OFFSITE	1	1	Preserve
20433	8	14	Douglas-fir (<i>Pseudotsuga menziesii</i>)	OFFSITE; 1-sided canopy (S)	1	2	Preserve
20710	9	10	Douglas-fir (<i>Pseudotsuga menziesii</i>)	OFFSITE	1	1	Preserve
20711	16	20	Bigleaf Maple (<i>Acer macrophyllum</i>)	OFFSITE	1	1	Preserve
20712	9	14	Douglas-fir (<i>Pseudotsuga menziesii</i>)	OFFSITE	1	1	Preserve

Detailed Tree Inventory for Autumn Sunrise

AKS Job No. 7454 - Evaluation Date: 2/1/2021 - 4/12/2021 - Evaluated by: BRK

Tree #	DBH (in.)	Avg. Crown Radius (ft)	Tree Species Common Name (<i>Scientific name</i>)	Comments	Health Rating*	Structure Rating**	Remove/Preserve
20713	13	16	Douglas-fir (<i>Pseudotsuga menziesii</i>)	OFFSITE	1	1	Preserve
20723	20	20	Atlas Cedar (<i>Cedrus atlantica</i>)	OFFSITE	1	1	Preserve
20847	16	17	Douglas-fir (<i>Pseudotsuga menziesii</i>)	OFFSITE; 1-sided canopy (S)	1	2	Remove
20848	16	17	Douglas-fir (<i>Pseudotsuga menziesii</i>)	OFFSITE; 1-sided canopy (S); Exposed roots (S)	1	2	Preserve
20952	13	11	Black Cottonwood (<i>Populus trichocarpa</i>)	OFFSITE; Exposed roots with mechanical damage all around; Broken branches	2	2	Remove
20983	14	21	Black Cottonwood (<i>Populus trichocarpa</i>)	OFFSITE; Exposed roots with mechanical damage all around; Broken branches	2	2	Remove
21075	10,10	18	Douglas-fir (<i>Pseudotsuga menziesii</i>)	OFFSITE; Codominant with included bark	1	2	Preserve
21085	8	14	Bigleaf Maple (<i>Acer macrophyllum</i>)	OFFSITE	1	1	Preserve
21126	7,16	21	Bigleaf Maple (<i>Acer macrophyllum</i>)	OFFSITE; 1-sided canopy (S)	1	2	Preserve
21128	16	20	Bigleaf Maple (<i>Acer macrophyllum</i>)	OFFSITE	1	1	Preserve
21129	11,17	20	Bigleaf Maple (<i>Acer macrophyllum</i>)	OFFSITE; 11" stem dead	2	2	Preserve
21143	13	16	Douglas-fir (<i>Pseudotsuga menziesii</i>)	OFFSITE	1	1	Preserve
21149	11	6	Douglas-fir (<i>Pseudotsuga menziesii</i>)		1	1	Remove
21150	11	9	Douglas-fir (<i>Pseudotsuga menziesii</i>)	1-sided canopy (W)	1	2	Remove
21151	10	9	Douglas-fir (<i>Pseudotsuga menziesii</i>)	1-sided canopy (W)	1	2	Remove
21152	8	7	Douglas-fir (<i>Pseudotsuga menziesii</i>)		1	1	Remove
21154	8	3	Douglas-fir (<i>Pseudotsuga menziesii</i>)	High canopy	1	2	Remove
21156	8	6	Douglas-fir (<i>Pseudotsuga menziesii</i>)		1	1	Remove
21158	8	3	Douglas-fir (<i>Pseudotsuga menziesii</i>)	High canopy	1	2	Remove
21159	9	8	Douglas-fir (<i>Pseudotsuga menziesii</i>)		1	1	Remove
21160	10	8	Douglas-fir (<i>Pseudotsuga menziesii</i>)	1-sided canopy (W)	1	2	Remove
21161	9	8	Douglas-fir (<i>Pseudotsuga menziesii</i>)		1	1	Remove
21162	9	6	Douglas-fir (<i>Pseudotsuga menziesii</i>)		1	1	Remove
21163	10	4	Douglas-fir (<i>Pseudotsuga menziesii</i>)	High canopy	1	2	Remove
21165	12	2	Douglas-fir (<i>Pseudotsuga menziesii</i>)	1-sided canopy (W)	1	2	Remove
21166	10	12	Douglas-fir (<i>Pseudotsuga menziesii</i>)	1-sided canopy (W)	1	2	Remove
21168	27	16	Douglas-fir (<i>Pseudotsuga menziesii</i>)		1	1	Remove
21169	33	21	Douglas-fir (<i>Pseudotsuga menziesii</i>)	1-sided canopy (E)	1	2	Remove
21170	22	12	Douglas-fir (<i>Pseudotsuga menziesii</i>)		1	1	Remove
21171	29	10	Douglas-fir (<i>Pseudotsuga menziesii</i>)		1	1	Remove
21172	11	6	Douglas-fir (<i>Pseudotsuga menziesii</i>)	1-sided canopy (S)	1	2	Remove
21173	28	19	Douglas-fir (<i>Pseudotsuga menziesii</i>)	1-sided canopy (S)	1	2	Remove
21174	16	9	Douglas-fir (<i>Pseudotsuga menziesii</i>)		1	1	Remove
21175	9	7	Douglas-fir (<i>Pseudotsuga menziesii</i>)	Suppressed; 1-sided canopy (S)	2	2	Remove
21176	26	20	Douglas-fir (<i>Pseudotsuga menziesii</i>)	1-sided canopy (E)	1	2	Remove
21177	21	14	Douglas-fir (<i>Pseudotsuga menziesii</i>)		1	1	Remove
21178	14	10	Douglas-fir (<i>Pseudotsuga menziesii</i>)	Sweep (N)	1	2	Remove
21179	20	19	Douglas-fir (<i>Pseudotsuga menziesii</i>)	Bore holes	2	1	Remove
21182	8	0	Douglas-fir (<i>Pseudotsuga menziesii</i>)	Dead; Broken at 40'	3	3	Remove
21183	9	6	Douglas-fir (<i>Pseudotsuga menziesii</i>)		1	1	Remove
21184	11	8	Douglas-fir (<i>Pseudotsuga menziesii</i>)		1	1	Remove
21185	38	25	Douglas-fir (<i>Pseudotsuga menziesii</i>)		1	1	Remove
21186	8	0	Douglas-fir (<i>Pseudotsuga menziesii</i>)	Dead	3	3	Remove
21188	23	17	Douglas-fir (<i>Pseudotsuga menziesii</i>)	1-sided canopy (N); Crooked bole	1	2	Remove
21189	34	16	Douglas-fir (<i>Pseudotsuga menziesii</i>)	Weak attachment; Bulges; Lean (N)	2	2	Remove
21190	12	7	Douglas-fir (<i>Pseudotsuga menziesii</i>)		1	1	Remove
21191	21	17	Douglas-fir (<i>Pseudotsuga menziesii</i>)	1-sided canopy (N)	1	2	Remove
21192	27	17	Douglas-fir (<i>Pseudotsuga menziesii</i>)	1-sided canopy (W)	1	2	Remove
21193	22	18	Douglas-fir (<i>Pseudotsuga menziesii</i>)	1-sided canopy (W)	1	2	Remove
21194	24	19	Douglas-fir (<i>Pseudotsuga menziesii</i>)	1-sided canopy (W)	1	2	Remove
21195	30	18	Douglas-fir (<i>Pseudotsuga menziesii</i>)		1	1	Remove
21196	20	15	Douglas-fir (<i>Pseudotsuga menziesii</i>)	Sweep; 1-sided canopy (S)	1	2	Remove
21197	25	16	Douglas-fir (<i>Pseudotsuga menziesii</i>)		1	1	Remove
21198	28	20	Douglas-fir (<i>Pseudotsuga menziesii</i>)	1-sided canopy (S); Dead branches	2	2	Remove
21199	10	6	Douglas-fir (<i>Pseudotsuga menziesii</i>)		1	1	Remove
21200	9	0	Douglas-fir (<i>Pseudotsuga menziesii</i>)	Dead; Broken at 40'	3	3	Remove
21204	9	6	Douglas-fir (<i>Pseudotsuga menziesii</i>)	1-sided canopy (E)	1	2	Remove
21205	11	7	Douglas-fir (<i>Pseudotsuga menziesii</i>)		1	1	Remove
21207	10	6	Douglas-fir (<i>Pseudotsuga menziesii</i>)	1-sided canopy (S)	1	2	Remove
21209	8	6	Douglas-fir (<i>Pseudotsuga menziesii</i>)	Broken top	2	3	Remove
21211	9	5	Douglas-fir (<i>Pseudotsuga menziesii</i>)	High canopy	1	2	Remove
21212	9	5	Douglas-fir (<i>Pseudotsuga menziesii</i>)	High canopy	1	2	Remove
21213	11	7	Douglas-fir (<i>Pseudotsuga menziesii</i>)		1	1	Remove
21214	9	5	Douglas-fir (<i>Pseudotsuga menziesii</i>)	High canopy	1	2	Remove
21215	9	4	Douglas-fir (<i>Pseudotsuga menziesii</i>)	High canopy	1	2	Remove
21216	10	7	Douglas-fir (<i>Pseudotsuga menziesii</i>)		1	1	Remove
21217	8	5	Douglas-fir (<i>Pseudotsuga menziesii</i>)		1	1	Remove
21221	34	21	Douglas-fir (<i>Pseudotsuga menziesii</i>)		1	1	Remove

Detailed Tree Inventory for Autumn Sunrise

AKS Job No. 7454 - Evaluation Date: 2/1/2021 - 4/12/2021 - Evaluated by: BRK

Tree #	DBH (in.)	Avg. Crown Radius (ft)	Tree Species Common Name (<i>Scientific name</i>)	Comments	Health Rating*	Structure Rating**	Remove/Preserve
21222	27	19	Douglas-fir (<i>Pseudotsuga menziesii</i>)	Many broken branches; Sparse canopy; Crooked bole	2	2	Remove
21224	20	10	Douglas-fir (<i>Pseudotsuga menziesii</i>)		1	1	Remove
21225	9	6	Douglas-fir (<i>Pseudotsuga menziesii</i>)	Broken top	2	3	Remove
21226	13	8	Douglas-fir (<i>Pseudotsuga menziesii</i>)		1	1	Remove
21227	10	7	Douglas-fir (<i>Pseudotsuga menziesii</i>)	Broken top	2	3	Remove
21228	11	6	Douglas-fir (<i>Pseudotsuga menziesii</i>)		1	1	Remove
21230	10	8	Douglas-fir (<i>Pseudotsuga menziesii</i>)		1	1	Remove
21233	10	8	Douglas-fir (<i>Pseudotsuga menziesii</i>)		1	1	Remove
21234	13	9	Douglas-fir (<i>Pseudotsuga menziesii</i>)		1	1	Remove
21235	9	4	Douglas-fir (<i>Pseudotsuga menziesii</i>)	High canopy; Epicormic sprouts	2	2	Remove
21236	9	6	Douglas-fir (<i>Pseudotsuga menziesii</i>)		1	1	Remove
21237	8	5	Douglas-fir (<i>Pseudotsuga menziesii</i>)	Lean (N); Mechanical damage	2	2	Remove
21239	9	7	Douglas-fir (<i>Pseudotsuga menziesii</i>)	1-sided canopy (W)	1	2	Remove
50001	9	8	Douglas-fir (<i>Pseudotsuga menziesii</i>)		1	1	Remove
50002	13	17	Sweet Cherry (<i>Prunus avium</i>)	Some broken limbs	1	1	Remove
50003	8	4	Douglas-fir (<i>Pseudotsuga menziesii</i>)	High canopy; Sparse canopy	2	2	Remove
50008	8	5	Douglas-fir (<i>Pseudotsuga menziesii</i>)	Broken top; Sparse canopy	2	3	Remove
50009	8	9	Douglas-fir (<i>Pseudotsuga menziesii</i>)		1	1	Remove
50010	10	9	Douglas-fir (<i>Pseudotsuga menziesii</i>)	1-sided canopy (S)	1	2	Remove
50011	10	7	Douglas-fir (<i>Pseudotsuga menziesii</i>)		1	1	Remove
50013	10	7	Douglas-fir (<i>Pseudotsuga menziesii</i>)		1	1	Remove
50014	8	7	Douglas-fir (<i>Pseudotsuga menziesii</i>)		1	1	Remove
50015	9	8	Douglas-fir (<i>Pseudotsuga menziesii</i>)		1	1	Remove
50016	8,6	14	Bigleaf Maple (<i>Acer macrophyllum</i>)	Some dead limbs; Broken branches; Lean (E)	2	2	Remove
50017	11	6	Douglas-fir (<i>Pseudotsuga menziesii</i>)		1	1	Remove
50018	9	8	Douglas-fir (<i>Pseudotsuga menziesii</i>)	High canopy	1	2	Remove
50019	8	10	Douglas-fir (<i>Pseudotsuga menziesii</i>)		1	1	Remove
50021	12	8	Douglas-fir (<i>Pseudotsuga menziesii</i>)		1	1	Remove
50026	22	16	Douglas-fir (<i>Pseudotsuga menziesii</i>)	OFFSITE; Evaluated from property line; Epicormic sprouts; Over extended limbs	2	2	Remove
50030	9,20	10	Douglas-fir (<i>Pseudotsuga menziesii</i>)	OFFSITE; Evaluated from property line; High canopy	1	2	Remove
50041	8	9	Douglas-fir (<i>Pseudotsuga menziesii</i>)		1	1	Remove
50046	12	0	Douglas-fir (<i>Pseudotsuga menziesii</i>)	LINE TREE; Evaluated from property line; Dead; broken at 10'	3	3	Remove
50047	12	11	Douglas-fir (<i>Pseudotsuga menziesii</i>)		1	1	Remove
50051	8	4	Douglas-fir (<i>Pseudotsuga menziesii</i>)	High canopy	1	2	Remove
50052	9,9,9,9,6	20	Bigleaf Maple (<i>Acer macrophyllum</i>)	Some broken branches	1	1	Remove
50055	11	8	Douglas-fir (<i>Pseudotsuga menziesii</i>)		1	1	Remove
50061	24	14	Douglas-fir (<i>Pseudotsuga menziesii</i>)	High canopy	1	2	Remove
50062	11	12	Bigleaf Maple (<i>Acer macrophyllum</i>)	OFFSITE; Evaluated from property line	1	1	Remove
50064	23	10	Douglas-fir (<i>Pseudotsuga menziesii</i>)	OFFSITE; Evaluated from property line; Epicormic sprouts; Few dead limbs	2	1	Remove
50065	12	0	Douglas-fir (<i>Pseudotsuga menziesii</i>)	OFFSITE; Evaluated from property line; Dead; Broken at 25'	3	3	Remove
50071	11	8	Douglas-fir (<i>Pseudotsuga menziesii</i>)		1	1	Remove
50075	8	0	Douglas-fir (<i>Pseudotsuga menziesii</i>)	Dead; broken at 30'	3	3	Remove
50077	10	9	Douglas-fir (<i>Pseudotsuga menziesii</i>)		1	1	Remove
50078	10	9	Douglas-fir (<i>Pseudotsuga menziesii</i>)		1	1	Remove
50079	10	9	Douglas-fir (<i>Pseudotsuga menziesii</i>)		1	1	Remove
50081	9	7	Douglas-fir (<i>Pseudotsuga menziesii</i>)		1	1	Remove
50086	9	6	Douglas-fir (<i>Pseudotsuga menziesii</i>)		1	1	Remove
50087	8,6	20	Bigleaf Maple (<i>Acer macrophyllum</i>)	Lean; Dead limbs	2	2	Remove
50088	9	6	Douglas-fir (<i>Pseudotsuga menziesii</i>)	High canopy; 1-sided canopy (S)	1	2	Remove
50090	9	7	Douglas-fir (<i>Pseudotsuga menziesii</i>)		1	1	Remove
50091	8	5	Douglas-fir (<i>Pseudotsuga menziesii</i>)	High canopy; 1-sided canopy (S)	1	2	Remove
50092	8,8,6,6	15	Bigleaf Maple (<i>Acer macrophyllum</i>)	1-sided canopy (W)	1	2	Remove
50094	8	10	Douglas-fir (<i>Pseudotsuga menziesii</i>)	High canopy	1	2	Remove
50095	9	7	Douglas-fir (<i>Pseudotsuga menziesii</i>)		1	1	Remove
50097	8	5	Douglas-fir (<i>Pseudotsuga menziesii</i>)		1	1	Remove
50098	8	8	Douglas-fir (<i>Pseudotsuga menziesii</i>)		1	1	Remove
50103	8	0	Douglas-fir (<i>Pseudotsuga menziesii</i>)	Dead; Broken at 45'	3	3	Remove
50104	9,7,6,6,6	11	Bigleaf Maple (<i>Acer macrophyllum</i>)	Some broken limbs	1	1	Remove
50105	9	13	Sweet Cherry (<i>Prunus avium</i>)	Sweep	1	2	Remove
50107	8	6	Douglas-fir (<i>Pseudotsuga menziesii</i>)		1	1	Remove
50109	9	10	Douglas-fir (<i>Pseudotsuga menziesii</i>)	High canopy	1	2	Remove
50112	10	10	Douglas-fir (<i>Pseudotsuga menziesii</i>)		1	1	Remove
50113	9	8	Douglas-fir (<i>Pseudotsuga menziesii</i>)		1	1	Remove
50117	8,8,7	14	Bigleaf Maple (<i>Acer macrophyllum</i>)		1	1	Remove
50121	23	16	Douglas-fir (<i>Pseudotsuga menziesii</i>)	OFFSITE; Evaluated from property line; high canopy	1	2	Remove
50123	10	15	Bigleaf Maple (<i>Acer macrophyllum</i>)	OFFSITE; Evaluated from property line	1	1	Remove
50124	13	8	Douglas-fir (<i>Pseudotsuga menziesii</i>)	OFFSITE; Evaluated from property line	1	1	Preserve
50127	10,11	10	Oregon Ash (<i>Fraxinus latifolia</i>)		1	1	Remove

Detailed Tree Inventory for Autumn Sunrise

AKS Job No. 7454 - Evaluation Date: 2/1/2021 - 4/12/2021 - Evaluated by: BRK

Tree #	DBH (in.)	Avg. Crown Radius (ft)	Tree Species Common Name (<i>Scientific name</i>)	Comments	Health Rating*	Structure Rating**	Remove/Preserve
50129	8,7,6	14	Bigleaf Maple (<i>Acer macrophyllum</i>)		1	1	Remove
50131	9	7	Douglas-fir (<i>Pseudotsuga menziesii</i>)	High canopy	1	2	Remove
50133	9,10,11	15	Bigleaf Maple (<i>Acer macrophyllum</i>)	Some broken limbs	1	1	Remove
50135	9	10	Douglas-fir (<i>Pseudotsuga menziesii</i>)		1	1	Remove
50137	8	12	Douglas-fir (<i>Pseudotsuga menziesii</i>)	Top lean (E)	1	2	Remove
50138	8	14	Bigleaf Maple (<i>Acer macrophyllum</i>)	Suppressed; Dead branches	2	2	Remove
50139	10	10	Douglas-fir (<i>Pseudotsuga menziesii</i>)		1	1	Remove
50140	10	10	Douglas-fir (<i>Pseudotsuga menziesii</i>)		1	1	Remove
50142	8	4	Douglas-fir (<i>Pseudotsuga menziesii</i>)	High canopy; Sparse canopy	2	2	Remove
50143	10	3	Douglas-fir (<i>Pseudotsuga menziesii</i>)	High canopy; Sparse canopy	2	2	Remove
50146	12	15	Douglas-fir (<i>Pseudotsuga menziesii</i>)		1	1	Remove
50148	9	7	Douglas-fir (<i>Pseudotsuga menziesii</i>)		1	1	Remove
50149	12	9	Douglas-fir (<i>Pseudotsuga menziesii</i>)		1	1	Remove
50151	10	7	Douglas-fir (<i>Pseudotsuga menziesii</i>)		1	1	Remove
50152	10	14	Douglas-fir (<i>Pseudotsuga menziesii</i>)	1-sided canopy (S)	1	2	Remove
50153	8	8	Douglas-fir (<i>Pseudotsuga menziesii</i>)		1	1	Remove
50154	8	7	Douglas-fir (<i>Pseudotsuga menziesii</i>)		1	1	Remove
50155	10	10	Douglas-fir (<i>Pseudotsuga menziesii</i>)		1	1	Remove
50157	8	9	Douglas-fir (<i>Pseudotsuga menziesii</i>)		1	1	Remove
50160	9	4	Douglas-fir (<i>Pseudotsuga menziesii</i>)	Broken top; Sparse canopy	2	3	Remove
50161	10	7	Douglas-fir (<i>Pseudotsuga menziesii</i>)		1	1	Remove
50164	9	8	Douglas-fir (<i>Pseudotsuga menziesii</i>)	1-sided canopy (E)	1	2	Remove
50165	9	6	Douglas-fir (<i>Pseudotsuga menziesii</i>)	Broken top; Sparse canopy	2	3	Remove
50166	10	8	Douglas-fir (<i>Pseudotsuga menziesii</i>)		1	1	Remove
50168	9	7	Douglas-fir (<i>Pseudotsuga menziesii</i>)		1	1	Remove
50169	8	5	Douglas-fir (<i>Pseudotsuga menziesii</i>)	Broken top; Sparse canopy	2	3	Remove
50172	10	7	Douglas-fir (<i>Pseudotsuga menziesii</i>)		1	1	Remove
50175	10	10	Douglas-fir (<i>Pseudotsuga menziesii</i>)		1	1	Remove
50176	10	8	Douglas-fir (<i>Pseudotsuga menziesii</i>)		1	1	Remove
50179	8	8	Douglas-fir (<i>Pseudotsuga menziesii</i>)		1	1	Remove
50184	10	9	Douglas-fir (<i>Pseudotsuga menziesii</i>)		1	1	Remove
50190	13	15	Bigleaf Maple (<i>Acer macrophyllum</i>)	OFFSITE; Evaluated from property line	1	1	Remove
50193	10	6	Douglas-fir (<i>Pseudotsuga menziesii</i>)		1	1	Remove
50194	9	8	Douglas-fir (<i>Pseudotsuga menziesii</i>)		1	1	Remove
50195	9	4	Douglas-fir (<i>Pseudotsuga menziesii</i>)	Broken top; Sparse canopy	2	3	Remove
50196	12	10	Douglas-fir (<i>Pseudotsuga menziesii</i>)		1	1	Remove
50197	8	8	Douglas-fir (<i>Pseudotsuga menziesii</i>)	Broken top; Sparse canopy	2	3	Remove
50199	9,8,8,7,6	20	Bigleaf Maple (<i>Acer macrophyllum</i>)	Some broken limbs	1	1	Remove
50200	9,7	17	Bigleaf Maple (<i>Acer macrophyllum</i>)		1	1	Remove
50204	11	15	Douglas-fir (<i>Pseudotsuga menziesii</i>)	1-sided canopy (S)	1	2	Remove
50207	8	7	Douglas-fir (<i>Pseudotsuga menziesii</i>)		1	1	Remove
50208	12	9	Douglas-fir (<i>Pseudotsuga menziesii</i>)		1	1	Remove
50213	17,10	18	Bigleaf Maple (<i>Acer macrophyllum</i>)	Cavity with decay in base; 1-sided canopy (E)	2	2	Remove
50216	17	17	Bigleaf Maple (<i>Acer macrophyllum</i>)		1	1	Remove
50218	8,8	0	Bigleaf Maple (<i>Acer macrophyllum</i>)	Dead; Broken at 30'	3	3	Remove
50219	8	0	Bigleaf Maple (<i>Acer macrophyllum</i>)	Dead; Broken at 30'	3	3	Remove
50223	9,11	15	Douglas-fir (<i>Pseudotsuga menziesii</i>)	Codominant base with included bark	1	2	Remove
50224	9	11	Douglas-fir (<i>Pseudotsuga menziesii</i>)	1-sided canopy (S)	1	2	Remove
50226	12	11	Douglas-fir (<i>Pseudotsuga menziesii</i>)		1	1	Remove
50229	9	6	Douglas-fir (<i>Pseudotsuga menziesii</i>)		1	1	Remove
50233	9	12	Douglas-fir (<i>Pseudotsuga menziesii</i>)	1-sided canopy (E)	1	2	Remove
50234	14	11	Douglas-fir (<i>Pseudotsuga menziesii</i>)		1	1	Remove
50236	11	11	Douglas-fir (<i>Pseudotsuga menziesii</i>)	1-sided canopy (E)	1	2	Remove
50239	10	11	Douglas-fir (<i>Pseudotsuga menziesii</i>)		1	1	Remove
50242	13	11	Douglas-fir (<i>Pseudotsuga menziesii</i>)	1-sided canopy (S)	1	2	Remove
50244	13	13	Douglas-fir (<i>Pseudotsuga menziesii</i>)		1	1	Remove
50245	9	7	Douglas-fir (<i>Pseudotsuga menziesii</i>)		1	1	Remove
50246	9	8	Douglas-fir (<i>Pseudotsuga menziesii</i>)		1	1	Remove
50248	12	8	Douglas-fir (<i>Pseudotsuga menziesii</i>)	Broken branches; 1-sided canopy (E)	1	2	Remove
50250	11	8	Douglas-fir (<i>Pseudotsuga menziesii</i>)		1	1	Remove
50251	11	10	Douglas-fir (<i>Pseudotsuga menziesii</i>)		1	1	Remove
50252	10	8	Douglas-fir (<i>Pseudotsuga menziesii</i>)		1	1	Remove
50253	10	5	Douglas-fir (<i>Pseudotsuga menziesii</i>)	High canopy	1	2	Remove
50257	11	7	Douglas-fir (<i>Pseudotsuga menziesii</i>)		1	1	Remove
50258	9	8	Douglas-fir (<i>Pseudotsuga menziesii</i>)		1	1	Remove
50259	10	9	Douglas-fir (<i>Pseudotsuga menziesii</i>)		1	1	Remove
50260	11	8	Douglas-fir (<i>Pseudotsuga menziesii</i>)		1	1	Remove
50261	11	10	Douglas-fir (<i>Pseudotsuga menziesii</i>)		1	1	Remove
50264	11	12	Douglas-fir (<i>Pseudotsuga menziesii</i>)		1	1	Remove

Detailed Tree Inventory for Autumn Sunrise

AKS Job No. 7454 - Evaluation Date: 2/1/2021 - 4/12/2021 - Evaluated by: BRK

Tree #	DBH (in.)	Avg. Crown Radius (ft)	Tree Species Common Name (Scientific name)	Comments	Health Rating*	Structure Rating**	Remove/Preserve
50265	8	7	Douglas-fir (<i>Pseudotsuga menziesii</i>)		1	1	Remove
50267	12	11	Douglas-fir (<i>Pseudotsuga menziesii</i>)		1	1	Remove
50269	8,7	10	Douglas-fir (<i>Pseudotsuga menziesii</i>)	Codominant base; 1 stem broken top	2	2	Remove
50270	11	6	Douglas-fir (<i>Pseudotsuga menziesii</i>)	High canopy	1	2	Remove
50272	10	14	Douglas-fir (<i>Pseudotsuga menziesii</i>)		1	1	Remove
50273	9	0	Douglas-fir (<i>Pseudotsuga menziesii</i>)	Dead; Broken at 40'	3	3	Remove
50274	9	6	Douglas-fir (<i>Pseudotsuga menziesii</i>)		1	1	Remove
50282	10	4	Douglas-fir (<i>Pseudotsuga menziesii</i>)	Sparse canopy	2	2	Remove
50284	8	0	Douglas-fir (<i>Pseudotsuga menziesii</i>)	Dead	3	3	Remove
50285	8	8	Douglas-fir (<i>Pseudotsuga menziesii</i>)		1	1	Remove
50287	12	7	Douglas-fir (<i>Pseudotsuga menziesii</i>)		1	1	Remove
50289	9	0	Douglas-fir (<i>Pseudotsuga menziesii</i>)	Dead	3	3	Remove
50291	8	5	Douglas-fir (<i>Pseudotsuga menziesii</i>)	Sparse canopy; High canopy; 1-sided canopy (N)	2	2	Remove
50293	8	0	Douglas-fir (<i>Pseudotsuga menziesii</i>)	Dead; Broken at 40'	3	3	Remove
50294	10	9	Douglas-fir (<i>Pseudotsuga menziesii</i>)	Broken top; Sparse canopy	2	3	Remove
50295	8	14	Douglas-fir (<i>Pseudotsuga menziesii</i>)	Top lean (W)	1	2	Remove
50297	9	10	Sweet Cherry (<i>Prunus avium</i>)		1	1	Remove
50298	11	8	Douglas-fir (<i>Pseudotsuga menziesii</i>)		1	1	Remove
50300	9	7	Douglas-fir (<i>Pseudotsuga menziesii</i>)		1	1	Remove
50301	9,9,8,7,6	16	Bigleaf Maple (<i>Acer macrophyllum</i>)		1	1	Remove
50303	10	8	Douglas-fir (<i>Pseudotsuga menziesii</i>)		1	1	Remove
50304	11	9	Douglas-fir (<i>Pseudotsuga menziesii</i>)		1	1	Remove
50306	12	9	Douglas-fir (<i>Pseudotsuga menziesii</i>)		1	1	Remove
50307	10	18	Sweet Cherry (<i>Prunus avium</i>)	Exposed roots all around	1	1	Remove
50308	11	18	Sweet Cherry (<i>Prunus avium</i>)	Exposed roots all around	1	1	Remove
50310	10	16	Bigleaf Maple (<i>Acer macrophyllum</i>)	1-sided canopy (S)	1	2	Remove
50314	10	7	Douglas-fir (<i>Pseudotsuga menziesii</i>)		1	1	Remove
50315	8	6	Douglas-fir (<i>Pseudotsuga menziesii</i>)		1	1	Remove
50316	9	10	Douglas-fir (<i>Pseudotsuga menziesii</i>)	1-sided canopy (NE)	1	2	Remove
50319	8	6	Douglas-fir (<i>Pseudotsuga menziesii</i>)	1-sided canopy (E)	1	2	Remove
50320	13	10	Douglas-fir (<i>Pseudotsuga menziesii</i>)		1	1	Remove
50321	9	8	Douglas-fir (<i>Pseudotsuga menziesii</i>)		1	1	Remove
50322	9	6	Douglas-fir (<i>Pseudotsuga menziesii</i>)	Broken top; Sparse canopy	2	3	Remove
50323	10	9	Douglas-fir (<i>Pseudotsuga menziesii</i>)	High canopy	1	2	Remove
50329	9	0	Douglas-fir (<i>Pseudotsuga menziesii</i>)	Dead	3	3	Remove
50331	9	10	Douglas-fir (<i>Pseudotsuga menziesii</i>)	Broken top; Sparse canopy	2	3	Remove
50334	8	0	Douglas-fir (<i>Pseudotsuga menziesii</i>)	Dead; Broken at 40'	3	3	Remove
50335	11	8	Douglas-fir (<i>Pseudotsuga menziesii</i>)		1	1	Remove
50336	8	6	Douglas-fir (<i>Pseudotsuga menziesii</i>)		1	1	Remove
50338	9	9	Douglas-fir (<i>Pseudotsuga menziesii</i>)		1	1	Remove
50339	8	6	Douglas-fir (<i>Pseudotsuga menziesii</i>)		1	1	Remove
50341	8	5	Douglas-fir (<i>Pseudotsuga menziesii</i>)	High canopy	1	2	Remove
50342	10	10	Douglas-fir (<i>Pseudotsuga menziesii</i>)		1	1	Remove
50348	8	8	Douglas-fir (<i>Pseudotsuga menziesii</i>)		1	1	Remove
50349	14,7,7,6	16	Bigleaf Maple (<i>Acer macrophyllum</i>)		1	1	Remove
50358	20	10	Douglas-fir (<i>Pseudotsuga menziesii</i>)	OFFSITE; Evaluated from property line; high canopy	1	2	Preserve
50359	26	21	Bigleaf Maple (<i>Acer macrophyllum</i>)	OFFSITE; Evaluated from property line; Some broken limbs; Crooked bole	1	2	Preserve
50362	27	16	Douglas-fir (<i>Pseudotsuga menziesii</i>)	OFFSITE; Evaluated from property line; high canopy	1	2	Remove
50363	9	19	Bigleaf Maple (<i>Acer macrophyllum</i>)	OFFSITE; Evaluated from property line; Lean (W)	1	2	Remove
50364	9	12	Bigleaf Maple (<i>Acer macrophyllum</i>)	OFFSITE; Evaluated from property line	1	1	Remove
50366	28	16	Douglas-fir (<i>Pseudotsuga menziesii</i>)	OFFSITE; Evaluated from property line; 25% ivy coverage; Epicormic sprouts	2	1	Remove
50370	12	15	Bigleaf Maple (<i>Acer macrophyllum</i>)	OFFSITE; Evaluated from property line	1	1	Remove
50372	9	8	Douglas-fir (<i>Pseudotsuga menziesii</i>)		1	1	Remove
50380	9	11	Douglas-fir (<i>Pseudotsuga menziesii</i>)	1-sided canopy (S)	1	2	Remove
50382	8	0	Willow (<i>Salix sp.</i>)	Dead	3	3	Remove
50383	13	7	Douglas-fir (<i>Pseudotsuga menziesii</i>)		1	1	Remove
50386	11	19	Douglas-fir (<i>Pseudotsuga menziesii</i>)	1-sided canopy (N)	1	2	Remove
50387	12	15	Douglas-fir (<i>Pseudotsuga menziesii</i>)		1	1	Remove
50388	12	18	Douglas-fir (<i>Pseudotsuga menziesii</i>)	1-sided canopy (S)	1	2	Remove
50389	13	17	Douglas-fir (<i>Pseudotsuga menziesii</i>)	Exposed roots (N)	1	2	Remove
50391	10	12	Douglas-fir (<i>Pseudotsuga menziesii</i>)		1	1	Remove
50393	12	13	Douglas-fir (<i>Pseudotsuga menziesii</i>)	1-sided canopy (S)	1	2	Remove
50394	13	15	Douglas-fir (<i>Pseudotsuga menziesii</i>)	1-sided canopy (S)	1	2	Remove
50397	8	7	Douglas-fir (<i>Pseudotsuga menziesii</i>)		1	1	Remove
50398	11	11	Douglas-fir (<i>Pseudotsuga menziesii</i>)		1	1	Remove
50401	13	15	Douglas-fir (<i>Pseudotsuga menziesii</i>)		1	1	Remove
50402	9	6	Douglas-fir (<i>Pseudotsuga menziesii</i>)	High canopy	1	2	Remove
50404	10	12	Douglas-fir (<i>Pseudotsuga menziesii</i>)		1	1	Remove

Detailed Tree Inventory for Autumn Sunrise

AKS Job No. 7454 - Evaluation Date: 2/1/2021 - 4/12/2021 - Evaluated by: BRK

Tree #	DBH (in.)	Avg. Crown Radius (ft)	Tree Species Common Name (<i>Scientific name</i>)	Comments	Health Rating*	Structure Rating**	Remove/Preserve
50406	8	0	Douglas-fir (<i>Pseudotsuga menziesii</i>)	Dead	3	3	Remove
50408	25	18	Douglas-fir (<i>Pseudotsuga menziesii</i>)	1-sided canopy (S)	1	2	Remove
50409	9	8	Douglas-fir (<i>Pseudotsuga menziesii</i>)	Broken top; Sparse canopy	2	3	Remove
50411	10	7	Douglas-fir (<i>Pseudotsuga menziesii</i>)		1	1	Remove
50412	7	5	Douglas-fir (<i>Pseudotsuga menziesii</i>)	High canopy	1	2	Remove
50413	10	5	Douglas-fir (<i>Pseudotsuga menziesii</i>)		1	1	Remove
50415	8	4	Douglas-fir (<i>Pseudotsuga menziesii</i>)	High canopy	1	2	Remove
50416	14	10	Douglas-fir (<i>Pseudotsuga menziesii</i>)		1	1	Remove
50418	8	4	Douglas-fir (<i>Pseudotsuga menziesii</i>)	High canopy	1	2	Remove
50419	8	5	Douglas-fir (<i>Pseudotsuga menziesii</i>)	High canopy	1	2	Remove
50420	10	6	Douglas-fir (<i>Pseudotsuga menziesii</i>)		1	1	Remove
50422	12	10	Douglas-fir (<i>Pseudotsuga menziesii</i>)		1	1	Remove
50423	9	6	Douglas-fir (<i>Pseudotsuga menziesii</i>)	High canopy	1	2	Remove
50424	13	10	Douglas-fir (<i>Pseudotsuga menziesii</i>)		1	1	Remove
50425	12	12	Douglas-fir (<i>Pseudotsuga menziesii</i>)		1	1	Remove
50427	14	16	Douglas-fir (<i>Pseudotsuga menziesii</i>)	1-sided canopy (S)	1	2	Remove
50428	12	8	Douglas-fir (<i>Pseudotsuga menziesii</i>)	Broken top; Crooked bole	2	3	Remove
50433	10	11	Douglas-fir (<i>Pseudotsuga menziesii</i>)	1-sided canopy (S)	1	2	Remove
50434	13	7	Douglas-fir (<i>Pseudotsuga menziesii</i>)		1	1	Remove
50435	11	10	Douglas-fir (<i>Pseudotsuga menziesii</i>)		1	1	Remove
50443	13	14	Douglas-fir (<i>Pseudotsuga menziesii</i>)	1-sided canopy (S)	1	2	Remove
50444	9	8	Douglas-fir (<i>Pseudotsuga menziesii</i>)		1	1	Remove
50445	12	6	Douglas-fir (<i>Pseudotsuga menziesii</i>)		1	1	Remove
50446	12	9	Douglas-fir (<i>Pseudotsuga menziesii</i>)		1	1	Remove
50447	13	12	Douglas-fir (<i>Pseudotsuga menziesii</i>)		1	1	Remove
50449	9	3	Douglas-fir (<i>Pseudotsuga menziesii</i>)	High canopy	1	2	Remove
50450	10	10	Douglas-fir (<i>Pseudotsuga menziesii</i>)		1	1	Remove
50452	12	11	Douglas-fir (<i>Pseudotsuga menziesii</i>)		1	1	Remove
50453	10	6	Douglas-fir (<i>Pseudotsuga menziesii</i>)		1	1	Remove
50454	12	13	Douglas-fir (<i>Pseudotsuga menziesii</i>)		1	1	Remove
50457	11	12	Douglas-fir (<i>Pseudotsuga menziesii</i>)		1	1	Remove
50458	10	9	Douglas-fir (<i>Pseudotsuga menziesii</i>)		1	1	Remove
50460	12	13	Douglas-fir (<i>Pseudotsuga menziesii</i>)	1-sided canopy (W); Crooked top	1	2	Remove
50463	11	14	Douglas-fir (<i>Pseudotsuga menziesii</i>)		1	1	Remove
50466	7,6	0	Willow (<i>Salix sp.</i>)	Failed codominant stem; Other stem dead	3	3	Remove
50467	13	12	Douglas-fir (<i>Pseudotsuga menziesii</i>)		1	1	Remove
50469	9	0	Douglas-fir (<i>Pseudotsuga menziesii</i>)	Dead; Broken at 40'	3	3	Remove
50470	10	11	Douglas-fir (<i>Pseudotsuga menziesii</i>)		1	1	Remove
50471	13	13	Douglas-fir (<i>Pseudotsuga menziesii</i>)		1	1	Remove
50472	9	6	Douglas-fir (<i>Pseudotsuga menziesii</i>)	High canopy	1	2	Remove
50474	12	11	Douglas-fir (<i>Pseudotsuga menziesii</i>)		1	1	Remove
50476	8	0	Douglas-fir (<i>Pseudotsuga menziesii</i>)	Dead	3	3	Remove
50477	9	9	Douglas-fir (<i>Pseudotsuga menziesii</i>)	Broken top; Sparse canopy	2	3	Remove
50483	9	7	Douglas-fir (<i>Pseudotsuga menziesii</i>)	1-sided canopy (S)	1	2	Remove
50487	9	9	Douglas-fir (<i>Pseudotsuga menziesii</i>)		1	1	Remove
50489	9	7	Douglas-fir (<i>Pseudotsuga menziesii</i>)		1	1	Remove
50490	11	11	Douglas-fir (<i>Pseudotsuga menziesii</i>)		1	1	Remove
50491	10	6	Douglas-fir (<i>Pseudotsuga menziesii</i>)	Broken top; Sparse canopy	2	3	Remove
50492	11	9	Douglas-fir (<i>Pseudotsuga menziesii</i>)		1	1	Remove
50495	10	6	Douglas-fir (<i>Pseudotsuga menziesii</i>)	Codominant stem; High canopy	1	2	Remove
50498	8,7	0	Douglas-fir (<i>Pseudotsuga menziesii</i>)	Dead; Broken at 50'	3	3	Remove
50499	9	6	Douglas-fir (<i>Pseudotsuga menziesii</i>)	High canopy	1	2	Remove
50500	9	8	Douglas-fir (<i>Pseudotsuga menziesii</i>)	High canopy	1	2	Remove
50503	8	0	Douglas-fir (<i>Pseudotsuga menziesii</i>)	Dead	3	3	Remove
50504	7,6	0	Douglas-fir (<i>Pseudotsuga menziesii</i>)	Dead	3	3	Remove
50505	11	9	Douglas-fir (<i>Pseudotsuga menziesii</i>)		1	1	Remove
50507	9	8	Douglas-fir (<i>Pseudotsuga menziesii</i>)	High canopy	1	2	Remove
50508	9	9	Douglas-fir (<i>Pseudotsuga menziesii</i>)	High canopy	1	2	Remove
50510	10	9	Douglas-fir (<i>Pseudotsuga menziesii</i>)		1	1	Remove
50513	9	7	Douglas-fir (<i>Pseudotsuga menziesii</i>)		1	1	Remove
50515	10	9	Douglas-fir (<i>Pseudotsuga menziesii</i>)		1	1	Remove
50516	9	6	Douglas-fir (<i>Pseudotsuga menziesii</i>)	High canopy	1	2	Remove
50519	10	6	Douglas-fir (<i>Pseudotsuga menziesii</i>)	High canopy	1	2	Remove
50520	9	8	Douglas-fir (<i>Pseudotsuga menziesii</i>)		1	1	Remove
50523	10	6	Douglas-fir (<i>Pseudotsuga menziesii</i>)	High canopy	1	2	Remove
50524	10	9	Douglas-fir (<i>Pseudotsuga menziesii</i>)		1	1	Remove
50526	8	6	Douglas-fir (<i>Pseudotsuga menziesii</i>)	High canopy	1	2	Remove
50528	10	6	Douglas-fir (<i>Pseudotsuga menziesii</i>)	High canopy	1	2	Remove
50529	8	6	Douglas-fir (<i>Pseudotsuga menziesii</i>)	High canopy	1	2	Remove

Detailed Tree Inventory for Autumn Sunrise

AKS Job No. 7454 - Evaluation Date: 2/1/2021 - 4/12/2021 - Evaluated by: BRK

Tree #	DBH (in.)	Avg. Crown Radius (ft)	Tree Species Common Name (<i>Scientific name</i>)	Comments	Health Rating*	Structure Rating**	Remove/Preserve
50531	9	0	Douglas-fir (<i>Pseudotsuga menziesii</i>)	Dead; Broken at 40'	3	3	Remove
50532	10	9	Douglas-fir (<i>Pseudotsuga menziesii</i>)		1	1	Remove
50533	10	9	Douglas-fir (<i>Pseudotsuga menziesii</i>)		1	1	Remove
50534	9	3	Douglas-fir (<i>Pseudotsuga menziesii</i>)	High canopy	1	2	Remove
50536	10	8	Douglas-fir (<i>Pseudotsuga menziesii</i>)		1	1	Remove
50537	9	8	Douglas-fir (<i>Pseudotsuga menziesii</i>)		1	1	Remove
50539	12	10	Douglas-fir (<i>Pseudotsuga menziesii</i>)		1	1	Remove
50540	11	13	Douglas-fir (<i>Pseudotsuga menziesii</i>)	Broken top; Sparse canopy	2	3	Remove
50541	8	4	Douglas-fir (<i>Pseudotsuga menziesii</i>)	High canopy	1	2	Remove
50543	9	3	Douglas-fir (<i>Pseudotsuga menziesii</i>)	High canopy; Crooked bole	1	2	Remove
50544	8	5	Douglas-fir (<i>Pseudotsuga menziesii</i>)	High canopy	1	2	Remove
50548	10	6	Douglas-fir (<i>Pseudotsuga menziesii</i>)	High canopy	1	2	Remove
50549	8	3	Douglas-fir (<i>Pseudotsuga menziesii</i>)	High canopy	1	2	Remove
50551	10	8	Douglas-fir (<i>Pseudotsuga menziesii</i>)		1	1	Remove
50552	11	9	Douglas-fir (<i>Pseudotsuga menziesii</i>)		1	1	Remove
50556	11	11	Douglas-fir (<i>Pseudotsuga menziesii</i>)		1	1	Remove
50557	9	6	Douglas-fir (<i>Pseudotsuga menziesii</i>)	High canopy	1	2	Remove
50558	9	0	Douglas-fir (<i>Pseudotsuga menziesii</i>)	Dead; Broken at 40'	3	3	Remove
50559	8	11	Douglas-fir (<i>Pseudotsuga menziesii</i>)	1-sided canopy (W); Lean (W); High canopy	1	2	Remove
50560	8	6	Douglas-fir (<i>Pseudotsuga menziesii</i>)	Broken top; Sparse canopy	2	3	Remove
50562	9	9	Douglas-fir (<i>Pseudotsuga menziesii</i>)		1	1	Remove
50565	9	11	Douglas-fir (<i>Pseudotsuga menziesii</i>)		1	1	Remove
50566	8	10	Douglas-fir (<i>Pseudotsuga menziesii</i>)	Broken top; Sparse canopy	2	3	Remove
50569	12	11	Douglas-fir (<i>Pseudotsuga menziesii</i>)		1	1	Remove
50570	10	10	Douglas-fir (<i>Pseudotsuga menziesii</i>)	1-sided canopy (S)	1	2	Remove
50571	8	11	Douglas-fir (<i>Pseudotsuga menziesii</i>)	1-sided canopy (S)	1	2	Remove
50577	33	20	Douglas-fir (<i>Pseudotsuga menziesii</i>)		1	1	Remove
50583	29	21	Douglas-fir (<i>Pseudotsuga menziesii</i>)		1	1	Remove
50584	8	10	Douglas-fir (<i>Pseudotsuga menziesii</i>)		1	1	Remove
50585	9	10	Douglas-fir (<i>Pseudotsuga menziesii</i>)		1	1	Remove
50589	8	8	Douglas-fir (<i>Pseudotsuga menziesii</i>)		1	1	Remove
50591	9	10	Douglas-fir (<i>Pseudotsuga menziesii</i>)	Broken top; Sparse canopy	3	2	Remove
50594	13	17	Douglas-fir (<i>Pseudotsuga menziesii</i>)	1-sided canopy (S)	1	2	Remove
50597	13	12	Douglas-fir (<i>Pseudotsuga menziesii</i>)		1	1	Remove
50598	12	13	Douglas-fir (<i>Pseudotsuga menziesii</i>)		1	1	Remove
50600	9	10	Douglas-fir (<i>Pseudotsuga menziesii</i>)		1	1	Remove
50601	14	12	Douglas-fir (<i>Pseudotsuga menziesii</i>)		1	1	Remove
50602	7,7	6	Willow (<i>Salix sp.</i>)		1	1	Remove
50603	8	0	Douglas-fir (<i>Pseudotsuga menziesii</i>)	Dead; Broken at 40'	3	3	Remove
50604	10	10	Douglas-fir (<i>Pseudotsuga menziesii</i>)		1	1	Remove
50610	14	12	Douglas-fir (<i>Pseudotsuga menziesii</i>)		1	1	Remove
50611	13	10	Douglas-fir (<i>Pseudotsuga menziesii</i>)		1	1	Remove
50612	8	6	Douglas-fir (<i>Pseudotsuga menziesii</i>)		1	1	Remove
50613	9	7	Douglas-fir (<i>Pseudotsuga menziesii</i>)		1	1	Remove
50615	12	8	Douglas-fir (<i>Pseudotsuga menziesii</i>)		1	1	Remove
50616	13	10	Douglas-fir (<i>Pseudotsuga menziesii</i>)		1	1	Remove
50619	10	7	Douglas-fir (<i>Pseudotsuga menziesii</i>)		1	1	Remove
50620	10	4	Douglas-fir (<i>Pseudotsuga menziesii</i>)	High canopy	1	2	Remove
50621	10	6	Douglas-fir (<i>Pseudotsuga menziesii</i>)	1-sided canopy (S)	1	2	Remove
50623	9	6	Douglas-fir (<i>Pseudotsuga menziesii</i>)	Broken top; Sparse canopy	2	3	Remove
50624	8	3	Douglas-fir (<i>Pseudotsuga menziesii</i>)	High canopy	1	2	Remove
50625	10	3	Douglas-fir (<i>Pseudotsuga menziesii</i>)	High canopy	1	2	Remove
50626	10	8	Douglas-fir (<i>Pseudotsuga menziesii</i>)		1	1	Remove
50627	10	5	Douglas-fir (<i>Pseudotsuga menziesii</i>)	High canopy	1	2	Remove
50630	10	8	Douglas-fir (<i>Pseudotsuga menziesii</i>)		1	1	Remove
50631	10	0	Douglas-fir (<i>Pseudotsuga menziesii</i>)	Dead; Broken at 40'	3	3	Remove
50632	11	10	Douglas-fir (<i>Pseudotsuga menziesii</i>)		1	1	Remove
50633	10	7	Douglas-fir (<i>Pseudotsuga menziesii</i>)		1	1	Remove
50636	8	6	Douglas-fir (<i>Pseudotsuga menziesii</i>)		1	1	Remove
50637	12	11	Douglas-fir (<i>Pseudotsuga menziesii</i>)		1	1	Remove
50638	12	10	Douglas-fir (<i>Pseudotsuga menziesii</i>)		1	1	Remove
50639	8	6	Douglas-fir (<i>Pseudotsuga menziesii</i>)		1	1	Remove
50640	10	12	Douglas-fir (<i>Pseudotsuga menziesii</i>)		1	1	Remove
50641	9	0	Douglas-fir (<i>Pseudotsuga menziesii</i>)	Dead; Broken at 20'	3	3	Remove
50644	8	0	Douglas-fir (<i>Pseudotsuga menziesii</i>)	Dead; Broken at 40'	3	3	Remove
50645	9	0	Douglas-fir (<i>Pseudotsuga menziesii</i>)	Dead; Broken at 40'	3	3	Remove
50646	11	8	Douglas-fir (<i>Pseudotsuga menziesii</i>)		1	1	Remove
50648	8	6	Douglas-fir (<i>Pseudotsuga menziesii</i>)	High canopy	1	2	Remove
50649	8	0	Douglas-fir (<i>Pseudotsuga menziesii</i>)	Dead; Broken at 30'	3	3	Remove

Detailed Tree Inventory for Autumn Sunrise

AKS Job No. 7454 - Evaluation Date: 2/1/2021 - 4/12/2021 - Evaluated by: BRK

Tree #	DBH (in.)	Avg. Crown Radius (ft)	Tree Species Common Name (<i>Scientific name</i>)	Comments	Health Rating*	Structure Rating**	Remove/Preserve
50650	10	0	Douglas-fir (<i>Pseudotsuga menziesii</i>)	Dead; Broken at 40'	3	3	Remove
50654	10	10	Douglas-fir (<i>Pseudotsuga menziesii</i>)		1	1	Remove
50655	8	4	Douglas-fir (<i>Pseudotsuga menziesii</i>)	High canopy	1	2	Remove
50656	11	9	Douglas-fir (<i>Pseudotsuga menziesii</i>)		1	1	Remove
50658	11	6	Douglas-fir (<i>Pseudotsuga menziesii</i>)	High canopy	1	1	Remove
50659	12	15	Douglas-fir (<i>Pseudotsuga menziesii</i>)	1-sided canopy (S)	1	2	Remove
50661	10	13	Douglas-fir (<i>Pseudotsuga menziesii</i>)		1	1	Remove
50662	12	10	Douglas-fir (<i>Pseudotsuga menziesii</i>)		1	1	Remove
50665	12	11	Douglas-fir (<i>Pseudotsuga menziesii</i>)		1	1	Remove
50666	9	6	Douglas-fir (<i>Pseudotsuga menziesii</i>)	Broken top; Sparse canopy	2	3	Remove
50667	9	7	Douglas-fir (<i>Pseudotsuga menziesii</i>)		1	1	Remove
50668	10	7	Douglas-fir (<i>Pseudotsuga menziesii</i>)		1	1	Remove
50669	9	6	Douglas-fir (<i>Pseudotsuga menziesii</i>)	Broken top; Sparse canopy	2	3	Remove
50670	9	8	Douglas-fir (<i>Pseudotsuga menziesii</i>)		1	1	Remove
50674	9	8	Douglas-fir (<i>Pseudotsuga menziesii</i>)		1	1	Remove
50675	28	23	Douglas-fir (<i>Pseudotsuga menziesii</i>)	Crooked top	1	2	Remove
50676	10	11	Douglas-fir (<i>Pseudotsuga menziesii</i>)	1-sided canopy (S)	1	2	Remove
50677	12	7	Douglas-fir (<i>Pseudotsuga menziesii</i>)		1	1	Remove
50680	7,6	4	Douglas-fir (<i>Pseudotsuga menziesii</i>)	Codominant with included bark; High canopy; Sparse canopy	2	2	Remove
50681	12	11	Douglas-fir (<i>Pseudotsuga menziesii</i>)		1	1	Remove
50684	8	5	Douglas-fir (<i>Pseudotsuga menziesii</i>)	High canopy	1	2	Remove
50686	15	15	Cherry (<i>Prunus sp.</i>)	Failed codominant stem	2	2	Remove
50688	8	17	Cherry (<i>Prunus sp.</i>)	Lean (S)	1	2	Remove
50689	8,10	16	Cherry (<i>Prunus sp.</i>)	1-sided canopy (S)	1	2	Remove
50690	10	8	Douglas-fir (<i>Pseudotsuga menziesii</i>)	High canopy	1	2	Remove
50693	8	0	Douglas-fir (<i>Pseudotsuga menziesii</i>)	Dead; Broken at 40'	3	3	Remove
50695	8	0	Douglas-fir (<i>Pseudotsuga menziesii</i>)	Dead; Broken at 40''	3	3	Remove
50696	9,13	18	Cherry (<i>Prunus sp.</i>)		1	1	Remove
50698	9	10	Cherry (<i>Prunus sp.</i>)		1	1	Remove
50700	9	8	Douglas-fir (<i>Pseudotsuga menziesii</i>)		1	1	Remove
50702	8	6	Douglas-fir (<i>Pseudotsuga menziesii</i>)		1	1	Remove
50703	9	6	Douglas-fir (<i>Pseudotsuga menziesii</i>)		1	1	Remove
50705	19,26	19	Douglas-fir (<i>Pseudotsuga menziesii</i>)	Codominant base with included bark	1	2	Remove
50715	26	20	Douglas-fir (<i>Pseudotsuga menziesii</i>)	Many broken branches; Sparse canopy; High canopy	2	2	Remove
50716	25	18	Douglas-fir (<i>Pseudotsuga menziesii</i>)		1	1	Remove
50717	24	24	Douglas-fir (<i>Pseudotsuga menziesii</i>)	1-sided canopy (N)	1	2	Remove
50718	10	10	Douglas-fir (<i>Pseudotsuga menziesii</i>)	Broken top; Sparse canopy	2	3	Remove
50719	12	10	Douglas-fir (<i>Pseudotsuga menziesii</i>)		1	1	Remove
50721	8	5	Douglas-fir (<i>Pseudotsuga menziesii</i>)	High canopy	1	2	Remove
50729	10,7	15	Cherry (<i>Prunus sp.</i>)	Codominant; Crooked bole	1	2	Remove
50730	26	20	Douglas-fir (<i>Pseudotsuga menziesii</i>)	Broken branches on east side	1	2	Remove
50732	26	20	Douglas-fir (<i>Pseudotsuga menziesii</i>)		1	1	Remove
50736	10	12	Douglas-fir (<i>Pseudotsuga menziesii</i>)		1	1	Remove
50738	9	13	Douglas-fir (<i>Pseudotsuga menziesii</i>)		1	1	Remove
50739	8	8	Douglas-fir (<i>Pseudotsuga menziesii</i>)	Broken top; Sparse canopy	2	3	Remove
50743	10	9	Douglas-fir (<i>Pseudotsuga menziesii</i>)	Broken top; Sparse canopy	2	3	Remove
50745	12	11	Douglas-fir (<i>Pseudotsuga menziesii</i>)		1	1	Remove
50746	9	0	Douglas-fir (<i>Pseudotsuga menziesii</i>)	Dead; Broken at 30'	3	3	Remove
50750	29	19	Douglas-fir (<i>Pseudotsuga menziesii</i>)	Codominant with included bark	1	2	Remove
50751	8	7	Douglas-fir (<i>Pseudotsuga menziesii</i>)	Broken top; Sparse canopy	2	3	Remove
50752	10	9	Douglas-fir (<i>Pseudotsuga menziesii</i>)		1	1	Remove
50754	12	9	Douglas-fir (<i>Pseudotsuga menziesii</i>)	High canopy	1	2	Remove
50755	11	8	Douglas-fir (<i>Pseudotsuga menziesii</i>)		1	1	Remove
50757	10	7	Douglas-fir (<i>Pseudotsuga menziesii</i>)		1	1	Remove
50758	9	8	Douglas-fir (<i>Pseudotsuga menziesii</i>)		1	1	Remove
50759	9	7	Douglas-fir (<i>Pseudotsuga menziesii</i>)		1	1	Remove
50761	10	8	Douglas-fir (<i>Pseudotsuga menziesii</i>)	1-sided canopy (W)	1	2	Remove
50763	9	8	Douglas-fir (<i>Pseudotsuga menziesii</i>)		1	1	Remove
50765	11	13	Douglas-fir (<i>Pseudotsuga menziesii</i>)		1	1	Remove
50766	10	9	Douglas-fir (<i>Pseudotsuga menziesii</i>)	Broken top; Sparse canopy	2	3	Remove
50768	13	11	Douglas-fir (<i>Pseudotsuga menziesii</i>)		1	1	Remove
50770	8	10	Douglas-fir (<i>Pseudotsuga menziesii</i>)	1-sided canopy (S); Damaged by failed trees	2	2	Remove
50771	12	11	Douglas-fir (<i>Pseudotsuga menziesii</i>)		1	1	Remove
50772	13	13	Douglas-fir (<i>Pseudotsuga menziesii</i>)	Crooked bole; 1-sided canopy (S)	1	2	Remove
50773	14	14	Douglas-fir (<i>Pseudotsuga menziesii</i>)	1-sided canopy (S)	1	2	Remove
50775	11	11	Douglas-fir (<i>Pseudotsuga menziesii</i>)		1	1	Remove
50776	10	8	Douglas-fir (<i>Pseudotsuga menziesii</i>)		1	1	Remove
50778	8	8	Cherry (<i>Prunus sp.</i>)	Exposed roots (W)	1	1	Remove

Detailed Tree Inventory for Autumn Sunrise

AKS Job No. 7454 - Evaluation Date: 2/1/2021 - 4/12/2021 - Evaluated by: BRK

Tree #	DBH (in.)	Avg. Crown Radius (ft)	Tree Species Common Name (Scientific name)	Comments	Health Rating*	Structure Rating**	Remove/Preserve
50779	10	9	Douglas-fir (<i>Pseudotsuga menziesii</i>)		1	1	Remove
50781	10	6	Douglas-fir (<i>Pseudotsuga menziesii</i>)	High canopy	1	2	Remove
50782	10	7	Douglas-fir (<i>Pseudotsuga menziesii</i>)	High canopy	1	2	Remove
50784	10	10	Douglas-fir (<i>Pseudotsuga menziesii</i>)	Broken top; Sparse canopy	2	3	Remove
50785	8	5	Douglas-fir (<i>Pseudotsuga menziesii</i>)	High canopy	1	2	Remove
50786	10	4	Douglas-fir (<i>Pseudotsuga menziesii</i>)	High canopy	1	2	Remove
50799	13	12	Douglas-fir (<i>Pseudotsuga menziesii</i>)		1	1	Remove
50800	13	12	Douglas-fir (<i>Pseudotsuga menziesii</i>)		1	1	Remove
50803	9	15	Douglas-fir (<i>Pseudotsuga menziesii</i>)	Lean (S)	1	2	Remove
50805	12	10	Douglas-fir (<i>Pseudotsuga menziesii</i>)		1	1	Remove
50816	10	10	Willow (<i>Salix sp.</i>)		1	1	Remove
50817	7,6	20	Willow (<i>Salix sp.</i>)	Broken branches; Lean (E)	1	2	Remove
50818	12	15	Douglas-fir (<i>Pseudotsuga menziesii</i>)		1	1	Remove
50819	8	7	Douglas-fir (<i>Pseudotsuga menziesii</i>)	High canopy; Lean (W)	1	2	Remove
50820	10	9	Douglas-fir (<i>Pseudotsuga menziesii</i>)		1	1	Remove
50822	8	7	Douglas-fir (<i>Pseudotsuga menziesii</i>)		1	1	Remove
50823	8	6	Douglas-fir (<i>Pseudotsuga menziesii</i>)	High canopy	1	2	Remove
50824	13	16	Douglas-fir (<i>Pseudotsuga menziesii</i>)	1-sided canopy (S)	1	2	Remove
50825	33	17	Douglas-fir (<i>Pseudotsuga menziesii</i>)	Sweep; Crooked bole	1	2	Remove
50826	13	10	Douglas-fir (<i>Pseudotsuga menziesii</i>)		1	1	Remove
50828	9	7	Douglas-fir (<i>Pseudotsuga menziesii</i>)		1	1	Remove
50831	13	15	Douglas-fir (<i>Pseudotsuga menziesii</i>)	1-sided canopy (S)	1	2	Remove
50832	9	6	Douglas-fir (<i>Pseudotsuga menziesii</i>)	High canopy	1	2	Remove
50833	9	8	Douglas-fir (<i>Pseudotsuga menziesii</i>)	Broken top; Sparse canopy	2	3	Remove
50834	10	16	Douglas-fir (<i>Pseudotsuga menziesii</i>)	1-sided canopy (S)	1	2	Remove
50837	14	17	Douglas-fir (<i>Pseudotsuga menziesii</i>)	1-sided canopy (S)	1	2	Remove
50838	11	17	Douglas-fir (<i>Pseudotsuga menziesii</i>)	1-sided canopy (SW)	1	2	Remove
50840	10	10	Douglas-fir (<i>Pseudotsuga menziesii</i>)		1	1	Remove
50842	11	13	Douglas-fir (<i>Pseudotsuga menziesii</i>)		1	1	Remove
50843	12	10	Douglas-fir (<i>Pseudotsuga menziesii</i>)		1	1	Remove
50844	8	8	Douglas-fir (<i>Pseudotsuga menziesii</i>)		1	1	Remove
50846	10	8	Douglas-fir (<i>Pseudotsuga menziesii</i>)		1	1	Remove
50848	10	13	Douglas-fir (<i>Pseudotsuga menziesii</i>)		1	1	Remove
50855	8	4	Douglas-fir (<i>Pseudotsuga menziesii</i>)	High canopy	1	2	Remove
50861	12	11	Douglas-fir (<i>Pseudotsuga menziesii</i>)		1	1	Remove
50862	11	9	Douglas-fir (<i>Pseudotsuga menziesii</i>)		1	1	Remove
50865	10	7	Douglas-fir (<i>Pseudotsuga menziesii</i>)	High canopy	1	2	Remove
50866	8	6	Douglas-fir (<i>Pseudotsuga menziesii</i>)	High canopy	1	2	Remove
50867	12	10	Douglas-fir (<i>Pseudotsuga menziesii</i>)		1	1	Remove
50871	13	13	Douglas-fir (<i>Pseudotsuga menziesii</i>)		1	1	Remove
50872	8	0	European White Birch (<i>Betula pendula</i>)	Dead; Broken at 30'	3	3	Remove
50878	11	9	Douglas-fir (<i>Pseudotsuga menziesii</i>)		1	1	Remove
50883	9	11	Cherry (<i>Prunus sp.</i>)	1-sided canopy (S); Codominant with included bark	1	2	Remove
50886	8,7	11	Cherry (<i>Prunus sp.</i>)		1	1	Remove
50887	12	10	Douglas-fir (<i>Pseudotsuga menziesii</i>)		1	1	Remove
50891	12	12	Douglas-fir (<i>Pseudotsuga menziesii</i>)		1	1	Remove
50892	12	10	Douglas-fir (<i>Pseudotsuga menziesii</i>)		1	1	Remove
50895	13	12	Douglas-fir (<i>Pseudotsuga menziesii</i>)		1	1	Remove
50896	8	8	Douglas-fir (<i>Pseudotsuga menziesii</i>)		1	1	Remove
50897	8	7	Douglas-fir (<i>Pseudotsuga menziesii</i>)	Broken top; Sparse canopy	2	3	Remove
50898	9	8	Douglas-fir (<i>Pseudotsuga menziesii</i>)		1	1	Remove
50900	8	6	Douglas-fir (<i>Pseudotsuga menziesii</i>)		1	1	Remove
50902	10	12	Douglas-fir (<i>Pseudotsuga menziesii</i>)		1	1	Remove
50903	8	0	Douglas-fir (<i>Pseudotsuga menziesii</i>)	Dead	3	3	Remove
50904	9	0	Douglas-fir (<i>Pseudotsuga menziesii</i>)	Dead; Broken at 40'	3	3	Remove
50906	9	4	Douglas-fir (<i>Pseudotsuga menziesii</i>)	High canopy	1	2	Remove
50907	9	12	Douglas-fir (<i>Pseudotsuga menziesii</i>)		1	1	Remove
50912	11	6	Douglas-fir (<i>Pseudotsuga menziesii</i>)	High canopy; Sparse canopy	2	2	Remove
50913	11	14	Douglas-fir (<i>Pseudotsuga menziesii</i>)	1-sided canopy (E)	1	2	Remove
50914	12	12	Douglas-fir (<i>Pseudotsuga menziesii</i>)	High canopy	1	2	Remove
50915	13	7	Douglas-fir (<i>Pseudotsuga menziesii</i>)		1	1	Remove
50917	9	7	Douglas-fir (<i>Pseudotsuga menziesii</i>)		1	1	Remove
50918	12	13	Douglas-fir (<i>Pseudotsuga menziesii</i>)		1	1	Remove
50920	12	9	Douglas-fir (<i>Pseudotsuga menziesii</i>)	Broken top; Sparse canopy	2	3	Remove
50921	11	9	Douglas-fir (<i>Pseudotsuga menziesii</i>)		1	1	Remove
50922	11	8	Douglas-fir (<i>Pseudotsuga menziesii</i>)		1	1	Remove
50924	12	12	Douglas-fir (<i>Pseudotsuga menziesii</i>)	Broken top	2	3	Remove
50927	9	8	Douglas-fir (<i>Pseudotsuga menziesii</i>)		1	1	Remove
50928	10	6	Douglas-fir (<i>Pseudotsuga menziesii</i>)	High canopy	1	2	Remove

Detailed Tree Inventory for Autumn Sunrise

AKS Job No. 7454 - Evaluation Date: 2/1/2021 - 4/12/2021 - Evaluated by: BRK

Tree #	DBH (in.)	Avg. Crown Radius (ft)	Tree Species Common Name (Scientific name)	Comments	Health Rating*	Structure Rating**	Remove/Preserve
50929	13	13	Douglas-fir (<i>Pseudotsuga menziesii</i>)		1	1	Remove
50932	10	9	Douglas-fir (<i>Pseudotsuga menziesii</i>)		1	1	Remove
50934	8	8	Douglas-fir (<i>Pseudotsuga menziesii</i>)		1	1	Remove
50936	13	10	Douglas-fir (<i>Pseudotsuga menziesii</i>)		1	1	Remove
50937	12	11	Douglas-fir (<i>Pseudotsuga menziesii</i>)		1	1	Remove
50938	8	6	Douglas-fir (<i>Pseudotsuga menziesii</i>)	Broken top; Sparse canopy	2	3	Remove
50939	8	5	Douglas-fir (<i>Pseudotsuga menziesii</i>)	High canopy	1	2	Remove
50940	9	9	Douglas-fir (<i>Pseudotsuga menziesii</i>)		1	1	Remove
50941	10	10	Douglas-fir (<i>Pseudotsuga menziesii</i>)		1	1	Remove
50944	9	5	Douglas-fir (<i>Pseudotsuga menziesii</i>)	High canopy	1	2	Remove
50945	8	6	Douglas-fir (<i>Pseudotsuga menziesii</i>)	High canopy	1	2	Remove
50946	9	3	Douglas-fir (<i>Pseudotsuga menziesii</i>)	High canopy; Sparse canopy	2	2	Remove
50947	10	11	Douglas-fir (<i>Pseudotsuga menziesii</i>)		1	1	Remove
50949	8	0	Douglas-fir (<i>Pseudotsuga menziesii</i>)	Dead	3	3	Remove
50950	10	6	Douglas-fir (<i>Pseudotsuga menziesii</i>)		1	1	Remove
50952	11	8	Douglas-fir (<i>Pseudotsuga menziesii</i>)		1	1	Remove
50954	13	10	Douglas-fir (<i>Pseudotsuga menziesii</i>)		1	1	Remove
50956	11	7	Douglas-fir (<i>Pseudotsuga menziesii</i>)		1	1	Remove
50957	12	10	Douglas-fir (<i>Pseudotsuga menziesii</i>)		1	1	Remove
50958	8	7	Douglas-fir (<i>Pseudotsuga menziesii</i>)		1	1	Remove
50960	13	10	Douglas-fir (<i>Pseudotsuga menziesii</i>)		1	1	Remove
50962	10	8	Douglas-fir (<i>Pseudotsuga menziesii</i>)		1	1	Remove
50963	9	12	Douglas-fir (<i>Pseudotsuga menziesii</i>)	1-sided canopy (S)	1	2	Remove
50965	9	7	Douglas-fir (<i>Pseudotsuga menziesii</i>)		1	1	Remove
50966	9	11	Cherry (<i>Prunus sp.</i>)		1	1	Remove
50969	10,11	11	Cherry (<i>Prunus sp.</i>)		1	1	Remove
50970	9	11	Douglas-fir (<i>Pseudotsuga menziesii</i>)	Lean (N); High canopy	1	2	Remove
50971	10	10	Douglas-fir (<i>Pseudotsuga menziesii</i>)		1	1	Remove
50972	10	6	Douglas-fir (<i>Pseudotsuga menziesii</i>)		1	1	Remove
50973	12	9	Douglas-fir (<i>Pseudotsuga menziesii</i>)		1	1	Remove
50975	13	15	Douglas-fir (<i>Pseudotsuga menziesii</i>)	1-sided canopy (S)	1	2	Remove
50978	9	10	Douglas-fir (<i>Pseudotsuga menziesii</i>)	Crooked; 1-sided canopy (S)	1	2	Remove
50979	12	12	Douglas-fir (<i>Pseudotsuga menziesii</i>)		1	1	Remove
50981	12	8	Douglas-fir (<i>Pseudotsuga menziesii</i>)		1	1	Remove
50983	14	7	Douglas-fir (<i>Pseudotsuga menziesii</i>)		1	1	Remove
50984	10	7	Douglas-fir (<i>Pseudotsuga menziesii</i>)		1	1	Remove
50989	15	11	Douglas-fir (<i>Pseudotsuga menziesii</i>)		1	1	Remove
50990	8	9	Cherry (<i>Prunus sp.</i>)		1	1	Remove
50993	8	13	Cherry (<i>Prunus sp.</i>)	1-sided canopy (S)	1	2	Remove
50996	12	10	Douglas-fir (<i>Pseudotsuga menziesii</i>)	1-sided canopy (S)	1	2	Remove
50997	13	8	Douglas-fir (<i>Pseudotsuga menziesii</i>)		1	1	Remove
50998	9	10	Cherry (<i>Prunus sp.</i>)		1	1	Remove
51012	7,7	16	Bigleaf Maple (<i>Acer macrophyllum</i>)	Codominant with included bark; 1-sided canopy (S)	1	2	Remove
51013	11	10	Douglas-fir (<i>Pseudotsuga menziesii</i>)	1-sided canopy (S)	1	2	Remove
51014	11	14	Douglas-fir (<i>Pseudotsuga menziesii</i>)	1-sided canopy (S)	1	2	Remove
51016	13	13	Douglas-fir (<i>Pseudotsuga menziesii</i>)	1-sided canopy (S)	1	2	Remove
51019	30,9	28	Bigleaf Maple (<i>Acer macrophyllum</i>)		1	1	Remove
51024	13	13	Douglas-fir (<i>Pseudotsuga menziesii</i>)		1	1	Remove
51025	10	7	Douglas-fir (<i>Pseudotsuga menziesii</i>)		1	1	Remove
51026	11	8	Douglas-fir (<i>Pseudotsuga menziesii</i>)		1	1	Remove
51029	8	10	Cherry (<i>Prunus sp.</i>)		1	1	Remove
51031	8,6	11	Cherry (<i>Prunus sp.</i>)		1	1	Remove
51033	8	15	Cherry (<i>Prunus sp.</i>)	Lean (S); 1-sided canopy (S)	1	2	Remove
51035	13	15	Douglas-fir (<i>Pseudotsuga menziesii</i>)		1	1	Remove
51036	12	7	Douglas-fir (<i>Pseudotsuga menziesii</i>)		1	1	Remove
51037	13	12	Douglas-fir (<i>Pseudotsuga menziesii</i>)		1	1	Remove
51038	10	7	Douglas-fir (<i>Pseudotsuga menziesii</i>)		1	1	Remove
51039	13	12	Douglas-fir (<i>Pseudotsuga menziesii</i>)	1-sided canopy (S)	1	2	Remove
51040	8	6	Douglas-fir (<i>Pseudotsuga menziesii</i>)	Top lean (N)	1	2	Remove
51041	9	8	Douglas-fir (<i>Pseudotsuga menziesii</i>)		1	1	Remove
51045	15	15	Douglas-fir (<i>Pseudotsuga menziesii</i>)		1	1	Remove
51047	22	23	Douglas-fir (<i>Pseudotsuga menziesii</i>)	Bulges; Crooked bole; 1-sided canopy (S)	2	2	Remove
51048	22	14	Douglas-fir (<i>Pseudotsuga menziesii</i>)	Crooked bole; 1-sided canopy (S)	1	2	Remove
51050	13,21	17	Douglas-fir (<i>Pseudotsuga menziesii</i>)	Codominant base; 1 bole crooked	1	2	Remove
51051	13	15	Douglas-fir (<i>Pseudotsuga menziesii</i>)	1-sided canopy (E)	1	2	Remove
51052	13	15	Douglas-fir (<i>Pseudotsuga menziesii</i>)	1-sided canopy (W)	1	2	Remove
51053	49	25	Douglas-fir (<i>Pseudotsuga menziesii</i>)		1	1	Remove
51056	9	6	Douglas-fir (<i>Pseudotsuga menziesii</i>)		1	1	Remove
51058	11	9	Douglas-fir (<i>Pseudotsuga menziesii</i>)		1	1	Remove

Detailed Tree Inventory for Autumn Sunrise

AKS Job No. 7454 - Evaluation Date: 2/1/2021 - 4/12/2021 - Evaluated by: BRK

Tree #	DBH (in.)	Avg. Crown Radius (ft)	Tree Species Common Name (<i>Scientific name</i>)	Comments	Health Rating*	Structure Rating**	Remove/Preserve
51059	8	7	Douglas-fir (<i>Pseudotsuga menziesii</i>)	High canopy	1	2	Remove
51060	10	11	Douglas-fir (<i>Pseudotsuga menziesii</i>)	1-sided canopy (S)	1	2	Remove
51062	9	8	Douglas-fir (<i>Pseudotsuga menziesii</i>)		1	1	Remove
51063	10	12	Douglas-fir (<i>Pseudotsuga menziesii</i>)		1	1	Remove
51064	8	11	Douglas-fir (<i>Pseudotsuga menziesii</i>)		1	1	Remove
51069	8	0	Douglas-fir (<i>Pseudotsuga menziesii</i>)	Dead; Broken at 40'	3	3	Remove
51071	8	6	Douglas-fir (<i>Pseudotsuga menziesii</i>)		1	1	Remove
51072	9	0	Douglas-fir (<i>Pseudotsuga menziesii</i>)	Dead; Broken at 40'	3	3	Remove
51078	8	7	Douglas-fir (<i>Pseudotsuga menziesii</i>)		1	1	Remove
51081	27	20	Douglas-fir (<i>Pseudotsuga menziesii</i>)		1	1	Remove
51084	26	20	Douglas-fir (<i>Pseudotsuga menziesii</i>)		1	1	Remove
51089	9	12	Douglas-fir (<i>Pseudotsuga menziesii</i>)	1-sided canopy (W)	1	2	Remove
51090	8	10	Douglas-fir (<i>Pseudotsuga menziesii</i>)	Broken top; Sparse canopy	2	3	Remove
51094	12	14	Douglas-fir (<i>Pseudotsuga menziesii</i>)	1-sided canopy (S)	1	2	Remove
51095	11	10	Douglas-fir (<i>Pseudotsuga menziesii</i>)		1	1	Remove
51098	8	7	Douglas-fir (<i>Pseudotsuga menziesii</i>)		1	1	Remove
51099	8	8	Douglas-fir (<i>Pseudotsuga menziesii</i>)	1-sided canopy (W)	1	2	Remove
51101	13	12	Douglas-fir (<i>Pseudotsuga menziesii</i>)	Deformed bole	1	2	Remove
51103	8	8	Douglas-fir (<i>Pseudotsuga menziesii</i>)		1	1	Remove
51104	9	6	Douglas-fir (<i>Pseudotsuga menziesii</i>)		1	1	Remove
51105	9	10	Douglas-fir (<i>Pseudotsuga menziesii</i>)		1	1	Remove
51110	11	10	Douglas-fir (<i>Pseudotsuga menziesii</i>)		1	1	Remove
51113	8	17	Willow (<i>Salix sp.</i>)	1-sided canopy (W)	1	2	Remove
51114	8	6	Douglas-fir (<i>Pseudotsuga menziesii</i>)		1	1	Remove
51115	8	7	Douglas-fir (<i>Pseudotsuga menziesii</i>)		1	1	Remove
51116	9	9	Douglas-fir (<i>Pseudotsuga menziesii</i>)		1	1	Remove
51118	8	11	Willow (<i>Salix sp.</i>)	Large cavity with decay	2	2	Remove
51120	12	11	Douglas-fir (<i>Pseudotsuga menziesii</i>)		1	1	Remove
51121	12	11	Douglas-fir (<i>Pseudotsuga menziesii</i>)		1	1	Remove
51125	8	10	Douglas-fir (<i>Pseudotsuga menziesii</i>)	1-sided canopy (W)	1	2	Remove
51127	10	13	Douglas-fir (<i>Pseudotsuga menziesii</i>)		1	1	Remove
51128	10	13	Douglas-fir (<i>Pseudotsuga menziesii</i>)		1	1	Remove
51130	11	12	Douglas-fir (<i>Pseudotsuga menziesii</i>)		1	1	Remove
51132	15	13	Douglas-fir (<i>Pseudotsuga menziesii</i>)		1	1	Remove
51135	18	19	Douglas-fir (<i>Pseudotsuga menziesii</i>)	Broken top; Sparse canopy; 1-sided canopy (W)	2	3	Remove
51143	7,7	15	Willow (<i>Salix sp.</i>)	1-sided canopy (W); Broken branches	1	2	Remove
51149	9,8,7	18	Willow (<i>Salix sp.</i>)	1-sided canopy (W)	1	2	Remove
51155	8,9	14	Willow (<i>Salix sp.</i>)	1-sided canopy (W); Broken branches	1	2	Remove
51160	6,6,7	11	Willow (<i>Salix sp.</i>)	Clustered base; Broken limbs	1	2	Remove
51161	7,6	10	Willow (<i>Salix sp.</i>)	Broken limbs; Broken tops	2	2	Remove
51163	24	16	Douglas-fir (<i>Pseudotsuga menziesii</i>)	Large cavity with conks inside	2	3	Remove
51166	8,7,6	0	Willow (<i>Salix sp.</i>)	Dead	3	3	Remove
51168	11	10	Douglas-fir (<i>Pseudotsuga menziesii</i>)	Crooked bole	1	2	Remove
51172	14	10	Douglas-fir (<i>Pseudotsuga menziesii</i>)		1	1	Remove
51173	10	10	Douglas-fir (<i>Pseudotsuga menziesii</i>)	1-sided canopy (N)	1	2	Remove
51176	9	9	Douglas-fir (<i>Pseudotsuga menziesii</i>)		1	1	Remove
51177	10	9	Douglas-fir (<i>Pseudotsuga menziesii</i>)		1	1	Remove
51178	9	8	Douglas-fir (<i>Pseudotsuga menziesii</i>)		1	1	Remove
51182	10	7	Douglas-fir (<i>Pseudotsuga menziesii</i>)		1	1	Remove
51183	9	6	Douglas-fir (<i>Pseudotsuga menziesii</i>)	Broken top; Sparse canopy	2	3	Remove
51184	8	6	Douglas-fir (<i>Pseudotsuga menziesii</i>)	High canopy	1	2	Remove
51186	8	7	Douglas-fir (<i>Pseudotsuga menziesii</i>)		1	1	Remove
51188	10	9	Douglas-fir (<i>Pseudotsuga menziesii</i>)		1	1	Remove
51193	9	6	Douglas-fir (<i>Pseudotsuga menziesii</i>)		1	1	Remove
51194	11	7	Douglas-fir (<i>Pseudotsuga menziesii</i>)		1	1	Remove
51195	8	7	Douglas-fir (<i>Pseudotsuga menziesii</i>)		1	1	Remove
51197	10	9	Douglas-fir (<i>Pseudotsuga menziesii</i>)		1	1	Remove
51198	11	11	Douglas-fir (<i>Pseudotsuga menziesii</i>)		1	1	Remove
51199	11	12	Douglas-fir (<i>Pseudotsuga menziesii</i>)	1-sided canopy (W)	1	2	Remove
51201	10	12	Douglas-fir (<i>Pseudotsuga menziesii</i>)	1-sided canopy (W)	1	2	Remove
51203	15	12	Douglas-fir (<i>Pseudotsuga menziesii</i>)		1	1	Remove
51204	10	9	Douglas-fir (<i>Pseudotsuga menziesii</i>)		1	1	Remove
51206	8	8	Douglas-fir (<i>Pseudotsuga menziesii</i>)		1	1	Remove
51207	10	10	Douglas-fir (<i>Pseudotsuga menziesii</i>)		1	1	Remove
51208	10	11	Douglas-fir (<i>Pseudotsuga menziesii</i>)	Broken branches; Epicormic sprouts	2	1	Remove
51209	9	6	Douglas-fir (<i>Pseudotsuga menziesii</i>)	High canopy	1	2	Remove
51211	8	0	Douglas-fir (<i>Pseudotsuga menziesii</i>)	Dead; Broken at 40'	3	3	Remove
51213	8	7	Douglas-fir (<i>Pseudotsuga menziesii</i>)		1	1	Remove
51214	28	20	Douglas-fir (<i>Pseudotsuga menziesii</i>)		1	1	Remove

Detailed Tree Inventory for Autumn Sunrise

AKS Job No. 7454 - Evaluation Date: 2/1/2021 - 4/12/2021 - Evaluated by: BRK

Tree #	DBH (in.)	Avg. Crown Radius (ft)	Tree Species Common Name (Scientific name)	Comments	Health Rating*	Structure Rating**	Remove/Preserve
51215	10	9	Douglas-fir (<i>Pseudotsuga menziesii</i>)		1	1	Remove
51216	11	11	Douglas-fir (<i>Pseudotsuga menziesii</i>)		1	1	Remove
51218	9	7	Douglas-fir (<i>Pseudotsuga menziesii</i>)		1	1	Remove
51219	11	11	Douglas-fir (<i>Pseudotsuga menziesii</i>)		1	1	Remove
51220	10	9	Douglas-fir (<i>Pseudotsuga menziesii</i>)	Crooked bole	1	2	Remove
51221	9	11	Douglas-fir (<i>Pseudotsuga menziesii</i>)	1-sided canopy (W)	1	2	Remove
51224	8	10	Douglas-fir (<i>Pseudotsuga menziesii</i>)		1	1	Remove
51225	22	19	Douglas-fir (<i>Pseudotsuga menziesii</i>)	Codominant top	1	2	Remove
51228	6,6	10	Cherry (<i>Prunus sp.</i>)	Clustered base	1	2	Remove
51233	16	14	Douglas-fir (<i>Pseudotsuga menziesii</i>)		1	1	Remove
51236	12,6	19	Cherry (<i>Prunus sp.</i>)	1-sided canopy (W)	1	2	Remove
51237	8,7,7	13	Cherry (<i>Prunus sp.</i>)	Broken tops on several stems	2	2	Remove
51239	8,7,7,6	17	Cherry (<i>Prunus sp.</i>)	Codominant base	1	2	Remove
51243	11	16	Douglas-fir (<i>Pseudotsuga menziesii</i>)	Codominant top; 1-sided canopy (W)	1	2	Remove
51247	12	17	Douglas-fir (<i>Pseudotsuga menziesii</i>)	1-sided canopy (W)	1	2	Remove
51249	12	11	Douglas-fir (<i>Pseudotsuga menziesii</i>)		1	1	Remove
51250	10	13	Douglas-fir (<i>Pseudotsuga menziesii</i>)	1-sided canopy (W)	1	2	Remove
51252	13	12	Douglas-fir (<i>Pseudotsuga menziesii</i>)	1-sided canopy (W)	1	2	Remove
51256	11	13	Douglas-fir (<i>Pseudotsuga menziesii</i>)	1-sided canopy (W)	1	2	Remove
51257	10	8	Douglas-fir (<i>Pseudotsuga menziesii</i>)		1	1	Remove
51258	8	7	Douglas-fir (<i>Pseudotsuga menziesii</i>)		1	1	Remove
51260	9	6	Douglas-fir (<i>Pseudotsuga menziesii</i>)		1	1	Remove
51261	11	8	Douglas-fir (<i>Pseudotsuga menziesii</i>)		1	1	Remove
51263	9	6	Douglas-fir (<i>Pseudotsuga menziesii</i>)		1	1	Remove
51264	10	9	Douglas-fir (<i>Pseudotsuga menziesii</i>)		1	1	Remove
51268	32	20	Douglas-fir (<i>Pseudotsuga menziesii</i>)		1	1	Remove
51269	8	7	Douglas-fir (<i>Pseudotsuga menziesii</i>)		1	1	Remove
51270	8	6	Douglas-fir (<i>Pseudotsuga menziesii</i>)		1	1	Remove
51271	36	22	Douglas-fir (<i>Pseudotsuga menziesii</i>)	Crooked bole	1	2	Remove
51273	9	9	Douglas-fir (<i>Pseudotsuga menziesii</i>)		1	1	Remove
51275	8	10	Douglas-fir (<i>Pseudotsuga menziesii</i>)		1	1	Remove
51276	10	9	Douglas-fir (<i>Pseudotsuga menziesii</i>)		1	1	Remove
51278	12	11	Douglas-fir (<i>Pseudotsuga menziesii</i>)		1	1	Remove
51279	9	11	Douglas-fir (<i>Pseudotsuga menziesii</i>)	1-sided canopy (W)	1	2	Remove
51280	10	10	Douglas-fir (<i>Pseudotsuga menziesii</i>)	1-sided canopy (W)	1	2	Remove
51282	10	10	Douglas-fir (<i>Pseudotsuga menziesii</i>)	1-sided canopy (W)	1	2	Remove
51283	10	12	Douglas-fir (<i>Pseudotsuga menziesii</i>)	1-sided canopy (W)	1	2	Remove
51285	11	10	Douglas-fir (<i>Pseudotsuga menziesii</i>)		1	1	Remove
51287	9	11	Douglas-fir (<i>Pseudotsuga menziesii</i>)	1-sided canopy (S)	1	2	Remove
51288	9	8	Douglas-fir (<i>Pseudotsuga menziesii</i>)		1	1	Remove
51290	13	13	Douglas-fir (<i>Pseudotsuga menziesii</i>)		1	1	Remove
51295	10	10	Douglas-fir (<i>Pseudotsuga menziesii</i>)		1	1	Remove
51296	10	7	Douglas-fir (<i>Pseudotsuga menziesii</i>)		1	1	Remove
51299	24	14	Douglas-fir (<i>Pseudotsuga menziesii</i>)	1-sided canopy (W); Bore holes	2	2	Remove
51300	44,18	19	Douglas-fir (<i>Pseudotsuga menziesii</i>)	Codominant base; Sweep	1	2	Remove
51301	8	6	Douglas-fir (<i>Pseudotsuga menziesii</i>)		1	1	Remove
51305	8	8	Douglas-fir (<i>Pseudotsuga menziesii</i>)		1	1	Remove
51306	7	6	Douglas-fir (<i>Pseudotsuga menziesii</i>)	Broken top; Sparse canopy	2	3	Remove
51308	9	8	Douglas-fir (<i>Pseudotsuga menziesii</i>)	Epicormic sprouts	2	1	Remove
51310	8	7	Douglas-fir (<i>Pseudotsuga menziesii</i>)		1	1	Remove
51311	15	8	Douglas-fir (<i>Pseudotsuga menziesii</i>)	Epicormic sprouts	2	1	Remove
51312	11	10	Douglas-fir (<i>Pseudotsuga menziesii</i>)		1	1	Remove
51314	9	7	Douglas-fir (<i>Pseudotsuga menziesii</i>)		1	1	Remove
51316	12	12	Douglas-fir (<i>Pseudotsuga menziesii</i>)		1	1	Remove
51320	9	8	Douglas-fir (<i>Pseudotsuga menziesii</i>)	Broken top; Sparse canopy	2	3	Remove
51321	9	7	Douglas-fir (<i>Pseudotsuga menziesii</i>)		1	1	Remove
51322	10	10	Douglas-fir (<i>Pseudotsuga menziesii</i>)		1	1	Remove
51325	9	4	Douglas-fir (<i>Pseudotsuga menziesii</i>)	High canopy	1	2	Remove
51326	8,6	0	Douglas-fir (<i>Pseudotsuga menziesii</i>)	Dead; Broken at 30'	3	3	Remove
51327	8	7	Douglas-fir (<i>Pseudotsuga menziesii</i>)	Broken top; Sparse canopy	2	3	Remove
51328	8	4	Douglas-fir (<i>Pseudotsuga menziesii</i>)	High canopy	1	2	Remove
51333	8	8	Douglas-fir (<i>Pseudotsuga menziesii</i>)		1	1	Remove
51335	8	0	Douglas-fir (<i>Pseudotsuga menziesii</i>)	Dead; Broken at 30'	3	3	Remove
51336	9	10	Douglas-fir (<i>Pseudotsuga menziesii</i>)		1	1	Remove
51339	10	10	Douglas-fir (<i>Pseudotsuga menziesii</i>)		1	1	Remove
51340	8	5	Douglas-fir (<i>Pseudotsuga menziesii</i>)	Broken top; Sparse canopy	2	3	Remove
51341	9	6	Douglas-fir (<i>Pseudotsuga menziesii</i>)	Sparse canopy; High canopy	2	2	Remove
51343	9	8	Douglas-fir (<i>Pseudotsuga menziesii</i>)		1	1	Remove
51344	8	7	Douglas-fir (<i>Pseudotsuga menziesii</i>)	Broken top; Sparse canopy; 1-sided canopy (W)	2	3	Remove

Detailed Tree Inventory for Autumn Sunrise

AKS Job No. 7454 - Evaluation Date: 2/1/2021 - 4/12/2021 - Evaluated by: BRK

Tree #	DBH (in.)	Avg. Crown Radius (ft)	Tree Species Common Name (Scientific name)	Comments	Health Rating*	Structure Rating**	Remove/Preserve
51345	10	13	Douglas-fir (<i>Pseudotsuga menziesii</i>)	Broken top; Sparse canopy	2	3	Remove
51348	11	11	Douglas-fir (<i>Pseudotsuga menziesii</i>)		1	1	Remove
51349	10	10	Douglas-fir (<i>Pseudotsuga menziesii</i>)		1	1	Remove
51353	9	7	Douglas-fir (<i>Pseudotsuga menziesii</i>)		1	1	Remove
51356	9	10	Douglas-fir (<i>Pseudotsuga menziesii</i>)	Broken top; Sparse canopy; 1-sided canopy (W)	2	3	Remove
51358	8	5	Douglas-fir (<i>Pseudotsuga menziesii</i>)		1	1	Remove
51359	8	7	Douglas-fir (<i>Pseudotsuga menziesii</i>)		1	1	Remove
51363	28	23	Douglas-fir (<i>Pseudotsuga menziesii</i>)	Dead branches; Sparse canopy	2	2	Remove
51366	8	10	Douglas-fir (<i>Pseudotsuga menziesii</i>)		1	1	Remove
51367	10	12	Douglas-fir (<i>Pseudotsuga menziesii</i>)		1	1	Remove
51370	11	10	Douglas-fir (<i>Pseudotsuga menziesii</i>)		1	1	Remove
51371	11	13	Douglas-fir (<i>Pseudotsuga menziesii</i>)		1	1	Remove
51372	13	13	Douglas-fir (<i>Pseudotsuga menziesii</i>)		1	1	Remove
51375	10	10	Douglas-fir (<i>Pseudotsuga menziesii</i>)		1	1	Remove
51376	12	13	Douglas-fir (<i>Pseudotsuga menziesii</i>)		1	1	Remove
51379	10	10	Douglas-fir (<i>Pseudotsuga menziesii</i>)		1	1	Remove
51380	11	11	Douglas-fir (<i>Pseudotsuga menziesii</i>)	1-sided canopy (W)	1	2	Remove
51383	8	9	Douglas-fir (<i>Pseudotsuga menziesii</i>)	Broken top; Sparse canopy	2	3	Remove
51384	12	9	Douglas-fir (<i>Pseudotsuga menziesii</i>)		1	1	Remove
51386	9	10	Douglas-fir (<i>Pseudotsuga menziesii</i>)		1	1	Remove
51387	10	11	Douglas-fir (<i>Pseudotsuga menziesii</i>)	1-sided canopy (W)	1	2	Remove
51389	7,6	12	Cherry (<i>Prunus sp.</i>)	1-sided canopy (W)	1	2	Remove
51392	6,6,7	11	Willow (<i>Salix sp.</i>)	Small cavities with decay	2	2	Remove
51398	20	15	Douglas-fir (<i>Pseudotsuga menziesii</i>)	OFFSITE; Evaluated behind fence; Recent trenching within 5' of tree	2	2	Preserve
51448	9	12	Douglas-fir (<i>Pseudotsuga menziesii</i>)	1-sided canopy (W)	1	2	Remove
51449	9	11	Douglas-fir (<i>Pseudotsuga menziesii</i>)	Broken top; 1-sided canopy (W)	2	3	Remove
51451	35	22	Douglas-fir (<i>Pseudotsuga menziesii</i>)		1	1	Remove
51453	9	7	Douglas-fir (<i>Pseudotsuga menziesii</i>)		1	1	Remove
51454	9	8	Douglas-fir (<i>Pseudotsuga menziesii</i>)		1	1	Remove
51455	10	6	Douglas-fir (<i>Pseudotsuga menziesii</i>)		1	1	Remove
51456	12	11	Douglas-fir (<i>Pseudotsuga menziesii</i>)	1-sided canopy (S)	1	2	Remove
51457	11	7	Douglas-fir (<i>Pseudotsuga menziesii</i>)		1	1	Remove
51460	11	13	Douglas-fir (<i>Pseudotsuga menziesii</i>)	1-sided canopy (S)	1	2	Remove
51461	13	10	Douglas-fir (<i>Pseudotsuga menziesii</i>)		1	1	Remove
51462	10	8	Douglas-fir (<i>Pseudotsuga menziesii</i>)		1	1	Remove
51463	11	10	Douglas-fir (<i>Pseudotsuga menziesii</i>)	Broken top; Sparse canopy	2	3	Remove
51464	10	9	Douglas-fir (<i>Pseudotsuga menziesii</i>)		1	1	Remove
51465	14	13	Douglas-fir (<i>Pseudotsuga menziesii</i>)		1	1	Remove
51466	11	12	Douglas-fir (<i>Pseudotsuga menziesii</i>)		1	1	Remove
51467	10	11	Douglas-fir (<i>Pseudotsuga menziesii</i>)		1	1	Remove
51468	13	15	Douglas-fir (<i>Pseudotsuga menziesii</i>)		1	1	Remove
51469	8	8	Douglas-fir (<i>Pseudotsuga menziesii</i>)		1	1	Remove
51470	9	7	Douglas-fir (<i>Pseudotsuga menziesii</i>)		1	1	Remove
51471	12	9	Douglas-fir (<i>Pseudotsuga menziesii</i>)		1	1	Remove
51472	12	9	Douglas-fir (<i>Pseudotsuga menziesii</i>)		1	1	Remove
51473	8	7	Douglas-fir (<i>Pseudotsuga menziesii</i>)		1	1	Remove
51474	11	10	Douglas-fir (<i>Pseudotsuga menziesii</i>)		1	1	Remove
51475	11	7	Douglas-fir (<i>Pseudotsuga menziesii</i>)		1	1	Remove
51476	9	8	Douglas-fir (<i>Pseudotsuga menziesii</i>)	Broken top; Sparse canopy	2	3	Remove
51477	11	8	Douglas-fir (<i>Pseudotsuga menziesii</i>)		1	1	Remove
51478	10	6	Douglas-fir (<i>Pseudotsuga menziesii</i>)		1	1	Remove
51479	12	7	Douglas-fir (<i>Pseudotsuga menziesii</i>)		1	1	Remove
51480	10	10	Douglas-fir (<i>Pseudotsuga menziesii</i>)		1	1	Remove
51482	6,6	9	English Hawthorn (<i>Crataegus monogyna</i>)		1	1	Remove
51483	10	8	Douglas-fir (<i>Pseudotsuga menziesii</i>)		1	1	Remove
51484	8	10	Douglas-fir (<i>Pseudotsuga menziesii</i>)	1-sided canopy (N)	1	2	Remove
51485	11	8	Douglas-fir (<i>Pseudotsuga menziesii</i>)		1	1	Remove
51486	13	13	Douglas-fir (<i>Pseudotsuga menziesii</i>)		1	1	Remove
51487	12	10	Douglas-fir (<i>Pseudotsuga menziesii</i>)		1	1	Remove
51490	9	9	Douglas-fir (<i>Pseudotsuga menziesii</i>)		1	1	Remove
51491	9	18	Willow (<i>Salix sp.</i>)	Lean (S); Dead branches	2	2	Remove
51492	26	16	Douglas-fir (<i>Pseudotsuga menziesii</i>)		1	1	Remove
51493	14	13	Douglas-fir (<i>Pseudotsuga menziesii</i>)		1	1	Remove
51494	13	12	Douglas-fir (<i>Pseudotsuga menziesii</i>)	1-sided canopy (W)	1	2	Remove
51496	8	6	Douglas-fir (<i>Pseudotsuga menziesii</i>)		1	1	Remove
51498	10	9	Douglas-fir (<i>Pseudotsuga menziesii</i>)		1	1	Remove
51499	12	11	Douglas-fir (<i>Pseudotsuga menziesii</i>)		1	1	Remove
51500	9	9	Douglas-fir (<i>Pseudotsuga menziesii</i>)		1	1	Remove

Detailed Tree Inventory for Autumn Sunrise

AKS Job No. 7454 - Evaluation Date: 2/1/2021 - 4/12/2021 - Evaluated by: BRK

Tree #	DBH (in.)	Avg. Crown Radius (ft)	Tree Species Common Name (<i>Scientific name</i>)	Comments	Health Rating*	Structure Rating**	Remove/Preserve
51501	12	10	Douglas-fir (<i>Pseudotsuga menziesii</i>)		1	1	Remove
51502	8	9	Douglas-fir (<i>Pseudotsuga menziesii</i>)		1	1	Remove
51503	10	8	Douglas-fir (<i>Pseudotsuga menziesii</i>)		1	1	Remove
51504	8	6	Douglas-fir (<i>Pseudotsuga menziesii</i>)		1	1	Remove
51505	9	8	Douglas-fir (<i>Pseudotsuga menziesii</i>)		1	1	Remove
51506	8	6	Douglas-fir (<i>Pseudotsuga menziesii</i>)		1	1	Remove
51507	20	17	Douglas-fir (<i>Pseudotsuga menziesii</i>)		1	1	Remove
51508	9	9	Douglas-fir (<i>Pseudotsuga menziesii</i>)	Broken top; Sparse canopy	2	3	Remove
51509	9	4	Douglas-fir (<i>Pseudotsuga menziesii</i>)	Broken top; Sparse canopy	2	3	Remove
51510	8	0	Douglas-fir (<i>Pseudotsuga menziesii</i>)	Dead; Broken at 40'	3	3	Remove
51511	10	11	Douglas-fir (<i>Pseudotsuga menziesii</i>)		1	1	Remove
51512	9	10	Douglas-fir (<i>Pseudotsuga menziesii</i>)		1	1	Remove
51513	9	8	Douglas-fir (<i>Pseudotsuga menziesii</i>)		1	1	Remove
51514	12	10	Douglas-fir (<i>Pseudotsuga menziesii</i>)		1	1	Remove
51515	10	11	Douglas-fir (<i>Pseudotsuga menziesii</i>)		1	1	Remove
51516	8	7	Douglas-fir (<i>Pseudotsuga menziesii</i>)		1	1	Remove
51517	10	9	Douglas-fir (<i>Pseudotsuga menziesii</i>)		1	1	Remove
51518	9	6	Douglas-fir (<i>Pseudotsuga menziesii</i>)		1	1	Remove
51519	9	0	Douglas-fir (<i>Pseudotsuga menziesii</i>)	Dead; Broken at 20'	3	3	Remove
51520	17	14	Douglas-fir (<i>Pseudotsuga menziesii</i>)		1	1	Remove
51521	18	14	Douglas-fir (<i>Pseudotsuga menziesii</i>)		1	1	Remove
51524	10	6	Douglas-fir (<i>Pseudotsuga menziesii</i>)		1	1	Remove
51525	9	8	Douglas-fir (<i>Pseudotsuga menziesii</i>)		1	1	Remove
51526	8	5	Douglas-fir (<i>Pseudotsuga menziesii</i>)	Broken top; Sparse canopy	2	3	Remove
51527	8	0	Douglas-fir (<i>Pseudotsuga menziesii</i>)	Dead ; Broken at 40'	3	3	Remove
51528	10	10	Douglas-fir (<i>Pseudotsuga menziesii</i>)	Broken at very top	2	2	Remove
51529	9	6	Douglas-fir (<i>Pseudotsuga menziesii</i>)	High canopy	1	2	Remove
51530	9	7	Douglas-fir (<i>Pseudotsuga menziesii</i>)	Broken at very top	2	2	Remove
51531	10	6	Douglas-fir (<i>Pseudotsuga menziesii</i>)		1	1	Remove
51532	12	11	Douglas-fir (<i>Pseudotsuga menziesii</i>)		1	1	Remove
51533	8	5	Douglas-fir (<i>Pseudotsuga menziesii</i>)	High canopy	1	2	Remove
51534	11	11	Douglas-fir (<i>Pseudotsuga menziesii</i>)		1	1	Remove
51535	9	10	Douglas-fir (<i>Pseudotsuga menziesii</i>)	Sparse canopy	2	2	Remove
51537	10	6	Douglas-fir (<i>Pseudotsuga menziesii</i>)		1	1	Remove
51538	8	0	Douglas-fir (<i>Pseudotsuga menziesii</i>)	Dead; Broken at 40'	3	3	Remove
51539	8	0	Douglas-fir (<i>Pseudotsuga menziesii</i>)	Dead; Broken at 40'	3	3	Remove
51544	8	0	Douglas-fir (<i>Pseudotsuga menziesii</i>)	Dead	3	3	Remove
51545	8	10	Douglas-fir (<i>Pseudotsuga menziesii</i>)		1	1	Remove
51547	7	0	Cherry (<i>Prunus sp.</i>)	Dead; Broken at 30'	3	3	Remove
51548	8	0	Douglas-fir (<i>Pseudotsuga menziesii</i>)	Dead; Broken at 40'	3	3	Remove
51549	9,10	0	Cherry (<i>Prunus sp.</i>)	Dead; Broken at 30'	3	3	Remove
51550	9	7	Cherry (<i>Prunus sp.</i>)		1	1	Remove
51551	9	3	Douglas-fir (<i>Pseudotsuga menziesii</i>)	High canopy	1	2	Remove
51553	39	20	Douglas-fir (<i>Pseudotsuga menziesii</i>)		1	1	Remove
51555	8	8	Douglas-fir (<i>Pseudotsuga menziesii</i>)		1	1	Remove
51557	9	11	Douglas-fir (<i>Pseudotsuga menziesii</i>)		1	1	Remove
51564	33	17	Douglas-fir (<i>Pseudotsuga menziesii</i>)		1	1	Remove
51565	14	16	Douglas-fir (<i>Pseudotsuga menziesii</i>)	1-sided canopy (NW)	1	2	Remove
51566	15	16	Douglas-fir (<i>Pseudotsuga menziesii</i>)	Crooked bole	1	2	Remove
51567	11	11	Douglas-fir (<i>Pseudotsuga menziesii</i>)		1	1	Remove
51568	12,8,8	17	Pacific Madrone (<i>Arbutus menziesii</i>)	1-sided canopy (W)	1	2	Remove
51569	12	11	Douglas-fir (<i>Pseudotsuga menziesii</i>)		1	1	Remove
51571	12	10	Douglas-fir (<i>Pseudotsuga menziesii</i>)		1	1	Remove
51573	13	12	Douglas-fir (<i>Pseudotsuga menziesii</i>)		1	1	Remove
51575	12	9	Douglas-fir (<i>Pseudotsuga menziesii</i>)		1	1	Remove
51576	13	13	Douglas-fir (<i>Pseudotsuga menziesii</i>)		1	1	Remove
51577	11	10	Douglas-fir (<i>Pseudotsuga menziesii</i>)		1	1	Remove
51578	11	11	Douglas-fir (<i>Pseudotsuga menziesii</i>)		1	1	Remove
51580	8	7	Douglas-fir (<i>Pseudotsuga menziesii</i>)		1	1	Remove
51582	8	10	Douglas-fir (<i>Pseudotsuga menziesii</i>)	Crooked bole	1	2	Remove
51585	8	11	Douglas-fir (<i>Pseudotsuga menziesii</i>)		1	1	Remove
51586	11	10	Douglas-fir (<i>Pseudotsuga menziesii</i>)		1	1	Remove
51588	13	12	Douglas-fir (<i>Pseudotsuga menziesii</i>)		1	1	Remove
51589	14	15	Douglas-fir (<i>Pseudotsuga menziesii</i>)		1	1	Remove
51590	10	12	Douglas-fir (<i>Pseudotsuga menziesii</i>)	1-sided canopy (W)	1	2	Remove
51608	9	9	Douglas-fir (<i>Pseudotsuga menziesii</i>)		1	1	Remove
51609	11	11	Douglas-fir (<i>Pseudotsuga menziesii</i>)		1	1	Remove
51612	9	0	Douglas-fir (<i>Pseudotsuga menziesii</i>)	Dead; broken at 40'	3	3	Remove
51613	12	9	Douglas-fir (<i>Pseudotsuga menziesii</i>)		1	1	Remove

Detailed Tree Inventory for Autumn Sunrise

AKS Job No. 7454 - Evaluation Date: 2/1/2021 - 4/12/2021 - Evaluated by: BRK

Tree #	DBH (in.)	Avg. Crown Radius (ft)	Tree Species Common Name (<i>Scientific name</i>)	Comments	Health Rating*	Structure Rating**	Remove/Preserve
51615	10	0	Douglas-fir (<i>Pseudotsuga menziesii</i>)	Dead; broken at 40'	3	3	Remove
51616	12	8	Douglas-fir (<i>Pseudotsuga menziesii</i>)		1	1	Remove
51619	9	7	Douglas-fir (<i>Pseudotsuga menziesii</i>)		1	1	Remove
51620	9,6	6	Willow (<i>Salix sp.</i>)	Broken tops; Broken limbs	2	2	Remove
51621	8	0	Douglas-fir (<i>Pseudotsuga menziesii</i>)	Dead; Broken at 40'	3	3	Remove
51623	10	9	Douglas-fir (<i>Pseudotsuga menziesii</i>)	Broken top; Sparse canopy	2	3	Remove
51634	10	10	Douglas-fir (<i>Pseudotsuga menziesii</i>)		1	1	Remove
51635	8	8	Douglas-fir (<i>Pseudotsuga menziesii</i>)	Broken top; Sparse canopy	2	3	Remove
51640	9	9	Douglas-fir (<i>Pseudotsuga menziesii</i>)		1	1	Remove
51644	10	9	Douglas-fir (<i>Pseudotsuga menziesii</i>)		1	1	Remove
51645	9	6	Douglas-fir (<i>Pseudotsuga menziesii</i>)		1	1	Remove
51647	9	8	Douglas-fir (<i>Pseudotsuga menziesii</i>)		1	1	Remove
51649	9	0	Douglas-fir (<i>Pseudotsuga menziesii</i>)	Dead; Broken at 40'	3	3	Remove
51650	10	8	Douglas-fir (<i>Pseudotsuga menziesii</i>)		1	1	Remove
51651	9	7	Douglas-fir (<i>Pseudotsuga menziesii</i>)		1	1	Remove
51652	9	4	Douglas-fir (<i>Pseudotsuga menziesii</i>)	High canopy	1	2	Remove
51653	10	10	Douglas-fir (<i>Pseudotsuga menziesii</i>)		1	1	Remove
51654	8	6	Douglas-fir (<i>Pseudotsuga menziesii</i>)		1	1	Remove
51655	11	12	Douglas-fir (<i>Pseudotsuga menziesii</i>)		1	1	Remove
51657	46	24	Douglas-fir (<i>Pseudotsuga menziesii</i>)		1	1	Remove
51658	10	5	Douglas-fir (<i>Pseudotsuga menziesii</i>)	1-sided canopy (S); Sparse canopy; Epicormic sprouts	2	2	Remove
51661	10	10	Douglas-fir (<i>Pseudotsuga menziesii</i>)		1	1	Remove
51665	8	6	Douglas-fir (<i>Pseudotsuga menziesii</i>)	Broken top	2	3	Remove
51666	13	15	Douglas-fir (<i>Pseudotsuga menziesii</i>)	1-sided canopy (SW)	1	2	Remove
51670	9	0	Douglas-fir (<i>Pseudotsuga menziesii</i>)	Dead; Broken at 30'	3	3	Remove
51671	26	20	Douglas-fir (<i>Pseudotsuga menziesii</i>)		1	1	Remove
51672	9	0	Douglas-fir (<i>Pseudotsuga menziesii</i>)	Dead; Broken at 30'	3	3	Remove
51673	9	10	Douglas-fir (<i>Pseudotsuga menziesii</i>)		1	1	Remove
51677	10	6	Douglas-fir (<i>Pseudotsuga menziesii</i>)	High canopy	1	2	Remove
51678	10	10	Douglas-fir (<i>Pseudotsuga menziesii</i>)		1	1	Remove
51680	12	16	Douglas-fir (<i>Pseudotsuga menziesii</i>)	1-sided canopy (E)	1	2	Remove
51684	8	11	Douglas-fir (<i>Pseudotsuga menziesii</i>)		1	1	Remove
51685	10	6	Douglas-fir (<i>Pseudotsuga menziesii</i>)		1	1	Remove
51686	9	0	Douglas-fir (<i>Pseudotsuga menziesii</i>)	Dead; Broken at 20'	3	3	Remove
51687	11	6	Douglas-fir (<i>Pseudotsuga menziesii</i>)		1	1	Remove
51690	9	0	Willow (<i>Salix sp.</i>)	Dead; Lean (E)	3	3	Remove
51691	8	4	Douglas-fir (<i>Pseudotsuga menziesii</i>)	High canopy	1	2	Remove
51693	10	7	Douglas-fir (<i>Pseudotsuga menziesii</i>)	Broken top; Dead foliage	2	3	Remove
51699	14	14	Douglas-fir (<i>Pseudotsuga menziesii</i>)	1-sided canopy (E)	1	2	Remove
51700	18	15	Douglas-fir (<i>Pseudotsuga menziesii</i>)	1-sided canopy (NW)	1	2	Remove
51702	25	17	Douglas-fir (<i>Pseudotsuga menziesii</i>)		1	1	Remove
51705	9	10	Douglas-fir (<i>Pseudotsuga menziesii</i>)		1	1	Remove
51706	9	5	Douglas-fir (<i>Pseudotsuga menziesii</i>)	High canopy	1	2	Remove
51707	10	4	Douglas-fir (<i>Pseudotsuga menziesii</i>)	High canopy	1	2	Remove
51709	27	15	Douglas-fir (<i>Pseudotsuga menziesii</i>)	LINE TREE	1	1	Remove
51710	24	17	Douglas-fir (<i>Pseudotsuga menziesii</i>)	LINE TREE ; Sweep	1	2	Remove
51713	10	9	Douglas-fir (<i>Pseudotsuga menziesii</i>)	1-sided canopy (W)	1	2	Remove
51714	8	7	Douglas-fir (<i>Pseudotsuga menziesii</i>)	Broken top; 1-sided canopy (S)	2	3	Remove
51717	28	16	Douglas-fir (<i>Pseudotsuga menziesii</i>)	LINE TREE	1	1	Remove
51719	34	20	Douglas-fir (<i>Pseudotsuga menziesii</i>)		1	1	Remove
51722	10	6	Douglas-fir (<i>Pseudotsuga menziesii</i>)	Broken top; Sparse canopy	2	3	Remove
51725	9	6	Douglas-fir (<i>Pseudotsuga menziesii</i>)	Broken top; Sparse canopy	2	3	Remove
51726	9	7	Douglas-fir (<i>Pseudotsuga menziesii</i>)	Broken top; Sparse canopy	2	3	Remove
51728	9	8	Douglas-fir (<i>Pseudotsuga menziesii</i>)	Broken top; Sparse canopy	2	3	Remove
51732	9	5	Douglas-fir (<i>Pseudotsuga menziesii</i>)	High canopy	1	2	Remove
51733	10	6	Douglas-fir (<i>Pseudotsuga menziesii</i>)	High canopy	1	2	Remove
51735	9	3	Douglas-fir (<i>Pseudotsuga menziesii</i>)	High canopy	1	2	Remove
51736	8	5	Douglas-fir (<i>Pseudotsuga menziesii</i>)		1	1	Remove
51740	14	14	Douglas-fir (<i>Pseudotsuga menziesii</i>)	Broken top; Sparse canopy	2	3	Remove
51741	12	0	European White Birch (<i>Betula pendula</i>)	Dead; Broken at 30'	3	3	Remove
51744	11	13	Douglas-fir (<i>Pseudotsuga menziesii</i>)		1	1	Remove
51746	10	16	Pacific Yew (<i>Taxus brevifolia</i>)	1-sided canopy (E); Dead limbs	2	2	Remove
51753	9	0	Douglas-fir (<i>Pseudotsuga menziesii</i>)	Dead; Broken at 20'	3	3	Remove
51762	19	17	Douglas-fir (<i>Pseudotsuga menziesii</i>)	OFFSITE ; Evaluated behind fence	1	1	Remove
51766	47	25	Douglas-fir (<i>Pseudotsuga menziesii</i>)		1	1	Remove
51771	9	6	Douglas-fir (<i>Pseudotsuga menziesii</i>)	Broken top; Sparse canopy	2	3	Remove
51774	22	20	Douglas-fir (<i>Pseudotsuga menziesii</i>)	Crooked; 1-sided canopy (S)	1	2	Remove
51779	23	17	Douglas-fir (<i>Pseudotsuga menziesii</i>)	LINE TREE	1	1	Remove
51786	11	9	Douglas-fir (<i>Pseudotsuga menziesii</i>)		1	1	Remove

Detailed Tree Inventory for Autumn Sunrise

AKS Job No. 7454 - Evaluation Date: 2/1/2021 - 4/12/2021 - Evaluated by: BRK

Tree #	DBH (in.)	Avg. Crown Radius (ft)	Tree Species Common Name (<i>Scientific name</i>)	Comments	Health Rating*	Structure Rating**	Remove/Preserve
51787	16	16	Douglas-fir (<i>Pseudotsuga menziesii</i>)		1	1	Remove
51789	8	0	Douglas-fir (<i>Pseudotsuga menziesii</i>)	Dead	3	3	Remove
51791	10	7	Douglas-fir (<i>Pseudotsuga menziesii</i>)		1	1	Remove
51794	10	8	Douglas-fir (<i>Pseudotsuga menziesii</i>)		1	1	Remove
51796	9	8	Douglas-fir (<i>Pseudotsuga menziesii</i>)		1	1	Remove
51797	11	11	Douglas-fir (<i>Pseudotsuga menziesii</i>)		1	1	Remove
51800	9	11	Douglas-fir (<i>Pseudotsuga menziesii</i>)		1	1	Remove
51801	9	9	Douglas-fir (<i>Pseudotsuga menziesii</i>)		1	1	Remove
51802	9	8	Douglas-fir (<i>Pseudotsuga menziesii</i>)		1	1	Remove
51804	10	6	Douglas-fir (<i>Pseudotsuga menziesii</i>)		1	1	Remove
51805	9	7	Douglas-fir (<i>Pseudotsuga menziesii</i>)	Codominant top	1	2	Remove
51813	8	9	Douglas-fir (<i>Pseudotsuga menziesii</i>)		1	1	Remove
51817	9	10	Douglas-fir (<i>Pseudotsuga menziesii</i>)		1	1	Remove
51819	11	8	Douglas-fir (<i>Pseudotsuga menziesii</i>)		1	1	Remove
51822	8	4	Douglas-fir (<i>Pseudotsuga menziesii</i>)	High canopy	1	2	Remove
51825	9	10	Douglas-fir (<i>Pseudotsuga menziesii</i>)		1	1	Remove
51826	10	10	Douglas-fir (<i>Pseudotsuga menziesii</i>)		1	1	Remove
51827	8	10	Douglas-fir (<i>Pseudotsuga menziesii</i>)	Lean (W); High canopy	1	2	Remove
51828	8	5	Douglas-fir (<i>Pseudotsuga menziesii</i>)	Broken top; Lean (W)	2	3	Remove
51829	9	5	Douglas-fir (<i>Pseudotsuga menziesii</i>)	Broken top; Sparse canopy	2	3	Remove
51831	9	5	Douglas-fir (<i>Pseudotsuga menziesii</i>)	High canopy	1	2	Remove
51832	10	6	Douglas-fir (<i>Pseudotsuga menziesii</i>)		1	1	Remove
51839	25	25	Douglas-fir (<i>Pseudotsuga menziesii</i>)		1	1	Remove
51840	9	5	Douglas-fir (<i>Pseudotsuga menziesii</i>)	High canopy	1	2	Remove
51841	10	0	Douglas-fir (<i>Pseudotsuga menziesii</i>)	Dead; Broken at 40'	3	3	Remove
51845	12	10	Pacific Yew (<i>Taxus brevifolia</i>)	Suppressed	2	2	Remove
51846	29	20	Douglas-fir (<i>Pseudotsuga menziesii</i>)	Cavity in base with decay	2	2	Remove
51848	8	9	Douglas-fir (<i>Pseudotsuga menziesii</i>)	High canopy	1	2	Remove
51850	8	0	Douglas-fir (<i>Pseudotsuga menziesii</i>)	Dead	3	3	Remove
51855	24	20	Douglas-fir (<i>Pseudotsuga menziesii</i>)		1	1	Remove
51857	9	7	Douglas-fir (<i>Pseudotsuga menziesii</i>)		1	1	Remove
51859	8	9	Douglas-fir (<i>Pseudotsuga menziesii</i>)		1	1	Remove
51863	8	0	Douglas-fir (<i>Pseudotsuga menziesii</i>)	Dead	3	3	Remove
51864	8	6	Douglas-fir (<i>Pseudotsuga menziesii</i>)	High canopy	1	2	Remove
51865	8	8	Douglas-fir (<i>Pseudotsuga menziesii</i>)	High canopy	1	2	Remove
51867	9	7	Douglas-fir (<i>Pseudotsuga menziesii</i>)		1	1	Remove
51868	10	6	Douglas-fir (<i>Pseudotsuga menziesii</i>)	High canopy	1	2	Remove
51872	24	21	Douglas-fir (<i>Pseudotsuga menziesii</i>)	Broken branches	1	1	Remove
51876	8	9	Douglas-fir (<i>Pseudotsuga menziesii</i>)		1	1	Remove
51880	48	20	Douglas-fir (<i>Pseudotsuga menziesii</i>)		1	1	Remove
51881	18	20	Douglas-fir (<i>Pseudotsuga menziesii</i>)	1-sided canopy (N)	1	2	Remove
51885	8	6	Douglas-fir (<i>Pseudotsuga menziesii</i>)	High canopy; Damaged by failed trees	1	1	Remove
51890	9	7	Douglas-fir (<i>Pseudotsuga menziesii</i>)	Broken top; Sparse canopy	2	3	Remove
51896	10	9	Douglas-fir (<i>Pseudotsuga menziesii</i>)		1	1	Remove
51899	22	19	Douglas-fir (<i>Pseudotsuga menziesii</i>)		1	1	Remove
51902	22	17	Douglas-fir (<i>Pseudotsuga menziesii</i>)		1	1	Remove
51903	17	12	Douglas-fir (<i>Pseudotsuga menziesii</i>)		1	1	Remove
51904	12	7	Douglas-fir (<i>Pseudotsuga menziesii</i>)	Suppressed	2	2	Remove
51905	26	19	Douglas-fir (<i>Pseudotsuga menziesii</i>)	Codominant top; Broken branches	2	2	Remove
51912	11	7	Douglas-fir (<i>Pseudotsuga menziesii</i>)		1	1	Remove
51914	13	9	Douglas-fir (<i>Pseudotsuga menziesii</i>)		1	1	Remove
51916	12	9	Douglas-fir (<i>Pseudotsuga menziesii</i>)		1	1	Remove
51917	10	10	Douglas-fir (<i>Pseudotsuga menziesii</i>)		1	1	Remove
51921	9	7	Douglas-fir (<i>Pseudotsuga menziesii</i>)		1	1	Remove
51922	9	0	Douglas-fir (<i>Pseudotsuga menziesii</i>)	Dead	3	3	Remove
51923	8	6	Douglas-fir (<i>Pseudotsuga menziesii</i>)	High canopy	1	2	Remove
51926	8	10	Douglas-fir (<i>Pseudotsuga menziesii</i>)	1-sided canopy (W)	1	2	Remove
51930	8	11	Douglas-fir (<i>Pseudotsuga menziesii</i>)	1-sided canopy (W)	1	2	Remove
51931	10	9	Douglas-fir (<i>Pseudotsuga menziesii</i>)		1	1	Remove
51935	10	14	Douglas-fir (<i>Pseudotsuga menziesii</i>)	1-sided canopy (NW)	1	2	Remove
51937	9	8	Douglas-fir (<i>Pseudotsuga menziesii</i>)		1	1	Remove
51939	8	6	Douglas-fir (<i>Pseudotsuga menziesii</i>)		1	1	Remove
51943	10	7	Douglas-fir (<i>Pseudotsuga menziesii</i>)		1	1	Remove
51944	8	8	Douglas-fir (<i>Pseudotsuga menziesii</i>)	Top lean (W); High canopy	1	2	Remove
51945	9	0	Douglas-fir (<i>Pseudotsuga menziesii</i>)	Dead; Broken at 30'	3	3	Remove
51948	11	7	Douglas-fir (<i>Pseudotsuga menziesii</i>)		1	1	Remove
51949	11	6	Douglas-fir (<i>Pseudotsuga menziesii</i>)	High canopy; Epicormic sprouts	2	2	Remove
51950	12	10	Douglas-fir (<i>Pseudotsuga menziesii</i>)		1	1	Remove
51951	12	10	Douglas-fir (<i>Pseudotsuga menziesii</i>)	Damaged by failed trees; High canopy	2	2	Remove

Detailed Tree Inventory for Autumn Sunrise

AKS Job No. 7454 - Evaluation Date: 2/1/2021 - 4/12/2021 - Evaluated by: BRK

Tree #	DBH (in.)	Avg. Crown Radius (ft)	Tree Species Common Name (<i>Scientific name</i>)	Comments	Health Rating*	Structure Rating**	Remove/Preserve
51957	13	10	Douglas-fir (<i>Pseudotsuga menziesii</i>)		1	1	Remove
51961	12	9	Willow (<i>Salix sp.</i>)	Broken limbs; Codominant	1	2	Remove
51966	28	16	Douglas-fir (<i>Pseudotsuga menziesii</i>)		1	1	Remove
51968	31	25	Douglas-fir (<i>Pseudotsuga menziesii</i>)	1-sided canopy (W)	1	2	Remove
51969	16	19	Douglas-fir (<i>Pseudotsuga menziesii</i>)	Broken top	2	3	Remove
51973	16	13	Douglas-fir (<i>Pseudotsuga menziesii</i>)		1	1	Remove
51974	13	5	Douglas-fir (<i>Pseudotsuga menziesii</i>)	High canopy	1	2	Remove
51976	9	7	Douglas-fir (<i>Pseudotsuga menziesii</i>)	Mechanical damage; Seepage; Sparse canopy	2	2	Remove
51977	13	11	Douglas-fir (<i>Pseudotsuga menziesii</i>)		1	1	Remove
51978	8	7	Douglas-fir (<i>Pseudotsuga menziesii</i>)		1	1	Remove
51980	12	8	Douglas-fir (<i>Pseudotsuga menziesii</i>)		1	1	Remove
51981	10	9	Douglas-fir (<i>Pseudotsuga menziesii</i>)	1-sided canopy (N)	1	2	Remove
51982	9	10	Douglas-fir (<i>Pseudotsuga menziesii</i>)		1	1	Remove
51983	13	11	Douglas-fir (<i>Pseudotsuga menziesii</i>)		1	1	Remove
51985	9	9	Douglas-fir (<i>Pseudotsuga menziesii</i>)		1	1	Remove
51986	14	10	Douglas-fir (<i>Pseudotsuga menziesii</i>)		1	1	Remove
51988	12	9	Douglas-fir (<i>Pseudotsuga menziesii</i>)		1	1	Remove
51989	10	10	Douglas-fir (<i>Pseudotsuga menziesii</i>)	1-sided canopy (N)	1	2	Remove
51990	11	5	Douglas-fir (<i>Pseudotsuga menziesii</i>)	High canopy	1	2	Remove
51991	9	0	Douglas-fir (<i>Pseudotsuga menziesii</i>)	Dead	3	3	Remove
51994	8	7	Douglas-fir (<i>Pseudotsuga menziesii</i>)	High canopy; Damaged by failed trees	2	2	Remove
51996	8	3	Douglas-fir (<i>Pseudotsuga menziesii</i>)	High canopy; Sparse canopy	2	2	Remove
51998	8	10	Sweet Cherry (<i>Prunus avium</i>)		1	1	Remove
52001	53	26	Douglas-fir (<i>Pseudotsuga menziesii</i>)		1	1	Remove
52002	8	6	Douglas-fir (<i>Pseudotsuga menziesii</i>)	Broken top	2	3	Remove
52003	11	8	Douglas-fir (<i>Pseudotsuga menziesii</i>)		1	1	Remove
52007	11	8	Douglas-fir (<i>Pseudotsuga menziesii</i>)	High canopy	1	2	Remove
52009	10	7	Douglas-fir (<i>Pseudotsuga menziesii</i>)	High canopy; 1-sided canopy (NW)	1	2	Remove
52010	9	8	Douglas-fir (<i>Pseudotsuga menziesii</i>)		1	1	Remove
52012	9	6	Douglas-fir (<i>Pseudotsuga menziesii</i>)		1	1	Remove
52015	9	4	Douglas-fir (<i>Pseudotsuga menziesii</i>)	High canopy	1	2	Remove
52016	9	13	Douglas-fir (<i>Pseudotsuga menziesii</i>)	Very top broken	2	2	Remove
52017	10	7	Douglas-fir (<i>Pseudotsuga menziesii</i>)		1	1	Remove
52019	9	6	Douglas-fir (<i>Pseudotsuga menziesii</i>)		1	1	Remove
52020	11	8	Douglas-fir (<i>Pseudotsuga menziesii</i>)		1	1	Remove
52023	10	7	Douglas-fir (<i>Pseudotsuga menziesii</i>)		1	1	Remove
52024	10	8	Douglas-fir (<i>Pseudotsuga menziesii</i>)		1	1	Remove
52026	10	7	Douglas-fir (<i>Pseudotsuga menziesii</i>)	High canopy	1	2	Remove
52027	10	7	Douglas-fir (<i>Pseudotsuga menziesii</i>)		1	1	Remove
52029	29	21	Oregon White Oak (<i>Quercus garryana</i>)	Codominant with included bark	1	2	Remove
52031	12	13	Douglas-fir (<i>Pseudotsuga menziesii</i>)		1	1	Remove
52042	15	15	Sweet Cherry (<i>Prunus avium</i>)	Butt sweep	1	2	Remove
52043	10	9	Douglas-fir (<i>Pseudotsuga menziesii</i>)		1	1	Remove
52045	8	6	Douglas-fir (<i>Pseudotsuga menziesii</i>)	Broken top; Sparse canopy	2	3	Remove
52047	9	5	Douglas-fir (<i>Pseudotsuga menziesii</i>)	Broken top; Sparse canopy	2	3	Remove
52049	8	4	Douglas-fir (<i>Pseudotsuga menziesii</i>)	High canopy	1	2	Remove
52054	30	15	Douglas-fir (<i>Pseudotsuga menziesii</i>)	Failed Codominant stem; Very long cavity with significant decay	2	3	Remove
52057	13	13	Douglas-fir (<i>Pseudotsuga menziesii</i>)	Damaged by failed trees; 1-sided canopy (W)	2	2	Remove
52058	11	9	Douglas-fir (<i>Pseudotsuga menziesii</i>)	High canopy	1	2	Remove
52062	11	10	Douglas-fir (<i>Pseudotsuga menziesii</i>)	1-sided canopy (S)	1	2	Remove
52063	11	10	Douglas-fir (<i>Pseudotsuga menziesii</i>)		1	1	Remove
52066	10	10	Douglas-fir (<i>Pseudotsuga menziesii</i>)		1	1	Remove
52067	11	10	Douglas-fir (<i>Pseudotsuga menziesii</i>)	Codominant	1	2	Remove
52068	11	11	Douglas-fir (<i>Pseudotsuga menziesii</i>)		1	1	Remove
52069	12	10	Douglas-fir (<i>Pseudotsuga menziesii</i>)	1-sided canopy (S)	1	2	Remove
52073	14	11	Douglas-fir (<i>Pseudotsuga menziesii</i>)		1	1	Remove
52074	14	12	Douglas-fir (<i>Pseudotsuga menziesii</i>)		1	1	Remove
52078	8	8	Douglas-fir (<i>Pseudotsuga menziesii</i>)	1-sided canopy (S)	1	2	Remove
52079	12	9	Douglas-fir (<i>Pseudotsuga menziesii</i>)		1	1	Remove
52081	12	9	Douglas-fir (<i>Pseudotsuga menziesii</i>)		1	1	Remove
52082	9	7	Douglas-fir (<i>Pseudotsuga menziesii</i>)		1	1	Remove
52088	11	10	Douglas-fir (<i>Pseudotsuga menziesii</i>)	1-sided canopy (W)	1	2	Remove
52091	8	8	Douglas-fir (<i>Pseudotsuga menziesii</i>)	Suppressed; Very sparse canopy	3	2	Remove
52092	8	8	Douglas-fir (<i>Pseudotsuga menziesii</i>)	1-sided canopy (W)	1	2	Remove
52093	10	11	Douglas-fir (<i>Pseudotsuga menziesii</i>)	1-sided canopy (W)	1	2	Remove
52096	12	11	Pacific Yew (<i>Taxus brevifolia</i>)	Lean (W); Some dead branches	2	2	Remove
52097	10	12	Sweet Cherry (<i>Prunus avium</i>)		1	1	Remove
52101	8	0	Douglas-fir (<i>Pseudotsuga menziesii</i>)	Dead	3	3	Remove

Detailed Tree Inventory for Autumn Sunrise

AKS Job No. 7454 - Evaluation Date: 2/1/2021 - 4/12/2021 - Evaluated by: BRK

Tree #	DBH (in.)	Avg. Crown Radius (ft)	Tree Species Common Name (Scientific name)	Comments	Health Rating*	Structure Rating**	Remove/Preserve
52102	12	9	Sweet Cherry (<i>Prunus avium</i>)		1	1	Remove
52103	8	11	Douglas-fir (<i>Pseudotsuga menziesii</i>)	Broken top; 1-sided canopy (W)	2	3	Remove
52106	8	6	Douglas-fir (<i>Pseudotsuga menziesii</i>)		1	1	Remove
52109	28	20	Douglas-fir (<i>Pseudotsuga menziesii</i>)		1	1	Remove
52110	30	20	Douglas-fir (<i>Pseudotsuga menziesii</i>)		1	1	Remove
52111	28	20	Douglas-fir (<i>Pseudotsuga menziesii</i>)		1	1	Remove
52113	25	18	Douglas-fir (<i>Pseudotsuga menziesii</i>)		1	1	Remove
52114	30	20	Douglas-fir (<i>Pseudotsuga menziesii</i>)		1	1	Remove
52116	29	20	Douglas-fir (<i>Pseudotsuga menziesii</i>)		1	1	Remove
52122	8	7	Douglas-fir (<i>Pseudotsuga menziesii</i>)		1	1	Remove
52123	8	7	Douglas-fir (<i>Pseudotsuga menziesii</i>)		1	1	Remove
52125	8	6	Douglas-fir (<i>Pseudotsuga menziesii</i>)		1	1	Remove
52127	8	6	Douglas-fir (<i>Pseudotsuga menziesii</i>)		1	1	Remove
52128	10	9	Douglas-fir (<i>Pseudotsuga menziesii</i>)		1	1	Remove
52129	9	9	Douglas-fir (<i>Pseudotsuga menziesii</i>)	1-sided canopy (S)	1	2	Remove
52130	11	10	Douglas-fir (<i>Pseudotsuga menziesii</i>)	1-sided canopy (S)	1	2	Remove
52131	9	9	Douglas-fir (<i>Pseudotsuga menziesii</i>)	Broken top; Sparse canopy	2	3	Remove
52133	15,17,23	26	Bigleaf Maple (<i>Acer macrophyllum</i>)	Failed Codominant stem; Large cavity with decay; Splitting included bark; Broken top	2	3	Remove
52134	24	19	Douglas-fir (<i>Pseudotsuga menziesii</i>)	Crooked bole	1	2	Remove
52137	9	8	Douglas-fir (<i>Pseudotsuga menziesii</i>)	Broken top; 1-sided canopy (S)	2	3	Remove
52141	36	18	Douglas-fir (<i>Pseudotsuga menziesii</i>)		1	1	Remove
52147	9	10	Douglas-fir (<i>Pseudotsuga menziesii</i>)	Broken top; Sparse canopy	2	3	Remove
52150	13	11	Douglas-fir (<i>Pseudotsuga menziesii</i>)		1	1	Remove
52152	30	20	Douglas-fir (<i>Pseudotsuga menziesii</i>)		1	1	Remove
52155	10	7	Douglas-fir (<i>Pseudotsuga menziesii</i>)	High canopy	1	2	Remove
52156	10	7	Douglas-fir (<i>Pseudotsuga menziesii</i>)	Broken top; Sparse canopy	2	3	Remove
52157	8	0	Douglas-fir (<i>Pseudotsuga menziesii</i>)	Dead; Broken at 30'	3	3	Remove
52158	8	6	Douglas-fir (<i>Pseudotsuga menziesii</i>)		1	1	Remove
52159	13	11	Douglas-fir (<i>Pseudotsuga menziesii</i>)	1-sided canopy (N)	1	2	Remove
52161	10	7	Douglas-fir (<i>Pseudotsuga menziesii</i>)		1	1	Remove
52162	9	8	Douglas-fir (<i>Pseudotsuga menziesii</i>)	Broken top	2	3	Remove
52166	8	6	Douglas-fir (<i>Pseudotsuga menziesii</i>)		1	1	Remove
52167	8	10	Douglas-fir (<i>Pseudotsuga menziesii</i>)	Broken top	2	3	Remove
52168	10	8	Douglas-fir (<i>Pseudotsuga menziesii</i>)		1	1	Remove
52169	12	10	Douglas-fir (<i>Pseudotsuga menziesii</i>)		1	1	Remove
52172	10	10	Douglas-fir (<i>Pseudotsuga menziesii</i>)		1	1	Remove
52173	8	7	Douglas-fir (<i>Pseudotsuga menziesii</i>)	Broken top	2	3	Remove
52174	8	0	Douglas-fir (<i>Pseudotsuga menziesii</i>)	Dead; Broken at 30'	3	3	Remove
52175	29	21	Douglas-fir (<i>Pseudotsuga menziesii</i>)	Some broken branches	1	1	Remove
52182	9	5	Douglas-fir (<i>Pseudotsuga menziesii</i>)	High canopy	1	2	Remove
52183	10	7	Douglas-fir (<i>Pseudotsuga menziesii</i>)		1	1	Remove
52185	10	6	Douglas-fir (<i>Pseudotsuga menziesii</i>)	high canopy	1	2	Remove
52186	14	11	Douglas-fir (<i>Pseudotsuga menziesii</i>)	Epicormic sprouts; Some broken branches	2	1	Remove
52193	8	8	Douglas-fir (<i>Pseudotsuga menziesii</i>)		1	1	Remove
52194	10	7	Douglas-fir (<i>Pseudotsuga menziesii</i>)		1	1	Remove
52196	25	19	Douglas-fir (<i>Pseudotsuga menziesii</i>)		1	1	Remove
52200	8,7,7,6	7	Willow (<i>Salix sp.</i>)	Broken tops on all stems	2	3	Remove
52201	8	6	Douglas-fir (<i>Pseudotsuga menziesii</i>)		1	1	Remove
52204	9	7	Douglas-fir (<i>Pseudotsuga menziesii</i>)		1	1	Remove
52205	10	8	Douglas-fir (<i>Pseudotsuga menziesii</i>)		1	1	Remove
52207	9	7	Douglas-fir (<i>Pseudotsuga menziesii</i>)		1	1	Remove
52208	9	6	Douglas-fir (<i>Pseudotsuga menziesii</i>)		1	1	Remove
52211	13	12	Douglas-fir (<i>Pseudotsuga menziesii</i>)	1-sided canopy (E)	1	2	Remove
52213	11	7	Douglas-fir (<i>Pseudotsuga menziesii</i>)		1	1	Remove
52215	9	6	Douglas-fir (<i>Pseudotsuga menziesii</i>)		1	1	Remove
52216	12	7	Douglas-fir (<i>Pseudotsuga menziesii</i>)		1	1	Remove
52218	13	8	Douglas-fir (<i>Pseudotsuga menziesii</i>)		1	1	Remove
52220	8	5	Douglas-fir (<i>Pseudotsuga menziesii</i>)	High canopy	1	2	Remove
52221	13	12	Douglas-fir (<i>Pseudotsuga menziesii</i>)		1	1	Remove
52223	12	9	Douglas-fir (<i>Pseudotsuga menziesii</i>)		1	1	Remove
52224	11	9	Douglas-fir (<i>Pseudotsuga menziesii</i>)		1	1	Remove
52225	8	6	Douglas-fir (<i>Pseudotsuga menziesii</i>)		1	1	Remove
52226	10	9	Douglas-fir (<i>Pseudotsuga menziesii</i>)		1	1	Remove
52228	9	5	Douglas-fir (<i>Pseudotsuga menziesii</i>)	High canopy	1	2	Remove
52229	8	6	Douglas-fir (<i>Pseudotsuga menziesii</i>)	high canopy	1	2	Remove
52230	8	6	Douglas-fir (<i>Pseudotsuga menziesii</i>)		1	1	Remove
52231	12	9	Douglas-fir (<i>Pseudotsuga menziesii</i>)	1-sided canopy (S)	1	2	Remove
52233	10	7	Douglas-fir (<i>Pseudotsuga menziesii</i>)		1	1	Remove

Detailed Tree Inventory for Autumn Sunrise

AKS Job No. 7454 - Evaluation Date: 2/1/2021 - 4/12/2021 - Evaluated by: BRK

Tree #	DBH (in.)	Avg. Crown Radius (ft)	Tree Species Common Name (<i>Scientific name</i>)	Comments	Health Rating*	Structure Rating**	Remove/Preserve
52234	9	6	Douglas-fir (<i>Pseudotsuga menziesii</i>)	1-sided canopy (W)	1	2	Remove
52237	11	9	Douglas-fir (<i>Pseudotsuga menziesii</i>)		1	1	Remove
52238	8	6	Douglas-fir (<i>Pseudotsuga menziesii</i>)		1	1	Remove
52241	8	7	Douglas-fir (<i>Pseudotsuga menziesii</i>)	Broken top; 1-sided canopy (N)	2	3	Remove
52242	8	0	Douglas-fir (<i>Pseudotsuga menziesii</i>)	Dead	3	3	Remove
52244	10	7	Douglas-fir (<i>Pseudotsuga menziesii</i>)		1	1	Remove
52246	9	6	Douglas-fir (<i>Pseudotsuga menziesii</i>)		1	1	Remove
52248	9	9	Douglas-fir (<i>Pseudotsuga menziesii</i>)		1	1	Remove
52251	24	19	Douglas-fir (<i>Pseudotsuga menziesii</i>)		1	1	Remove
52252	18	18	Douglas-fir (<i>Pseudotsuga menziesii</i>)	1-sided canopy (E)	1	2	Remove
52254	11	8	Douglas-fir (<i>Pseudotsuga menziesii</i>)	1-sided canopy (W)	1	2	Remove
52255	10	6	Douglas-fir (<i>Pseudotsuga menziesii</i>)		1	1	Remove
52256	11	8	Douglas-fir (<i>Pseudotsuga menziesii</i>)		1	1	Remove
52258	8	0	Douglas-fir (<i>Pseudotsuga menziesii</i>)	Dead	3	3	Remove
52261	8	6	Douglas-fir (<i>Pseudotsuga menziesii</i>)	High canopy	1	2	Remove
52263	8	5	Douglas-fir (<i>Pseudotsuga menziesii</i>)	high canopy	1	2	Remove
52267	9	12	Douglas-fir (<i>Pseudotsuga menziesii</i>)	1-sided canopy (S)	1	2	Remove
52268	14	10	Douglas-fir (<i>Pseudotsuga menziesii</i>)		1	1	Remove
52269	11	11	Douglas-fir (<i>Pseudotsuga menziesii</i>)		1	1	Remove
52270	8	6	Douglas-fir (<i>Pseudotsuga menziesii</i>)	Broken top; Sparse canopy	2	3	Remove
52273	10	8	Douglas-fir (<i>Pseudotsuga menziesii</i>)		1	1	Remove
52274	10	8	Douglas-fir (<i>Pseudotsuga menziesii</i>)		1	1	Remove
52275	11	8	Douglas-fir (<i>Pseudotsuga menziesii</i>)		1	1	Remove
52276	8	6	Douglas-fir (<i>Pseudotsuga menziesii</i>)	Damage at base with seepage	1	2	Remove
52277	10	11	Douglas-fir (<i>Pseudotsuga menziesii</i>)	1-sided canopy (S)	1	2	Remove
52279	10	6	Douglas-fir (<i>Pseudotsuga menziesii</i>)		1	1	Remove
52281	8	9	Douglas-fir (<i>Pseudotsuga menziesii</i>)		1	1	Remove
52282	10	7	Douglas-fir (<i>Pseudotsuga menziesii</i>)		1	1	Remove
52286	11	9	Douglas-fir (<i>Pseudotsuga menziesii</i>)		1	1	Remove
52287	8	8	Douglas-fir (<i>Pseudotsuga menziesii</i>)		1	1	Remove
52288	12	12	Douglas-fir (<i>Pseudotsuga menziesii</i>)	1-sided canopy (W)	1	2	Remove
52289	8	8	Douglas-fir (<i>Pseudotsuga menziesii</i>)	1-sided canopy (E)	1	2	Remove
52290	9	6	Douglas-fir (<i>Pseudotsuga menziesii</i>)	high canopy	1	2	Remove
52292	8	0	Douglas-fir (<i>Pseudotsuga menziesii</i>)	Dead	3	3	Remove
52293	10	0	Douglas-fir (<i>Pseudotsuga menziesii</i>)	Dead	3	3	Remove
52294	10	8	Douglas-fir (<i>Pseudotsuga menziesii</i>)		1	1	Remove
52297	13	11	Douglas-fir (<i>Pseudotsuga menziesii</i>)	1-sided canopy (SE)	1	2	Remove
52298	12	10	Douglas-fir (<i>Pseudotsuga menziesii</i>)		1	1	Remove
52300	9	8	Douglas-fir (<i>Pseudotsuga menziesii</i>)		1	1	Remove
52302	9	8	Douglas-fir (<i>Pseudotsuga menziesii</i>)		1	1	Remove
52304	11	0	Pacific Yew (<i>Taxus brevifolia</i>)	Dead	3	3	Remove
52306	25	22	Douglas-fir (<i>Pseudotsuga menziesii</i>)		1	1	Remove
52309	9	12	Douglas-fir (<i>Pseudotsuga menziesii</i>)		1	1	Remove
52310	9	8	Douglas-fir (<i>Pseudotsuga menziesii</i>)		1	1	Remove
52312	11	9	Douglas-fir (<i>Pseudotsuga menziesii</i>)		1	1	Remove
52313	14	12	Douglas-fir (<i>Pseudotsuga menziesii</i>)	Sweep	1	2	Remove
52318	29	20	Douglas-fir (<i>Pseudotsuga menziesii</i>)		1	1	Remove
52320	8,22	18	Douglas-fir (<i>Pseudotsuga menziesii</i>)	1-sided canopy (S)	1	2	Remove
52322	10	10	Willow (<i>Salix sp.</i>)	Broken limbs; Codominant with included bark	1	2	Remove
52325	19	16	Douglas-fir (<i>Pseudotsuga menziesii</i>)	Sweep (N)	1	2	Remove
52331	12	7	Douglas-fir (<i>Pseudotsuga menziesii</i>)		1	1	Remove
52333	8	5	Douglas-fir (<i>Pseudotsuga menziesii</i>)	High canopy	1	2	Remove
52335	11	6	Douglas-fir (<i>Pseudotsuga menziesii</i>)		1	1	Remove
52338	13	15	Douglas-fir (<i>Pseudotsuga menziesii</i>)	1-sided canopy (S)	1	2	Remove
52339	12	13	Douglas-fir (<i>Pseudotsuga menziesii</i>)	1-sided canopy (W)	1	2	Remove
52341	14	12	Douglas-fir (<i>Pseudotsuga menziesii</i>)	1-sided canopy (W)	1	2	Remove
52342	11	7	Douglas-fir (<i>Pseudotsuga menziesii</i>)		1	1	Remove
52343	12	12	Douglas-fir (<i>Pseudotsuga menziesii</i>)	1-sided canopy (W)	1	2	Remove
52345	11	10	Douglas-fir (<i>Pseudotsuga menziesii</i>)	1-sided canopy (W)	1	2	Remove
52347	13	17	Douglas-fir (<i>Pseudotsuga menziesii</i>)	1-sided canopy (W)	1	2	Remove
52348	14	17	Douglas-fir (<i>Pseudotsuga menziesii</i>)	1-sided canopy (W)	1	2	Remove
52349	17	17	Douglas-fir (<i>Pseudotsuga menziesii</i>)	1-sided canopy (W)	1	2	Remove
52350	10	9	Douglas-fir (<i>Pseudotsuga menziesii</i>)		1	1	Remove
52352	14	9	Douglas-fir (<i>Pseudotsuga menziesii</i>)		1	1	Remove
52353	12	9	Douglas-fir (<i>Pseudotsuga menziesii</i>)		1	1	Remove
52355	12	6	Douglas-fir (<i>Pseudotsuga menziesii</i>)		1	1	Remove
52356	14	7	Douglas-fir (<i>Pseudotsuga menziesii</i>)	Crooked bole	1	2	Remove
52357	12	7	Douglas-fir (<i>Pseudotsuga menziesii</i>)		1	1	Remove
52358	12	6	Douglas-fir (<i>Pseudotsuga menziesii</i>)		1	1	Remove

Detailed Tree Inventory for Autumn Sunrise

AKS Job No. 7454 - Evaluation Date: 2/1/2021 - 4/12/2021 - Evaluated by: BRK

Tree #	DBH (in.)	Avg. Crown Radius (ft)	Tree Species Common Name (<i>Scientific name</i>)	Comments	Health Rating*	Structure Rating**	Remove/Preserve
52359	10	6	Douglas-fir (<i>Pseudotsuga menziesii</i>)		1	1	Remove
52361	8	4	Douglas-fir (<i>Pseudotsuga menziesii</i>)		1	1	Remove
52362	12,7	6	Douglas-fir (<i>Pseudotsuga menziesii</i>)		1	1	Remove
52363	12	6	Douglas-fir (<i>Pseudotsuga menziesii</i>)		1	1	Remove
52364	10	7	Douglas-fir (<i>Pseudotsuga menziesii</i>)		1	1	Remove
52365	12	7	Douglas-fir (<i>Pseudotsuga menziesii</i>)		1	1	Remove
52366	10	7	Douglas-fir (<i>Pseudotsuga menziesii</i>)		1	1	Remove
52367	13	8	Douglas-fir (<i>Pseudotsuga menziesii</i>)		1	1	Remove
52369	16	9	Douglas-fir (<i>Pseudotsuga menziesii</i>)		1	1	Remove
52370	14	9	Douglas-fir (<i>Pseudotsuga menziesii</i>)		1	1	Remove
52371	16	15	Douglas-fir (<i>Pseudotsuga menziesii</i>)	1-sided canopy (W)	1	2	Remove
52372	10	7	Douglas-fir (<i>Pseudotsuga menziesii</i>)		1	1	Remove
52373	17	15	Douglas-fir (<i>Pseudotsuga menziesii</i>)	1-sided canopy (W)	1	2	Remove
52376	10	8	Douglas-fir (<i>Pseudotsuga menziesii</i>)		1	1	Remove
52377	15	16	Douglas-fir (<i>Pseudotsuga menziesii</i>)	1-sided canopy (W)	1	2	Remove
52378	14	9	Douglas-fir (<i>Pseudotsuga menziesii</i>)	Sparse canopy; Dead branches	2	2	Remove
52379	16	11	Douglas-fir (<i>Pseudotsuga menziesii</i>)		1	1	Remove
52380	15	15	Douglas-fir (<i>Pseudotsuga menziesii</i>)	1-sided canopy (W)	1	2	Remove
52381	10	7	Douglas-fir (<i>Pseudotsuga menziesii</i>)		1	1	Remove
52382	15	16	Douglas-fir (<i>Pseudotsuga menziesii</i>)	1-sided canopy (W)	1	2	Remove
52383	12	6	Douglas-fir (<i>Pseudotsuga menziesii</i>)		1	1	Remove
52385	15	16	Douglas-fir (<i>Pseudotsuga menziesii</i>)	1-sided canopy (W)	1	2	Remove
52386	12	7	Douglas-fir (<i>Pseudotsuga menziesii</i>)		1	1	Remove
52387	21	16	Douglas-fir (<i>Pseudotsuga menziesii</i>)	1-sided canopy (W)	1	2	Remove
52388	9,10	7	Douglas-fir (<i>Pseudotsuga menziesii</i>)	Codominant with included bark	1	2	Remove
52391	8	6	Douglas-fir (<i>Pseudotsuga menziesii</i>)	Codominant with included bark	1	2	Remove
52392	13	7	Douglas-fir (<i>Pseudotsuga menziesii</i>)		1	1	Remove
52393	9	6	Douglas-fir (<i>Pseudotsuga menziesii</i>)	Deformed bole	1	2	Remove
52394	9	6	Douglas-fir (<i>Pseudotsuga menziesii</i>)		1	1	Remove
52395	11	6	Douglas-fir (<i>Pseudotsuga menziesii</i>)		1	1	Remove
52396	11	7	Douglas-fir (<i>Pseudotsuga menziesii</i>)		1	1	Remove
52398	12	10	Douglas-fir (<i>Pseudotsuga menziesii</i>)		1	1	Remove
52399	10	6	Douglas-fir (<i>Pseudotsuga menziesii</i>)		1	1	Remove
52400	10	7	Douglas-fir (<i>Pseudotsuga menziesii</i>)		1	1	Remove
52401	11	9	Douglas-fir (<i>Pseudotsuga menziesii</i>)		1	1	Remove
52403	12	7	Douglas-fir (<i>Pseudotsuga menziesii</i>)		1	1	Remove
52404	10,11	11	Douglas-fir (<i>Pseudotsuga menziesii</i>)	Codominant with included bark	1	2	Remove
52405	12	8	Douglas-fir (<i>Pseudotsuga menziesii</i>)		1	1	Remove
52406	13	10	Douglas-fir (<i>Pseudotsuga menziesii</i>)		1	1	Remove
52407	11	13	Douglas-fir (<i>Pseudotsuga menziesii</i>)		1	1	Remove
52409	12	8	Douglas-fir (<i>Pseudotsuga menziesii</i>)		1	1	Remove
52410	12	7	Douglas-fir (<i>Pseudotsuga menziesii</i>)		1	1	Remove
52411	11	6	Douglas-fir (<i>Pseudotsuga menziesii</i>)		1	1	Remove
52412	12	10	Douglas-fir (<i>Pseudotsuga menziesii</i>)		1	1	Remove
52414	15	10	Douglas-fir (<i>Pseudotsuga menziesii</i>)		1	1	Remove
52415	13	8	Douglas-fir (<i>Pseudotsuga menziesii</i>)		1	1	Remove
52416	9	6	Douglas-fir (<i>Pseudotsuga menziesii</i>)		1	1	Remove
52417	8	5	Douglas-fir (<i>Pseudotsuga menziesii</i>)		1	1	Remove
52419	15	8	Douglas-fir (<i>Pseudotsuga menziesii</i>)		1	1	Remove
52420	17	8	Douglas-fir (<i>Pseudotsuga menziesii</i>)		1	1	Remove
52421	11	7	Douglas-fir (<i>Pseudotsuga menziesii</i>)	Crooked bole	1	2	Remove
52423	13	10	Douglas-fir (<i>Pseudotsuga menziesii</i>)		1	1	Remove
52424	12	6	Douglas-fir (<i>Pseudotsuga menziesii</i>)		1	1	Remove
52425	9	9	Douglas-fir (<i>Pseudotsuga menziesii</i>)		1	1	Remove
52427	10	10	Douglas-fir (<i>Pseudotsuga menziesii</i>)		1	1	Remove
52428	11	15	Douglas-fir (<i>Pseudotsuga menziesii</i>)	Crooked bole; Slight lean (W)	1	2	Remove
52430	10	6	Douglas-fir (<i>Pseudotsuga menziesii</i>)		1	1	Remove
52433	11	7	Douglas-fir (<i>Pseudotsuga menziesii</i>)	Codominant with included bark	1	2	Remove
52434	9	6	Douglas-fir (<i>Pseudotsuga menziesii</i>)		1	1	Remove
52436	11	7	Douglas-fir (<i>Pseudotsuga menziesii</i>)		1	1	Remove
52437	10	7	Douglas-fir (<i>Pseudotsuga menziesii</i>)	High canopy	1	2	Remove
52439	16	9	Douglas-fir (<i>Pseudotsuga menziesii</i>)	Sweep	1	2	Remove
52441	12	10	Douglas-fir (<i>Pseudotsuga menziesii</i>)		1	1	Remove
52443	13	11	Douglas-fir (<i>Pseudotsuga menziesii</i>)		1	1	Remove
52445	10	6	Douglas-fir (<i>Pseudotsuga menziesii</i>)		1	1	Remove
52447	10	4	Douglas-fir (<i>Pseudotsuga menziesii</i>)	High canopy	1	2	Remove
52448	14	7	Douglas-fir (<i>Pseudotsuga menziesii</i>)		1	1	Remove
52449	13	8	Douglas-fir (<i>Pseudotsuga menziesii</i>)		1	1	Remove
52450	11	16	Douglas-fir (<i>Pseudotsuga menziesii</i>)	1-sided canopy (W)	1	2	Remove

Detailed Tree Inventory for Autumn Sunrise

AKS Job No. 7454 - Evaluation Date: 2/1/2021 - 4/12/2021 - Evaluated by: BRK

Tree #	DBH (in.)	Avg. Crown Radius (ft)	Tree Species Common Name (<i>Scientific name</i>)	Comments	Health Rating*	Structure Rating**	Remove/Preserve
52452	14	10	Douglas-fir (<i>Pseudotsuga menziesii</i>)		1	1	Remove
52453	15	17	Douglas-fir (<i>Pseudotsuga menziesii</i>)	1-sided canopy (W)	1	2	Remove
52454	9,9	7	Douglas-fir (<i>Pseudotsuga menziesii</i>)	Codominant base with included bark	1	2	Remove
52456	14	16	Douglas-fir (<i>Pseudotsuga menziesii</i>)		1	1	Remove
52457	13	12	Douglas-fir (<i>Pseudotsuga menziesii</i>)		1	1	Remove
52458	12	9	Douglas-fir (<i>Pseudotsuga menziesii</i>)		1	1	Remove
52459	16	16	Douglas-fir (<i>Pseudotsuga menziesii</i>)		1	1	Remove
52461	10,11	16	Douglas-fir (<i>Pseudotsuga menziesii</i>)	Codominant with included bark	1	2	Remove
52462	10	8	Douglas-fir (<i>Pseudotsuga menziesii</i>)		1	1	Remove
52463	12	10	Douglas-fir (<i>Pseudotsuga menziesii</i>)		1	1	Remove
52464	13	8	Douglas-fir (<i>Pseudotsuga menziesii</i>)		1	1	Remove
52466	13	13	Douglas-fir (<i>Pseudotsuga menziesii</i>)		1	1	Remove
52467	14	12	Douglas-fir (<i>Pseudotsuga menziesii</i>)		1	1	Remove
52469	16	14	Douglas-fir (<i>Pseudotsuga menziesii</i>)		1	1	Remove
52471	13	13	Douglas-fir (<i>Pseudotsuga menziesii</i>)		1	1	Remove
52472	14	12	Douglas-fir (<i>Pseudotsuga menziesii</i>)		1	1	Remove
52473	13	11	Douglas-fir (<i>Pseudotsuga menziesii</i>)		1	1	Remove
52474	14	13	Douglas-fir (<i>Pseudotsuga menziesii</i>)		1	1	Remove
52476	12	10	Douglas-fir (<i>Pseudotsuga menziesii</i>)		1	1	Remove
52477	9	6	Douglas-fir (<i>Pseudotsuga menziesii</i>)		1	1	Remove
52478	10	7	Douglas-fir (<i>Pseudotsuga menziesii</i>)		1	1	Remove
52480	15	10	Douglas-fir (<i>Pseudotsuga menziesii</i>)		1	1	Remove
52481	14	12	Douglas-fir (<i>Pseudotsuga menziesii</i>)		1	1	Remove
52484	15	10	Douglas-fir (<i>Pseudotsuga menziesii</i>)		1	1	Remove
52485	10	6	Douglas-fir (<i>Pseudotsuga menziesii</i>)		1	1	Remove
52487	14	14	Douglas-fir (<i>Pseudotsuga menziesii</i>)	1-sided canopy (W)	1	2	Remove
52488	9	9	Douglas-fir (<i>Pseudotsuga menziesii</i>)		1	1	Remove
52489	13	15	Douglas-fir (<i>Pseudotsuga menziesii</i>)	1-sided canopy (W)	1	2	Remove
52491	12	8	Douglas-fir (<i>Pseudotsuga menziesii</i>)		1	1	Remove
52492	13	14	Douglas-fir (<i>Pseudotsuga menziesii</i>)	1-sided canopy (W)	1	2	Remove
52493	9,10	9	Douglas-fir (<i>Pseudotsuga menziesii</i>)	Codominant with included bark	1	2	Remove
52494	15	16	Douglas-fir (<i>Pseudotsuga menziesii</i>)	1-sided canopy (W)	1	2	Remove
52495	14	12	Douglas-fir (<i>Pseudotsuga menziesii</i>)		1	1	Remove
52496	15	14	Douglas-fir (<i>Pseudotsuga menziesii</i>)		1	1	Remove
52499	15	15	Douglas-fir (<i>Pseudotsuga menziesii</i>)		1	1	Remove
52500	12	14	Douglas-fir (<i>Pseudotsuga menziesii</i>)		1	1	Remove
52501	11	9	Douglas-fir (<i>Pseudotsuga menziesii</i>)		1	1	Remove
52502	13	15	Douglas-fir (<i>Pseudotsuga menziesii</i>)		1	1	Remove
52503	15	10	Douglas-fir (<i>Pseudotsuga menziesii</i>)		1	1	Remove
52504	15	15	Douglas-fir (<i>Pseudotsuga menziesii</i>)		1	1	Remove
52507	12	6	Douglas-fir (<i>Pseudotsuga menziesii</i>)		1	1	Remove
52508	15	14	Douglas-fir (<i>Pseudotsuga menziesii</i>)		1	1	Remove
52510	12	10	Douglas-fir (<i>Pseudotsuga menziesii</i>)		1	1	Remove
52511	12	13	Douglas-fir (<i>Pseudotsuga menziesii</i>)	1-sided canopy (W)	1	2	Remove
52514	30	24	Black Walnut (<i>Juglans nigra</i>)	Dead limbs; 1-sided canopy (W); Good wound wood closure	2	2	Remove
52516	12	13	Douglas-fir (<i>Pseudotsuga menziesii</i>)		1	1	Remove
52517	11	7	Douglas-fir (<i>Pseudotsuga menziesii</i>)		1	1	Remove
52520	13	8	Douglas-fir (<i>Pseudotsuga menziesii</i>)		1	1	Remove
52521	12	9	Douglas-fir (<i>Pseudotsuga menziesii</i>)		1	1	Remove
52522	8	5	Douglas-fir (<i>Pseudotsuga menziesii</i>)		1	1	Remove
52523	8	6	Douglas-fir (<i>Pseudotsuga menziesii</i>)		1	1	Remove
52524	9	10	Douglas-fir (<i>Pseudotsuga menziesii</i>)		1	1	Remove
52525	9	8	Douglas-fir (<i>Pseudotsuga menziesii</i>)		1	1	Remove
52526	10	6	Douglas-fir (<i>Pseudotsuga menziesii</i>)		1	1	Remove
52527	10	8	Douglas-fir (<i>Pseudotsuga menziesii</i>)		1	1	Remove
52529	9	7	Douglas-fir (<i>Pseudotsuga menziesii</i>)		1	1	Remove
52530	15	9	Douglas-fir (<i>Pseudotsuga menziesii</i>)		1	1	Remove
52531	13	10	Douglas-fir (<i>Pseudotsuga menziesii</i>)		1	1	Remove
52532	10	9	Douglas-fir (<i>Pseudotsuga menziesii</i>)		1	1	Remove
52535	12	9	Douglas-fir (<i>Pseudotsuga menziesii</i>)		1	1	Remove
52536	11	9	Douglas-fir (<i>Pseudotsuga menziesii</i>)	Exposed buttress roots (S)	1	1	Remove
52537	9	10	Douglas-fir (<i>Pseudotsuga menziesii</i>)		1	1	Remove
52538	14	23	Douglas-fir (<i>Pseudotsuga menziesii</i>)		1	1	Remove
52540	13	8	Douglas-fir (<i>Pseudotsuga menziesii</i>)		1	1	Remove
52541	11	8	Douglas-fir (<i>Pseudotsuga menziesii</i>)		1	1	Remove
52542	10	8	Douglas-fir (<i>Pseudotsuga menziesii</i>)		1	1	Remove
52544	14	12	Douglas-fir (<i>Pseudotsuga menziesii</i>)		1	1	Remove
52545	12	10	Douglas-fir (<i>Pseudotsuga menziesii</i>)		1	1	Remove

Detailed Tree Inventory for Autumn Sunrise

AKS Job No. 7454 - Evaluation Date: 2/1/2021 - 4/12/2021 - Evaluated by: BRK

Tree #	DBH (in.)	Avg. Crown Radius (ft)	Tree Species Common Name (<i>Scientific name</i>)	Comments	Health Rating*	Structure Rating**	Remove/Preserve
52546	11	10	Douglas-fir (<i>Pseudotsuga menziesii</i>)		1	1	Remove
52547	12	9	Douglas-fir (<i>Pseudotsuga menziesii</i>)	Exposed buttress roots (E)	1	1	Remove
52549	13	10	Douglas-fir (<i>Pseudotsuga menziesii</i>)		1	1	Remove
52550	14	10	Douglas-fir (<i>Pseudotsuga menziesii</i>)		1	1	Remove
52552	13	12	Douglas-fir (<i>Pseudotsuga menziesii</i>)		1	1	Remove
52555	13	12	Douglas-fir (<i>Pseudotsuga menziesii</i>)		1	1	Remove
52556	13	12	Douglas-fir (<i>Pseudotsuga menziesii</i>)		1	1	Remove
52557	14	10	Douglas-fir (<i>Pseudotsuga menziesii</i>)	Codominant with included bark	1	2	Remove
52559	12	10	Douglas-fir (<i>Pseudotsuga menziesii</i>)		1	1	Remove
52561	13	12	Douglas-fir (<i>Pseudotsuga menziesii</i>)		1	1	Remove
52562	13	10	Douglas-fir (<i>Pseudotsuga menziesii</i>)		1	1	Remove
52564	12	13	Douglas-fir (<i>Pseudotsuga menziesii</i>)		1	1	Remove
52565	12	13	Douglas-fir (<i>Pseudotsuga menziesii</i>)		1	1	Remove
52567	23	20	Black Walnut (<i>Juglans nigra</i>)	Dead	3	3	Remove
52568	14	15	Douglas-fir (<i>Pseudotsuga menziesii</i>)		1	1	Remove
52570	13	17	Douglas-fir (<i>Pseudotsuga menziesii</i>)		1	1	Remove
52572	9	10	Douglas-fir (<i>Pseudotsuga menziesii</i>)		1	1	Remove
52573	13	10	Douglas-fir (<i>Pseudotsuga menziesii</i>)		1	1	Remove
52575	13	9	Douglas-fir (<i>Pseudotsuga menziesii</i>)		1	1	Remove
52576	9,9	11	Douglas-fir (<i>Pseudotsuga menziesii</i>)	Codominant base with included bark	1	2	Remove
52577	13	12	Douglas-fir (<i>Pseudotsuga menziesii</i>)		1	1	Remove
52578	10	8	Douglas-fir (<i>Pseudotsuga menziesii</i>)		1	1	Remove
52579	9	10	Douglas-fir (<i>Pseudotsuga menziesii</i>)		1	1	Remove
52581	10	7	Douglas-fir (<i>Pseudotsuga menziesii</i>)		1	1	Remove
52582	9	9	Douglas-fir (<i>Pseudotsuga menziesii</i>)		1	1	Remove
52585	12	8	Douglas-fir (<i>Pseudotsuga menziesii</i>)		1	1	Remove
52586	14	9	Douglas-fir (<i>Pseudotsuga menziesii</i>)		1	1	Remove
52587	14	10	Douglas-fir (<i>Pseudotsuga menziesii</i>)		1	1	Remove
52590	10	7	Douglas-fir (<i>Pseudotsuga menziesii</i>)		1	1	Remove
52591	12	8	Douglas-fir (<i>Pseudotsuga menziesii</i>)		1	1	Remove
52592	8	6	Douglas-fir (<i>Pseudotsuga menziesii</i>)		1	1	Remove
52595	10	8	Douglas-fir (<i>Pseudotsuga menziesii</i>)	Mechanical damage; Seepage	2	1	Remove
52596	11	8	Douglas-fir (<i>Pseudotsuga menziesii</i>)		1	1	Remove
52597	10	8	Douglas-fir (<i>Pseudotsuga menziesii</i>)		1	1	Remove
52598	10	7	Douglas-fir (<i>Pseudotsuga menziesii</i>)		1	1	Remove
52599	8	6	Douglas-fir (<i>Pseudotsuga menziesii</i>)		1	1	Remove
52601	9	9	Douglas-fir (<i>Pseudotsuga menziesii</i>)		1	1	Remove
52602	11	10	Douglas-fir (<i>Pseudotsuga menziesii</i>)		1	1	Remove
52604	15	10	Douglas-fir (<i>Pseudotsuga menziesii</i>)		1	1	Remove
52605	13	9	Douglas-fir (<i>Pseudotsuga menziesii</i>)		1	1	Remove
52607	11	12	Douglas-fir (<i>Pseudotsuga menziesii</i>)		1	1	Remove
52609	14	12	Douglas-fir (<i>Pseudotsuga menziesii</i>)		1	1	Remove
52610	8	9	Douglas-fir (<i>Pseudotsuga menziesii</i>)	Mechanical damage; Seepage	2	1	Remove
52611	11	10	Douglas-fir (<i>Pseudotsuga menziesii</i>)		1	1	Remove
52612	8	6	Douglas-fir (<i>Pseudotsuga menziesii</i>)	Codominant with included bark	1	2	Remove
52613	13	9	Douglas-fir (<i>Pseudotsuga menziesii</i>)		1	1	Remove
52614	10	10	Douglas-fir (<i>Pseudotsuga menziesii</i>)		1	1	Remove
52616	11	10	Douglas-fir (<i>Pseudotsuga menziesii</i>)		1	1	Remove
52617	15	12	Douglas-fir (<i>Pseudotsuga menziesii</i>)		1	1	Remove
52619	11	13	Douglas-fir (<i>Pseudotsuga menziesii</i>)	Split bark with seepage	2	1	Remove
52622	15	13	Douglas-fir (<i>Pseudotsuga menziesii</i>)		1	1	Remove
52624	14	10	Douglas-fir (<i>Pseudotsuga menziesii</i>)	Codominant with included bark	1	2	Remove
52625	10	9	Douglas-fir (<i>Pseudotsuga menziesii</i>)		1	1	Remove
52627	13	12	Douglas-fir (<i>Pseudotsuga menziesii</i>)		1	1	Remove
52629	12	9	Douglas-fir (<i>Pseudotsuga menziesii</i>)		1	1	Remove
52631	10	9	Douglas-fir (<i>Pseudotsuga menziesii</i>)		1	1	Remove
52632	15	12	Douglas-fir (<i>Pseudotsuga menziesii</i>)		1	1	Remove
52633	9	7	Douglas-fir (<i>Pseudotsuga menziesii</i>)		1	1	Remove
52634	14	11	Douglas-fir (<i>Pseudotsuga menziesii</i>)		1	1	Remove
52636	9	6	Douglas-fir (<i>Pseudotsuga menziesii</i>)		1	1	Remove
52637	11	8	Douglas-fir (<i>Pseudotsuga menziesii</i>)		1	1	Remove
52638	13	10	Douglas-fir (<i>Pseudotsuga menziesii</i>)		1	1	Remove
52640	8	5	Douglas-fir (<i>Pseudotsuga menziesii</i>)		1	1	Remove
52641	9	5	Douglas-fir (<i>Pseudotsuga menziesii</i>)		1	1	Remove
52642	18	17	Douglas-fir (<i>Pseudotsuga menziesii</i>)	Codominant top	1	2	Remove
52644	26	17	Douglas-fir (<i>Pseudotsuga menziesii</i>)		1	1	Remove
52645	8	7	Douglas-fir (<i>Pseudotsuga menziesii</i>)	1-sided canopy (W); Codominant top	1	2	Remove
52647	30	20	Douglas-fir (<i>Pseudotsuga menziesii</i>)	1-sided canopy (W)	1	2	Remove
52648	14	16	Douglas-fir (<i>Pseudotsuga menziesii</i>)	1-sided canopy (N)	1	2	Remove

Detailed Tree Inventory for Autumn Sunrise

AKS Job No. 7454 - Evaluation Date: 2/1/2021 - 4/12/2021 - Evaluated by: BRK

Tree #	DBH (in.)	Avg. Crown Radius (ft)	Tree Species Common Name (<i>Scientific name</i>)	Comments	Health Rating*	Structure Rating**	Remove/Preserve
52649	16	20	Douglas-fir (<i>Pseudotsuga menziesii</i>)		1	1	Remove
52650	24	18	Douglas-fir (<i>Pseudotsuga menziesii</i>)	1-sided canopy (S)	1	2	Remove
52652	20	17	Douglas-fir (<i>Pseudotsuga menziesii</i>)		1	1	Remove
52653	18,6	16	Douglas-fir (<i>Pseudotsuga menziesii</i>)	Codominant	1	2	Remove
52654	25	18	Douglas-fir (<i>Pseudotsuga menziesii</i>)	1-sided canopy (S)	1	2	Remove
52656	25	19	Douglas-fir (<i>Pseudotsuga menziesii</i>)	Lean (S); Codominant stems; 1-sided canopy (S); Crooked bole	1	2	Remove
52657	22	18	Douglas-fir (<i>Pseudotsuga menziesii</i>)	1-sided canopy (S)	1	2	Remove
52658	16	16	Douglas-fir (<i>Pseudotsuga menziesii</i>)	1-sided canopy (S)	1	2	Remove
52659	16	17	Douglas-fir (<i>Pseudotsuga menziesii</i>)	1-sided canopy (N)	1	2	Remove
52660	22	15	Douglas-fir (<i>Pseudotsuga menziesii</i>)		1	1	Remove
52664	17	12	Douglas-fir (<i>Pseudotsuga menziesii</i>)		1	1	Remove
52667	10	11	Douglas-fir (<i>Pseudotsuga menziesii</i>)	High canopy; Suppressed; Sparse canopy	2	2	Remove
52669	14	16	Douglas-fir (<i>Pseudotsuga menziesii</i>)	High canopy; 1-sided canopy (E)	1	2	Remove
52670	13	10	Douglas-fir (<i>Pseudotsuga menziesii</i>)	High canopy; Sparse canopy	2	2	Remove
52671	10	15	Douglas-fir (<i>Pseudotsuga menziesii</i>)	High canopy; 1-sided canopy (N)	1	2	Remove
52672	19	18	Douglas-fir (<i>Pseudotsuga menziesii</i>)	High canopy; 1-sided canopy (S)	1	2	Remove
52675	9	14	Douglas-fir (<i>Pseudotsuga menziesii</i>)	High canopy; 1-sided canopy (N)	1	2	Remove
52676	24	20	Douglas-fir (<i>Pseudotsuga menziesii</i>)	1-sided canopy (S);	1	2	Remove
52677	10	7	Douglas-fir (<i>Pseudotsuga menziesii</i>)	High canopy; Sparse canopy; Branch dieback; Epicormic sprouts	3	2	Remove
52678	9	14	Douglas-fir (<i>Pseudotsuga menziesii</i>)	High canopy; Sparse canopy; 1-sided canopy (N)	2	2	Remove
52679	13	11	Douglas-fir (<i>Pseudotsuga menziesii</i>)	High canopy; Sparse canopy; 1-sided canopy (N)	2	2	Remove
52680	11	12	Douglas-fir (<i>Pseudotsuga menziesii</i>)	High canopy; Sparse canopy; 1-sided canopy (S)	2	2	Remove
52683	11	8	Douglas-fir (<i>Pseudotsuga menziesii</i>)	High canopy; Bulges; Epicormic sprouts; Dead branches	3	2	Remove
52684	11	9	Douglas-fir (<i>Pseudotsuga menziesii</i>)	High canopy	1	2	Remove
52686	10	10	Douglas-fir (<i>Pseudotsuga menziesii</i>)	High canopy	1	2	Remove
52687	20	19	Douglas-fir (<i>Pseudotsuga menziesii</i>)	1-sided canopy (S)	1	2	Remove
52688	17	17	Douglas-fir (<i>Pseudotsuga menziesii</i>)	1-sided canopy (S)	1	2	Remove
52690	10	8	Douglas-fir (<i>Pseudotsuga menziesii</i>)	High canopy; Bulges; Epicormic sprouts; Dead branches	3	2	Remove
52691	13	15	Douglas-fir (<i>Pseudotsuga menziesii</i>)	1-sided canopy (W)	1	2	Remove
52694	26	20	Douglas-fir (<i>Pseudotsuga menziesii</i>)	1-sided canopy (W)	1	2	Remove
52696	8	13	Douglas-fir (<i>Pseudotsuga menziesii</i>)	High canopy; Suppressed; Sparse canopy	2	2	Remove
52697	16	16	Douglas-fir (<i>Pseudotsuga menziesii</i>)	High canopy; 1-sided canopy (N)	1	2	Remove
52698	34	21	Douglas-fir (<i>Pseudotsuga menziesii</i>)	1-sided canopy (W)	1	2	Remove
52700	11	20	Douglas-fir (<i>Pseudotsuga menziesii</i>)	Suppressed; crooked top; 1-sided canopy (W)	2	2	Remove
52701	8	9	Douglas-fir (<i>Pseudotsuga menziesii</i>)	1-sided canopy (W)	1	2	Remove
52704	8	5	Douglas-fir (<i>Pseudotsuga menziesii</i>)		1	1	Remove
52706	13	11	Douglas-fir (<i>Pseudotsuga menziesii</i>)		1	1	Remove
52707	15	10	Douglas-fir (<i>Pseudotsuga menziesii</i>)	Codominant top with included bark	1	2	Remove
52708	9	7	Douglas-fir (<i>Pseudotsuga menziesii</i>)		1	1	Remove
52709	10	7	Douglas-fir (<i>Pseudotsuga menziesii</i>)		1	1	Remove
52711	11	9	Douglas-fir (<i>Pseudotsuga menziesii</i>)		1	1	Remove
52712	13	7	Douglas-fir (<i>Pseudotsuga menziesii</i>)		1	1	Remove
52713	13	11	Douglas-fir (<i>Pseudotsuga menziesii</i>)		1	1	Remove
52714	12	8	Douglas-fir (<i>Pseudotsuga menziesii</i>)		1	1	Remove
52715	13	8	Douglas-fir (<i>Pseudotsuga menziesii</i>)		1	1	Remove
52717	10	6	Douglas-fir (<i>Pseudotsuga menziesii</i>)		1	1	Remove
52718	11	9	Douglas-fir (<i>Pseudotsuga menziesii</i>)		1	1	Remove
52719	10	9	Douglas-fir (<i>Pseudotsuga menziesii</i>)		1	1	Remove
52720	14	8	Douglas-fir (<i>Pseudotsuga menziesii</i>)		1	1	Remove
52721	12	8	Douglas-fir (<i>Pseudotsuga menziesii</i>)		1	1	Remove
52724	12	9	Douglas-fir (<i>Pseudotsuga menziesii</i>)		1	1	Remove
52725	11	8	Douglas-fir (<i>Pseudotsuga menziesii</i>)		1	1	Remove
52727	11	7	Douglas-fir (<i>Pseudotsuga menziesii</i>)		1	1	Remove
52728	12	8	Douglas-fir (<i>Pseudotsuga menziesii</i>)		1	1	Remove
52729	10	9	Douglas-fir (<i>Pseudotsuga menziesii</i>)		1	1	Remove
52731	11	8	Douglas-fir (<i>Pseudotsuga menziesii</i>)		1	1	Remove
52733	13	9	Douglas-fir (<i>Pseudotsuga menziesii</i>)		1	1	Remove
52735	8	7	Douglas-fir (<i>Pseudotsuga menziesii</i>)		1	1	Remove
52737	9	7	Douglas-fir (<i>Pseudotsuga menziesii</i>)		1	1	Remove
52738	13	10	Douglas-fir (<i>Pseudotsuga menziesii</i>)		1	1	Remove
52740	10	6	Douglas-fir (<i>Pseudotsuga menziesii</i>)		1	1	Remove
52741	13	7	Douglas-fir (<i>Pseudotsuga menziesii</i>)		1	1	Remove
52742	9	9	Douglas-fir (<i>Pseudotsuga menziesii</i>)	Mechanical damage; Seepage; broken branches	2	2	Remove
52744	8	7	Douglas-fir (<i>Pseudotsuga menziesii</i>)		1	1	Remove
52745	9	9	Douglas-fir (<i>Pseudotsuga menziesii</i>)		1	1	Remove
52746	8	6	Douglas-fir (<i>Pseudotsuga menziesii</i>)		1	1	Remove
52748	13	11	Douglas-fir (<i>Pseudotsuga menziesii</i>)		1	1	Remove

Detailed Tree Inventory for Autumn Sunrise

AKS Job No. 7454 - Evaluation Date: 2/1/2021 - 4/12/2021 - Evaluated by: BRK

Tree #	DBH (in.)	Avg. Crown Radius (ft)	Tree Species Common Name (<i>Scientific name</i>)	Comments	Health Rating*	Structure Rating**	Remove/Preserve
52749	11	8	Douglas-fir (<i>Pseudotsuga menziesii</i>)		1	1	Remove
52750	13	13	Douglas-fir (<i>Pseudotsuga menziesii</i>)		1	1	Remove
52752	9	12	Douglas-fir (<i>Pseudotsuga menziesii</i>)		1	1	Remove
52753	11	7	Douglas-fir (<i>Pseudotsuga menziesii</i>)		1	1	Remove
52754	9	7	Douglas-fir (<i>Pseudotsuga menziesii</i>)		1	1	Remove
52755	8	7	Douglas-fir (<i>Pseudotsuga menziesii</i>)		1	1	Remove
52758	8	6	Douglas-fir (<i>Pseudotsuga menziesii</i>)		1	1	Remove
52759	9	9	Douglas-fir (<i>Pseudotsuga menziesii</i>)		1	1	Remove
52762	11	9	Douglas-fir (<i>Pseudotsuga menziesii</i>)	Codominant with included bark	1	2	Remove
52763	12	6	Douglas-fir (<i>Pseudotsuga menziesii</i>)		1	1	Remove
52764	11	7	Douglas-fir (<i>Pseudotsuga menziesii</i>)		1	1	Remove
52765	12	12	Douglas-fir (<i>Pseudotsuga menziesii</i>)		1	1	Remove
52767	11	7	Douglas-fir (<i>Pseudotsuga menziesii</i>)		1	1	Remove
52768	8	7	Douglas-fir (<i>Pseudotsuga menziesii</i>)		1	1	Remove
52769	8	6	Douglas-fir (<i>Pseudotsuga menziesii</i>)		1	1	Remove
52770	14	10	Douglas-fir (<i>Pseudotsuga menziesii</i>)		1	1	Remove
52771	8	5	Douglas-fir (<i>Pseudotsuga menziesii</i>)		1	1	Remove
52772	10	7	Douglas-fir (<i>Pseudotsuga menziesii</i>)		1	1	Remove
52774	10	8	Douglas-fir (<i>Pseudotsuga menziesii</i>)		1	1	Remove
52777	19	14	Douglas-fir (<i>Pseudotsuga menziesii</i>)		1	1	Remove
52780	10	9	Douglas-fir (<i>Pseudotsuga menziesii</i>)		1	1	Remove
52781	10	6	Douglas-fir (<i>Pseudotsuga menziesii</i>)		1	1	Remove
52783	10	9	Douglas-fir (<i>Pseudotsuga menziesii</i>)		1	1	Remove
52785	15	11	Douglas-fir (<i>Pseudotsuga menziesii</i>)		1	1	Remove
52788	12	9	Douglas-fir (<i>Pseudotsuga menziesii</i>)		1	1	Remove
52789	10	8	Douglas-fir (<i>Pseudotsuga menziesii</i>)	Mechanical damage with seepage at base	1	2	Remove
52816	17	13	Douglas-fir (<i>Pseudotsuga menziesii</i>)		1	1	Remove
52817	23	18	Douglas-fir (<i>Pseudotsuga menziesii</i>)		1	1	Remove
52819	23	22	Douglas-fir (<i>Pseudotsuga menziesii</i>)	1-sided canopy (S)	1	2	Remove
52820	21	20	Douglas-fir (<i>Pseudotsuga menziesii</i>)	1-sided canopy (N)	1	2	Preserve
52821	26	23	Douglas-fir (<i>Pseudotsuga menziesii</i>)	1-sided canopy (E)	1	2	Remove
52822	8	0	Douglas-fir (<i>Pseudotsuga menziesii</i>)	Dead	3	3	Preserve
52827	12	11	Douglas-fir (<i>Pseudotsuga menziesii</i>)	Broken top	2	3	Preserve
52828	38	30	Douglas-fir (<i>Pseudotsuga menziesii</i>)	1-sided canopy (E)	1	2	Remove
52830	30	25	Douglas-fir (<i>Pseudotsuga menziesii</i>)	1-sided canopy (S)	1	2	Remove
52831	59	25	Douglas-fir (<i>Pseudotsuga menziesii</i>)	1-sided canopy (N)	1	2	Remove
52832	23	25	Douglas-fir (<i>Pseudotsuga menziesii</i>)	1-sided canopy (N)	1	2	Remove
52833	20	25	Douglas-fir (<i>Pseudotsuga menziesii</i>)	Deformed bole; Weakly attached scaffold branches; Broken codominant stems; 1-sided canopy (W)	2	3	Remove
52835	20	14	Douglas-fir (<i>Pseudotsuga menziesii</i>)		1	1	Remove
52836	21	10	Douglas-fir (<i>Pseudotsuga menziesii</i>)		1	1	Remove
52837	19	15	Douglas-fir (<i>Pseudotsuga menziesii</i>)	1-sided canopy (S)	1	2	Remove
52838	23	17	Douglas-fir (<i>Pseudotsuga menziesii</i>)	Crooked bole	1	2	Remove
52839	20	16	Douglas-fir (<i>Pseudotsuga menziesii</i>)		1	1	Remove
52840	20	16	Douglas-fir (<i>Pseudotsuga menziesii</i>)	1-sided canopy (W)	1	2	Remove
52841	19	18	Douglas-fir (<i>Pseudotsuga menziesii</i>)	1-sided canopy (W)	1	2	Remove
52844	14	9	Douglas-fir (<i>Pseudotsuga menziesii</i>)	Butt sweep	1	2	Remove
52845	24	17	Douglas-fir (<i>Pseudotsuga menziesii</i>)		1	1	Remove
52848	8	6	Douglas-fir (<i>Pseudotsuga menziesii</i>)	Broken top	3	2	Preserve
52849	9	8	Douglas-fir (<i>Pseudotsuga menziesii</i>)	High canopy	1	2	Preserve
52850	14	15	Douglas-fir (<i>Pseudotsuga menziesii</i>)	1-sided canopy (N)	1	2	Preserve
52851	14	14	Douglas-fir (<i>Pseudotsuga menziesii</i>)	1-sided canopy (N)	1	2	Preserve
52854	9	15	Douglas-fir (<i>Pseudotsuga menziesii</i>)	1-sided canopy (W)	1	2	Preserve
52855	10	12	Douglas-fir (<i>Pseudotsuga menziesii</i>)	1-sided canopy (W)	1	2	Preserve
52856	11	10	Douglas-fir (<i>Pseudotsuga menziesii</i>)	High canopy	1	2	Preserve
52861	10	11	Douglas-fir (<i>Pseudotsuga menziesii</i>)	High canopy	1	2	Preserve
52862	12	13	Douglas-fir (<i>Pseudotsuga menziesii</i>)	1-sided canopy (N)	1	2	Preserve
52863	14	15	Douglas-fir (<i>Pseudotsuga menziesii</i>)	1-sided canopy (N)	1	2	Preserve
52864	14	16	Douglas-fir (<i>Pseudotsuga menziesii</i>)		1	1	Preserve
52867	13	9	Douglas-fir (<i>Pseudotsuga menziesii</i>)		1	1	Preserve
52868	13	10	Douglas-fir (<i>Pseudotsuga menziesii</i>)	High canopy	1	2	Preserve
52872	36	18	Douglas-fir (<i>Pseudotsuga menziesii</i>)		1	1	Remove
52873	10	7	Douglas-fir (<i>Pseudotsuga menziesii</i>)		1	1	Preserve
52874	24	19	Douglas-fir (<i>Pseudotsuga menziesii</i>)		1	1	Remove
52876	24	17	Douglas-fir (<i>Pseudotsuga menziesii</i>)		1	1	Remove
52877	21	15	Douglas-fir (<i>Pseudotsuga menziesii</i>)	1-sided canopy (S)	1	2	Remove
52878	20	16	Douglas-fir (<i>Pseudotsuga menziesii</i>)	1-sided canopy (W)	1	2	Remove
52879	21	16	Douglas-fir (<i>Pseudotsuga menziesii</i>)	1-sided canopy (E)	1	2	Remove
52881	24	15	Douglas-fir (<i>Pseudotsuga menziesii</i>)		1	1	Remove

Detailed Tree Inventory for Autumn Sunrise

AKS Job No. 7454 - Evaluation Date: 2/1/2021 - 4/12/2021 - Evaluated by: BRK

Tree #	DBH (in.)	Avg. Crown Radius (ft)	Tree Species Common Name (<i>Scientific name</i>)	Comments	Health Rating*	Structure Rating**	Remove/Preserve
52882	13	15	Douglas-fir (<i>Pseudotsuga menziesii</i>)		1	1	Remove
52883	16	16	Douglas-fir (<i>Pseudotsuga menziesii</i>)		1	1	Remove
52884	17	17	Douglas-fir (<i>Pseudotsuga menziesii</i>)		1	1	Remove
52887	32	15	Douglas-fir (<i>Pseudotsuga menziesii</i>)		1	1	Remove
52890	12	10	Douglas-fir (<i>Pseudotsuga menziesii</i>)		1	1	Preserve
52893	15	14	Douglas-fir (<i>Pseudotsuga menziesii</i>)		1	1	Preserve
52895	11	15	Douglas-fir (<i>Pseudotsuga menziesii</i>)	1-sided canopy (N)	1	2	Preserve
52896	13	12	Douglas-fir (<i>Pseudotsuga menziesii</i>)		1	1	Preserve
52897	11	9	Douglas-fir (<i>Pseudotsuga menziesii</i>)	High canopy	1	2	Preserve
52898	11	10	Douglas-fir (<i>Pseudotsuga menziesii</i>)		1	1	Preserve
52900	8	10	Douglas-fir (<i>Pseudotsuga menziesii</i>)	High canopy	1	2	Preserve
52904	10	7	Douglas-fir (<i>Pseudotsuga menziesii</i>)		1	1	Remove
52910	10	10	Douglas-fir (<i>Pseudotsuga menziesii</i>)		1	1	Remove
52921	10	8	Douglas-fir (<i>Pseudotsuga menziesii</i>)		1	1	Remove
52922	8	5	Douglas-fir (<i>Pseudotsuga menziesii</i>)	Codominant stem with included bark	1	2	Remove
52925	9	5	Douglas-fir (<i>Pseudotsuga menziesii</i>)		1	1	Remove
52926	10	7	Douglas-fir (<i>Pseudotsuga menziesii</i>)		1	1	Remove
52927	9	6	Douglas-fir (<i>Pseudotsuga menziesii</i>)		1	1	Remove
52928	8	4	Douglas-fir (<i>Pseudotsuga menziesii</i>)		1	1	Remove
52930	11	6	Douglas-fir (<i>Pseudotsuga menziesii</i>)		1	1	Remove
52932	8	7	Douglas-fir (<i>Pseudotsuga menziesii</i>)		1	1	Remove
52933	8	6	Douglas-fir (<i>Pseudotsuga menziesii</i>)		1	1	Remove
52935	9	8	Douglas-fir (<i>Pseudotsuga menziesii</i>)		1	1	Remove
52937	8	4	Douglas-fir (<i>Pseudotsuga menziesii</i>)		1	1	Remove
52938	10	7	Douglas-fir (<i>Pseudotsuga menziesii</i>)		1	1	Remove
52939	9	6	Douglas-fir (<i>Pseudotsuga menziesii</i>)		1	1	Remove
52941	11	5	Douglas-fir (<i>Pseudotsuga menziesii</i>)		1	1	Remove
52942	9	7	Douglas-fir (<i>Pseudotsuga menziesii</i>)	Codominant top with included bark	1	2	Remove
52943	10	5	Douglas-fir (<i>Pseudotsuga menziesii</i>)		1	1	Remove
52944	8	5	Douglas-fir (<i>Pseudotsuga menziesii</i>)		1	1	Remove
52945	11	7	Douglas-fir (<i>Pseudotsuga menziesii</i>)		1	1	Remove
52946	10	5	Douglas-fir (<i>Pseudotsuga menziesii</i>)		1	1	Remove
52947	12	10	Douglas-fir (<i>Pseudotsuga menziesii</i>)		1	1	Remove
52949	11	5	Douglas-fir (<i>Pseudotsuga menziesii</i>)		1	1	Remove
52950	11	5	Douglas-fir (<i>Pseudotsuga menziesii</i>)		1	1	Remove
52952	10	8	Douglas-fir (<i>Pseudotsuga menziesii</i>)		1	1	Remove
52953	10	5	Douglas-fir (<i>Pseudotsuga menziesii</i>)		1	1	Remove
52955	8	4	Douglas-fir (<i>Pseudotsuga menziesii</i>)		1	1	Remove
52956	9	6	Douglas-fir (<i>Pseudotsuga menziesii</i>)		1	1	Remove
52957	8	0	Douglas-fir (<i>Pseudotsuga menziesii</i>)	Dead	3	3	Remove
52958	11	9	Douglas-fir (<i>Pseudotsuga menziesii</i>)		1	1	Remove
52959	11	11	Douglas-fir (<i>Pseudotsuga menziesii</i>)		1	1	Remove
52960	9	7	Douglas-fir (<i>Pseudotsuga menziesii</i>)		1	1	Remove
52962	9	8	Douglas-fir (<i>Pseudotsuga menziesii</i>)		1	1	Remove
52963	9	6	Douglas-fir (<i>Pseudotsuga menziesii</i>)		1	1	Remove
52967	13	11	Douglas-fir (<i>Pseudotsuga menziesii</i>)	Mechanical damage with seepage	2	1	Remove
52968	10	7	Douglas-fir (<i>Pseudotsuga menziesii</i>)	Mechanical damage with seepage; Several impacts up bole	2	2	Remove
52972	23	18	Douglas-fir (<i>Pseudotsuga menziesii</i>)		1	1	Remove
52973	8	8	Douglas-fir (<i>Pseudotsuga menziesii</i>)	Several small cavities with seepage	2	1	Remove
52978	8	6	Douglas-fir (<i>Pseudotsuga menziesii</i>)	Sparse canopy	2	2	Remove
52979	9	6	Douglas-fir (<i>Pseudotsuga menziesii</i>)		1	1	Remove
52980	10	7	Douglas-fir (<i>Pseudotsuga menziesii</i>)		1	1	Remove
52981	11	8	Douglas-fir (<i>Pseudotsuga menziesii</i>)		1	1	Remove
52982	11	10	Douglas-fir (<i>Pseudotsuga menziesii</i>)		1	1	Remove
52984	12	8	Douglas-fir (<i>Pseudotsuga menziesii</i>)		1	1	Remove
52985	12	18	Douglas-fir (<i>Pseudotsuga menziesii</i>)		1	1	Remove
52986	12	18	Douglas-fir (<i>Pseudotsuga menziesii</i>)		1	1	Remove
52989	14	16	Douglas-fir (<i>Pseudotsuga menziesii</i>)		1	1	Remove
52992	13	15	Douglas-fir (<i>Pseudotsuga menziesii</i>)		1	1	Remove
52993	9	10	Douglas-fir (<i>Pseudotsuga menziesii</i>)		1	1	Remove
52994	14	13	Douglas-fir (<i>Pseudotsuga menziesii</i>)		1	1	Remove
52996	8	8	Douglas-fir (<i>Pseudotsuga menziesii</i>)		1	1	Remove
52997	15	10	Douglas-fir (<i>Pseudotsuga menziesii</i>)		1	1	Remove
52998	9	8	Douglas-fir (<i>Pseudotsuga menziesii</i>)		1	1	Remove
53000	10	9	Douglas-fir (<i>Pseudotsuga menziesii</i>)		1	1	Remove
53001	14	7	Douglas-fir (<i>Pseudotsuga menziesii</i>)	Crooked bole	1	2	Remove
53002	11	8	Douglas-fir (<i>Pseudotsuga menziesii</i>)		1	1	Remove
53003	13	8	Douglas-fir (<i>Pseudotsuga menziesii</i>)		1	1	Remove
53005	8	8	Douglas-fir (<i>Pseudotsuga menziesii</i>)		1	1	Remove

Detailed Tree Inventory for Autumn Sunrise

AKS Job No. 7454 - Evaluation Date: 2/1/2021 - 4/12/2021 - Evaluated by: BRK

Tree #	DBH (in.)	Avg. Crown Radius (ft)	Tree Species Common Name (<i>Scientific name</i>)	Comments	Health Rating*	Structure Rating**	Remove/Preserve
53006	15	9	Douglas-fir (<i>Pseudotsuga menziesii</i>)		1	1	Remove
53008	14	8	Douglas-fir (<i>Pseudotsuga menziesii</i>)		1	1	Remove
53009	9	7	Douglas-fir (<i>Pseudotsuga menziesii</i>)		1	1	Remove
53011	13	10	Douglas-fir (<i>Pseudotsuga menziesii</i>)		1	1	Remove
53012	9	7	Douglas-fir (<i>Pseudotsuga menziesii</i>)		1	1	Remove
53013	8	6	Douglas-fir (<i>Pseudotsuga menziesii</i>)		1	1	Remove
53014	10	6	Douglas-fir (<i>Pseudotsuga menziesii</i>)	Crooked bole	1	2	Remove
53015	11	7	Douglas-fir (<i>Pseudotsuga menziesii</i>)		1	1	Remove
53016	10	8	Douglas-fir (<i>Pseudotsuga menziesii</i>)		1	1	Remove
53018	14	11	Douglas-fir (<i>Pseudotsuga menziesii</i>)		1	1	Remove
53019	12	8	Douglas-fir (<i>Pseudotsuga menziesii</i>)		1	1	Remove
53020	11	10	Douglas-fir (<i>Pseudotsuga menziesii</i>)		1	1	Remove
53022	13	11	Douglas-fir (<i>Pseudotsuga menziesii</i>)		1	1	Remove
53023	8	4	Douglas-fir (<i>Pseudotsuga menziesii</i>)	Crooked bole; Suppressed	2	2	Remove
53024	11	8	Douglas-fir (<i>Pseudotsuga menziesii</i>)		1	1	Remove
53025	10	5	Douglas-fir (<i>Pseudotsuga menziesii</i>)		1	1	Remove
53026	12	7	Douglas-fir (<i>Pseudotsuga menziesii</i>)		1	1	Remove
53027	8	5	Douglas-fir (<i>Pseudotsuga menziesii</i>)		1	1	Remove
53028	13	8	Douglas-fir (<i>Pseudotsuga menziesii</i>)		1	1	Remove
53030	13	9	Douglas-fir (<i>Pseudotsuga menziesii</i>)		1	1	Remove
53032	8	8	Douglas-fir (<i>Pseudotsuga menziesii</i>)		1	1	Remove
53035	8	3	Douglas-fir (<i>Pseudotsuga menziesii</i>)	Suppressed	2	2	Remove
53036	11	10	Douglas-fir (<i>Pseudotsuga menziesii</i>)		1	1	Remove
53037	15	12	Douglas-fir (<i>Pseudotsuga menziesii</i>)		1	1	Remove
53039	8	6	Douglas-fir (<i>Pseudotsuga menziesii</i>)	Suppressed; Codominant with included bark	2	2	Remove
53040	8	7	Douglas-fir (<i>Pseudotsuga menziesii</i>)		1	1	Remove
53041	10	7	Douglas-fir (<i>Pseudotsuga menziesii</i>)		1	1	Remove
53042	12	8	Douglas-fir (<i>Pseudotsuga menziesii</i>)		1	1	Remove
53043	12	8	Douglas-fir (<i>Pseudotsuga menziesii</i>)		1	1	Remove
53045	15	10	Douglas-fir (<i>Pseudotsuga menziesii</i>)		1	1	Remove
53046	12	8	Douglas-fir (<i>Pseudotsuga menziesii</i>)		1	1	Remove
53048	16	12	Douglas-fir (<i>Pseudotsuga menziesii</i>)	Codominant with included bark	1	2	Remove
53050	12	9	Douglas-fir (<i>Pseudotsuga menziesii</i>)		1	1	Remove
53051	12	11	Douglas-fir (<i>Pseudotsuga menziesii</i>)		1	1	Remove
53052	8	8	Douglas-fir (<i>Pseudotsuga menziesii</i>)		1	1	Remove
53053	8	7	Douglas-fir (<i>Pseudotsuga menziesii</i>)		1	1	Remove
53054	13	9	Douglas-fir (<i>Pseudotsuga menziesii</i>)	Mechanical damage with seepage	2	1	Remove
53056	11	8	Douglas-fir (<i>Pseudotsuga menziesii</i>)		1	1	Remove
53057	14	10	Douglas-fir (<i>Pseudotsuga menziesii</i>)	Mechanical damage with seepage	2	1	Remove
53059	8	0	Douglas-fir (<i>Pseudotsuga menziesii</i>)	Dead	3	3	Remove
53061	12	8	Douglas-fir (<i>Pseudotsuga menziesii</i>)		1	1	Remove
53062	12	8	Douglas-fir (<i>Pseudotsuga menziesii</i>)		1	1	Remove
53063	9	9	Douglas-fir (<i>Pseudotsuga menziesii</i>)		1	1	Remove
53064	10	7	Douglas-fir (<i>Pseudotsuga menziesii</i>)		1	1	Remove
53065	13	10	Douglas-fir (<i>Pseudotsuga menziesii</i>)		1	1	Remove
53066	12	14	Douglas-fir (<i>Pseudotsuga menziesii</i>)		1	1	Remove
53067	14	10	Douglas-fir (<i>Pseudotsuga menziesii</i>)		1	1	Remove
53068	10	9	Douglas-fir (<i>Pseudotsuga menziesii</i>)		1	1	Remove
53070	13	8	Douglas-fir (<i>Pseudotsuga menziesii</i>)		1	1	Remove
53071	9	9	Douglas-fir (<i>Pseudotsuga menziesii</i>)	Mechanical damage with seepage	2	1	Remove
53072	13	10	Douglas-fir (<i>Pseudotsuga menziesii</i>)		1	1	Remove
53073	12	10	Douglas-fir (<i>Pseudotsuga menziesii</i>)	Mechanical damage with seepage	2	1	Remove
53075	8	0	Douglas-fir (<i>Pseudotsuga menziesii</i>)	Dead	3	3	Remove
53076	13	11	Douglas-fir (<i>Pseudotsuga menziesii</i>)		1	1	Remove
53077	11	8	Douglas-fir (<i>Pseudotsuga menziesii</i>)		1	1	Remove
53078	13	9	Douglas-fir (<i>Pseudotsuga menziesii</i>)		1	1	Remove
53080	10	7	Douglas-fir (<i>Pseudotsuga menziesii</i>)		1	1	Remove
53081	13	11	Douglas-fir (<i>Pseudotsuga menziesii</i>)		1	1	Remove
53082	15	12	Douglas-fir (<i>Pseudotsuga menziesii</i>)		1	1	Remove
53083	11	10	Douglas-fir (<i>Pseudotsuga menziesii</i>)		1	1	Remove
53084	8	0	Douglas-fir (<i>Pseudotsuga menziesii</i>)		1	1	Remove
53085	29	18	Black Walnut (<i>Juglans nigra</i>)	Dead limbs; Several cavities at base	2	2	Remove
53086	10	10	Douglas-fir (<i>Pseudotsuga menziesii</i>)		1	1	Remove
53088	10	8	Douglas-fir (<i>Pseudotsuga menziesii</i>)		1	1	Remove
53089	9	10	Douglas-fir (<i>Pseudotsuga menziesii</i>)	1-sided canopy (S)	1	2	Remove
53090	9	10	Douglas-fir (<i>Pseudotsuga menziesii</i>)		1	1	Remove
53092	10	11	Douglas-fir (<i>Pseudotsuga menziesii</i>)	High canopy	1	2	Remove
53095	8	12	Douglas-fir (<i>Pseudotsuga menziesii</i>)	Crooked bole	1	2	Remove
53096	8	9	Douglas-fir (<i>Pseudotsuga menziesii</i>)	1-sided canopy (S)	1	2	Remove

Detailed Tree Inventory for Autumn Sunrise

AKS Job No. 7454 - Evaluation Date: 2/1/2021 - 4/12/2021 - Evaluated by: BRK

Tree #	DBH (in.)	Avg. Crown Radius (ft)	Tree Species Common Name (<i>Scientific name</i>)	Comments	Health Rating*	Structure Rating**	Remove/Preserve
53098	10	11	Douglas-fir (<i>Pseudotsuga menziesii</i>)	High canopy	1	2	Remove
53099	12	13	Douglas-fir (<i>Pseudotsuga menziesii</i>)	1-sided canopy (S)	1	2	Remove
53100	13	11	Douglas-fir (<i>Pseudotsuga menziesii</i>)	1-sided canopy (S)	1	2	Remove
53102	10	9	Douglas-fir (<i>Pseudotsuga menziesii</i>)	High canopy	1	2	Preserve
53103	11	11	Douglas-fir (<i>Pseudotsuga menziesii</i>)		1	1	Preserve
53104	8	9	Douglas-fir (<i>Pseudotsuga menziesii</i>)	High canopy; Sparse canopy	2	2	Preserve
53110	14	14	Douglas-fir (<i>Pseudotsuga menziesii</i>)		1	1	Remove
53112	14	14	Douglas-fir (<i>Pseudotsuga menziesii</i>)		1	1	Remove
53115	14	16	Douglas-fir (<i>Pseudotsuga menziesii</i>)		1	1	Remove
53116	10	7	Douglas-fir (<i>Pseudotsuga menziesii</i>)	Crooked bole	1	2	Remove
53118	12	7	Douglas-fir (<i>Pseudotsuga menziesii</i>)		1	1	Remove
53119	9	5	Douglas-fir (<i>Pseudotsuga menziesii</i>)		1	1	Remove
53120	13	11	Douglas-fir (<i>Pseudotsuga menziesii</i>)		1	1	Remove
53122	8	9	Douglas-fir (<i>Pseudotsuga menziesii</i>)		1	1	Remove
53123	13	8	Douglas-fir (<i>Pseudotsuga menziesii</i>)		1	1	Remove
53124	8	7	Douglas-fir (<i>Pseudotsuga menziesii</i>)		1	1	Remove
53125	10	9	Douglas-fir (<i>Pseudotsuga menziesii</i>)		1	1	Remove
53127	11	11	Douglas-fir (<i>Pseudotsuga menziesii</i>)		1	1	Remove
53128	14	10	Douglas-fir (<i>Pseudotsuga menziesii</i>)		1	1	Remove
53129	11	10	Douglas-fir (<i>Pseudotsuga menziesii</i>)		1	1	Remove
53131	14	15	Douglas-fir (<i>Pseudotsuga menziesii</i>)		1	2	Remove
53134	12	14	Douglas-fir (<i>Pseudotsuga menziesii</i>)		1	1	Remove
53135	15	14	Douglas-fir (<i>Pseudotsuga menziesii</i>)		1	1	Remove
53137	16	17	Douglas-fir (<i>Pseudotsuga menziesii</i>)		1	1	Remove
53139	8	8	Douglas-fir (<i>Pseudotsuga menziesii</i>)		1	1	Remove
53140	12	10	Douglas-fir (<i>Pseudotsuga menziesii</i>)		1	1	Remove
53141	13	9	Douglas-fir (<i>Pseudotsuga menziesii</i>)		1	1	Remove
53142	13	11	Douglas-fir (<i>Pseudotsuga menziesii</i>)		1	1	Remove
53144	8	9	Douglas-fir (<i>Pseudotsuga menziesii</i>)		1	1	Remove
53146	12	8	Douglas-fir (<i>Pseudotsuga menziesii</i>)		1	1	Remove
53148	8	5	Douglas-fir (<i>Pseudotsuga menziesii</i>)		1	1	Remove
53149	13	10	Douglas-fir (<i>Pseudotsuga menziesii</i>)		1	1	Remove
53151	11	7	Douglas-fir (<i>Pseudotsuga menziesii</i>)		1	1	Remove
53152	11	8	Douglas-fir (<i>Pseudotsuga menziesii</i>)		1	1	Remove
53153	10	11	Douglas-fir (<i>Pseudotsuga menziesii</i>)		1	1	Remove
53154	13	13	Douglas-fir (<i>Pseudotsuga menziesii</i>)		1	1	Remove
53156	9	10	Douglas-fir (<i>Pseudotsuga menziesii</i>)		1	1	Remove
53157	13	8	Douglas-fir (<i>Pseudotsuga menziesii</i>)		1	1	Remove
53159	11	9	Douglas-fir (<i>Pseudotsuga menziesii</i>)		1	1	Remove
53160	11	9	Douglas-fir (<i>Pseudotsuga menziesii</i>)		1	1	Remove
53161	10,11	11	Douglas-fir (<i>Pseudotsuga menziesii</i>)	Codominant with included bark	1	2	Remove
53164	14	13	Douglas-fir (<i>Pseudotsuga menziesii</i>)		1	1	Remove
53166	9	10	Douglas-fir (<i>Pseudotsuga menziesii</i>)		1	1	Remove
53168	16	8	Douglas-fir (<i>Pseudotsuga menziesii</i>)		1	1	Remove
53171	15	14	Douglas-fir (<i>Pseudotsuga menziesii</i>)		1	1	Remove
53173	10	9	Douglas-fir (<i>Pseudotsuga menziesii</i>)		1	1	Remove
53174	10	7	Douglas-fir (<i>Pseudotsuga menziesii</i>)		1	1	Remove
53175	15	7	Douglas-fir (<i>Pseudotsuga menziesii</i>)		1	1	Remove
53176	11	7	Douglas-fir (<i>Pseudotsuga menziesii</i>)		1	1	Remove
53178	12	10	Douglas-fir (<i>Pseudotsuga menziesii</i>)		1	1	Remove
53179	10	7	Douglas-fir (<i>Pseudotsuga menziesii</i>)		1	1	Remove
53181	13	9	Douglas-fir (<i>Pseudotsuga menziesii</i>)		1	1	Remove
53183	15	18	Douglas-fir (<i>Pseudotsuga menziesii</i>)	1-sided canopy (E)	1	2	Remove
53185	15	17	Douglas-fir (<i>Pseudotsuga menziesii</i>)	1-sided canopy (E)	1	2	Remove
53187	13	12	Douglas-fir (<i>Pseudotsuga menziesii</i>)	Codominant with included bark	1	2	Remove
53188	12	9	Douglas-fir (<i>Pseudotsuga menziesii</i>)		1	1	Remove
53189	14	8	Douglas-fir (<i>Pseudotsuga menziesii</i>)		1	1	Remove
53190	9	7	Douglas-fir (<i>Pseudotsuga menziesii</i>)		1	1	Remove
53191	14	14	Douglas-fir (<i>Pseudotsuga menziesii</i>)		1	1	Remove
53192	15	15	Douglas-fir (<i>Pseudotsuga menziesii</i>)		1	1	Remove
53193	12	13	Douglas-fir (<i>Pseudotsuga menziesii</i>)		1	1	Remove
53194	8	9	Douglas-fir (<i>Pseudotsuga menziesii</i>)		1	1	Remove
53195	9	7	Douglas-fir (<i>Pseudotsuga menziesii</i>)		1	1	Remove
53196	10	8	Douglas-fir (<i>Pseudotsuga menziesii</i>)		1	1	Remove
53197	9,10	8	Douglas-fir (<i>Pseudotsuga menziesii</i>)	Codominant with included bark	1	2	Remove
53199	14	12	Douglas-fir (<i>Pseudotsuga menziesii</i>)		1	1	Remove
53200	9	6	Douglas-fir (<i>Pseudotsuga menziesii</i>)		1	1	Remove
53203	14	13	Douglas-fir (<i>Pseudotsuga menziesii</i>)		1	1	Remove
53204	13	8	Douglas-fir (<i>Pseudotsuga menziesii</i>)		1	1	Remove

Detailed Tree Inventory for Autumn Sunrise

AKS Job No. 7454 - Evaluation Date: 2/1/2021 - 4/12/2021 - Evaluated by: BRK

Tree #	DBH (in.)	Avg. Crown Radius (ft)	Tree Species Common Name (<i>Scientific name</i>)	Comments	Health Rating*	Structure Rating**	Remove/Preserve
53205	14	15	Douglas-fir (<i>Pseudotsuga menziesii</i>)	1-sided canopy (W)	1	2	Remove
53206	10	9	Douglas-fir (<i>Pseudotsuga menziesii</i>)		1	1	Remove
53207	14	10	Douglas-fir (<i>Pseudotsuga menziesii</i>)		1	1	Remove
53210	11	8	Douglas-fir (<i>Pseudotsuga menziesii</i>)		1	1	Remove
53211	14	12	Douglas-fir (<i>Pseudotsuga menziesii</i>)		1	1	Remove
53212	15	13	Douglas-fir (<i>Pseudotsuga menziesii</i>)		1	1	Remove
53213	13	11	Douglas-fir (<i>Pseudotsuga menziesii</i>)		1	1	Remove
53215	13	15	Douglas-fir (<i>Pseudotsuga menziesii</i>)		1	1	Remove
53216	13	10	Douglas-fir (<i>Pseudotsuga menziesii</i>)		1	1	Remove
53217	10	8	Douglas-fir (<i>Pseudotsuga menziesii</i>)		1	1	Remove
53218	10	8	Douglas-fir (<i>Pseudotsuga menziesii</i>)		1	1	Remove
53219	12	8	Douglas-fir (<i>Pseudotsuga menziesii</i>)		1	1	Remove
53220	8	5	Douglas-fir (<i>Pseudotsuga menziesii</i>)		1	1	Remove
53222	16	13	Douglas-fir (<i>Pseudotsuga menziesii</i>)	Crooked bole; 1-sided canopy (NW)	1	2	Remove
53223	10	6	Douglas-fir (<i>Pseudotsuga menziesii</i>)	Codominant top	1	2	Remove
53224	9,10	6	Douglas-fir (<i>Pseudotsuga menziesii</i>)	Codominant with included bark	1	2	Remove
53225	10	6	Douglas-fir (<i>Pseudotsuga menziesii</i>)		1	1	Remove
53226	17	8	Douglas-fir (<i>Pseudotsuga menziesii</i>)		1	1	Remove
53227	9	6	Douglas-fir (<i>Pseudotsuga menziesii</i>)	Codominant top	1	2	Remove
53228	15	10	Douglas-fir (<i>Pseudotsuga menziesii</i>)		1	1	Remove
53231	18	11	Douglas-fir (<i>Pseudotsuga menziesii</i>)		1	1	Remove
53232	21	18	Douglas-fir (<i>Pseudotsuga menziesii</i>)	Some broken branches	1	1	Remove
53234	15	17	Douglas-fir (<i>Pseudotsuga menziesii</i>)	1-sided canopy (E)	1	2	Remove
53235	14	10	Douglas-fir (<i>Pseudotsuga menziesii</i>)		1	1	Remove
53236	11	7	Douglas-fir (<i>Pseudotsuga menziesii</i>)		1	1	Remove
53237	12	10	Douglas-fir (<i>Pseudotsuga menziesii</i>)		1	1	Remove
53238	13	11	Douglas-fir (<i>Pseudotsuga menziesii</i>)		1	1	Remove
53240	17	17	Douglas-fir (<i>Pseudotsuga menziesii</i>)	Codominant with included bark	1	2	Remove
53241	12	11	Douglas-fir (<i>Pseudotsuga menziesii</i>)		1	1	Remove
53276	48	30	Douglas-fir (<i>Pseudotsuga menziesii</i>)	Codominant with included bark	1	2	Remove
53277	34	25	Douglas-fir (<i>Pseudotsuga menziesii</i>)	Codominant top with included bark	1	2	Remove
53280	8	13	Sweet Cherry (<i>Prunus avium</i>)		1	1	Preserve
53281	13	16	Douglas-fir (<i>Pseudotsuga menziesii</i>)		1	1	Preserve
53285	11	11	Douglas-fir (<i>Pseudotsuga menziesii</i>)		1	1	Preserve
53286	9	9	Douglas-fir (<i>Pseudotsuga menziesii</i>)	High canopy	1	2	Preserve
53290	12	10	Douglas-fir (<i>Pseudotsuga menziesii</i>)	High canopy	1	2	Preserve
53292	9	9	Douglas-fir (<i>Pseudotsuga menziesii</i>)	High canopy	1	2	Preserve
53293	10	10	Douglas-fir (<i>Pseudotsuga menziesii</i>)	High canopy	1	2	Preserve
53295	8	9	Douglas-fir (<i>Pseudotsuga menziesii</i>)	High canopy	1	2	Preserve
53296	10	9	Douglas-fir (<i>Pseudotsuga menziesii</i>)	High canopy	1	2	Remove
53297	9	9	Douglas-fir (<i>Pseudotsuga menziesii</i>)	1-sided canopy (S)	1	2	Remove
53298	10	9	Douglas-fir (<i>Pseudotsuga menziesii</i>)		1	1	Remove
53302	47	25	Douglas-fir (<i>Pseudotsuga menziesii</i>)	1-sided canopy (S)	1	2	Remove
53304	22	21	Douglas-fir (<i>Pseudotsuga menziesii</i>)	Lean (W); 1-sided canopy (W)	1	2	Remove
53306	34	19	Douglas-fir (<i>Pseudotsuga menziesii</i>)		1	1	Remove
53314	12	10	Douglas-fir (<i>Pseudotsuga menziesii</i>)		1	1	Remove
53315	8	9	Douglas-fir (<i>Pseudotsuga menziesii</i>)		1	1	Preserve
53317	8	7	Douglas-fir (<i>Pseudotsuga menziesii</i>)	High canopy	1	2	Preserve
53318	44	23	Douglas-fir (<i>Pseudotsuga menziesii</i>)		1	1	Remove
53321	9	7	Douglas-fir (<i>Pseudotsuga menziesii</i>)	High canopy	1	2	Preserve
53322	9	8	Douglas-fir (<i>Pseudotsuga menziesii</i>)	High canopy	1	2	Preserve
53323	10	8	Douglas-fir (<i>Pseudotsuga menziesii</i>)	High canopy	1	2	Preserve
53324	11	8	Douglas-fir (<i>Pseudotsuga menziesii</i>)		1	1	Preserve
53326	10	9	Douglas-fir (<i>Pseudotsuga menziesii</i>)		1	1	Preserve
53327	10	10	Douglas-fir (<i>Pseudotsuga menziesii</i>)	1-sided canopy (S)	1	2	Remove
53329	11	9	Douglas-fir (<i>Pseudotsuga menziesii</i>)	High canopy	1	2	Preserve
53330	9	10	Douglas-fir (<i>Pseudotsuga menziesii</i>)	1-sided canopy (S)	1	2	Preserve
53333	10	9	Douglas-fir (<i>Pseudotsuga menziesii</i>)	High canopy	1	2	Preserve
53337	34	26	Douglas-fir (<i>Pseudotsuga menziesii</i>)		1	1	Remove
53338	9	9	Douglas-fir (<i>Pseudotsuga menziesii</i>)	High canopy	1	2	Preserve
53339	12	12	Douglas-fir (<i>Pseudotsuga menziesii</i>)		1	1	Preserve
53341	13	12	Douglas-fir (<i>Pseudotsuga menziesii</i>)		1	1	Remove
53344	14	13	Douglas-fir (<i>Pseudotsuga menziesii</i>)		1	1	Remove
53345	8	10	Douglas-fir (<i>Pseudotsuga menziesii</i>)	1-sided canopy (S)	1	2	Remove
53346	10	11	Douglas-fir (<i>Pseudotsuga menziesii</i>)	1-sided canopy (S)	1	2	Remove
53348	8	9	Douglas-fir (<i>Pseudotsuga menziesii</i>)	High canopy	1	2	Remove
53350	12	11	Douglas-fir (<i>Pseudotsuga menziesii</i>)	1-sided canopy (S)	1	2	Remove
53351	8	10	Douglas-fir (<i>Pseudotsuga menziesii</i>)	High canopy; Sparse canopy	2	2	Remove
53356	8	10	Douglas-fir (<i>Pseudotsuga menziesii</i>)	High canopy	1	2	Remove

Detailed Tree Inventory for Autumn Sunrise

AKS Job No. 7454 - Evaluation Date: 2/1/2021 - 4/12/2021 - Evaluated by: BRK

Tree #	DBH (in.)	Avg. Crown Radius (ft)	Tree Species Common Name (<i>Scientific name</i>)	Comments	Health Rating*	Structure Rating**	Remove/Preserve
53359	12	10	Douglas-fir (<i>Pseudotsuga menziesii</i>)		1	1	Preserve
53361	8	7	Douglas-fir (<i>Pseudotsuga menziesii</i>)	High canopy; Sparse canopy	2	2	Preserve
53363	9	8	Douglas-fir (<i>Pseudotsuga menziesii</i>)		1	1	Preserve
53364	9	8	Douglas-fir (<i>Pseudotsuga menziesii</i>)		1	1	Preserve
53366	9	8	Douglas-fir (<i>Pseudotsuga menziesii</i>)		1	1	Preserve
53371	33	25	Bigleaf Maple (<i>Acer macrophyllum</i>)		1	1	Remove
53374	43	24	Douglas-fir (<i>Pseudotsuga menziesii</i>)		1	1	Remove
53381	13	10	Douglas-fir (<i>Pseudotsuga menziesii</i>)	1-sided canopy (S)	1	2	Remove
53382	10	8	Douglas-fir (<i>Pseudotsuga menziesii</i>)		1	1	Remove
53385	15	13	Douglas-fir (<i>Pseudotsuga menziesii</i>)		1	1	Remove
53386	12	10	Douglas-fir (<i>Pseudotsuga menziesii</i>)		1	1	Remove
53389	14	13	Douglas-fir (<i>Pseudotsuga menziesii</i>)	1-sided canopy (W)	1	2	Remove
53390	14	13	Douglas-fir (<i>Pseudotsuga menziesii</i>)		1	1	Remove
53391	14	12	Douglas-fir (<i>Pseudotsuga menziesii</i>)		1	1	Remove
53392	9	7	Douglas-fir (<i>Pseudotsuga menziesii</i>)	1-sided canopy (W)	1	2	Remove
53396	12	8	Douglas-fir (<i>Pseudotsuga menziesii</i>)		1	1	Remove
53399	23	18	Bigleaf Maple (<i>Acer macrophyllum</i>)	Dead tree with many epicormic stems	3	3	Remove
53414	38	21	Douglas-fir (<i>Pseudotsuga menziesii</i>)	1-sided canopy (W)	1	2	Remove
53415	34	21	Douglas-fir (<i>Pseudotsuga menziesii</i>)	Slight lean (E); 1-sided canopy (E); Over extended limbs; Broken branches with decay	2	2	Remove
53439	21	19	Douglas-fir (<i>Pseudotsuga menziesii</i>)	Codominant top	1	2	Remove
53556	22	17	Douglas-fir (<i>Pseudotsuga menziesii</i>)		1	1	Remove
53663	7	11	Pacific Madrone (<i>Arbutus menziesii</i>)	OFFSITE	1	1	Preserve
53724	14	8	Douglas-fir (<i>Pseudotsuga menziesii</i>)	Codominant top	1	2	Remove
53737	11	15	Douglas-fir (<i>Pseudotsuga menziesii</i>)	1-sided canopy (W)	1	2	Remove
53738	9	10	Douglas-fir (<i>Pseudotsuga menziesii</i>)		1	1	Remove
53739	12	10	Douglas-fir (<i>Pseudotsuga menziesii</i>)		1	1	Remove
53740	13	12	Douglas-fir (<i>Pseudotsuga menziesii</i>)	Bulges at base	2	1	Remove
53741	12	7	Douglas-fir (<i>Pseudotsuga menziesii</i>)		1	1	Remove
53742	14	10	Douglas-fir (<i>Pseudotsuga menziesii</i>)		1	1	Remove
53744	9	9	Douglas-fir (<i>Pseudotsuga menziesii</i>)		1	1	Remove
53745	8	6	Douglas-fir (<i>Pseudotsuga menziesii</i>)	Crooked bole	1	2	Remove
53746	14	10	Douglas-fir (<i>Pseudotsuga menziesii</i>)	Medium size cavity with decay	2	2	Remove
53747	8	9	Douglas-fir (<i>Pseudotsuga menziesii</i>)	1-sided canopy (W)	1	2	Remove
53749	13	8	Douglas-fir (<i>Pseudotsuga menziesii</i>)	Codominant top	1	2	Remove
53750	14	8	Douglas-fir (<i>Pseudotsuga menziesii</i>)		1	1	Remove
53751	12	15	Douglas-fir (<i>Pseudotsuga menziesii</i>)	1-sided canopy (E)	1	2	Remove
53753	14	9	Douglas-fir (<i>Pseudotsuga menziesii</i>)		1	1	Remove
53755	9	7	Douglas-fir (<i>Pseudotsuga menziesii</i>)	1-sided canopy (W)	1	2	Remove
53756	11	10	Douglas-fir (<i>Pseudotsuga menziesii</i>)	1-sided canopy (W)	1	2	Remove
53759	10	11	Douglas-fir (<i>Pseudotsuga menziesii</i>)		1	1	Remove
53760	12	10	Douglas-fir (<i>Pseudotsuga menziesii</i>)		1	1	Remove
53762	16	11	Douglas-fir (<i>Pseudotsuga menziesii</i>)		1	1	Remove
53765	12	12	Douglas-fir (<i>Pseudotsuga menziesii</i>)	1-sided canopy (E)	1	2	Remove
53770	10	10	Douglas-fir (<i>Pseudotsuga menziesii</i>)	1-sided canopy (S)	1	2	Remove
53771	8	7	Douglas-fir (<i>Pseudotsuga menziesii</i>)		1	1	Remove
53773	11	9	Douglas-fir (<i>Pseudotsuga menziesii</i>)		1	1	Remove
53777	27,25	22	Douglas-fir (<i>Pseudotsuga menziesii</i>)	Codominant base	1	2	Remove
53781	23	15	Douglas-fir (<i>Pseudotsuga menziesii</i>)		1	1	Remove
53782	17	18	Douglas-fir (<i>Pseudotsuga menziesii</i>)	Butt sweep; 1-sided canopy (N)	1	2	Remove
53786	35	20	Douglas-fir (<i>Pseudotsuga menziesii</i>)	Codominant base with included bark	1	2	Remove
53787	22	21	Douglas-fir (<i>Pseudotsuga menziesii</i>)	1-sided canopy (N)	1	2	Remove
53788	22	22	Douglas-fir (<i>Pseudotsuga menziesii</i>)	Deformed bole; Many weakly attached limbs; Some failed limbs	2	2	Remove
53793	8	7	Douglas-fir (<i>Pseudotsuga menziesii</i>)		1	1	Remove
53798	9	8	Douglas-fir (<i>Pseudotsuga menziesii</i>)		1	1	Remove
53802	12	16	Douglas-fir (<i>Pseudotsuga menziesii</i>)	1-sided canopy (E)	1	2	Remove
53803	9	4	Douglas-fir (<i>Pseudotsuga menziesii</i>)	High canopy	1	2	Remove
53809	9	6	Douglas-fir (<i>Pseudotsuga menziesii</i>)		1	1	Remove
53810	9	6	Douglas-fir (<i>Pseudotsuga menziesii</i>)	Broken top	2	3	Remove
53812	10	8	Douglas-fir (<i>Pseudotsuga menziesii</i>)		1	1	Remove
53813	9	6	Douglas-fir (<i>Pseudotsuga menziesii</i>)		1	1	Remove
53814	9	6	Douglas-fir (<i>Pseudotsuga menziesii</i>)		1	1	Remove
53817	29,30	18	Douglas-fir (<i>Pseudotsuga menziesii</i>)	Codominant base	1	2	Remove
53821	9	7	Douglas-fir (<i>Pseudotsuga menziesii</i>)		1	1	Remove
53822	10	10	Douglas-fir (<i>Pseudotsuga menziesii</i>)	1-sided canopy (S)	1	1	Remove
53823	10	9	Douglas-fir (<i>Pseudotsuga menziesii</i>)		1	1	Remove
53826	8	7	Douglas-fir (<i>Pseudotsuga menziesii</i>)		1	1	Remove
53827	10	8	Douglas-fir (<i>Pseudotsuga menziesii</i>)		1	1	Remove
53828	9	9	Douglas-fir (<i>Pseudotsuga menziesii</i>)		1	1	Remove

Detailed Tree Inventory for Autumn Sunrise

AKS Job No. 7454 - Evaluation Date: 2/1/2021 - 4/12/2021 - Evaluated by: BRK

Tree #	DBH (in.)	Avg. Crown Radius (ft)	Tree Species Common Name (<i>Scientific name</i>)	Comments	Health Rating*	Structure Rating**	Remove/Preserve
53829	9	6	Douglas-fir (<i>Pseudotsuga menziesii</i>)		1	1	Remove
53830	11	9	Douglas-fir (<i>Pseudotsuga menziesii</i>)	1-sided canopy (S)	1	2	Remove
53832	8	5	Douglas-fir (<i>Pseudotsuga menziesii</i>)		1	1	Remove
53835	9	6	Douglas-fir (<i>Pseudotsuga menziesii</i>)		1	1	Remove
53836	9	6	Douglas-fir (<i>Pseudotsuga menziesii</i>)		1	1	Remove
53840	10	7	Douglas-fir (<i>Pseudotsuga menziesii</i>)		1	1	Remove
53846	8	6	Douglas-fir (<i>Pseudotsuga menziesii</i>)	Broken top; Sparse canopy	2	3	Remove
53847	9	9	Douglas-fir (<i>Pseudotsuga menziesii</i>)		1	1	Remove
53848	11	9	Douglas-fir (<i>Pseudotsuga menziesii</i>)		1	1	Remove
53859	8	0	Douglas-fir (<i>Pseudotsuga menziesii</i>)	Dead; broken at 30'	3	3	Remove
53862	9	5	Douglas-fir (<i>Pseudotsuga menziesii</i>)	High canopy	1	2	Remove
53864	9	7	Douglas-fir (<i>Pseudotsuga menziesii</i>)		1	1	Remove
53865	9	0	Douglas-fir (<i>Pseudotsuga menziesii</i>)	Dead; Broken at 40'	3	3	Remove
53870	8	5	Douglas-fir (<i>Pseudotsuga menziesii</i>)	High canopy	1	2	Remove
53891	11	15	Douglas-fir (<i>Pseudotsuga menziesii</i>)	1-sided canopy (W)	1	2	Remove
60000	29	19	Douglas-fir (<i>Pseudotsuga menziesii</i>)		1	1	Remove
60007	14	17	Douglas-fir (<i>Pseudotsuga menziesii</i>)	1-sided canopy (S)	1	2	Remove
60008	16	18	Douglas-fir (<i>Pseudotsuga menziesii</i>)	1-sided canopy (S)	1	2	Remove
60009	18	11	Douglas-fir (<i>Pseudotsuga menziesii</i>)	Sweep	1	2	Remove
60011	24	13	Douglas-fir (<i>Pseudotsuga menziesii</i>)		1	1	Remove
60012	10	6	Douglas-fir (<i>Pseudotsuga menziesii</i>)		1	1	Remove
60013	9	6	Douglas-fir (<i>Pseudotsuga menziesii</i>)		1	1	Remove
60014	22	22	Douglas-fir (<i>Pseudotsuga menziesii</i>)	1-sided canopy (W); Deformed bole; Bore holes; Broken limbs	2	2	Remove
60015	11	8	Douglas-fir (<i>Pseudotsuga menziesii</i>)		1	1	Remove
60016	11	6	Douglas-fir (<i>Pseudotsuga menziesii</i>)		1	1	Remove
60017	11	6	Douglas-fir (<i>Pseudotsuga menziesii</i>)		1	1	Remove
60018	8	4	Douglas-fir (<i>Pseudotsuga menziesii</i>)	High canopy	1	2	Remove
60020	10	5	Douglas-fir (<i>Pseudotsuga menziesii</i>)		1	1	Remove
60021	11	9	Douglas-fir (<i>Pseudotsuga menziesii</i>)		1	1	Remove
60022	11	9	Douglas-fir (<i>Pseudotsuga menziesii</i>)		1	1	Remove
60023	11	7	Douglas-fir (<i>Pseudotsuga menziesii</i>)		1	1	Remove
60024	11	11	Douglas-fir (<i>Pseudotsuga menziesii</i>)		1	1	Remove
60025	8	0	Douglas-fir (<i>Pseudotsuga menziesii</i>)	Dead	3	3	Remove
60026	10	7	Douglas-fir (<i>Pseudotsuga menziesii</i>)		1	1	Remove
60027	15	13	Douglas-fir (<i>Pseudotsuga menziesii</i>)		1	1	Remove
60028	12	11	Douglas-fir (<i>Pseudotsuga menziesii</i>)		1	1	Remove
60029	9	7	Douglas-fir (<i>Pseudotsuga menziesii</i>)	High canopy	1	2	Remove
60030	14	9	Douglas-fir (<i>Pseudotsuga menziesii</i>)		1	1	Remove
60031	9	7	Douglas-fir (<i>Pseudotsuga menziesii</i>)		1	1	Remove
60032	14	14	Douglas-fir (<i>Pseudotsuga menziesii</i>)	1-sided canopy (N)	1	2	Remove
60033	14	15	Douglas-fir (<i>Pseudotsuga menziesii</i>)	1-sided canopy (N)	1	2	Remove
60034	12	13	Douglas-fir (<i>Pseudotsuga menziesii</i>)		1	1	Remove
60035	11	11	Douglas-fir (<i>Pseudotsuga menziesii</i>)		1	1	Remove
60037	9	4	Douglas-fir (<i>Pseudotsuga menziesii</i>)	High canopy	1	2	Remove
60038	11	8	Douglas-fir (<i>Pseudotsuga menziesii</i>)		1	1	Remove
60039	9	9	Douglas-fir (<i>Pseudotsuga menziesii</i>)		1	1	Remove
60040	9	7	Douglas-fir (<i>Pseudotsuga menziesii</i>)		1	1	Remove
60041	12	8	Douglas-fir (<i>Pseudotsuga menziesii</i>)		1	1	Remove
60042	11	11	Douglas-fir (<i>Pseudotsuga menziesii</i>)		1	1	Remove
60043	12	8	Douglas-fir (<i>Pseudotsuga menziesii</i>)		1	1	Remove
60044	12	10	Douglas-fir (<i>Pseudotsuga menziesii</i>)		1	1	Remove
60045	8,8	7	Douglas-fir (<i>Pseudotsuga menziesii</i>)	Codominant base with included bark	1	2	Remove
60046	10	11	Douglas-fir (<i>Pseudotsuga menziesii</i>)		1	1	Remove
60047	14	8	Douglas-fir (<i>Pseudotsuga menziesii</i>)	Deformed bole	1	2	Remove
60048	16	18	Douglas-fir (<i>Pseudotsuga menziesii</i>)	1-sided canopy (N)	1	2	Remove
60049	12	12	Douglas-fir (<i>Pseudotsuga menziesii</i>)	Codominant top	1	2	Remove
60050	8	10	Douglas-fir (<i>Pseudotsuga menziesii</i>)	High canopy	1	2	Remove
60051	9	9	Douglas-fir (<i>Pseudotsuga menziesii</i>)	Mechanical damage with seepage	2	1	Remove
60052	11	10	Douglas-fir (<i>Pseudotsuga menziesii</i>)		1	1	Remove
60053	12	12	Douglas-fir (<i>Pseudotsuga menziesii</i>)	High canopy	1	2	Remove
60054	8	8	Douglas-fir (<i>Pseudotsuga menziesii</i>)	Crooked bole; High canopy; 1-sided canopy (E)	1	2	Remove
60055	13	13	Douglas-fir (<i>Pseudotsuga menziesii</i>)		1	1	Remove
60075	50	25	Douglas-fir (<i>Pseudotsuga menziesii</i>)		1	1	Remove
60077	19	15	Douglas-fir (<i>Pseudotsuga menziesii</i>)	OFFSITE; Evaluated from property line	1	1	Remove
60085	11	8	Douglas-fir (<i>Pseudotsuga menziesii</i>)	1-sided canopy (W)	1	2	Remove
60086	9	7	Douglas-fir (<i>Pseudotsuga menziesii</i>)	High canopy	1	2	Remove
60088	10	9	Douglas-fir (<i>Pseudotsuga menziesii</i>)	1-sided canopy (S)	1	2	Remove
60089	13	5	Douglas-fir (<i>Pseudotsuga menziesii</i>)	High canopy	1	2	Remove

Detailed Tree Inventory for Autumn Sunrise

AKS Job No. 7454 - Evaluation Date: 2/1/2021 - 4/12/2021 - Evaluated by: BRK

Tree #	DBH (in.)	Avg. Crown Radius (ft)	Tree Species Common Name (Scientific name)	Comments	Health Rating*	Structure Rating**	Remove/Preserve
60090	12,7	0	Douglas-fir (<i>Pseudotsuga menziesii</i>)	Codominant base; Dead and broken top	2	3	Remove
60091	17	6	Douglas-fir (<i>Pseudotsuga menziesii</i>)		1	1	Remove
60092	9	0	Douglas-fir (<i>Pseudotsuga menziesii</i>)	Dead	3	3	Remove
60093	14	8	Douglas-fir (<i>Pseudotsuga menziesii</i>)		1	1	Remove
60094	11	9	Douglas-fir (<i>Pseudotsuga menziesii</i>)		1	1	Remove
60095	10	6	Douglas-fir (<i>Pseudotsuga menziesii</i>)	Very top broken	2	2	Remove
60096	11	6	Douglas-fir (<i>Pseudotsuga menziesii</i>)		1	1	Remove
60097	13	7	Douglas-fir (<i>Pseudotsuga menziesii</i>)		1	1	Remove
60098	10	7	Douglas-fir (<i>Pseudotsuga menziesii</i>)		1	1	Remove
60099	13	8	Douglas-fir (<i>Pseudotsuga menziesii</i>)		1	1	Remove
60100	12	7	Douglas-fir (<i>Pseudotsuga menziesii</i>)		1	1	Remove
60101	13	10	Douglas-fir (<i>Pseudotsuga menziesii</i>)	High canopy	1	2	Remove
60102	13	7	Douglas-fir (<i>Pseudotsuga menziesii</i>)		1	1	Remove
60103	13,10	8	Douglas-fir (<i>Pseudotsuga menziesii</i>)	Codominant base with included bark	1	2	Remove
60104	12	15	Douglas-fir (<i>Pseudotsuga menziesii</i>)	1-sided canopy (E)	1	2	Remove
60105	14	9	Douglas-fir (<i>Pseudotsuga menziesii</i>)		1	1	Remove
60106	12	6	Douglas-fir (<i>Pseudotsuga menziesii</i>)		1	1	Remove
60107	14	10	Douglas-fir (<i>Pseudotsuga menziesii</i>)	Codominant top	1	2	Remove
60108	18	11	Douglas-fir (<i>Pseudotsuga menziesii</i>)		1	1	Remove
60109	8	0	Douglas-fir (<i>Pseudotsuga menziesii</i>)	Dead	3	3	Remove
60110	11	7	Douglas-fir (<i>Pseudotsuga menziesii</i>)		1	1	Remove
60111	13	8	Douglas-fir (<i>Pseudotsuga menziesii</i>)		1	1	Remove
60112	13	7	Douglas-fir (<i>Pseudotsuga menziesii</i>)		1	1	Remove
60113	11	5	Douglas-fir (<i>Pseudotsuga menziesii</i>)	High canopy	1	2	Remove
60114	10	11	Cherry (<i>Prunus sp.</i>)	Codominant with included bark	1	2	Remove
60115	14	8	Douglas-fir (<i>Pseudotsuga menziesii</i>)		1	1	Remove
60116	10	5	Douglas-fir (<i>Pseudotsuga menziesii</i>)	High canopy	1	2	Remove
60118	11	7	Douglas-fir (<i>Pseudotsuga menziesii</i>)		1	1	Remove
60119	11	8	Douglas-fir (<i>Pseudotsuga menziesii</i>)		1	1	Remove
60120	18	9	Douglas-fir (<i>Pseudotsuga menziesii</i>)		1	1	Remove
60121	11	7	Douglas-fir (<i>Pseudotsuga menziesii</i>)	1-sided canopy (S)	1	2	Remove
60122	35	20	Douglas-fir (<i>Pseudotsuga menziesii</i>)		1	1	Remove
60123	13	7	Douglas-fir (<i>Pseudotsuga menziesii</i>)		1	1	Remove
60124	14	13	Douglas-fir (<i>Pseudotsuga menziesii</i>)	Sweep	1	2	Remove
60125	18	14	Douglas-fir (<i>Pseudotsuga menziesii</i>)		1	1	Remove
60126	10	11	Douglas-fir (<i>Pseudotsuga menziesii</i>)	High canopy; 1-sided canopy (N)	1	2	Remove
60127	11	8	Douglas-fir (<i>Pseudotsuga menziesii</i>)		1	1	Remove
60128	19	12	Douglas-fir (<i>Pseudotsuga menziesii</i>)		1	1	Remove
60129	14	9	Douglas-fir (<i>Pseudotsuga menziesii</i>)		1	1	Remove
60131	9	4	Douglas-fir (<i>Pseudotsuga menziesii</i>)	High canopy	1	2	Remove
60132	13	0	Douglas-fir (<i>Pseudotsuga menziesii</i>)	Dead; Broken at 30'	3	3	Remove
60133	8	3	Douglas-fir (<i>Pseudotsuga menziesii</i>)	High canopy	1	2	Remove
60134	11	5	Douglas-fir (<i>Pseudotsuga menziesii</i>)	High canopy	1	2	Remove
60135	9	6	Douglas-fir (<i>Pseudotsuga menziesii</i>)	High canopy	1	2	Remove
60136	11	0	Douglas-fir (<i>Pseudotsuga menziesii</i>)	Dead	3	3	Remove
60137	8	12	Douglas-fir (<i>Pseudotsuga menziesii</i>)	1-sided canopy (W)	1	2	Remove
60139	8	7	Douglas-fir (<i>Pseudotsuga menziesii</i>)	1-sided canopy (W); High canopy	1	2	Remove
60140	34	12	Douglas-fir (<i>Pseudotsuga menziesii</i>)	LINE TREE; Evaluated from property line; Dead limbs; Epicormic sprouts	2	1	Remove
60145	20	15	Douglas-fir (<i>Pseudotsuga menziesii</i>)	Broken top with 2 large leaders	2	3	Remove
60146	13	10	Douglas-fir (<i>Pseudotsuga menziesii</i>)		1	1	Remove
60147	18	15	Douglas-fir (<i>Pseudotsuga menziesii</i>)	Crooked bole; Codominant top	1	2	Remove
60148	8	5	Douglas-fir (<i>Pseudotsuga menziesii</i>)	1-sided canopy (W)	1	2	Remove
60149	19	17	Douglas-fir (<i>Pseudotsuga menziesii</i>)	1-sided canopy (W)	1	2	Remove
60150	12,7	15	Douglas-fir (<i>Pseudotsuga menziesii</i>)	1-sided canopy (N)	1	2	Remove
60151	8	5	Douglas-fir (<i>Pseudotsuga menziesii</i>)	Sweep; High canopy	1	2	Remove
60153	11	11	Douglas-fir (<i>Pseudotsuga menziesii</i>)		1	1	Remove
60154	9	0	Douglas-fir (<i>Pseudotsuga menziesii</i>)	Dead	3	3	Remove
60155	11	5	Douglas-fir (<i>Pseudotsuga menziesii</i>)	High canopy	1	2	Remove
60156	17	14	Douglas-fir (<i>Pseudotsuga menziesii</i>)		1	1	Remove
60157	8	10	Douglas-fir (<i>Pseudotsuga menziesii</i>)	1-sided canopy (N)	1	2	Remove
60159	9	6	Douglas-fir (<i>Pseudotsuga menziesii</i>)		1	1	Remove
60160	9	5	Douglas-fir (<i>Pseudotsuga menziesii</i>)		1	1	Remove
60161	12	9	Douglas-fir (<i>Pseudotsuga menziesii</i>)		1	1	Remove
60162	12	7	Douglas-fir (<i>Pseudotsuga menziesii</i>)		1	1	Remove
60163	15	8	Douglas-fir (<i>Pseudotsuga menziesii</i>)		1	1	Remove
60164	10,11	6	Douglas-fir (<i>Pseudotsuga menziesii</i>)	Codominant base with included bark	1	2	Remove
60165	8	3	Douglas-fir (<i>Pseudotsuga menziesii</i>)	High canopy; Suppressed	2	2	Remove
60166	16	9	Douglas-fir (<i>Pseudotsuga menziesii</i>)		1	1	Remove

Detailed Tree Inventory for Autumn Sunrise

AKS Job No. 7454 - Evaluation Date: 2/1/2021 - 4/12/2021 - Evaluated by: BRK

Tree #	DBH (in.)	Avg. Crown Radius (ft)	Tree Species Common Name (<i>Scientific name</i>)	Comments	Health Rating*	Structure Rating**	Remove/Preserve
60167	12	8	Douglas-fir (<i>Pseudotsuga menziesii</i>)		1	1	Remove
60168	8	5	Douglas-fir (<i>Pseudotsuga menziesii</i>)	High canopy	1	2	Remove
60169	15	17	Douglas-fir (<i>Pseudotsuga menziesii</i>)	Broken branches; 1-sided canopy (W)	1	2	Remove
60170	10,7	7	Douglas-fir (<i>Pseudotsuga menziesii</i>)	Codominant base	1	2	Remove
60171	9	3	Douglas-fir (<i>Pseudotsuga menziesii</i>)	High canopy	1	2	Remove
60172	9	5	Douglas-fir (<i>Pseudotsuga menziesii</i>)		1	1	Remove
60173	13	8	Douglas-fir (<i>Pseudotsuga menziesii</i>)		1	1	Remove
60174	15	13	Douglas-fir (<i>Pseudotsuga menziesii</i>)		1	1	Remove
60175	12	6	Douglas-fir (<i>Pseudotsuga menziesii</i>)		1	1	Remove
60176	10	6	Douglas-fir (<i>Pseudotsuga menziesii</i>)	High canopy	1	2	Remove
60178	10	3	Douglas-fir (<i>Pseudotsuga menziesii</i>)	High canopy	1	2	Remove
60179	10	5	Douglas-fir (<i>Pseudotsuga menziesii</i>)		1	1	Remove
60180	12	5	Douglas-fir (<i>Pseudotsuga menziesii</i>)	High canopy	1	2	Remove
60181	13	7	Douglas-fir (<i>Pseudotsuga menziesii</i>)		1	1	Remove
60182	13	9	Douglas-fir (<i>Pseudotsuga menziesii</i>)		1	1	Remove
60183	13	8	Douglas-fir (<i>Pseudotsuga menziesii</i>)		1	1	Remove
60184	15	8	Douglas-fir (<i>Pseudotsuga menziesii</i>)		1	1	Remove
60185	12	8	Douglas-fir (<i>Pseudotsuga menziesii</i>)	Crooked bole	1	2	Remove
60186	15	8	Douglas-fir (<i>Pseudotsuga menziesii</i>)		1	1	Remove
60187	13	7	Douglas-fir (<i>Pseudotsuga menziesii</i>)		1	1	Remove
60188	8	4	Douglas-fir (<i>Pseudotsuga menziesii</i>)	High canopy	1	2	Remove
60189	11	7	Douglas-fir (<i>Pseudotsuga menziesii</i>)		1	1	Remove
60190	9	3	Douglas-fir (<i>Pseudotsuga menziesii</i>)	High canopy	1	2	Remove
60191	13	7	Douglas-fir (<i>Pseudotsuga menziesii</i>)		1	1	Remove
60192	10	6	Douglas-fir (<i>Pseudotsuga menziesii</i>)		1	1	Remove
60193	13	7	Douglas-fir (<i>Pseudotsuga menziesii</i>)		1	1	Remove
60195	12	8	Douglas-fir (<i>Pseudotsuga menziesii</i>)		1	1	Remove
60196	11	6	Douglas-fir (<i>Pseudotsuga menziesii</i>)		1	1	Remove
60197	8	9	Douglas-fir (<i>Pseudotsuga menziesii</i>)	Broken top	2	3	Remove
60198	11	6	Douglas-fir (<i>Pseudotsuga menziesii</i>)		1	1	Remove
60200	11	9	Douglas-fir (<i>Pseudotsuga menziesii</i>)		1	1	Remove
60201	14	10	Douglas-fir (<i>Pseudotsuga menziesii</i>)		1	1	Remove
60203	12	9	Douglas-fir (<i>Pseudotsuga menziesii</i>)		1	1	Remove
60204	15	9	Douglas-fir (<i>Pseudotsuga menziesii</i>)		1	1	Remove
60206	11	6	Douglas-fir (<i>Pseudotsuga menziesii</i>)		1	1	Remove
60207	12	7	Douglas-fir (<i>Pseudotsuga menziesii</i>)		1	1	Remove
60209	10	5	Douglas-fir (<i>Pseudotsuga menziesii</i>)		1	1	Remove
60212	9	6	Douglas-fir (<i>Pseudotsuga menziesii</i>)		1	1	Remove
60214	10	14	Pacific Yew (<i>Taxus brevifolia</i>)	Dead branches; Sparse canopy; 1-sided canopy (N)	2	2	Remove
60215	8	0	Pacific Yew (<i>Taxus brevifolia</i>)	Dead; Broken at 30'	3	3	Remove
60216	43	18	Douglas-fir (<i>Pseudotsuga menziesii</i>)		1	1	Remove
60218	10	8	Douglas-fir (<i>Pseudotsuga menziesii</i>)		1	1	Remove
60220	40	15	Douglas-fir (<i>Pseudotsuga menziesii</i>)	OFFSITE; Evaluated behind fence	1	1	Remove
60223	36	20	Douglas-fir (<i>Pseudotsuga menziesii</i>)	OFFSITE; Evaluated behind fence	1	1	Remove
60229	19	16	Douglas-fir (<i>Pseudotsuga menziesii</i>)		1	1	Remove
60230	21	9	Douglas-fir (<i>Pseudotsuga menziesii</i>)		1	1	Remove
60231	22	12	Douglas-fir (<i>Pseudotsuga menziesii</i>)		1	1	Remove
60232	10	6	Douglas-fir (<i>Pseudotsuga menziesii</i>)		1	1	Remove
60233	8	0	Douglas-fir (<i>Pseudotsuga menziesii</i>)	Dead	3	3	Remove
60234	12	7	Douglas-fir (<i>Pseudotsuga menziesii</i>)		1	1	Remove
60235	20	9	Douglas-fir (<i>Pseudotsuga menziesii</i>)		1	1	Remove
60236	23	15	Douglas-fir (<i>Pseudotsuga menziesii</i>)		1	1	Remove
60237	10	10	Douglas-fir (<i>Pseudotsuga menziesii</i>)		1	1	Remove
60238	13	9	Douglas-fir (<i>Pseudotsuga menziesii</i>)		1	1	Remove
60239	11	7	Douglas-fir (<i>Pseudotsuga menziesii</i>)		1	1	Remove
60240	10	6	Douglas-fir (<i>Pseudotsuga menziesii</i>)		1	1	Remove
60241	14	8	Douglas-fir (<i>Pseudotsuga menziesii</i>)		1	1	Remove
60242	13	7	Douglas-fir (<i>Pseudotsuga menziesii</i>)		1	1	Remove
60243	14	6	Douglas-fir (<i>Pseudotsuga menziesii</i>)	High canopy	1	2	Remove
60244	13	6	Douglas-fir (<i>Pseudotsuga menziesii</i>)		1	1	Remove
60245	13	10	Douglas-fir (<i>Pseudotsuga menziesii</i>)		1	1	Remove
65000	19	19	Bigleaf Maple (<i>Acer macrophyllum</i>)	Broken stems; 75% ivy coverage; Sparse canopy	2	2	Remove
65001	15	7	Bigleaf Maple (<i>Acer macrophyllum</i>)	100% ivy coverage; Sparse canopy; High canopy	2	2	Remove
65002	23	17	Bigleaf Maple (<i>Acer macrophyllum</i>)		1	1	Remove
65003	15	20	Bigleaf Maple (<i>Acer macrophyllum</i>)	Lean (W); 1-sided canopy (W)	1	2	Remove
65005	22	14	Douglas-fir (<i>Pseudotsuga menziesii</i>)	Deformed bole	1	2	Remove
65007	19,18	19	Bigleaf Maple (<i>Acer macrophyllum</i>)	Codominant base with included bark	1	2	Remove
65008	23	14	Douglas-fir (<i>Pseudotsuga menziesii</i>)		1	1	Remove
65009	14	23	Pacific Madrone (<i>Arbutus menziesii</i>)	Lean (W); Dead limbs	2	2	Remove

Detailed Tree Inventory for Autumn Sunrise

AKS Job No. 7454 - Evaluation Date: 2/1/2021 - 4/12/2021 - Evaluated by: BRK

Tree #	DBH (in.)	Avg. Crown Radius (ft)	Tree Species Common Name (<i>Scientific name</i>)	Comments	Health Rating*	Structure Rating**	Remove/Preserve
65010	21	0	Bigleaf Maple (<i>Acer macrophyllum</i>)	Dead; Broken at 20'	3	3	Remove
65011	24	19	Bigleaf Maple (<i>Acer macrophyllum</i>)	Broken Codominant stem; 1-sided canopy (N)	2	2	Remove
65012	13,18	20	Bigleaf Maple (<i>Acer macrophyllum</i>)	Broken stems; Lean (W); 1-sided canopy (W)	1	2	Remove
65014	13	4	Douglas-fir (<i>Pseudotsuga menziesii</i>)	Epicormic sprouts; Very sparse canopy	3	2	Remove
65015	8	0	Bigleaf Maple (<i>Acer macrophyllum</i>)	Dead	3	3	Remove
65016	12	12	Bigleaf Maple (<i>Acer macrophyllum</i>)	High canopy; Sparse canopy	2	2	Remove
65018	22	18	Bigleaf Maple (<i>Acer macrophyllum</i>)		1	1	Remove
65023	9	7	Douglas-fir (<i>Pseudotsuga menziesii</i>)		1	1	Remove
65024	9	8	Douglas-fir (<i>Pseudotsuga menziesii</i>)	Lean (W); Uprooting	2	3	Remove
65025	9	7	Douglas-fir (<i>Pseudotsuga menziesii</i>)		1	1	Remove
65028	10	9	Douglas-fir (<i>Pseudotsuga menziesii</i>)		1	1	Remove
65030	9	7	Douglas-fir (<i>Pseudotsuga menziesii</i>)		1	1	Remove
65031	10	8	Douglas-fir (<i>Pseudotsuga menziesii</i>)		1	1	Remove
65032	8	10	Douglas-fir (<i>Pseudotsuga menziesii</i>)		1	1	Remove
65033	13	6	Douglas-fir (<i>Pseudotsuga menziesii</i>)		1	1	Remove
65036	11	10	Douglas-fir (<i>Pseudotsuga menziesii</i>)		1	1	Remove
65037	8	7	Douglas-fir (<i>Pseudotsuga menziesii</i>)		1	1	Remove
65038	10	7	Douglas-fir (<i>Pseudotsuga menziesii</i>)		1	1	Remove
65044	10	7	Douglas-fir (<i>Pseudotsuga menziesii</i>)		1	1	Remove
65045	11	9	Douglas-fir (<i>Pseudotsuga menziesii</i>)		1	1	Remove
65046	10	7	Douglas-fir (<i>Pseudotsuga menziesii</i>)		1	1	Remove
65047	10	8	Douglas-fir (<i>Pseudotsuga menziesii</i>)	1-sided canopy (W)	1	2	Remove
65048	11	9	Douglas-fir (<i>Pseudotsuga menziesii</i>)		1	1	Remove
65049	11	5	Douglas-fir (<i>Pseudotsuga menziesii</i>)		1	1	Remove
65050	9	7	Douglas-fir (<i>Pseudotsuga menziesii</i>)		1	1	Remove
65051	8	7	Douglas-fir (<i>Pseudotsuga menziesii</i>)		1	1	Remove
65052	11	9	Douglas-fir (<i>Pseudotsuga menziesii</i>)		1	1	Remove
65053	9	10	Douglas-fir (<i>Pseudotsuga menziesii</i>)		1	1	Remove
65054	11	8	Douglas-fir (<i>Pseudotsuga menziesii</i>)		1	1	Remove
65055	9	7	Douglas-fir (<i>Pseudotsuga menziesii</i>)		1	1	Remove
65056	13	10	Douglas-fir (<i>Pseudotsuga menziesii</i>)		1	1	Remove
65057	13	11	Douglas-fir (<i>Pseudotsuga menziesii</i>)		1	1	Remove
65058	11	9	Douglas-fir (<i>Pseudotsuga menziesii</i>)		1	1	Remove
65059	10	10	Douglas-fir (<i>Pseudotsuga menziesii</i>)	1-sided canopy (W)	1	2	Remove
65060	9	6	Douglas-fir (<i>Pseudotsuga menziesii</i>)		1	1	Remove
65061	10	6	Douglas-fir (<i>Pseudotsuga menziesii</i>)		1	1	Remove
65062	10	4	Douglas-fir (<i>Pseudotsuga menziesii</i>)	Broken top	2	3	Remove
65063	10	7	Douglas-fir (<i>Pseudotsuga menziesii</i>)	Broken top; Sparse canopy	2	3	Remove
65064	9	5	Douglas-fir (<i>Pseudotsuga menziesii</i>)	High canopy	1	2	Remove
65065	9	7	Douglas-fir (<i>Pseudotsuga menziesii</i>)		1	1	Remove
65066	11	8	Douglas-fir (<i>Pseudotsuga menziesii</i>)		1	1	Remove
65067	11	8	Douglas-fir (<i>Pseudotsuga menziesii</i>)		1	1	Remove
65068	11	7	Douglas-fir (<i>Pseudotsuga menziesii</i>)		1	1	Remove
65069	11	7	Douglas-fir (<i>Pseudotsuga menziesii</i>)		1	1	Remove
65070	12	5	Douglas-fir (<i>Pseudotsuga menziesii</i>)	Broken top; Sparse canopy	2	3	Remove
65071	12	15	Douglas-fir (<i>Pseudotsuga menziesii</i>)		1	1	Remove
65072	12	11	Douglas-fir (<i>Pseudotsuga menziesii</i>)		1	1	Remove
65073	9	7	Douglas-fir (<i>Pseudotsuga menziesii</i>)		1	1	Remove
65074	9	8	Douglas-fir (<i>Pseudotsuga menziesii</i>)		1	1	Remove
65076	10	7	Douglas-fir (<i>Pseudotsuga menziesii</i>)		1	1	Remove
65077	12	4	Douglas-fir (<i>Pseudotsuga menziesii</i>)	High canopy	1	2	Remove
65078	8	6	Douglas-fir (<i>Pseudotsuga menziesii</i>)		1	1	Remove
65079	10	6	Douglas-fir (<i>Pseudotsuga menziesii</i>)		1	1	Remove
65080	9	6	Douglas-fir (<i>Pseudotsuga menziesii</i>)		1	1	Remove
65082	21	20	Bigleaf Maple (<i>Acer macrophyllum</i>)	1-sided canopy (N)	1	2	Remove
65083	16,24	25	Bigleaf Maple (<i>Acer macrophyllum</i>)	1-sided canopy (S)	1	2	Remove
65088	42	26	Douglas-fir (<i>Pseudotsuga menziesii</i>)		1	1	Remove
65089	9	10	Douglas-fir (<i>Pseudotsuga menziesii</i>)		1	1	Preserve
65091	8	8	Douglas-fir (<i>Pseudotsuga menziesii</i>)		1	1	Preserve
65094	10	9	Douglas-fir (<i>Pseudotsuga menziesii</i>)		1	1	Preserve
65096	8	9	Douglas-fir (<i>Pseudotsuga menziesii</i>)		1	1	Remove
65098	8	7	Douglas-fir (<i>Pseudotsuga menziesii</i>)	High canopy	1	2	Remove
65099	8	8	Douglas-fir (<i>Pseudotsuga menziesii</i>)		1	1	Remove
65103	8	8	Douglas-fir (<i>Pseudotsuga menziesii</i>)	Broken top; Sparse canopy	2	3	Remove
65105	9	11	Douglas-fir (<i>Pseudotsuga menziesii</i>)		1	1	Remove
65106	9	11	Douglas-fir (<i>Pseudotsuga menziesii</i>)		1	1	Remove
65107	11	11	Douglas-fir (<i>Pseudotsuga menziesii</i>)		1	1	Preserve
65108	12	10	Douglas-fir (<i>Pseudotsuga menziesii</i>)	Crooked top; 1-sided canopy (S)	1	2	Preserve
65110	8	7	Douglas-fir (<i>Pseudotsuga menziesii</i>)		1	1	Preserve

Detailed Tree Inventory for Autumn Sunrise

AKS Job No. 7454 - Evaluation Date: 2/1/2021 - 4/12/2021 - Evaluated by: BRK

Tree #	DBH (in.)	Avg. Crown Radius (ft)	Tree Species Common Name (<i>Scientific name</i>)	Comments	Health Rating*	Structure Rating**	Remove/Preserve
65111	27	21	Douglas-fir (<i>Pseudotsuga menziesii</i>)		1	1	Remove
65112	8	9	Douglas-fir (<i>Pseudotsuga menziesii</i>)	1-sided canopy (S)	1	2	Preserve
65113	51	35	Bigleaf Maple (<i>Acer macrophyllum</i>)	Broken codominant stem at base leaving cavity with decay; Broken scaffold branches	2	2	Remove
65115	33	23	Douglas-fir (<i>Pseudotsuga menziesii</i>)		1	1	Preserve
65118	10	6	Douglas-fir (<i>Pseudotsuga menziesii</i>)		1	1	Remove
65119	8	6	Douglas-fir (<i>Pseudotsuga menziesii</i>)		1	1	Remove
65120	8	6	Douglas-fir (<i>Pseudotsuga menziesii</i>)		1	1	Remove
65121	10	9	Douglas-fir (<i>Pseudotsuga menziesii</i>)	1-sided canopy (W)	1	2	Remove
65123	8	10	Douglas-fir (<i>Pseudotsuga menziesii</i>)	1-sided canopy (W)	1	2	Remove
65124	8	8	Douglas-fir (<i>Pseudotsuga menziesii</i>)	High canopy	1	2	Remove
65125	8	10	Douglas-fir (<i>Pseudotsuga menziesii</i>)		1	1	Remove
65126	8	6	Douglas-fir (<i>Pseudotsuga menziesii</i>)	High canopy	1	2	Remove
65128	10	7	Douglas-fir (<i>Pseudotsuga menziesii</i>)	1-sided canopy (W)	1	2	Remove
65129	8	7	Douglas-fir (<i>Pseudotsuga menziesii</i>)		1	1	Remove
65131	8	6	Douglas-fir (<i>Pseudotsuga menziesii</i>)	High canopy; 1-sided canopy (W)	1	2	Remove
65133	9	9	Douglas-fir (<i>Pseudotsuga menziesii</i>)		1	1	Remove
65140	11	11	Douglas-fir (<i>Pseudotsuga menziesii</i>)	1-sided canopy (W)	1	2	Remove
65141	12	8	Douglas-fir (<i>Pseudotsuga menziesii</i>)		1	1	Remove
65142	11	9	Douglas-fir (<i>Pseudotsuga menziesii</i>)	1-sided canopy (W)	1	2	Remove
65143	10	7	Douglas-fir (<i>Pseudotsuga menziesii</i>)	1-sided canopy (W)	1	2	Remove
65144	11	8	Douglas-fir (<i>Pseudotsuga menziesii</i>)		1	1	Remove
65145	10	9	Douglas-fir (<i>Pseudotsuga menziesii</i>)		1	1	Remove
65146	10	7	Douglas-fir (<i>Pseudotsuga menziesii</i>)		1	1	Remove
65147	10	6	Douglas-fir (<i>Pseudotsuga menziesii</i>)	Codominant top	1	2	Remove
65148	9	8	Douglas-fir (<i>Pseudotsuga menziesii</i>)	1-sided canopy (E)	1	2	Remove
65149	11	6	Douglas-fir (<i>Pseudotsuga menziesii</i>)		1	1	Remove
65150	9	7	Douglas-fir (<i>Pseudotsuga menziesii</i>)		1	1	Remove
65151	12	9	Douglas-fir (<i>Pseudotsuga menziesii</i>)		1	1	Remove
65153	14	9	Douglas-fir (<i>Pseudotsuga menziesii</i>)		1	1	Remove
65156	13	12	Douglas-fir (<i>Pseudotsuga menziesii</i>)		1	1	Remove
65157	14	12	Douglas-fir (<i>Pseudotsuga menziesii</i>)	Codominant top with included bark; Crooked bole	1	2	Remove
65160	52	27	Douglas-fir (<i>Pseudotsuga menziesii</i>)		1	1	Preserve
65163	8	7	Sweet Cherry (<i>Prunus avium</i>)	Crooked bole	1	2	Remove
65165	9	7	Douglas-fir (<i>Pseudotsuga menziesii</i>)		1	1	Remove
65169	10	9	Douglas-fir (<i>Pseudotsuga menziesii</i>)	1-sided canopy (S)	1	2	Remove
65173	8	6	Douglas-fir (<i>Pseudotsuga menziesii</i>)		1	1	Remove
65177	9	6	Douglas-fir (<i>Pseudotsuga menziesii</i>)	1-sided canopy (W)	1	2	Remove
65178	11	7	Douglas-fir (<i>Pseudotsuga menziesii</i>)		1	1	Remove
65183	10,15	12	Douglas-fir (<i>Pseudotsuga menziesii</i>)	Codominant base	1	2	Remove
65184	10	9	Douglas-fir (<i>Pseudotsuga menziesii</i>)		1	1	Remove
65185	15	26	Bigleaf Maple (<i>Acer macrophyllum</i>)	Failed limbs; 1-sided canopy (N)	1	2	Remove
65187	26	23	Douglas-fir (<i>Pseudotsuga menziesii</i>)		1	1	Remove
65189	12	10	Douglas-fir (<i>Pseudotsuga menziesii</i>)		1	1	Remove
65193	40	21	Douglas-fir (<i>Pseudotsuga menziesii</i>)		1	1	Remove
65195	10	8	Douglas-fir (<i>Pseudotsuga menziesii</i>)		1	1	Remove
65196	14	7	Douglas-fir (<i>Pseudotsuga menziesii</i>)	Crooked top	1	2	Remove
65197	9	7	Douglas-fir (<i>Pseudotsuga menziesii</i>)		1	1	Remove
65198	12	9	Douglas-fir (<i>Pseudotsuga menziesii</i>)		1	1	Remove
65201	44	24	Douglas-fir (<i>Pseudotsuga menziesii</i>)	Broken limbs; 1-sided canopy (S)	1	2	Remove
65202	30	20	Douglas-fir (<i>Pseudotsuga menziesii</i>)		1	1	Remove
65203	31	16	Douglas-fir (<i>Pseudotsuga menziesii</i>)	Lean (S); Deformed bole	1	2	Remove
65204	32	12	Douglas-fir (<i>Pseudotsuga menziesii</i>)	Deformed bole; Codominant stem failed	2	2	Remove
65206	9	6	Douglas-fir (<i>Pseudotsuga menziesii</i>)	Tree fallen on top; Uprooting (W)	1	3	Remove
65208	8	6	Douglas-fir (<i>Pseudotsuga menziesii</i>)		1	1	Remove
65210	8	6	Douglas-fir (<i>Pseudotsuga menziesii</i>)		1	1	Remove
65216	9	7	Douglas-fir (<i>Pseudotsuga menziesii</i>)		1	1	Remove
65218	8	6	Douglas-fir (<i>Pseudotsuga menziesii</i>)		1	1	Remove
65219	8	5	Douglas-fir (<i>Pseudotsuga menziesii</i>)	high canopy	1	2	Remove
65220	9	7	Douglas-fir (<i>Pseudotsuga menziesii</i>)	Cavity with seepage	2	1	Remove
65227	9	7	Douglas-fir (<i>Pseudotsuga menziesii</i>)		1	1	Remove
65228	8	6	Douglas-fir (<i>Pseudotsuga menziesii</i>)		1	1	Remove
65230	10	6	Douglas-fir (<i>Pseudotsuga menziesii</i>)		1	1	Remove
65231	9	7	Douglas-fir (<i>Pseudotsuga menziesii</i>)	1-sided canopy (W)	1	2	Remove
65233	9	5	Douglas-fir (<i>Pseudotsuga menziesii</i>)		1	1	Remove
65234	10	0	Douglas-fir (<i>Pseudotsuga menziesii</i>)	Dead	3	3	Remove
65235	9	5	Douglas-fir (<i>Pseudotsuga menziesii</i>)	High canopy	1	2	Remove
65236	8	6	Douglas-fir (<i>Pseudotsuga menziesii</i>)		1	1	Remove
65242	8	5	Douglas-fir (<i>Pseudotsuga menziesii</i>)		1	1	Remove

Detailed Tree Inventory for Autumn Sunrise

AKS Job No. 7454 - Evaluation Date: 2/1/2021 - 4/12/2021 - Evaluated by: BRK

Tree #	DBH (in.)	Avg. Crown Radius (ft)	Tree Species Common Name (Scientific name)	Comments	Health Rating*	Structure Rating**	Remove/Preserve
65244	11	5	Douglas-fir (<i>Pseudotsuga menziesii</i>)	High canopy	1	2	Remove
65246	8	4	Douglas-fir (<i>Pseudotsuga menziesii</i>)	High canopy	1	2	Remove
65247	8	4	Douglas-fir (<i>Pseudotsuga menziesii</i>)	High canopy	1	2	Remove
65249	8	6	Douglas-fir (<i>Pseudotsuga menziesii</i>)		1	1	Remove
65250	8,9	6	Douglas-fir (<i>Pseudotsuga menziesii</i>)	Codominant base with included bark	1	2	Remove
65253	29	25	Douglas-fir (<i>Pseudotsuga menziesii</i>)		1	1	Remove
65254	14,23	20	Bigleaf Maple (<i>Acer macrophyllum</i>)	Codominant base with included bark	1	2	Remove
65257	11	9	Douglas-fir (<i>Pseudotsuga menziesii</i>)		1	1	Remove
65258	12	8	Douglas-fir (<i>Pseudotsuga menziesii</i>)		1	1	Remove
65259	9	8	Douglas-fir (<i>Pseudotsuga menziesii</i>)		1	1	Remove
65260	10	7	Douglas-fir (<i>Pseudotsuga menziesii</i>)		1	1	Remove
65262	13	11	Douglas-fir (<i>Pseudotsuga menziesii</i>)	1-sided canopy (W)	1	2	Remove
65263	9	10	Douglas-fir (<i>Pseudotsuga menziesii</i>)	1-sided canopy (W)	1	2	Remove
65264	8	6	Douglas-fir (<i>Pseudotsuga menziesii</i>)		1	1	Remove
70000	8	10	Douglas-fir (<i>Pseudotsuga menziesii</i>)	High canopy	1	2	Remove
70001	13	10	Douglas-fir (<i>Pseudotsuga menziesii</i>)	High canopy	1	2	Preserve
70002	13	10	Douglas-fir (<i>Pseudotsuga menziesii</i>)		1	1	Preserve
70003	10	12	Douglas-fir (<i>Pseudotsuga menziesii</i>)	High canopy	1	2	Preserve
112633	7	9	Cherry (<i>Prunus sp.</i>)	OFFSITE; Street Tree	1	1	Preserve
112696	7	9	Cherry (<i>Prunus sp.</i>)	OFFSITE; Street Tree	1	1	Preserve
112721	7	9	Cherry (<i>Prunus sp.</i>)	OFFSITE; Street Tree	1	1	Preserve
120000	9	10	Douglas-fir (<i>Pseudotsuga menziesii</i>)		1	1	Remove
120001	8	6	Douglas-fir (<i>Pseudotsuga menziesii</i>)	Broken top; Sparse canopy	2	3	Remove
120002	9	0	Douglas-fir (<i>Pseudotsuga menziesii</i>)	Dead; Broken at 30'	3	3	Remove
120003	12	10	Douglas-fir (<i>Pseudotsuga menziesii</i>)		1	1	Remove
120004	10	10	Douglas-fir (<i>Pseudotsuga menziesii</i>)		1	1	Remove
120005	8	7	Douglas-fir (<i>Pseudotsuga menziesii</i>)	1-sided canopy (N)	1	2	Remove
120006	16	13	Douglas-fir (<i>Pseudotsuga menziesii</i>)	Crooked; 1-sided canopy (W)	1	2	Remove
120007	12	10	Douglas-fir (<i>Pseudotsuga menziesii</i>)		1	1	Remove
120008	8	7	Douglas-fir (<i>Pseudotsuga menziesii</i>)		1	1	Remove
120009	10	11	Cherry (<i>Prunus sp.</i>)	Codominant with included bark; Exposed roots all around	1	2	Remove
120010	12	9	Douglas-fir (<i>Pseudotsuga menziesii</i>)		1	1	Remove
120011	35	25	Douglas-fir (<i>Pseudotsuga menziesii</i>)		1	1	Remove
120012	8,8,8,8,9	16	Willow (<i>Salix sp.</i>)	Broken branches; Clustered base	1	2	Remove
120013	31	20	Douglas-fir (<i>Pseudotsuga menziesii</i>)		1	1	Remove
120014	28	25	Douglas-fir (<i>Pseudotsuga menziesii</i>)		1	1	Remove
120015	12	9	Douglas-fir (<i>Pseudotsuga menziesii</i>)		1	1	Remove
120016	10	7	Douglas-fir (<i>Pseudotsuga menziesii</i>)		1	1	Remove
120017	11	8	Douglas-fir (<i>Pseudotsuga menziesii</i>)		1	1	Remove
120018	10	7	Douglas-fir (<i>Pseudotsuga menziesii</i>)		1	1	Remove
120019	12	8	Douglas-fir (<i>Pseudotsuga menziesii</i>)		1	1	Remove
120020	12,8,8,8,7	10	Willow (<i>Salix sp.</i>)	Broken tops; Dead limbs; Broken limbs	2	2	Remove
120021	8	5	Douglas-fir (<i>Pseudotsuga menziesii</i>)	High canopy	1	2	Remove
120022	9	6	Douglas-fir (<i>Pseudotsuga menziesii</i>)		1	1	Remove
120023	11	7	Douglas-fir (<i>Pseudotsuga menziesii</i>)		1	1	Remove
120024	12	9	Douglas-fir (<i>Pseudotsuga menziesii</i>)		1	1	Remove
120025	15	11	Douglas-fir (<i>Pseudotsuga menziesii</i>)	Sweep	1	2	Remove
120026	18	19	Douglas-fir (<i>Pseudotsuga menziesii</i>)		1	1	Remove
120027	10	9	Douglas-fir (<i>Pseudotsuga menziesii</i>)	1-sided canopy (W)	1	2	Remove
120028	10	7	Douglas-fir (<i>Pseudotsuga menziesii</i>)		1	1	Remove
120029	13	8	Douglas-fir (<i>Pseudotsuga menziesii</i>)	Crooked bole	1	2	Remove
120030	8	6	Douglas-fir (<i>Pseudotsuga menziesii</i>)	1-sided canopy (W)	1	2	Remove
120031	18	0	Douglas-fir (<i>Pseudotsuga menziesii</i>)	OFFSITE; Evaluated from property line; Dead broken at 50'	3	3	Remove
120032	18	0	Douglas-fir (<i>Pseudotsuga menziesii</i>)	OFFSITE; Evaluated from property line; Dead broken at 50'	3	3	Remove
120033	12	0	Douglas-fir (<i>Pseudotsuga menziesii</i>)	OFFSITE; Evaluated from property line; Dead broken at 20'	3	3	Remove
120036	35	20	Bigleaf Maple (<i>Acer macrophyllum</i>)		1	1	Remove
120037	8	8	Staghorn Sumac (<i>Rhus typhina</i>)	OFFSITE; Recently failed codominant stem leaving large cavity; Exposed roots (S)	1	2	Remove
120038	8	9	Douglas-fir (<i>Pseudotsuga menziesii</i>)	OFFSITE	1	1	Preserve

Total # of Existing Trees Inventoried = 3388

Total # of Existing Onsite Trees = 3141

Total # of Existing Onsite Trees to be Preserved = 77
Total # of Existing Onsite Trees to be Removed = 3064

Total # of Existing Line Trees = 18

Total # of Existing Line Trees to be Preserved = 0
Total # of Existing Line Trees to be Removed = 18

Total # of Existing Offsite Trees = 229

Total # of Existing Offsite Trees to be Preserved = 124
Total # of Existing Offsite Trees to be Removed = 105

***Health Rating:**

- 1 = Good Health - A tree that exhibits typical foliage, bark, and root characteristics, for its respective species, shows no signs of infection or infestation, and has a high level of vigor and vitality.
- 2 = Fair Health - A tree that exhibits some abnormal health characteristics and/or shows some signs of infection or infestation, but may be reversed or abated with supplemental treatment.
- 3 = Poor Health - A tree that is in significant decline, to the extent that supplemental treatment would not likely result in reversing or abating its decline.

****Structure Rating:**

- 1 = Good Structure - A tree that exhibits typical physical form characteristics, for its respective species, shows no signs of structural defects of the canopy, trunk, and/or root system.
- 2 = Fair Structure - A tree that exhibits some abnormal physical form characteristics and/or some signs of structural defects, which reduce the structural integrity of the tree, but are not indicative of imminent physical failure, and may be corrected using arboricultural abatement methods.
- 3 = Poor Structure - A tree that exhibits extensively abnormal physical form characteristics and/or significant structural defects that substantially reduces the structural viability of the tree, cannot feasibly be abated, and are indicative of imminent physical failure.

Arborist Disclosure Statement:

Arborists are tree specialists who use their education, knowledge, training, and experience to examine trees, recommend measures to enhance the health of trees, and attempt to reduce the risk of living near trees. The Client and Jurisdiction may choose to accept or disregard the recommendations of the arborist, or seek additional advice. Arborists cannot detect every condition that could possibly lead to the structural failure of a tree. Trees are living organisms that fail in ways we do not fully understand. Conditions are often hidden within trees and below ground. Arborists cannot guarantee that a tree will be healthy or safe under all circumstances, or for a specified period of time. Likewise, remedial treatments, like medicine, cannot be guaranteed. Trees can be managed, but they cannot be controlled. To live near trees is to accept some degree of risk. The only way to eliminate all risk associated with trees is to eliminate all trees. Neither this author nor AKS Engineering & Forestry, LLC have assumed any responsibility for liability associated with the trees on or adjacent to this site.

At the completion of construction, all trees should once again be reviewed. Land clearing and removal of adjacent trees can expose previously unseen defects and otherwise healthy trees can be damaged during construction.

PRELIMINARY TREE PRESERVATION AND REMOVAL PLAN (N)
AUTUMN SUNRISE SUBDIVISION
LENNAR NORTHWEST, INC.
TUALATIN, OREGON

PRELIMINARY

JOB NUMBER: 7454
 DATE: 7/1/2021
 DESIGNED BY: JSM
 DRAWN BY: JSM
 CHECKED BY: DS

TP-01

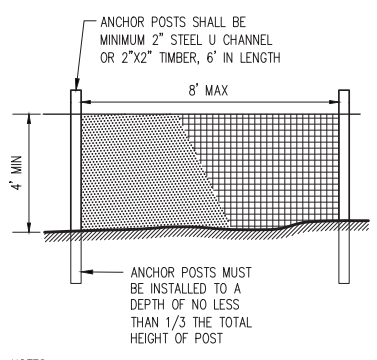
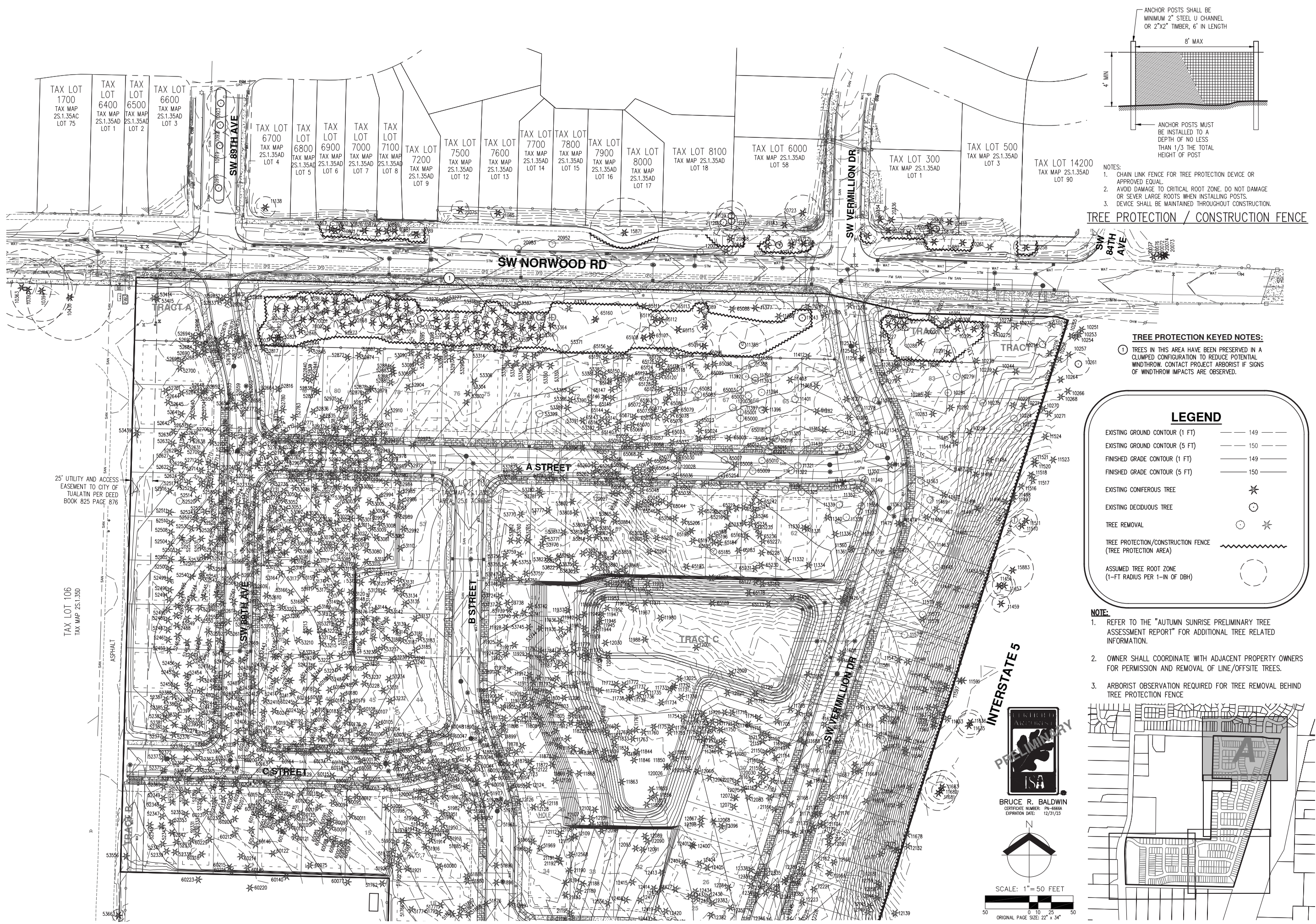

- NOTES:
1. CHAIN LINK FENCE FOR TREE PROTECTION DEVICE OR APPROVED EQUAL.
 2. AVOID DAMAGE TO CRITICAL ROOT ZONE. DO NOT DAMAGE OR SEVER LARGE ROOTS WHEN INSTALLING POSTS.
 3. DEVICE SHALL BE MAINTAINED THROUGHOUT CONSTRUCTION.

TREE PROTECTION / CONSTRUCTION FENCE

TREE PROTECTION KEYED NOTES:

1. TREES IN THIS AREA HAVE BEEN PRESERVED IN A CLUMPED CONFIGURATION TO REDUCE POTENTIAL WINDTHROW. CONTACT PROJECT ARBORIST IF SIGNS OF WINDTHROW IMPACTS ARE OBSERVED.

LEGEND

EXISTING GROUND CONTOUR (1 FT)	---	149
EXISTING GROUND CONTOUR (5 FT)	---	150
FINISHED GRADE CONTOUR (1 FT)	---	149
FINISHED GRADE CONTOUR (5 FT)	---	150
EXISTING CONIFEROUS TREE	*	
EXISTING DECIDUOUS TREE	○	
TREE REMOVAL	○*	
TREE PROTECTION/CONSTRUCTION FENCE (TREE PROTECTION AREA)	~	
ASSUMED TREE ROOT ZONE (1-FT RADIUS PER 1-IN OF DBH)	○	

NOTE:

1. REFER TO THE "AUTUMN SUNRISE PRELIMINARY TREE ASSESSMENT REPORT" FOR ADDITIONAL TREE RELATED INFORMATION.
2. OWNER SHALL COORDINATE WITH ADJACENT PROPERTY OWNERS FOR PERMISSION AND REMOVAL OF LINE/OFFSITE TREES.
3. ARBORIST OBSERVATION REQUIRED FOR TREE REMOVAL BEHIND TREE PROTECTION FENCE

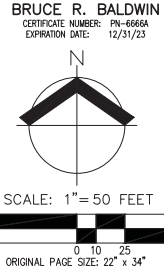
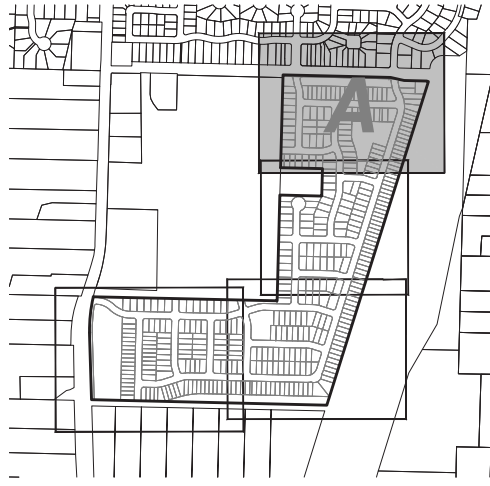

**PRELIMINARY TREE PRESERVATION AND REMOVAL PLAN (CEN)
 AUTUMN SUNRISE SUBDIVISION
 LENNAR NORTHWEST, INC.
 TUALATIN, OREGON**

PRELIMINARY

JOB NUMBER: 7454
 DATE: 7/1/2021
 DESIGNED BY: JSM
 DRAWN BY: JSM
 CHECKED BY: DS

TP-02

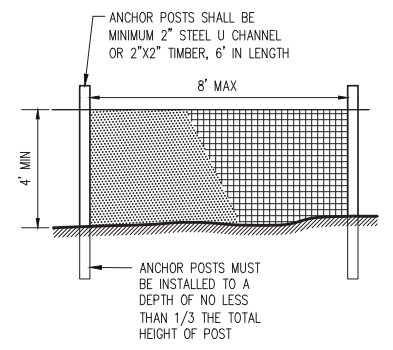
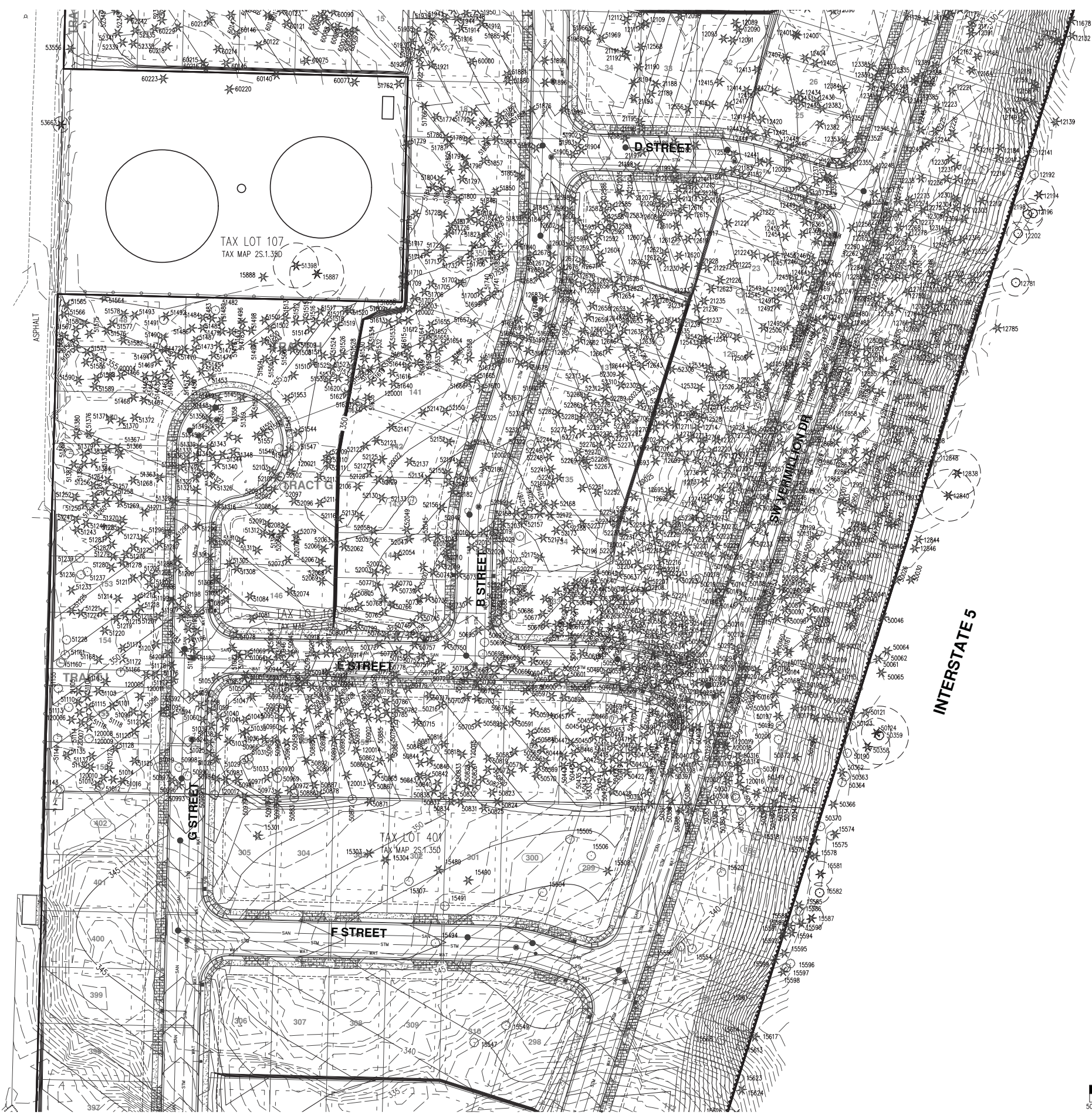

- NOTES:
- CHAIN LINK FENCE FOR TREE PROTECTION DEVICE OR APPROVED EQUAL.
 - AVOID DAMAGE TO CRITICAL ROOT ZONE. DO NOT DAMAGE OR SEVER LARGE ROOTS WHEN INSTALLING POSTS.
 - DEVICE SHALL BE MAINTAINED THROUGHOUT CONSTRUCTION.

TREE PROTECTION / CONSTRUCTION FENCE

LEGEND

EXISTING GROUND CONTOUR (1 FT)	---	149
EXISTING GROUND CONTOUR (5 FT)	---	150
FINISHED GRADE CONTOUR (1 FT)	---	149
FINISHED GRADE CONTOUR (5 FT)	---	150
EXISTING CONIFEROUS TREE	*	
EXISTING DECIDUOUS TREE	○	
TREE REMOVAL	○*	
TREE PROTECTION/CONSTRUCTION FENCE (TREE PROTECTION AREA)	~~~~~	
ASSUMED TREE ROOT ZONE (1-FT RADIUS PER 1-IN OF DBH)	○	

- NOTE:**
- REFER TO THE "AUTUMN SUNRISE PRELIMINARY TREE ASSESSMENT REPORT" FOR ADDITIONAL TREE RELATED INFORMATION.
 - OWNER SHALL COORDINATE WITH ADJACENT PROPERTY OWNERS FOR PERMISSION AND REMOVAL OF LINE/OFFSITE TREES.
 - ARBORIST OBSERVATION REQUIRED FOR TREE REMOVAL BEHIND TREE PROTECTION FENCE

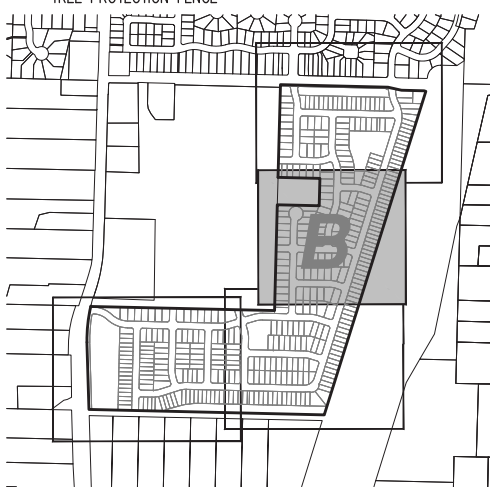

BRUCE R. BALDWIN
 CERTIFICATE NUMBER: PH-6666A
 EXPIRATION DATE: 12/31/23

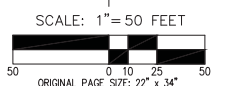
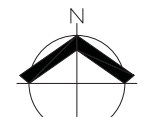

TAX LOT 106
 TAX MAP 2S.1.35D

TAX LOT 106
 TAX MAP 2S.1.35D

TAX LOT 106
TAX MAP 2S.1.35D

TAX LOT 106
TAX MAP 2S.1.35D

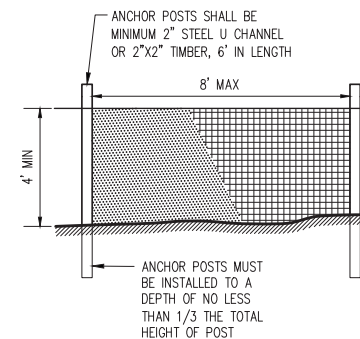
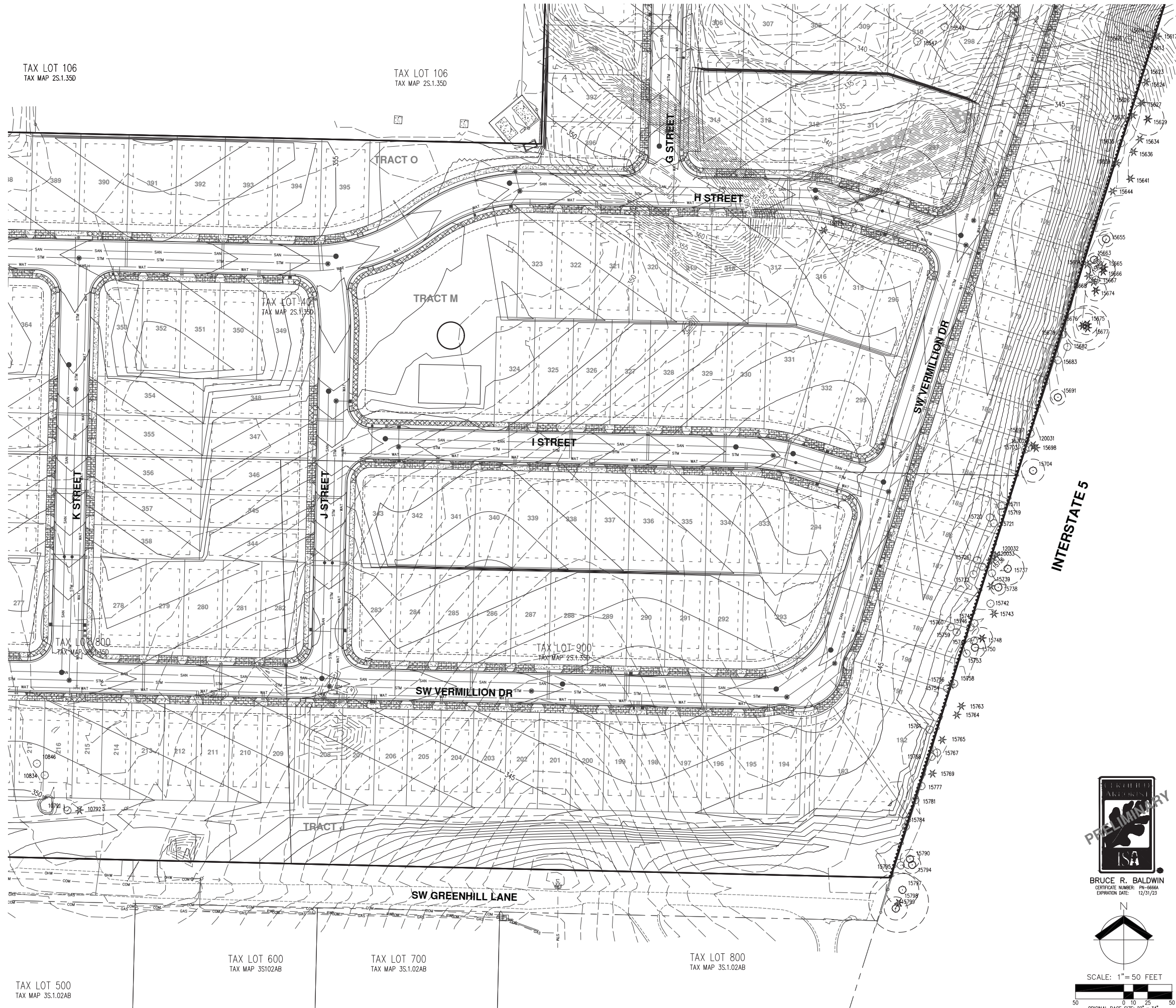

- NOTES:
- CHAIN LINK FENCE FOR TREE PROTECTION DEVICE OR APPROVED EQUAL.
 - AVOID DAMAGE TO CRITICAL ROOT ZONE. DO NOT DAMAGE OR SEVERE LARGE ROOTS WHEN INSTALLING POSTS.
 - DEVICE SHALL BE MAINTAINED THROUGHOUT CONSTRUCTION.

TREE PROTECTION / CONSTRUCTION FENCE

LEGEND

EXISTING GROUND CONTOUR (1 FT)	---	149
EXISTING GROUND CONTOUR (5 FT)	---	150
FINISHED GRADE CONTOUR (1 FT)	---	149
FINISHED GRADE CONTOUR (5 FT)	---	150
EXISTING CONIFEROUS TREE	*	
EXISTING DECIDUOUS TREE	○	
TREE REMOVAL	○*	
TREE PROTECTION/CONSTRUCTION FENCE (TREE PROTECTION AREA)	~~~~~	
ASSUMED TREE ROOT ZONE (1-FT RADIUS PER 1-IN OF DBH)	○	

- NOTE:**
- REFER TO THE "AUTUMN SUNRISE PRELIMINARY TREE ASSESSMENT REPORT" FOR ADDITIONAL TREE RELATED INFORMATION.
 - OWNER SHALL COORDINATE WITH ADJACENT PROPERTY OWNERS FOR PERMISSION AND REMOVAL OF LINE/OFFSITE TREES.
 - ARBORIST OBSERVATION REQUIRED FOR TREE REMOVAL BEHIND TREE PROTECTION FENCE

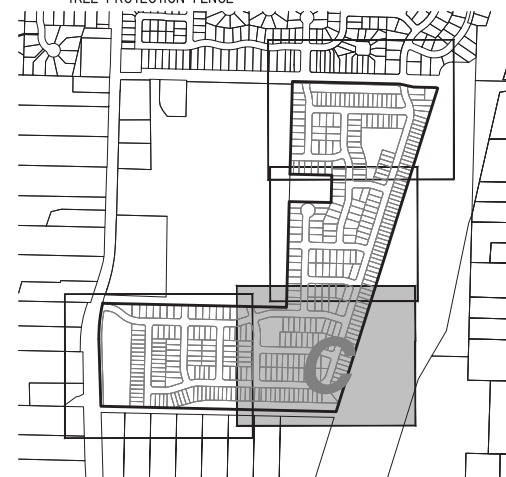

BRUCE R. BALDWIN
CERTIFICATE NUMBER: PN-6662A
EXPIRATION DATE: 12/31/23

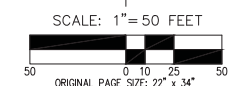
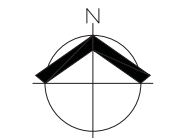

JOB NUMBER:	7454
DATE:	7/1/2021
DESIGNED BY:	JSM
DRAWN BY:	JSM
CHECKED BY:	DS

TAX LOT 200
TAX MAP 2S.1.35CB

TAX LOT 303
TAX MAP 2S.1.35D

TAX LOT 106
TAX MAP 2S.1.35D

TAX LOT 302
TAX MAP 2S.1.35CB

TAX LOT 300
TAX MAP 2S.1.35CB

TAX LOT 400
TAX MAP 2S.1.35CB

TAX LOT 100
TAX MAP 3S.1.02AB

TAX LOT 200
TAX MAP 3S.1.02AB

TAX LOT 300
TAX MAP 3S.1.02AB

TAX LOT 400
TAX MAP 3S.1.02AB

TAX LOT 500
TAX MAP 3S.1.02AB

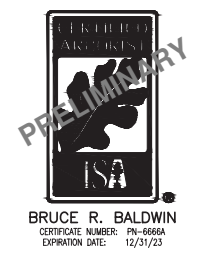
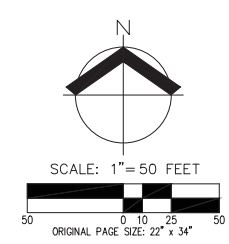
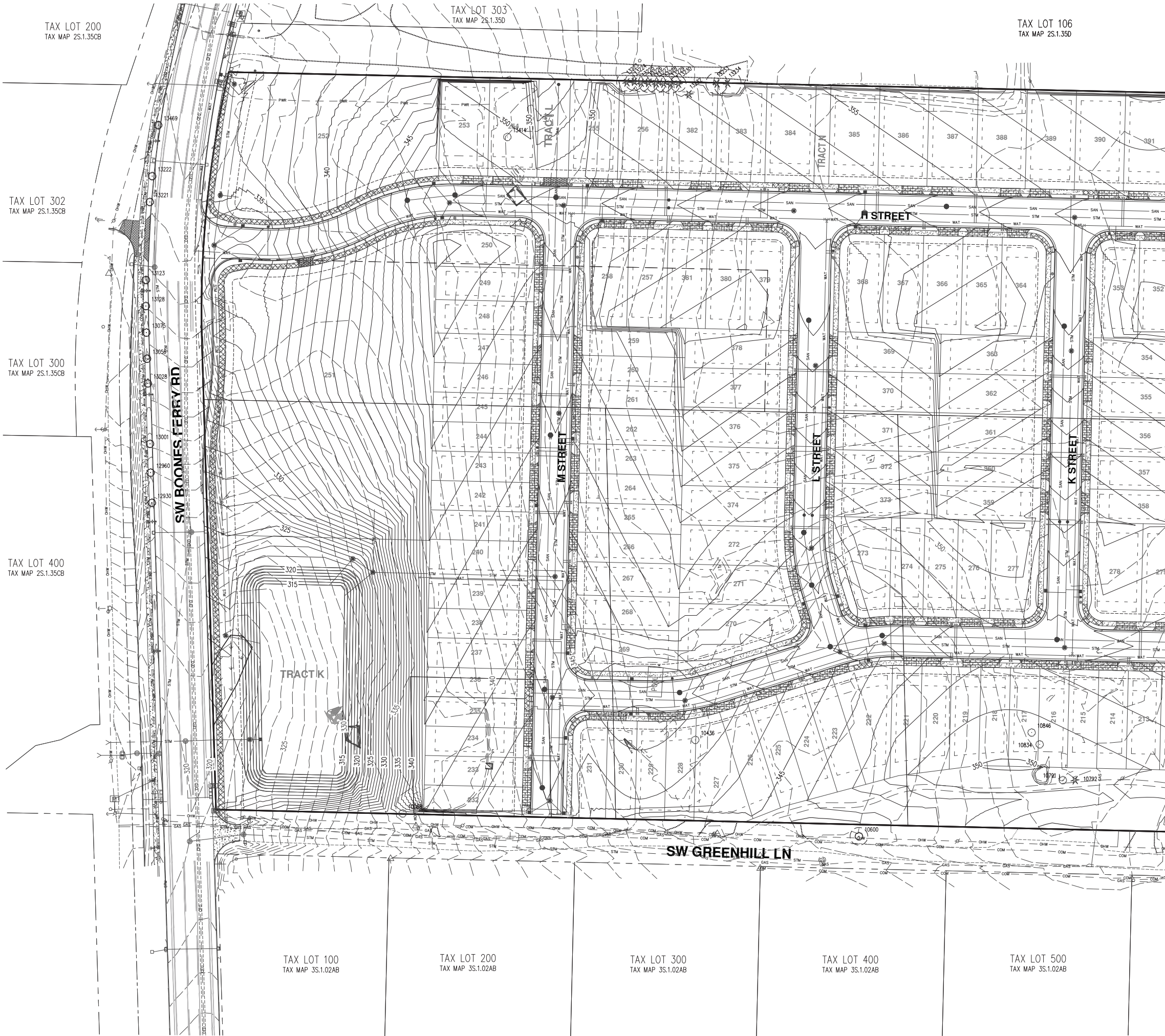

LEGEND	
EXISTING GROUND CONTOUR (1 FT)	--- 149 ---
EXISTING GROUND CONTOUR (5 FT)	--- 150 ---
FINISHED GRADE CONTOUR (1 FT)	--- 149 ---
FINISHED GRADE CONTOUR (5 FT)	--- 150 ---
EXISTING CONIFEROUS TREE	* (with star symbol)
EXISTING DECIDUOUS TREE	○ (with circle symbol)
TREE REMOVAL	○ * (with circle and star symbol)
TREE PROTECTION/CONSTRUCTION FENCE (TREE PROTECTION AREA)	~ (with wavy line symbol)
ASSUMED TREE ROOT ZONE (1-FT RADIUS PER 1-IN OF DBH)	○ (with dashed circle symbol)

- NOTE:**
- REFER TO THE "AUTUMN SUNRISE PRELIMINARY TREE ASSESSMENT REPORT" FOR ADDITIONAL TREE RELATED INFORMATION.
 - OWNER SHALL COORDINATE WITH ADJACENT PROPERTY OWNERS FOR PERMISSION AND REMOVAL OF LINE/OFFSITE TREES.
 - ARBORIST OBSERVATION REQUIRED FOR TREE REMOVAL BEHIND TREE PROTECTION FENCE

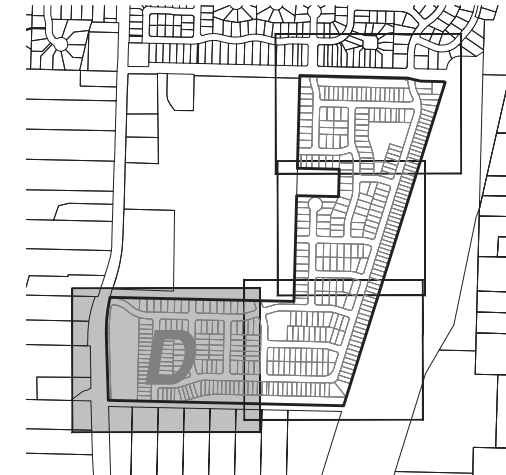

AKS
AKS ENGINEERING & FORESTRY, LLC
12865 SW HERMAN RD., STE. 100
TUALATIN, OR 97062
503.563.6151
WWW.AKS-ENG.COM
ENGINEERING • SURVEYING • NATURAL RESOURCES
FORESTRY • PLANNING • LANDSCAPE ARCHITECTURE

**PRELIMINARY TREE PRESERVATION AND REMOVAL PLAN (SW)
AUTUMN SUNRISE SUBDIVISION
LENNAR NORTHWEST, INC.
TUALATIN, OREGON**

PRELIMINARY

JOB NUMBER: 7454
DATE: 7/1/2021
DESIGNED BY: JSM
DRAWN BY: JSM
CHECKED BY: DS

TP-04

Norwood Pump Station



June 30, 2021 Neighborhood Meeting



Summary

- Meeting Purpose: Land Use Review of a Sanitary Sewer Pump Station for the Proposed Autumn Sunrise Residential Development
- Autumn Sunrise Residential Development: Held a neighborhood meeting June 9th
- Pump Station Location: Northeast corner of Tax Lot 100 of Map 2S 1 35D. This is the Southeast Corner of Norwood Road and Vermillion Drive (map provided later on)
- Pump Station Property Zoning: City of Tualatin's Medium-Low Density Residential Zone
- Land Use Review: Includes City of Tualatin Architectural Review (AR)



Similar pump station as viewed from the street. The proposed pump station will have landscaping to provide screening of utilities.

Clean Water Services

- Public utility district that specializes in water resources management.
- Serves nearly 600,000 residents inside the urban growth boundary of Washington County.



Services include:

- Innovative wastewater and stormwater services
 - Operates 4 treatment facilities
 - Operates 44 pump stations
 - Municipal separate storm sewer program (MS4)
- River flow management
- Water quality and stream enhancement projects
- More

Clean Water Services

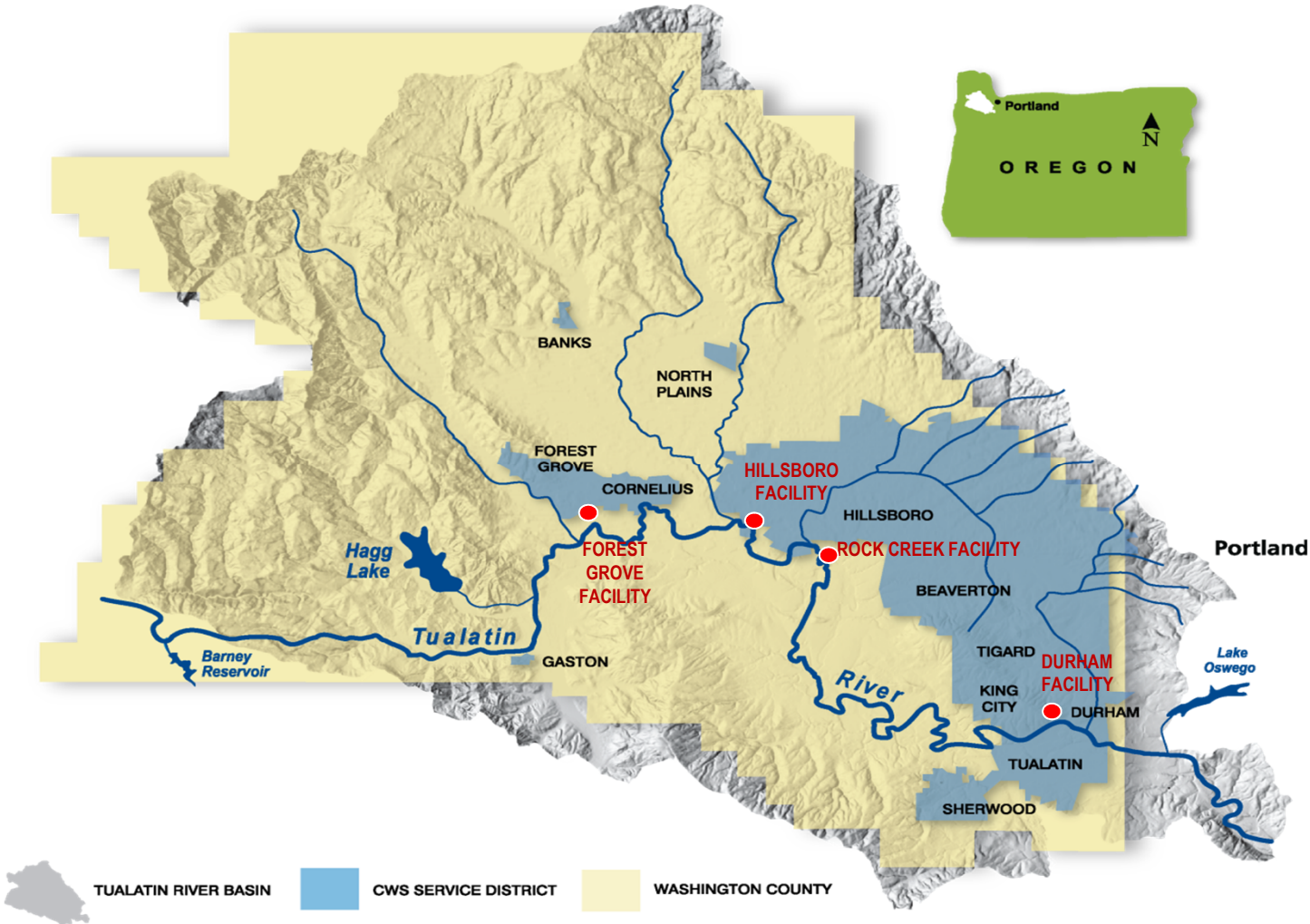

What is a Sanitary Sewer Pump Station?

"How the sewer works" graphic provided by Des Moines Metropolitan Wastewater Reclamation Authority

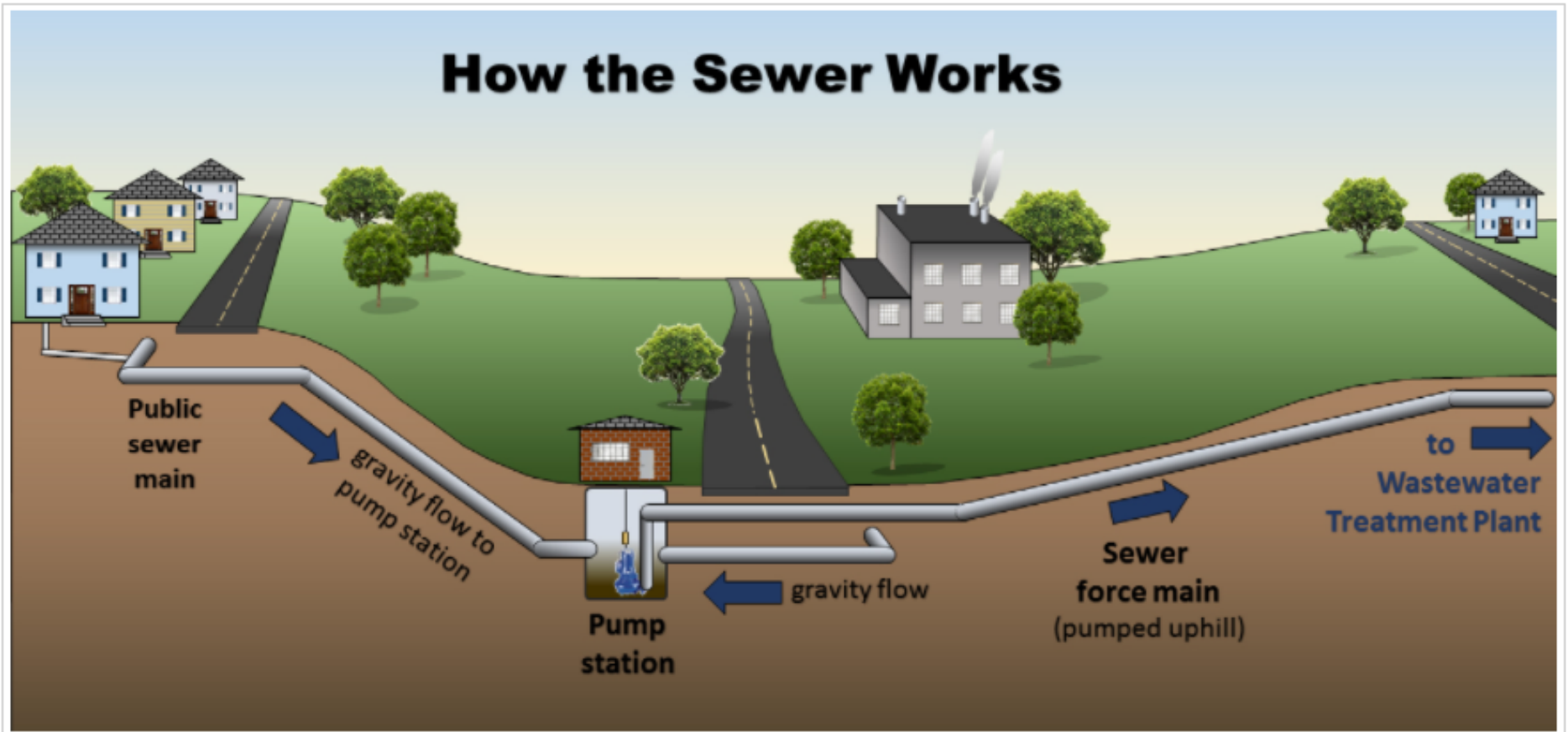

Location Map

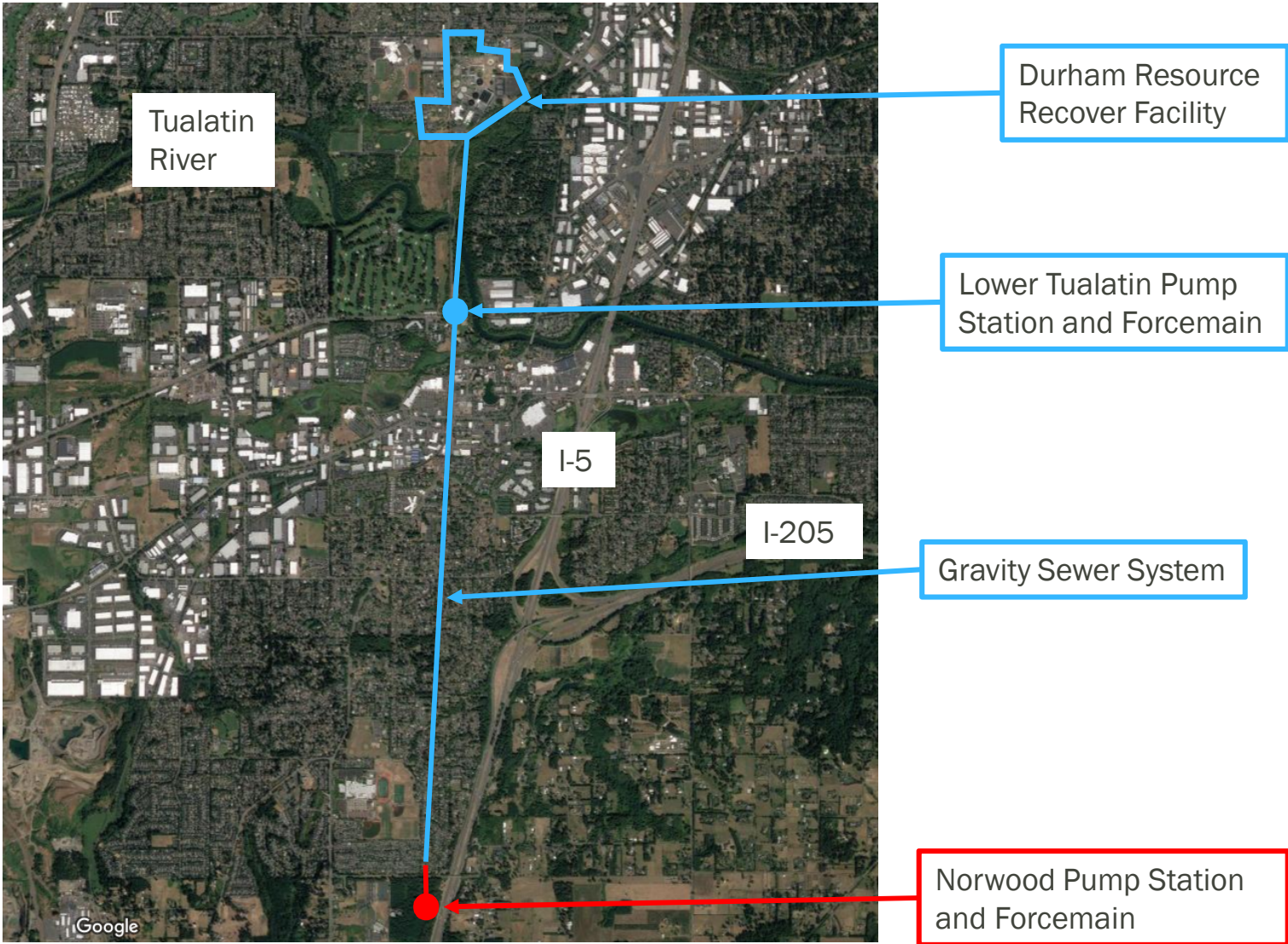

Location Map

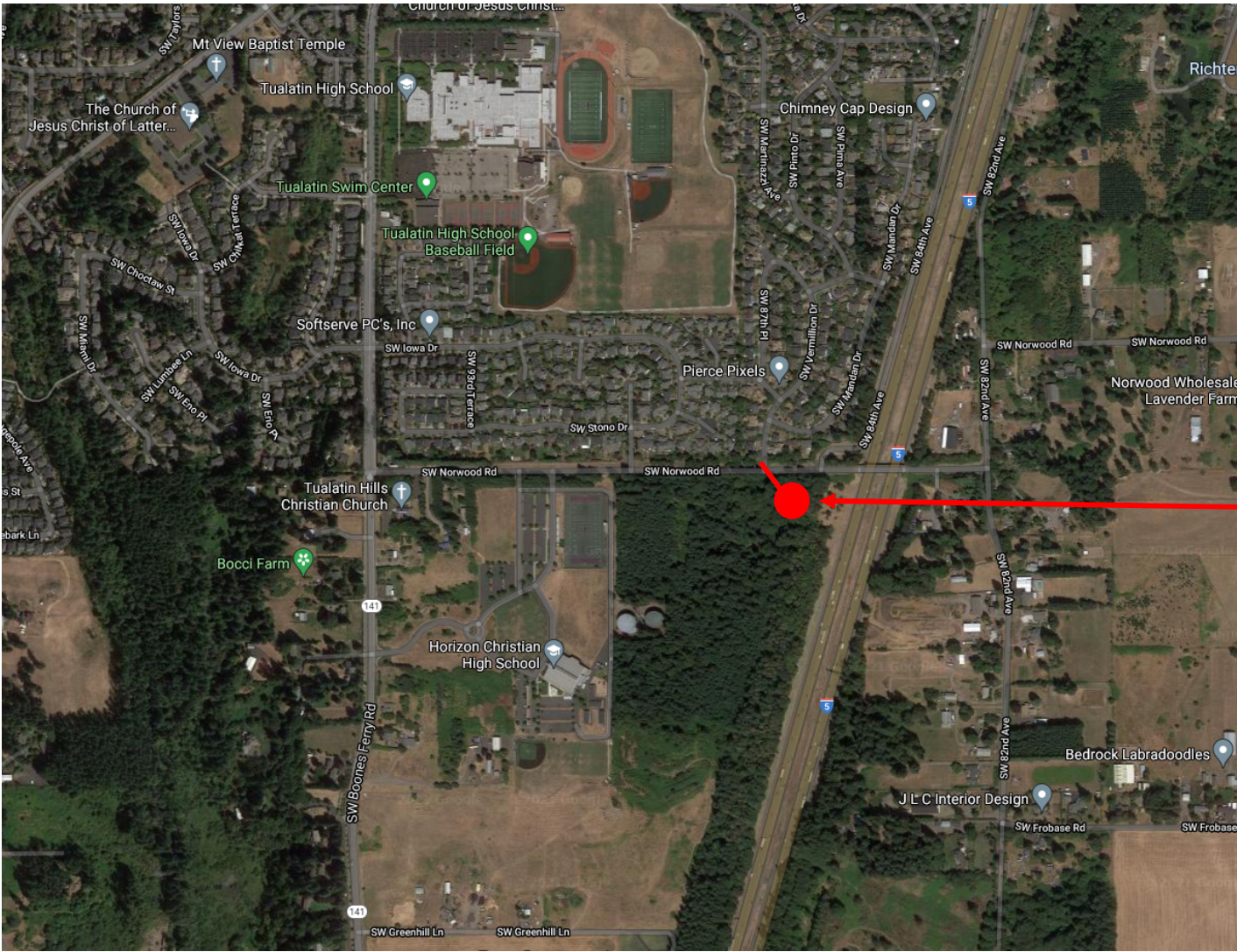

Norwood Pump Station and Forcemain

Vicinity Map

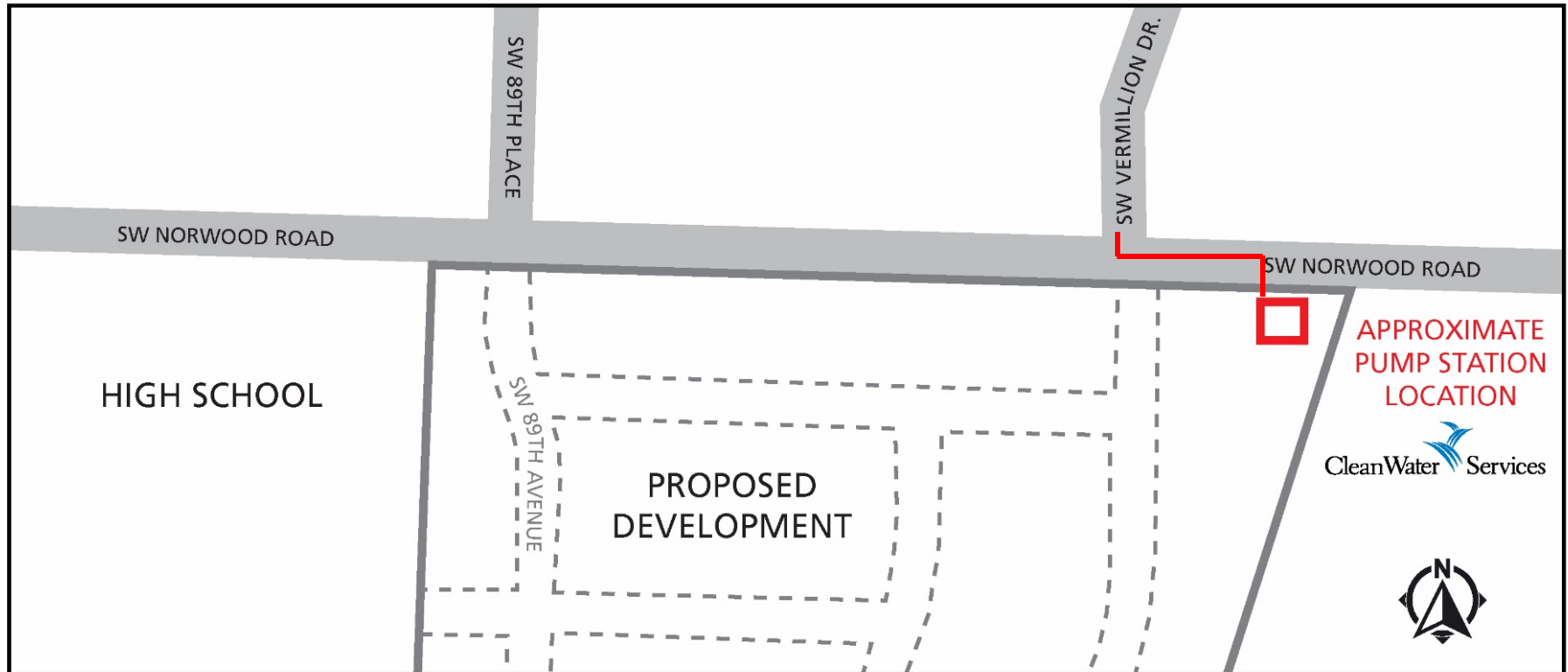

Preliminary Site Plan

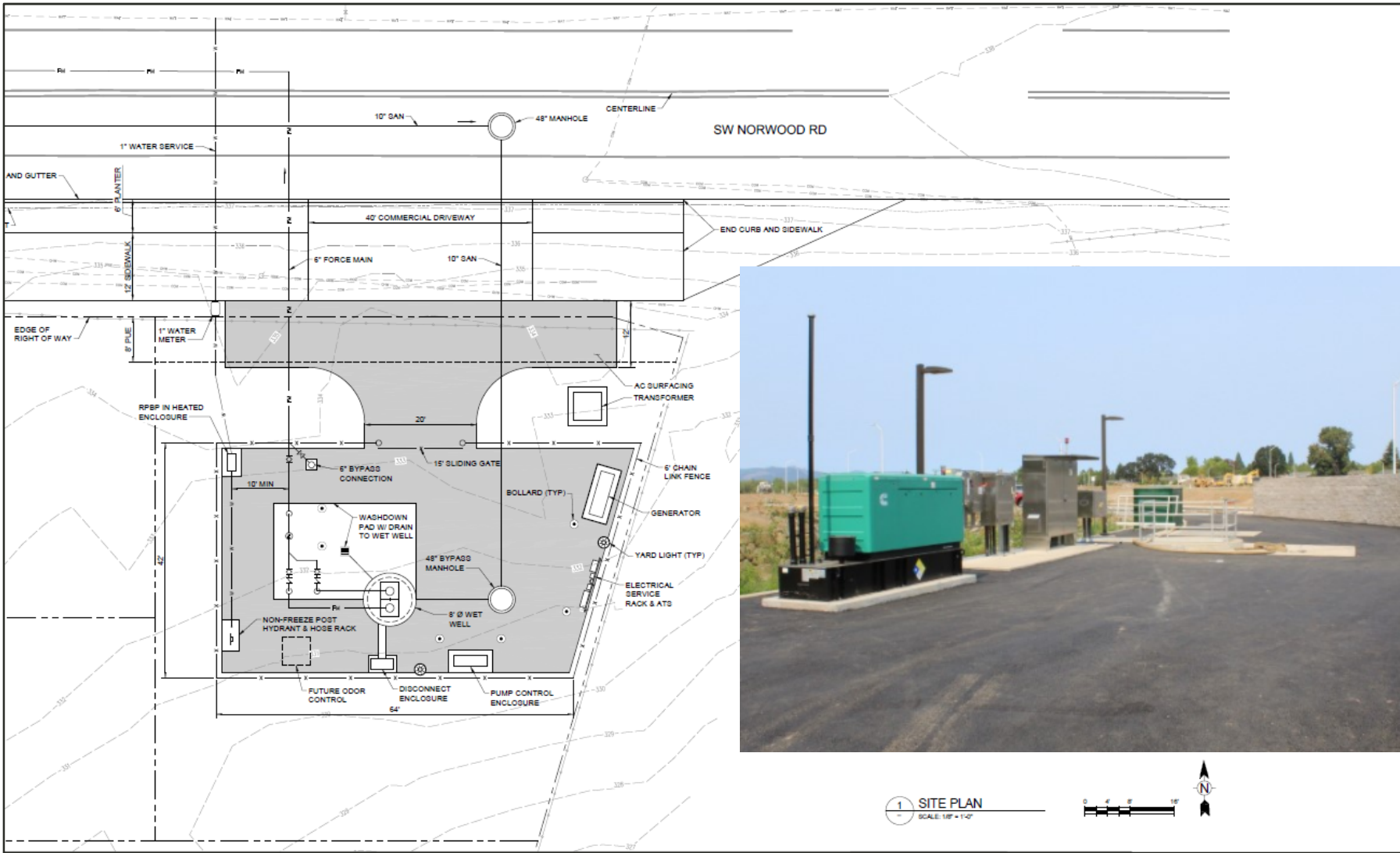

Process

Application

- Pre-application conference
- Neighborhood Meeting

City Council

- Hearing
- Adoption

City Review

- Notice/site posting
- Staff Report

Q & A

We will make our best effort to answer all question(s) during and after the meeting

To Ask A Question:

- Use the “Chat” button on the presentation screen to submit a question in real time.

After the Meeting:

- We will continue to take questions once the meeting has ended. Please submit your question(s) to: hartj@cleanwaterservices.org

AFFIDAVIT OF MAILING NOTICE

STATE OF OREGON)
) SS
COUNTY OF WASHINGTON)

I, Jeff Hart being first duly sworn, depose and say:

That on the 15 day of June, 2021, I served upon the persons shown on Exhibit "A" (Mailing Area List), attached hereto and by this reference incorporated herein, a copy of the Notice of Neighborhood/Developer Meeting marked Exhibit "B," attached hereto and by this reference incorporated herein, by mailing to them a true and correct copy of the original hereof. I further certify that the addresses shown on said Exhibit "A" are their regular addresses as determined from the books and records of the Washington County and/or Clackamas County Departments of Assessment and Taxation Tax Rolls, and that said envelopes were placed in the United States Mail with postage fully prepared thereon.

[Signature]
Signature

SUBSCRIBED AND SWORN to before me this 12th day of August, 2021.

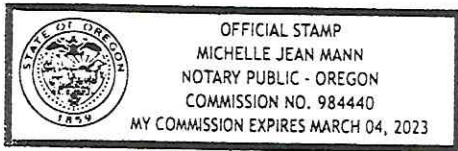

[Signature]
Notary Public for Oregon
My commission expires:

RE: _____

CERTIFICATION OF SIGN POSTING

<p>NOTICE</p> <p>NEIGHBORHOOD / DEVELOPER MEETING</p> <p>__/__/2010 __:__.m.</p> <p>SW _____</p> <p>503-__-__</p>

In addition to the requirements of TDC 32.150, the 18" x 24" sign must display the meeting date, time, and address as well as a contact phone number. The block around the word "NOTICE" must remain **orange** composed of the RGB color values Red 254, Green 127, and Blue 0. A PowerPoint template of this sign is available at: <https://www.tualatinoregon.gov/planning/land-use-application-sign-templates>.

As the applicant for the Norwood Pump Station project, I hereby certify that on this day, 1 sign(s) was/were posted on the subject property in accordance with the requirements of the Tualatin Development Code and the Community Development Division.

Applicant's Name: Eric Hawkinson
(Please Print)

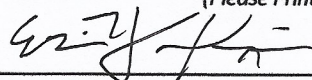
Applicant's Signature: 

Date: 6/15/21



FIRST AMERICAN TITLE Property Research Report

SUBJECT PROPERTY

R560164
2S135D000100
Washington

OWNER

P3 Properties LLC
By Paul Pennington

DATE PREPARED

04/02/2020

PREPARED BY

samaya@firstam.com



First American Title

Customer Service 503.219.8746
cs.oregon@firstam.com

©2018 First American Financial Corporation and/or its affiliates.

All rights reserved. | NYSE: FAF | 39203000418



First American Title™

Customer Service Department

Phone: 503.219.TRIO (8746)

Fax: 503.790.7872

Email: cs.oregon@firstam.com

Date: 4/2/2020

OWNERSHIP INFORMATION

Owner: P3 Properties LLC

CoOwner: By Paul Pennington

Site: OR 97062

Mail: PO Box 691 White Salmon WA 98672

Parcel #: R560164

Ref Parcel #: 2S135D000100

TRS: 02S / 01W / 35 / SE

County: Washington

PROPERTY DESCRIPTION

Map Grid: 715-E1

Census Tract: 032110 Block: 1004

Neighborhood: Cpo 5 Sherwood-Tualatin S1

School Dist: 88J Sherwood

Impr Type:

Subdiv/Plat:

Land Use: 6404 - Designated Forestland - Vacant - Rural
Residential

Std Land Use: OTHR - Other

Zoning: Tualatin-RML - Medium-Low Density Residential

Lat/Lon: 45.35193877 / -122.76768864

Watershed: Fanno Creek-Tualatin River

Legal: ACRES 25.18, FORESTLAND-POTENTIAL
ADDITIONAL TAX LIABILITY

ASSESSMENT AND TAXATION

Market Land: \$0.00

Market Impr: \$0.00

Market Special: \$1,948,650.00

Market Total: \$1,948,650.00 (2019)

% Improved: 0.00%

Assessed Total: \$12,050.00 (2019)

Levy Code: 88.13

Tax: \$186.50 (2019)

Millage Rate: 15.4786

Exemption:

Exemption Type:

PROPERTY CHARACTERISTICS

Bedrooms:	Total SqFt:	Year Built:
Baths, Total:	First Floor:	Eff Year Built:
Baths, Full:	Second Floor:	Lot Size Ac: 25.18 Acres
Baths, Half:	Basement Fin:	Lot Size SF: 1,096,841 SqFt
Total Units: 1	Basement Unfin:	Lot Width:
# Stories:	Basement Total:	Lot Depth:
# Fireplaces:	Attic Fin:	Roof Material:
Cooling:	Attic Unfin:	Roof Shape:
Heating:	Attic Total:	Ext Walls: Wood
Building Style:	Garage:	Const Type:

SALES AND LOAN INFORMATION

Owner	Date	Doc #	Sale Price	Deed Type	Loan Amt	Loan Type
P3 PROPERTIES LLC	2/25/2015	0000012686		Grant		Conv/Unk
PENNINGTON,PAUL	8/19/2013	0000075740		Quit Claim		
PENNINGTON,PAUL	7/11/2013	0000063209		Quit Claim		
PENNINGTON,DORTHEA	1/8/2013	0000001861		Trust	\$135,000.00	

Sentry Dynamics, Inc. and its customers make no representations, warranties or conditions, express or implied, as to the accuracy or completeness of information contained in this report.

SEE MAP
25 | 35AC

SEE MAP
25 | 35AD

S.W. 69TH AVENUE

S.W. VERMILLION DRIVE

(CR. 1183)

105
700AC

106
37.00 AC

3-13

100
25.00 AC



107
1.24 AC

108
156.00 AC

88-15

88-13

FREEWAY

CANCELLED TAX LOTS
104, 105, 200, 201, 202, 1000-1-1,
102, 203, 602, 1003, 10, 202, 600,
907, 1004, 402, 408,

SEE MAP
25 | 36C

FOR ASSESSMENT
PURPOSES ONLY
DO NOT RELY ON
FOR ANY OTHER USE

TUALATIN

ORCHARD

TRACT

4

5

6

9

8

7

REPHILL LANE

SEE MAP
35 | 02AB

SEE MAP
35 | 02A

TUALATIN
25 | 35D



First American Title™

02/25/2015 11:18:23 AM

D-DBS Cnt=1 Str=12 S PFEIFER
\$15.00 \$5.00 \$11.00 \$20.00 - Total = \$51.00



02016302201500126860030038

I, Richard Hobernicht, Director of Assessment and Taxation and Ex-Officio County Clerk for Washington County, Oregon, do hereby certify that the within instrument of writing was received and recorded in the book of records of said county.

Richard Hobernicht, Director of Assessment and Taxation, Ex-Officio County Clerk



15
36

After recording return to:
P3 Properties, LLC
c/o Paul Pennington
P.O. Box 691
White Salmon, WA 98672

Until further notice, all tax statements should be sent to:
P3 Properties, LLC
c/o Paul Pennington
P.O. Box 691
White Salmon, WA 98672

Tax Account No. 2S135D0 00100
Ref No. R0560164

True actual consideration paid is \$ 0

BARGAIN AND SALE DEED

Paul Pennington, Janet Pennington Peterson, and Gay Pennington Paschoal, as equal tenants in common, Grantors, do hereby convey unto P3 Properties, LLC, an Oregon limited liability company, Grantee, all of their right, title, and interest in that certain real property, with the tenements, hereditaments and appurtenances thereunto belonging or in any way appertaining, situated in Washington County, State of Oregon, described as follows, to-wit:

SEE ATTACHED EXHIBIT "A"

To have and to hold the same unto the said grantee and grantee's successors and assigns forever.

BEFORE SIGNING OR ACCEPTING THIS INSTRUMENT, THE PERSON TRANSFERRING FEE TITLE SHOULD INQUIRE ABOUT THE PERSON'S RIGHTS, IF ANY, UNDER ORS 195.300, 195.301 AND 195.305 TO 195.336 AND SECTIONS 5 TO 11, CHAPTER 424, OREGON LAWS 2007, SECTIONS 2 TO 9 AND 17, CHAPTER 855, OREGON LAWS 2009, AND SECTIONS 2 TO 7, CHAPTER 8, OREGON LAWS 2010. THIS INSTRUMENT DOES NOT ALLOW USE OF THE PROPERTY DESCRIBED IN THIS INSTRUMENT IN VIOLATION OF APPLICABLE LAND USE LAWS AND REGULATIONS. BEFORE SIGNING OR ACCEPTING THIS INSTRUMENT, THE PERSON ACQUIRING FEE TITLE TO THE PROPERTY SHOULD CHECK WITH THE APPROPRIATE CITY OR COUNTY PLANNING DEPARTMENT TO VERIFY THAT THE UNIT OF LAND BEING TRANSFERRED IS A LAWFULLY ESTABLISHED LOT OR PARCEL, AS DEFINED IN ORS 92.010 OR 215.010, TO VERIFY THE APPROVED USES OF THE LOT OR PARCEL, TO DETERMINE ANY LIMITS ON LAWSUITS AGAINST FARMING OR FOREST PRACTICES, AS DEFINED IN ORS 30.930, AND TO INQUIRE ABOUT THE RIGHTS OF NEIGHBORING PROPERTY OWNERS, IF ANY, UNDER ORS 195.300, 195.301 AND 195.305 TO 195.336 AND SECTIONS 5 TO 11, CHAPTER 424,

OREGON LAWS 2007, SECTIONS 2 TO 9 AND 17, CHAPTER 855, OREGON LAWS 2009, AND SECTIONS 2 TO 7, CHAPTER 8, OREGON LAWS 2010.

DATED: 2/12/2015

Paul Pennington 2/9/2015
Paul Pennington

Janet Pennington Peterson
Janet Pennington Peterson

Gay Pennington Paschoal
Gay Pennington Paschoal

STATE OF Washington)
County of Klickitat) §

This instrument was acknowledged before me on 2-9-2015, 2014, by Paul Pennington.

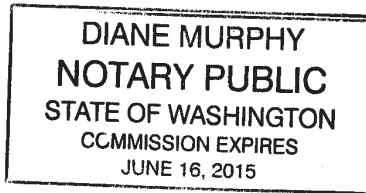

Diane Murphy
Notary Public for ~~Oregon~~ Washington

STATE OF OREGON)
County of Benton) §

This instrument was acknowledged before me on 2/12/2015, by Janet Pennington Peterson.

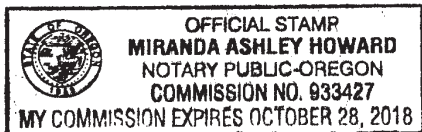

Miranda Ashley Howard
Notary Public for Oregon

STATE OF OREGON)
County of Washington) §

This instrument was acknowledged before me on Feb 5, 2015, 2014, by Gay Pennington Paschoal.

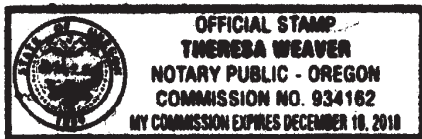

Theresa Weaver
Notary Public for Oregon

EXHIBIT "A"

All interest in 25.18 acres of land, located at S.W. Norwood Ave., Tualatin, Oregon 97062, more particularly described as:

The North half of the Northwest quarter of the Southeast quarter and the Northeast quarter of the Southeast quarter of Section 35, Township 2 South, Range 1 West of the Willamette Meridian, in Washington County, Oregon,

EXCEPTING tract conveyed to the State of Oregon, by and through its State Highway Commission, in deed book 325, page 183, as follows: A parcel of land lying in the Northeast quarter of the Southeast quarter of Section 35, T2S, R1W, W.M.; the said parcel being that portion of said Northeast quarter of the Southeast quarter lying Easterly of a line parallel to and 100 feet Westerly of the centerline of the West Portland-Hubbard Highway as said highway has been relocated, which centerline is described as follows:

Beginning at Engineer's centerline Station 349/00, said Station being 115.27 feet North and 78.52 feet East of the East quarter corner of said section 35; thence South 15°49'15" West 1600 feet to Station 365/00; said centerline crossing the East and South lines of said Northeast quarter of the Southeast quarter approximately at Section 351/83 and Station 363/91 respectively;

ALSO EXCEPTING that tract conveyed to the State of Oregon, by and through its State Highway Commission, by deed in book 341, page 233; ALSO EXCEPTING the following described premises: Beginning at an iron bar marking the center of Section 35, T2S, R1W, W.M., Washington County, Oregon; thence South along the West line of the Southeast quarter of said Section 35 to the Southwest corner of tract conveyed to Merle Pennington and Dorthea Pennington by deed of record in book 417 at page 314, Deed Records of Washington County; thence East along the South line of said tract so conveyed 16 rods and 30 feet to a point; thence North parallel to the West line of said Southeast quarter of said Section 35 to the North line of said Southeast quarter of Section 35; thence West along the North line of said Southeast quarter 16 rods and 30 feet to the point of beginning;

ALSO EXCEPTING the following parcels: Parcel conveyed to Shope, described in instrument of record in book 575, page 110, October 13, 1965, Washington County Records; parcel conveyed to School District 88J, described in instrument of record in Book 767, page 495, December 17, 1969, Washington County Records; and parcel conveyed to City of Tualatin described in instrument of record in Book 825, Page 873, 1971, Washington County Records.

Also identified as Washington County Tax Lot 100 on Tax Map 2S135D