



City of Tualatin

www.tualatinoregon.gov

"NECESSARY PARTIES"
MARKED BELOW

NOTICE OF APPLICATION SUBMITTAL

- ANNEXATION CONDITIONAL USE PERMIT PLAN TEXT AMENDMENT
 ARCHITECTURAL REVIEW PLAN MAP AMENDMENT OTHER:

CASE/FILE: AR17-0011 (Community Development Dept.: Planning Division)

PROPOSAL	Building improvements include: a 16,600-square-foot addition along the southern perimeter of the main high school extending from the south Main Entry east to the existing corridor near the Auditorium; a 2,000-square-foot addition to the Commons' north end; a 3,700-square-foot addition at the northeast corner of the main building; and a 3,200-square-foot expansion to the Career Technical Education (CTE) Wing. Improvements are also proposed for the athletic fields on the east side of the campus.
-----------------	--

PROPERTY <input type="checkbox"/> n/a	Name of Application	Tualatin High School Modifications			
	Street Address	22300 SW Boones Ferry Road			
	Tax Map and Lot No(s).	2S1 35A 000700			
	Planning District	RL	Overlays <input type="checkbox"/>	NRPO <input type="checkbox"/>	Flood Plain <input type="checkbox"/>
	Previous Applications	CUP90-04, VAR90-03, AR90-29, AR91-01, AR91-03, AR93-13, AR93-22, AR94-17, VAR96-04, AR96-42, AR97-11, AR97-16, AR04-04	Additional Applications: N/A		CIO 6

DATES	Receipt of application	10/26/17	Deemed Complete	1/08/18	CONTACT	Name: Erin Engman	
	Notice of application submittal					1/10/18	Title: ASSOCIATE PLANNER
	Project Status / Development Review meeting					11/7/17	E-mail: EENGMAN @tualatin.gov
	Comments due for staff report					01/24/18	Phone: 503-691-3024
	Public meeting: <input type="checkbox"/> ARB <input type="checkbox"/> TPC <input checked="" type="checkbox"/> n/a						Notes: You may view the application materials through this City web page: www.tualatinoregon.gov/projects
	City Council (CC) <input checked="" type="checkbox"/> n/a						

City Staff

- City Manager
- Building Official
- Chief of Police
- City Attorney
- City Engineer
- Community Development Director
- Community Services Director
- Economic Development liaison
- Engineering Associate*
- Finance Director
- GIS technician(s)
- IS Manager
- Operations Director*
- Parks and Recreation Coordinator
- Planning Manager
- Street/Sewer Supervisor
- Water Supervisor

Neighboring Cities

- Durham
- King City Planning Commission
- Lake Oswego
- Rivergrove PC
- Sherwood Planning Dept.

- Tigard Community Dev. Dept.
- Wilsonville Planning Division

Counties

- Clackamas County Dept. of Transportation and Development
- Washington County Dept. of Land Use and Transportation (ARs)
- Washington County Long Range Planning (LRP) (Annexations)

Regional Government

- Metro

School Districts

- Lake Oswego School Dist. 7J
- Sherwood SD 88J
- Tigard-Tualatin SD 23J (TTSD)
- West Linn-Wilsonville SD 3J

State Agencies

- Oregon Dept. of Aviation
- Oregon Dept. of Environmental Quality (DEQ)
- Oregon Dept. of Land Conservation and Development (DLCD) (via proprietary notice)
- Oregon Dept. of State Lands: Wetlands

Program

- Oregon Dept. of Transportation (ODOT) Region 1
- ODOT Maintenance Dist. 2A
- ODOT Rail Division
- OR Dept. of Revenue

Utilities

- Republic Services
- Clean Water Services (CWS)
- Comcast [cable]*
- Frontier Communications [phone]
- Northwest Natural [gas]
- Portland General Electric (PGE)
- TriMet
- Tualatin Valley Fire & Rescue
- USPS (Washington; 18850 SW Teton)
- USPS (Clackamas)
- Washington County Consolidated Communications Agency

Additional Parties

- Tualatin Citizen Involvement Organization (CIO)

***Paper Copies**

- 1.032: Burden of Proof
- 31.071 Architectural Review Procedure
- 31.074 Architectural Review Application Review Process
- 31.077 Quasi-Judicial Evidentiary Hearing Procedures
- Metro Code 3.09.045 Annexation Review Criteria
- 32.030 Criteria for Review of Conditional Uses
- 33.020 Conditions for Granting a Variance that is not a Sign or a Wireless Communication Facility
- 33.022 Criteria for Granting a Sign Variance
- 33.024 Criteria for Granting a Minor Variance
- 33.025 Criteria for Granting a Variance
- 34.200 Tree Cutting on Private Property without Architectural Review, Subdivision or Partition Approval, or Tree Removal Permit Prohibited
- 34.210 Application for Architectural Review, Subdivision or Partition Review, or Permit
- 34.230 Criteria(tree removal)
- 35.060 Conditions for Granting Reinstatement of Nonconforming Use
- 36.160 Subdivision Plan Approval
- 36.230 Review Process (partitioning)
- 36.330 Review Process
- 37.030 Criteria for Review (IMP)
- 40.030 Conditional Uses Permitted (RL)
- 40.060 Lot Size for Conditional Uses (RL)
- 40.080 Setback Requirements for Conditional Uses (RL)
- 41.030 Conditional Uses Permitted (RML)
- 41.050 Lot Size for Conditional Uses (RML)
- 41.070 Setback Requirements for Conditional Uses (RML)
- 42.030 Conditional Uses Permitted (RMH)
- 42.050 Lot Size for Conditional Uses (RMH)
- 42.070 Setback Requirements for Conditional Uses (RMH)
- 43.030 Conditional Uses Permitted (RH)
- 43.060 Lot Size for Conditional Uses (RH)
- 43.090 Setback Requirements for Conditional Uses (RH)
- 44.030 Conditional Uses Permitted (RH-HR)
- 44.050 Lot Size for Conditional Uses (RH-HR)
- 44.070 Setback Requirements for Conditional Uses (RH-HR)
- 49.030 Conditional Uses (IN)
- 49.040 Lot Size for Permitted and Conditional Uses (IN)
- 49.060 Setback Requirements for Conditional Uses (IN)
- 50.020 Permitted Uses (CO)
- 50.030 Central Urban Renewal Plan – Additional Permitted Uses and Conditional Uses (CO)
- 50.040 Conditional Uses (CO)
- 52.030 Conditional Uses (CR)
- 53.050 Conditional Uses (CC)
- 53.055 Central Urban Renewal Area – Conditional Uses (CC)
- 54.030 Conditional Uses (CG)
- 56.030 Conditional Uses (MC)
- 56.045 Lot Size for Conditional Uses (MC)
- 57.030 Conditional Uses (MUCOD)
- 60.040 Conditional Uses (ML)
- 60.041 Restrictions on Conditional Uses (ML)
- 61.030 Conditional Uses (MG)
- 61.031 Restrictions on Conditional Uses (MG)
- 62.030 Conditional Uses (MP)
- 62.031 Restrictions on Conditional Uses (MP)
- 64.030 Conditional Uses (MBP)
- 64.050 Lot Size for Permitted and Conditional Uses (MBP)
- 64.065 Setback Requirements for Conditional Uses (MBP)
- 68.030 Criteria for Designation of a Landmark
- 68.060 Demolition Criteria
- 68.070 Relocation Criteria
- 68.100 Alteration and New Construction Criteria
- 68.110 Alteration and New Construction Approval Process
- 73.130 Standards
- 73.160 Standards
- 73.190 Standards – Single-Family and Multi-Family Uses
- 73.220 Standards
- 73.227 Standards
- 73.230 Landscaping Standards
- 73.300 Landscape Standards – Multi-Family Uses
- 73.310 Landscape Standards – Commercial, Industrial, Public and Semi-Public Uses
- 73.320 Off-Street Parking Lot Landscaping Standards
- 73.470 Standards
- 73.500 Standards



CITY OF TUALATIN
Community Development Department-Planning Division
Land Use Application—Type II

PROPOSAL NAME Tualatin High School

PROPOSAL SUMMARY (Brief description)

The Tigard-Tualatin School District proposes a renovation and new construction of Tualatin High School to improve existing facilities. The renovation and new construction includes partial remodeling of the existing high school building and some additional landscaping and redevelopment of outdoor areas.

PROPERTY INFORMATION

Location (address if available): 22300 SW Boones Ferry Rd, Tualatin, OR 97062

Tax Map & Lot #(s): 2S135A000700 Planning District: None

Total site size: 64.68 acres Developed Undeveloped

APPLICANT/CONTACT INFORMATION

Applicant or Primary Contact Name: Tigard-Tualatin School District

Mailing Address: 6960 SW Sandburg Street

City/State: Tigard, Oregon Zip: 97223

Phone: 503-913-3777 Email: ckraus@DayCPM.com

Applicant's Signature: *Cathy Kraus* Date: 24 October '17

I hereby acknowledge that I have read this application and understand the requirements for approving and denying the application, that the information provided is correct, that I am the owner or authorized agent of the owner, and that plans submitted are in compliance with the City of Tualatin Development (TDC) and Municipal (TMC) Codes.

PROPERTY OWNER/DEED HOLDER INFORMATION (Attach list if more than one)

Name: Tigard-Tualatin School District; David Moore

Mailing Address: 6960 SW Sandburg Street

City/State: Tigard, Oregon Zip: 97223

Phone: 503 431-4000 Email: dmoore@ttsd.k12.or.us

Property Owner Signature: *David Moore* Date: 10/24/17

Power of attorney or letter of authorization required if application not signed by the property owner/deed holder.

LAND USE APPLICATION TYPE

- Architectural Review (AR)
- Historic Landmark (HIST)
- Interpretation (INT)
- Minor Variance (MVAR)
- Tree Removal (TCP)
- Other _____

FOR STAFF USE ONLY	
Case No.:	_____
Date Received:	_____
By:	_____
Fee Amount \$:	_____
Received by:	_____



CITY OF TUALATIN

Community Development Department-Planning Division

Land Use Application—Type II

PROPOSAL NAME Tualatin High School

PROPOSAL SUMMARY (Brief description)

The Tigard-Tualatin School District proposes a renovation and new construction of Tualatin High School to improve existing facilities. The renovation and new construction includes partial remodeling of the existing high school building and some additional landscaping and redevelopment of outdoor areas.

PROPERTY INFORMATION

Location (address if available): 22300 SW Boones Ferry Rd, Tualatin, OR 97062

Tax Map & Lot #(s): 2S135A000700 Planning District: None

Total site size: 60.5 Acres Developed Undeveloped

APPLICANT/CONTACT INFORMATION

Applicant or Primary Contact Name: Tigard-Tualatin Scholl District

Mailing Address: 6960 SW Sandburg Street

City/State: Tigard, Oregon Zip: 97223

Phone: 503-913-3777 Email: ckraus@DayCPM.com

Applicant's Signature: _____ Date: _____

I hereby acknowledge that I have read this application and understand the requirements for approving and denying the application, that the information provided is correct, that I am the owner or authorized agent of the owner, and that plans submitted are in compliance with the City of Tualatin Development (TDC) and Municipal (TMC) Codes.

PROPERTY OWNER/DEED HOLDER INFORMATION (Attach list if more than one)

Name: Tigard-Tualatin School District; David Moore

Mailing Address: 6960 SW Sandburg Street

City/State: Tigard, Oregon Zip: 97223

Phone: 503 431-4000 Email: dmoore@ttsd.k12.or.us

Property Owner Signature: _____ Date: _____

Power of attorney or letter of authorization required if application not signed by the property owner/deed holder.

LAND USE APPLICATION TYPE

- Architectural Review (AR) Minor Variance (MVAR)
- Historic Landmark (HIST) Tree Removal (TCP)
- Interpretation (INT) Other _____

FOR STAFF USE ONLY	
Case No.:	_____
Date Received:	_____
By:	_____
Fee Amount \$:	_____
Received by:	_____

GENERAL INFORMATION	
Site Address:	
Assessor's Map and Tax Lot #:	
Planning District:	
Parcel Size:	
Property Owner:	
Applicant:	
Proposed Use:	

ARCHITECTURAL REVIEW DETAILS	
Residential <input type="checkbox"/> Commercial <input type="checkbox"/> Industrial	
Number of parking spaces:	
Square footage of building(s):	
Square footage of landscaping:	
Square footage of paving:	
Proposed density (for residential):	

<p>For City Personnel to complete:</p> <p>Staff contact person:</p>
--

CITY OF TUALATIN FACT SHEET

General

Proposed use:			
Site area:	acres	Building footprint:	sq. ft.
Development area:	acres	Paved area:	sq. ft.
	Sq. ft.	Development area coverage:	%

Parking

Spaces required (see TDC 73.400) (example: warehouse @ 0.3/1000 GFA) _____ @ _____ /1000 GFA = _____ _____ @ _____ /1000 GFA = _____ _____ @ _____ /1000 GFA = _____ Total parking required: _____ spaces ADA accessible = _____ Van pool = _____ Compact = (max. 35% allowed) = Loading berths = _____	Spaces provided: Total parking provided: _____ spaces Standard = _____ ADA accessible = _____ Van pool = _____ Compact = _____ Loading berths = _____
--	---

Bicycles

Covered spaces required:	Covered spaces provided:
--------------------------	--------------------------

Landscaping

Landscaping required: _____% of dvpt. area Square feet	Landscaping provided: _____% of dvpt. area Square feet
Landscaped parking island area required: _____%	Landscaped parking island area provided: _____%

Trash and recycling facility

Minimum standard method:	square feet
Other method:	_____ square feet

For commercial/industrial projects only

Total building area:	sq. ft.	2 nd floor:	sq. ft.
Main floor:	sq. ft.	3 rd floor:	sq. ft.
Mezzanine:	sq. ft.	4 th floor:	sq. ft.

For residential projects only

Number of buildings:	Total sq. ft. of buildings:	sq. ft.
Building stories:		



Water supply modeling is necessary for larger projects to determine the impact of the project’s water demand on the water supply system. Water supply modeling will be performed by a consulting engineer based on the most recent version of the Tualatin Water System Master Plan.

Due to possible impacts to the water supply system, the following projects in Tualatin require hydraulic modeling based on the size and type of the project and projected water use for the finished project. The outcome of modeling could require offsite improvements to the water supply system in order to ensure that adequate water supply is available to serve the project and reduce impacts to the overall system.

Hydraulic modeling of the water supply system is required for the following project type/sizes/demand:

Project Type	Criteria	Permit Fee
Commercial or Industrial Building	Building floor area greater than 48,300 square feet or Anticipated daily water demand greater than 870 gallons per acre per day	\$ 300 per building
Residential development	More than 49 dwelling units	\$ 1,000
Multi-family development	More than 49 dwelling units or a combined building floor area greater than 48,300 square feet	\$ 300 per building

Please complete this form and submit the form and required fee (if applicable) with your land-use application (architectural review, subdivision, etc.).

Commercial or Industrial Development

- Building floor area _____ square feet
- Anticipated water demand (if known) _____ gallons per day
- Described planned building use _____

Residential Development

- Number of dwelling units or single family home lots _____

Multi-Family Residential Development

- Number of dwelling units _____
- Building floor area (sum of all building) _____
- Number of multi-family buildings _____

Permit fee required based on the information provided above \$ _____

- If no fee is required, enter \$0.

NOTE: Water Supply Modeling does not replace the requirement for fire hydrant flow testing. Flow testing of fire hydrants will still be required to verify adequate fire flow of finished system

ARCHITECTURAL REVIEW CERTIFICATION OF SIGN POSTING

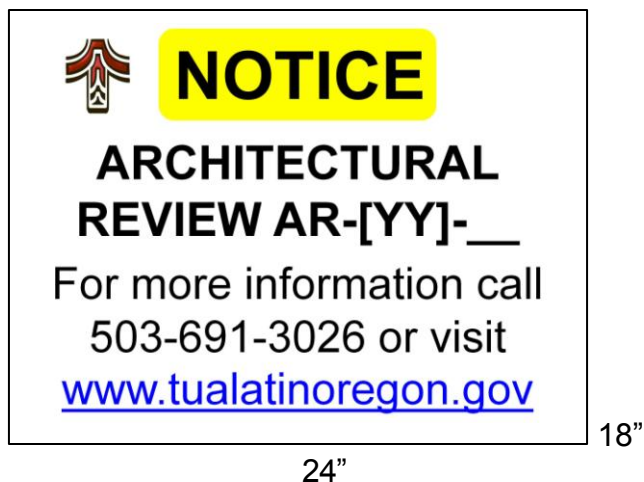

The applicant shall provide and post a sign pursuant to Tualatin Development Code (TDC) 31.064(2). Additionally, the 18" x 24" sign must contain the application number, and the block around the word "NOTICE" must remain **primary yellow** composed of the **RGB color values Red 255, Green 255, and Blue 0**. Additionally, the potential applicant must provide a flier (or flyer) box on or near the sign and fill the box with brochures reiterating the meeting info and summarizing info about the potential project, including mention of anticipated land use application(s). Staff has a Microsoft PowerPoint 2007 template of this sign design available through the Planning Division homepage at < www.tualatinoregon.gov/planning/land-use-application-sign-templates>.

NOTE: For larger projects, the Community Development Department may require the posting of additional signs in conspicuous locations.

As the applicant for the _____ project, I hereby certify that on this day, _____ sign(s) was/were posted on the subject property in accordance with the requirements of the Tualatin Development Code and the Community Development Department - Planning Division.

Applicant's Name: _____
(PLEASE PRINT)

Applicant's Signature: _____

Date: _____

	LABEL TEMPLATE / EXAMPLE	
	2S123BC02000 PROPERTY OWNER'S NAME ADDRESS CITY STATE ZIP	

TUALATIN HIGH SCHOOL / SITE PLAN

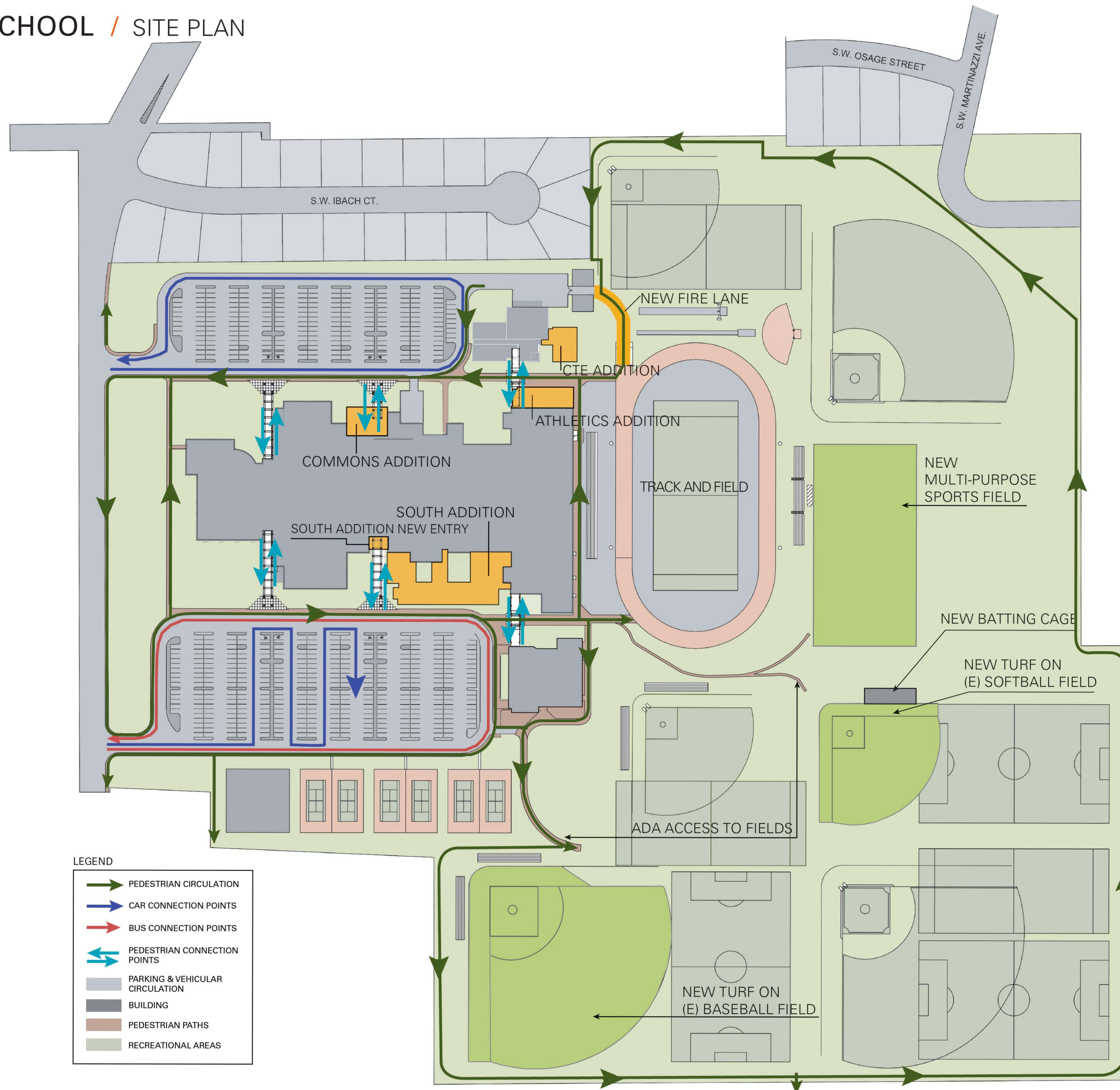

TUALATIN HIGH SCHOOL RENOVATIONS AND ADDITIONS

22300 SW BOONES FERRY ROAD
TUALATIN, OREGON, WASHINGTON COUNTY



V Y

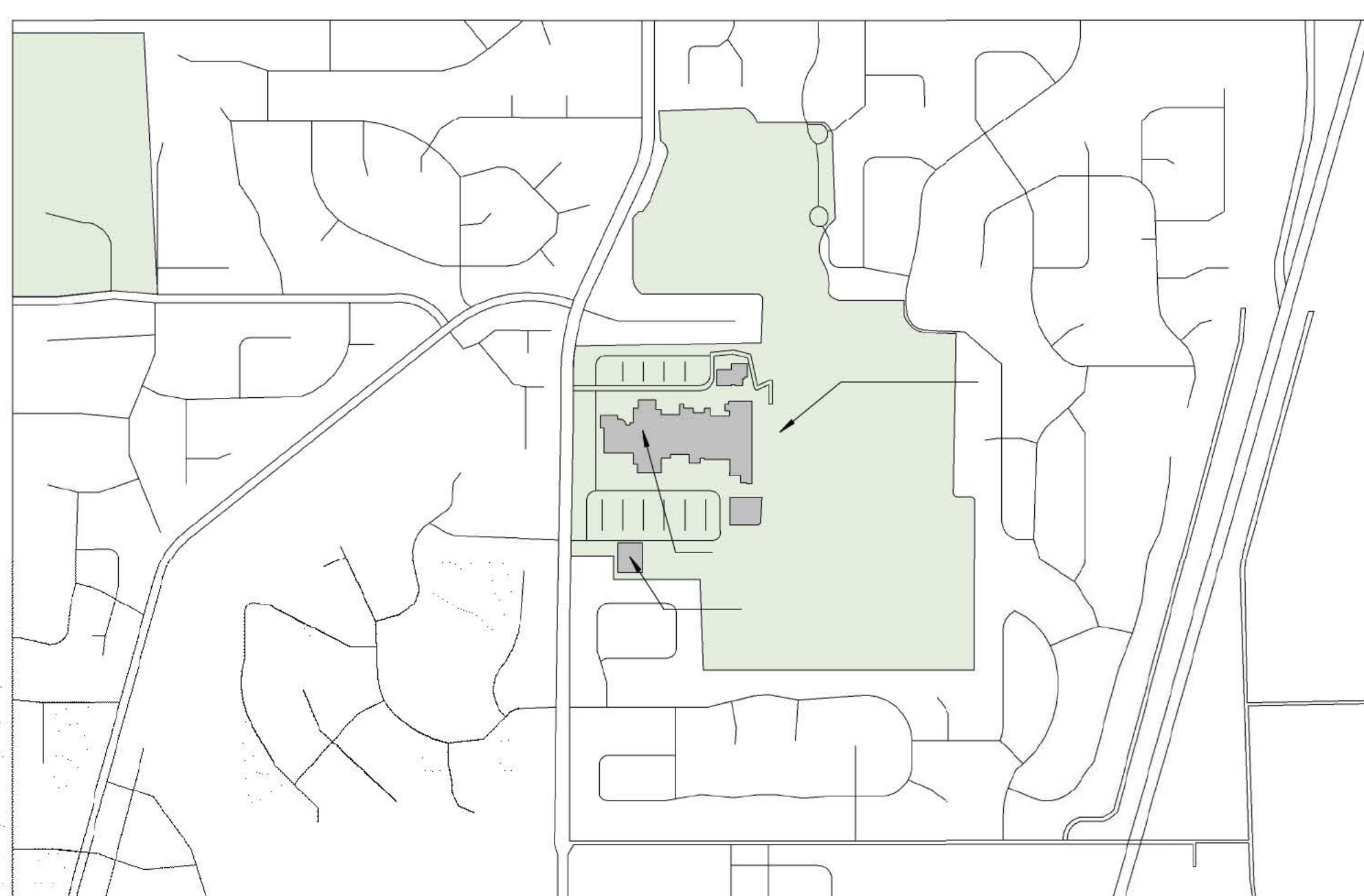

S
S S B V S
S
S S Y S S V
S S V S S
S S V

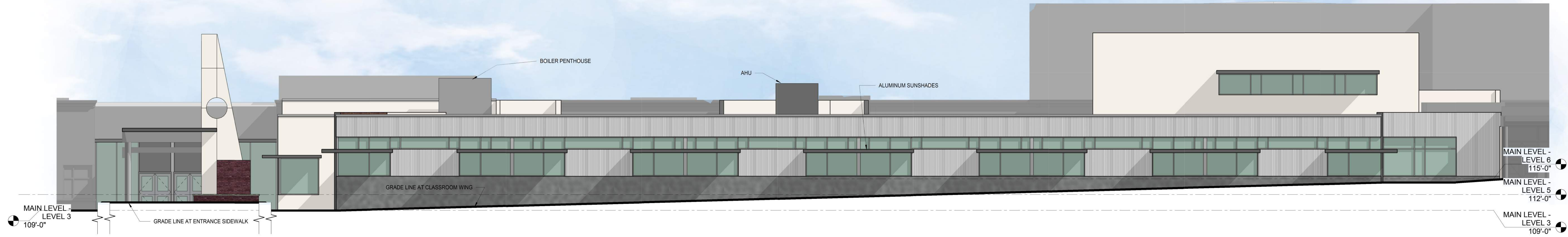

1 SOUTH ADDITION - SOUTH ELEVATION - LU
1/8" = 1'-0"

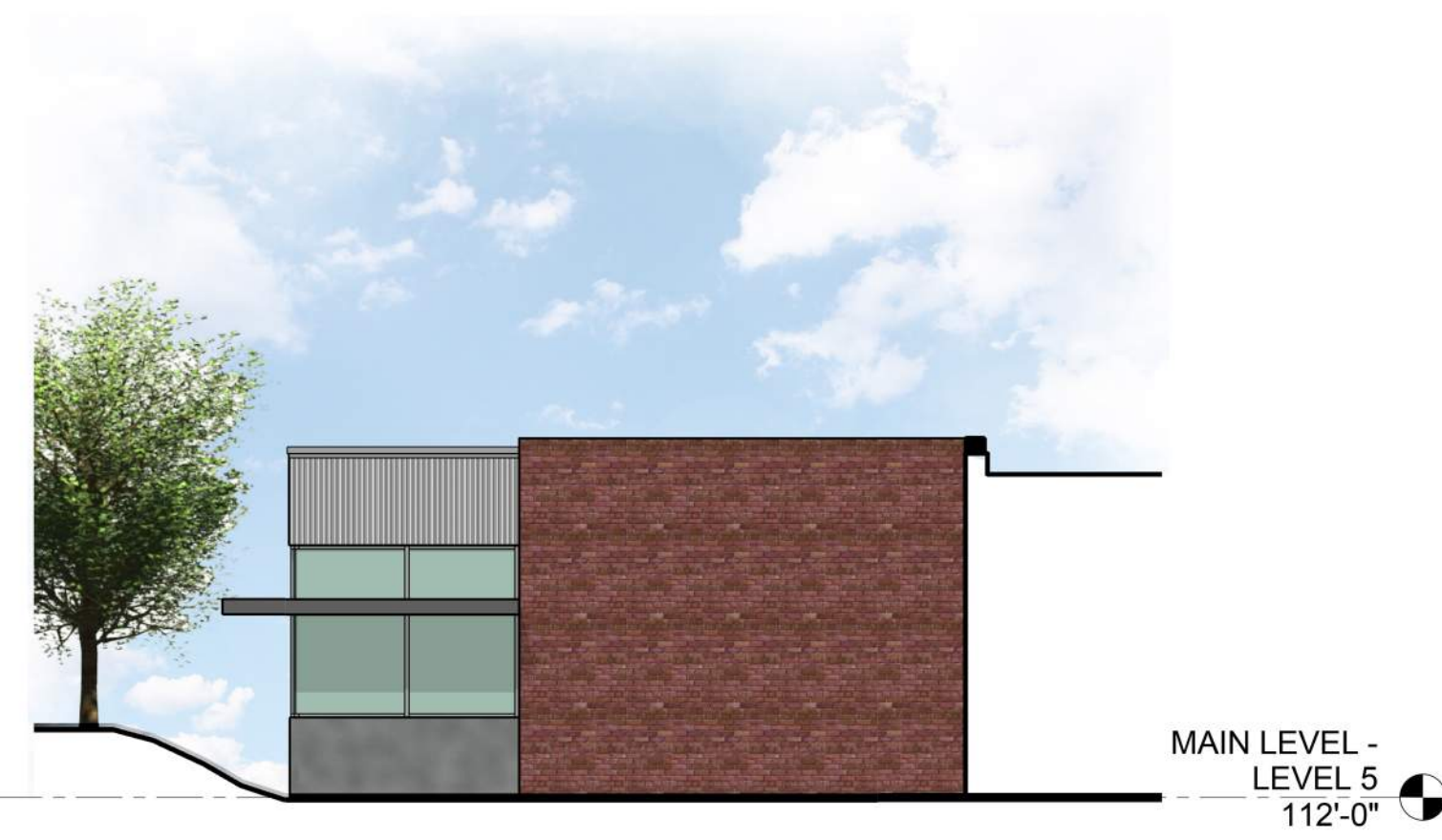

3 SOUTH ADDITION - EAST ELEVATION LU
1/8" = 1'-0"



2 SOUTH ADDITION - WEST ELEVATION LU
1/8" = 1'-0"

TUALATIN HIGH SCHOOL
RENOVATIONS AND ADDITIONS

#	REVISIONS	DATE
1		
2		
3		
4		
5		

Owner
Tualatin High School

22300 SW Boones Ferry Road
Tualatin, Oregon, Washington County
97062
JOB NO: 16993
ISSUE DATE: 12/13/17
Jurisdiction Stamp Area

	MWP-METAL PANEL SYSTEM		BRICK VENEER SYSTEM
	STUCCO		EXISTING BUILDING

ELEVATION LEGEND

LANDUSE

OVERALL
BUILDING
ELEVATIONS

LU 1.00

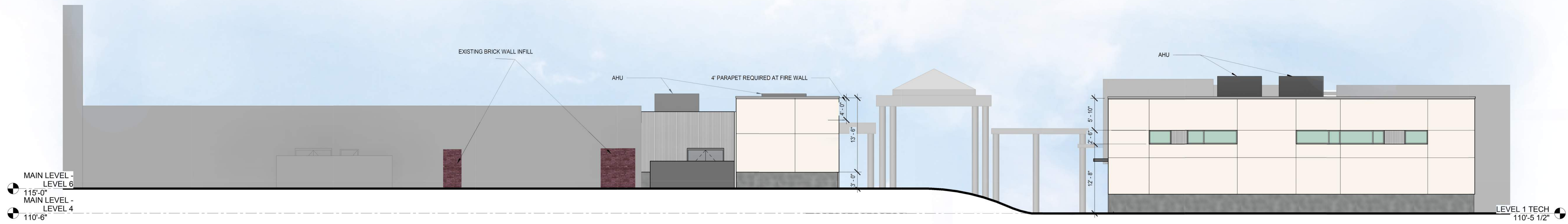

1 LOCKER ROOM ADDITION - EAST ELEVATION LU
1/8" = 1'-0"



2 CTE ADDITION - NORTH ELEVATION LU
1/8" = 1'-0"

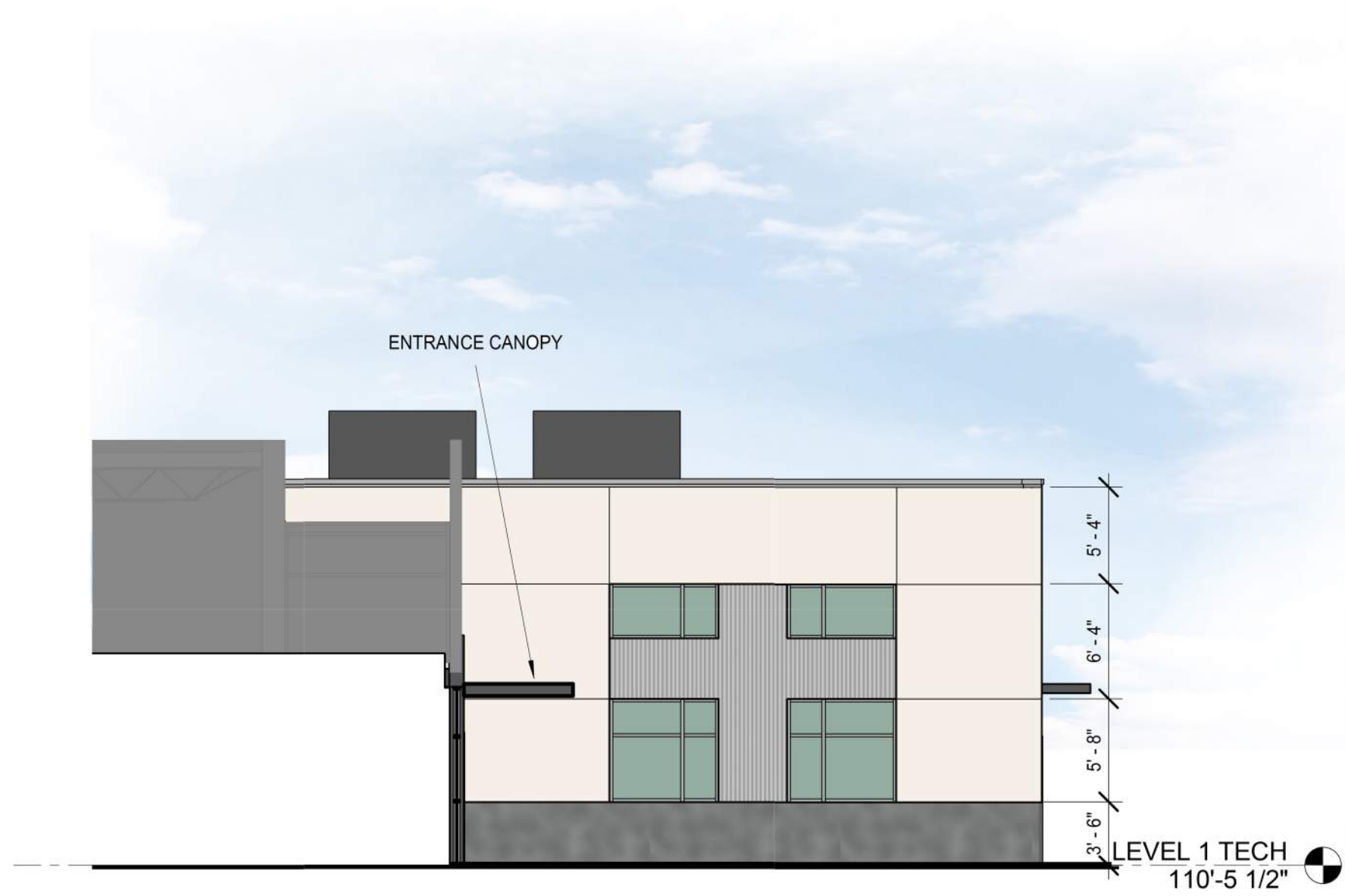

4 CTE ADDITION - WEST ELEVATION LU
1/8" = 1'-0"



3 CTE ADDITION - SOUTH ELEVATION LU
1/8" = 1'-0"

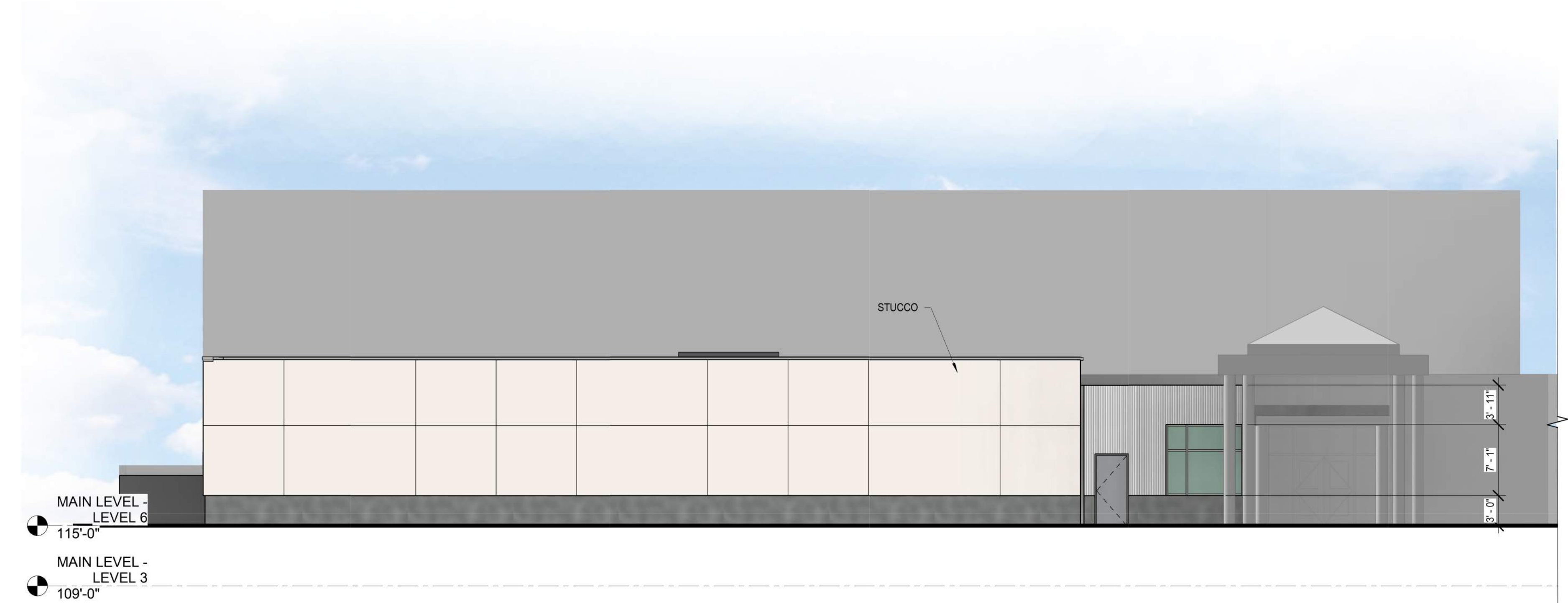

5 LOCKER ROOM AND COMMONS ADDITION - NORTH ELEVATION LU
1/8" = 1'-0"

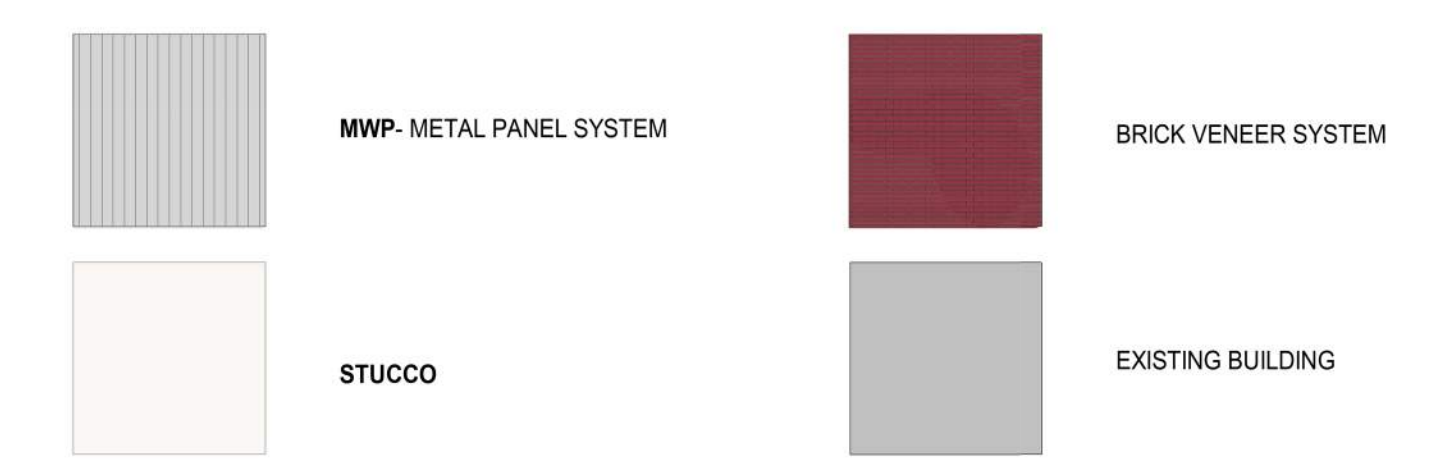

ELEVATION LEGEND

#	REVISIONS	DATE
1		
2		
3		
4		
5		

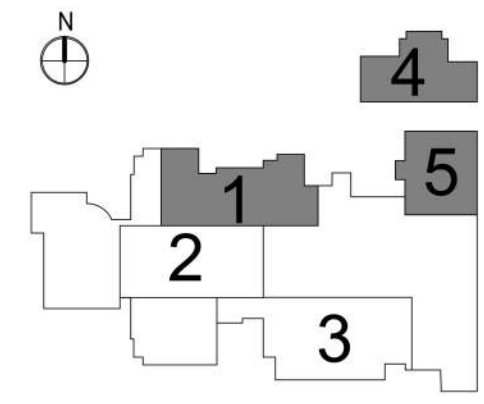

Owner
Tualatin High School

22300 SW Boones Ferry Road
Tualatin, Oregon, Washington County
97062
JOB NO: 16993
ISSUE DATE: 12/13/17
Jurisdiction Stamp Area

OVERALL
BUILDING
ELEVATIONS

LU 2.00

LANDUSE

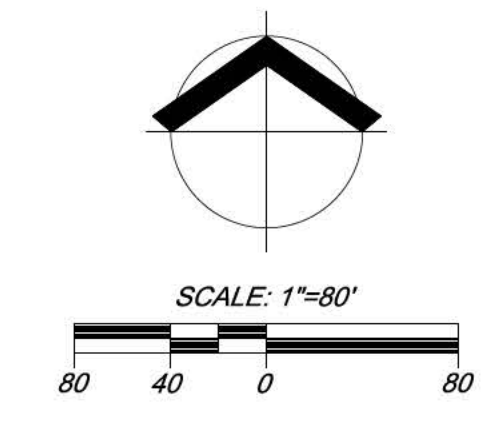
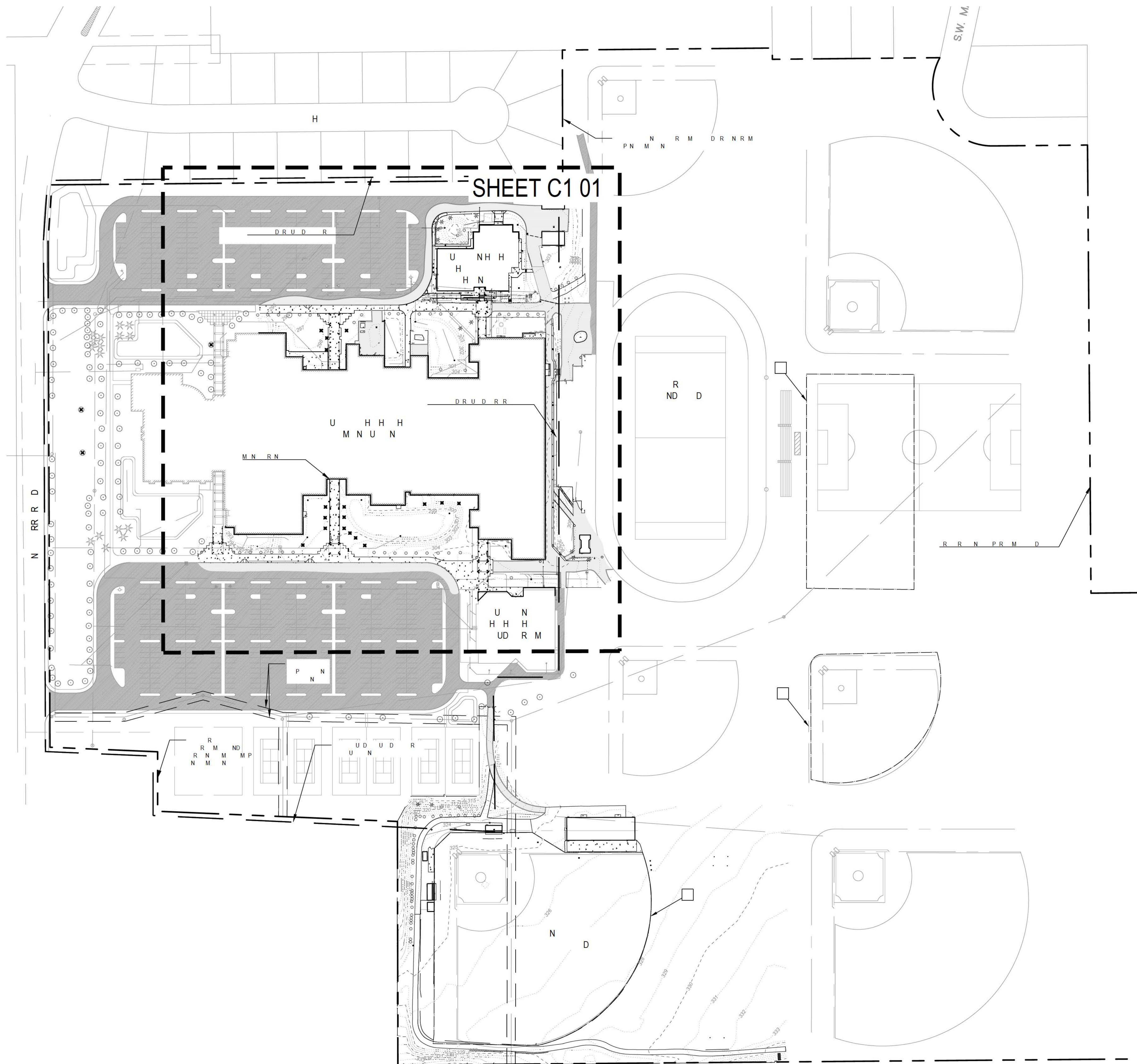

---	U N
---	U N R N N
---	N M R N R
---	N M R R N R
---	M P R H UR
---	U N
---	N H R
---	N N R UR
---	N R M H
---	N R R U
---	H N
---	R
---	R ND H
---	H H N
---	R H N N
---	N N N NU
---	N N NU U
---	H D P R N P
---	P
---	N PR N
---	N H R
---	M D
---	N N UR
---	M D
---	N R R
---	M D
---	R D R
---	M D
---	R D R
---	R D R
---	R R U R U N R R N
---	R P D N H UR D
---	R R N P R M D
---	R R N P R M D

DESCRIPTION	EXISTING		PROPOSED		(+/-) INCREASE (-) DECREASE
	QUANTITY	UNIT	QUANTITY	UNIT	
PERVIOUS AREA					
LANDSCAPING (SITE)	390,451	SF	364,593	SF	-25,858
LANDSCAPING (PARKING LOT)	19,857	SF	19,857	SF	0
TOTAL PERVIOUS AREA	410,308	SF	384,450	SF	-25,858
IMPERVIOUS AREA					
PAVEMENT (IMPERVIOUS AREA)	308,708	SF	308,708	SF	0
BUILDING AREA	235,620	SF	261,478	SF	25,858
TOTAL IMPERVIOUS AREA	544,328	SF	570,186	SF	25,858
DEVELOPMENT AREA*	954,636	SF	954,636	SF	0
TOTAL AREA	954,636	SF	954,636	SF	0
PERCENTAGE OF LANDSCAPE AREA*	43	%	40	%	3

NOTES:
 *SEE PLAN FOR DEVELOPMENT AREA DELINEATION
 **REQUIRED PERCENTAGE OF LANDSCAPE IS 25%

DESCRIPTION	NUMBER OF STALLS	SF
ADA PARKING STALLS	24	3456
ADA LOADING STRIPS	12	1728
STANDARD PARKING STALLS	591	95742
TOTAL PARKING STALLS	615	99630

ASSUMPTIONS:
 ALL NON-ADA STALLS ARE ASSUMED TO BE STANDARD STALLS (9' X 18').

bassetti architects

721 NW 9TH Ave, Suite 350
 Portland, Oregon 97209
 T (206) 340 9500 F (206) 340 9519

CIVIL ENGINEER & LANDSCAPE
 Cardno
 6720 SW Macadam Ave, Suite 200
 Portland, OR 97219
 T (503) 419-2500

STRUCTURAL ENGINEER
 Catena Engineers
 1111 NE Flinders St, Suite 206
 Portland, OR 97232
 T (503) 467-4980

MECHANICAL ELECTRICAL & PLUMBING ENGINEER
 Glumac
 900 SW Fifth Ave., Suite 1600
 Portland, OR 97204
 T (503) 227-6280

FOOD SERVICE CONSULTANT
 Webb Foodservice Design
 3700 SE Lafayette Ct.
 Portland, OR 97202
 T (503) 236-8566

COST CONSULTANT
 Construction Focus
 740 Ahmदन St.
 Eugene, OR 97402
 T 541-686-2031

PORTLAND
Cardno
 Shaping the Future
 6720 SW MACADAM AVE, STE 200, PORTLAND, OR 97219
 TEL: (503) 419-2500 FAX: (503) 419-2500
 www.cardno.com

**TUALATIN HIGH SCHOOL
 RENOVATIONS AND ADDITIONS**

DATE _____

TIGARD TUALATIN SD
**TUALATIN
 HIGH
 SCHOOL**

22300 SW BOONES FERRY RD.
 TUALATIN, OR 97062

JOB NO: 21612290
 ISSUE DATE: 12/13/17

**EXISTING
 CONDITIONS
 PLAN**

C1.00

LANDUSE

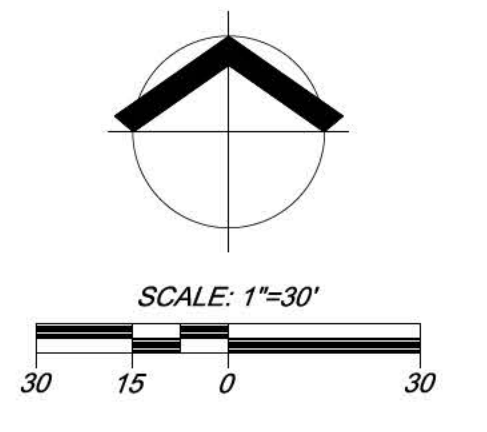

TUALATIN HIGH SCHOOL
RENOVATIONS AND ADDITIONS

DATE

TIGARD TUALATIN SD
**TUALATIN
HIGH
SCHOOL**

22300 SW BOONES FERRY RD.
TUALATIN, OR 97062

JOB NO: 21612290
ISSUE DATE: 12/13/17
S

**EXISTING
CONDITIONS -
NORTH**

C1.01

LANDUSE

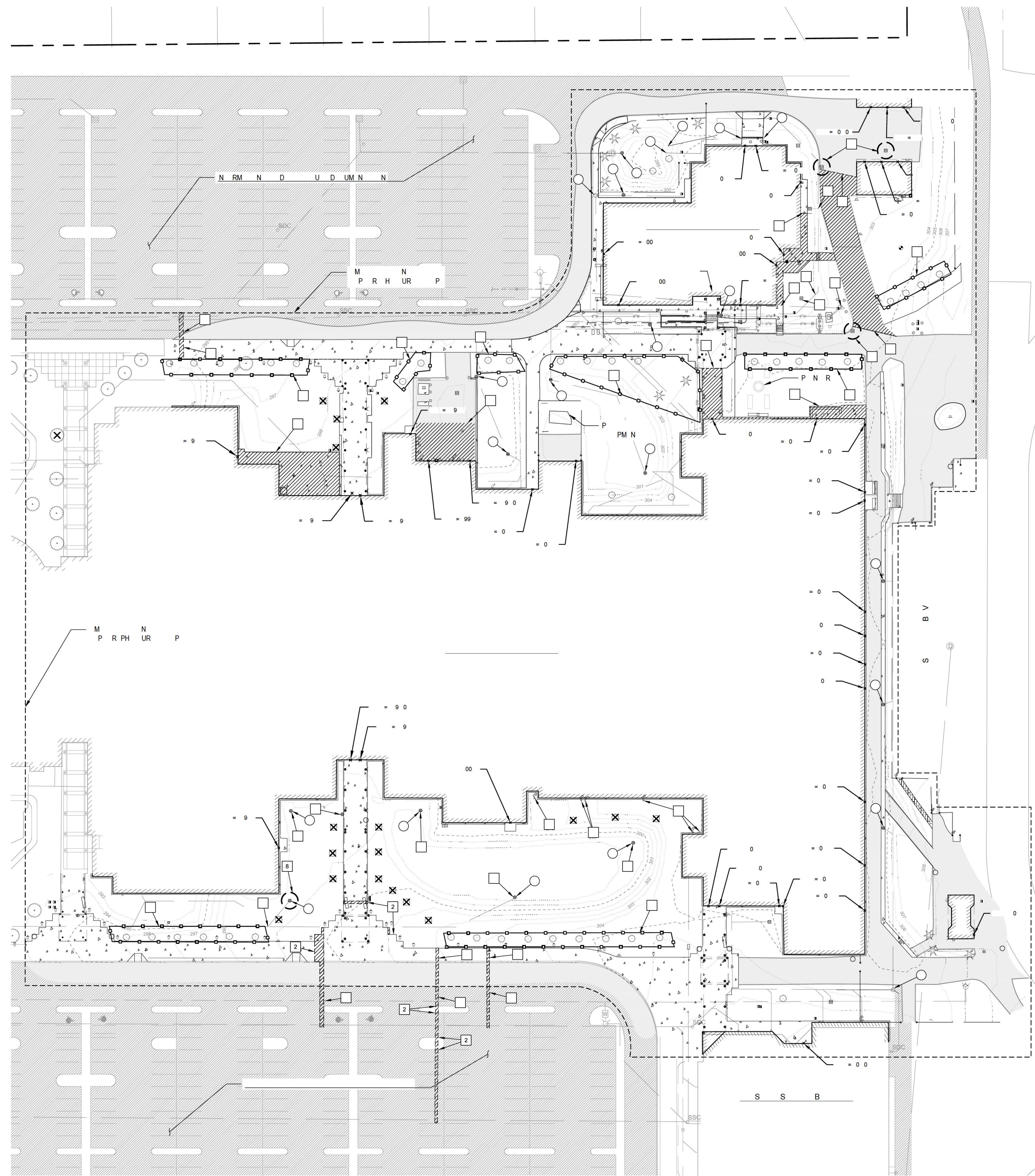

N D	
---	U N H N N
---	N M R N UR
---	N R R N UR
---	M P PH R
---	U N
---	N H UR
---	N R R R
---	N R RM H
---	N R R NU
---	H N
---	R
---	R D H
---	H H N
---	R H UN N
---	N N N NU
---	N N U U
---	ND P P N P
---	NP
---	N R N
---	R M D UR
---	N R D R
---	R M D
---	N R UR
---	R M D

PR P D D	
---	R R N N N R
---	R R NP N
---	N R RM D
---	R R R P N

RM R N					
○	M D N	○	M D N	○	M R N
○	M N	○	R D R R N	○	M R N
○	UP	○	M P P	○	M
○	R D N	○	MP	○	R R N
○	M N	○	ND U	○	M
○	M P	○	P	○	R R N
○	M N	○	ND U	○	R R N
○	P N	○	P	○	M
○	R D N	○	R N		
○	M	○	R N		
○	M D N	○	M D N		
○	M D N	○	M D N		
○	M D N	○	M D N		
○	M H R N	○	M D N		
○	M	○	R N		
○	N M R	○	NH		
○	U P R	○	M		
○	U P	○	P N		
○		○	P		
○		○	MP		

□	U D M R H M N N D
□	P D M R H M N N D
□	U D M R N R UR D
□	R D M R N M N N N
□	N R R R N N H D N
□	R R P N
□	M DR N R H R N H
□	RRP H R N N
□	N R D N M R M P P D
□	R R P N N N
□	P D D
□	P R N R U D N U U D P M R
□	P D D N N R D N R NP
□	N N R N N R DR N

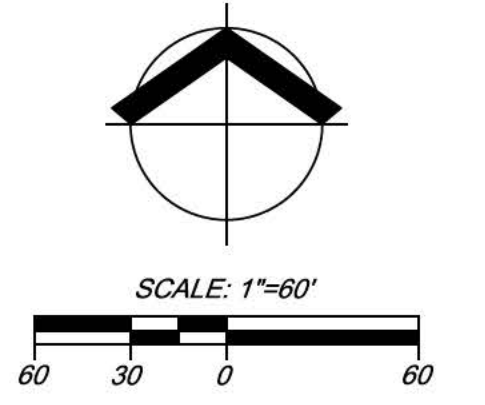
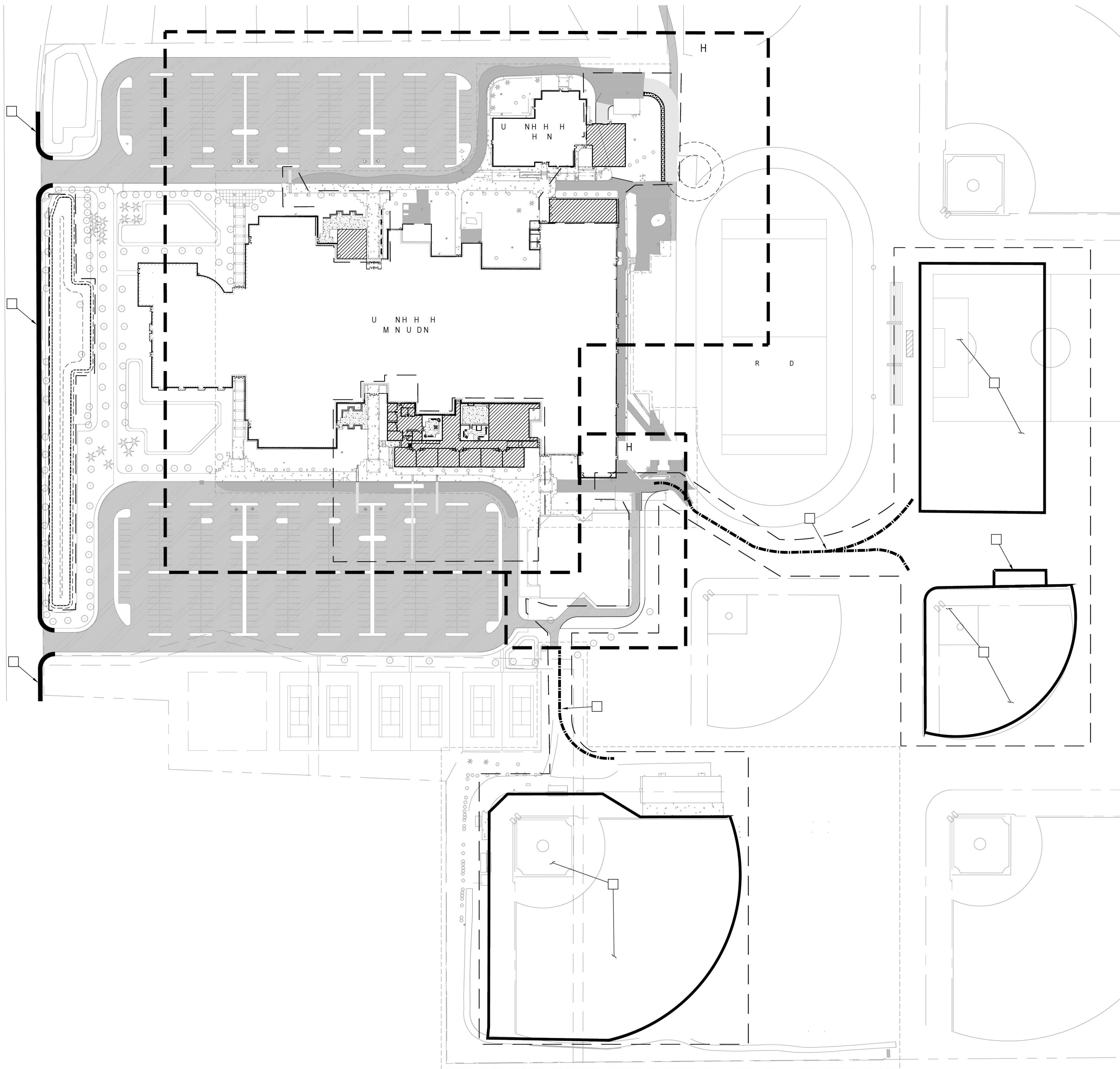

[Symbol]	R N
[Symbol]	P M N UR
[Symbol]	R R
[Symbol]	NR UR
[Symbol]	RM R
[Symbol]	DR N D H
[Symbol]	R P H UR
[Symbol]	P P D DN D N
[Symbol]	M R N R
[Symbol]	MNR N R
[Symbol]	M PR MNR
[Symbol]	R D DR N
[Symbol]	R D DR N

[Symbol]	R P D	M R	M N N
[Symbol]	D D DR P ND	N N N MP N	R N D MN M R R N U
[Symbol]	RP D U P P	N H	R D
[Symbol]	RP D	H UR	D
[Symbol]	RP D	H UR	D
[Symbol]	RP D	N D R	
[Symbol]	RP DD	PR	



721 NW 9TH Ave, Suite 350
Portland, Oregon 97209
T (206) 340 9500 F (206) 340 9519

CIVIL ENGINEER & LANDSCAPE
Cardno
6720 SW Macadam Ave., Suite 200
Portland, OR 97219
T (503) 419-2500

STRUCTURAL ENGINEER
Catena Engineers
1111 NE Flinders St., Suite 206
Portland, OR 97232
T (503) 467-4980

MECHANICAL ELECTRICAL & PLUMBING ENGINEER
Glumac
900 SW Fifth Ave., Suite 1600
Portland, OR 97204
T (503) 227-6280

FOOD SERVICE CONSULTANT
Webb Foodservice Design
3700 SE Lafayette Ct.
Portland, OR 97202
T (503) 236-8566

COST CONSULTANT
Construction Focus
740 Ahaden St.
Eugene, OR 97402
T 541-686-2031



**TUALATIN HIGH SCHOOL
RENOVATIONS AND ADDITIONS**

#	DATE

**TIGARD TUALATIN SD
TUALATIN
HIGH
SCHOOL**

22300 SW BOONES FERRY RD.
TUALATIN, OR 97062

JOB NO: 21612290
ISSUE DATE: 12/13/17
S

SITE PLAN

C2.00

LANDUSE

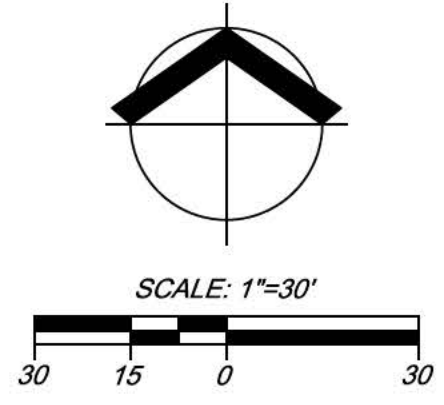
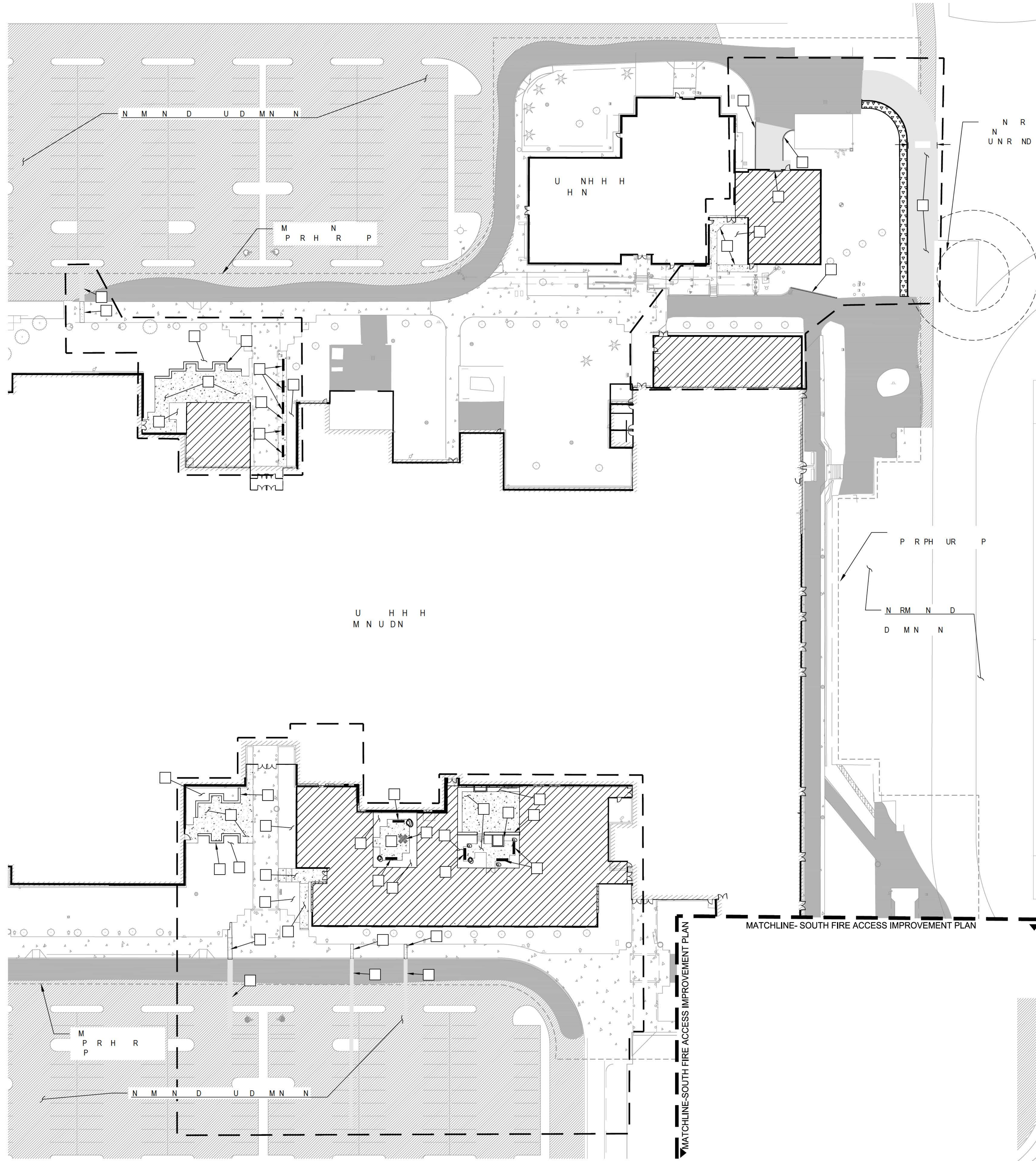

PR	P	D	ND				
□	□	□	□	P N UR			
□	□	□	□	R R			
□	□	□	□	NR R			
□	□	□	□	RM R			
□	□	□	□	R N D H			
□	□	□	□	R H UR			
□	□	□	□	R P D D N D N			
□	□	□	□	M R N R			
□	□	□	□	NR N R			
□	□	□	□	M PR M N R			
PR	P	D	PR	M	N	N	
□	□	□	□	□	□	□	P P D H D D P R R
□	□	□	□	□	□	□	P P N R H D D N H R U R N H D R
□	□	□	□	□	□	□	P P D N R UR P D R N D N
□	□	□	□	□	□	□	P P D N H H N R
□	□	□	□	□	□	□	P P D P D R R R R N
□	□	□	□	□	□	□	N D N P N P N
□	□	□	□	□	□	□	N P P D N R
□	□	□	□	□	□	□	P P D N R R M R N H N
□	□	□	□	□	□	□	P P D H R DR R N N
□	□	□	□	□	□	□	P P D R P N D H DR
□	□	□	□	□	□	□	P P R N

DATE

TIGARD TUALATIN SD
TUALATIN HIGH SCHOOL

22300 SW BOONES FERRY RD.
TUALATIN, OR 97062

JOB NO: 21612290
ISSUE DATE: 12/13/17
S

SITE PLAN
NORTH

C2.01

LANDUSE

TUALATIN HIGH SCHOOL
RENOVATIONS AND ADDITIONS



SCALE: 1"=20'

[Symbol]	R N
[Symbol]	P M N R
[Symbol]	R R
[Symbol]	N R U R
[Symbol]	R M R
[Symbol]	D N D H
[Symbol]	R P H R
[Symbol]	P P U D N D N
[Symbol]	M R N R
[Symbol]	M R N R
[Symbol]	M P R M N R
[Symbol]	P P D N
[Symbol]	N N

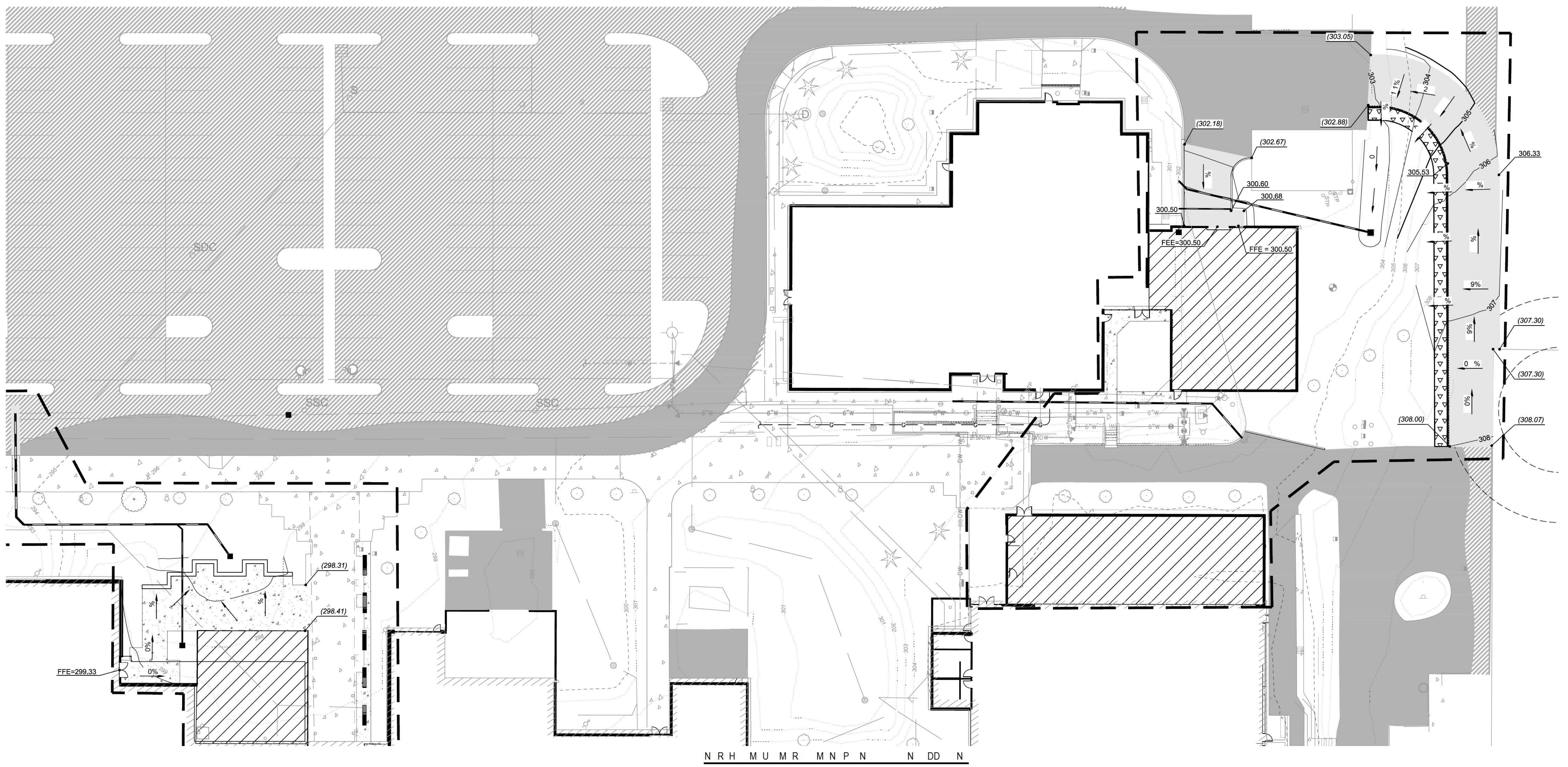

N R H M U M R M N P N N D D N

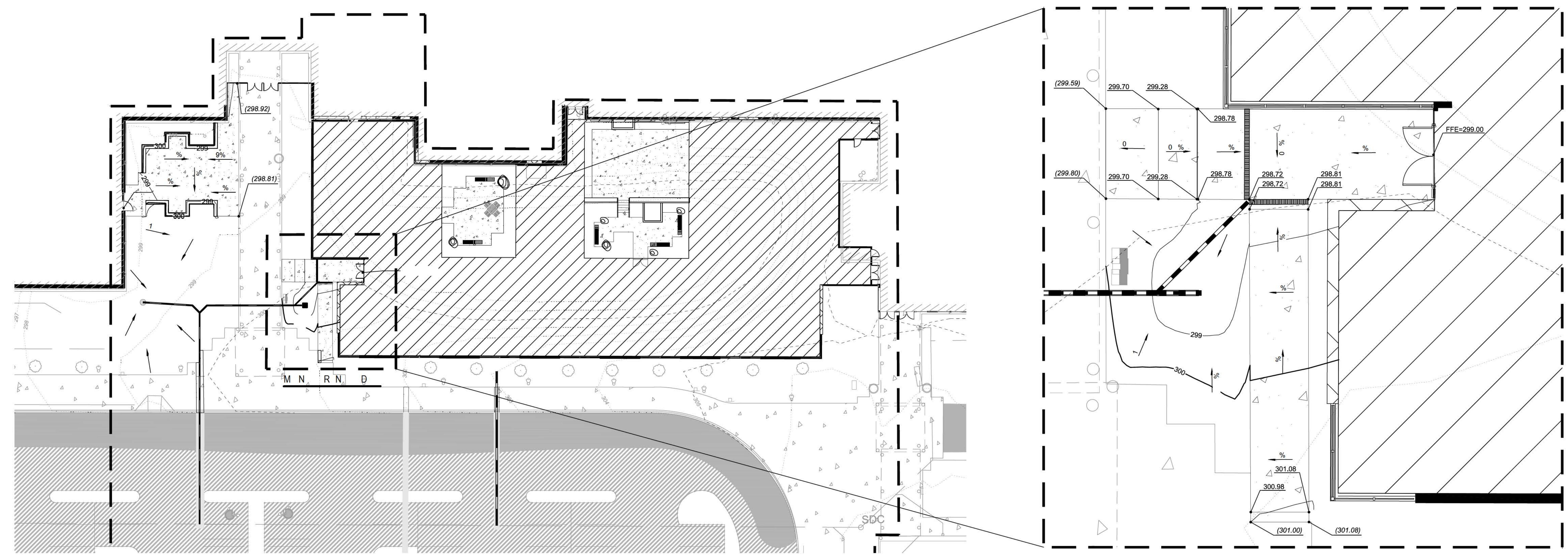

N R H M U P R M N P N M N R N D

[Symbol]	DATE
----------	------

TIGARD TUALATIN SD
TUALATIN
HIGH
SCHOOL

22300 SW BOONES FERRY RD.
TUALATIN, OR 97062

JOB NO: 21612290
ISSUE DATE: 12/13/17
S

GRADING PLAN
NORTH

C3.00

LANDUSE

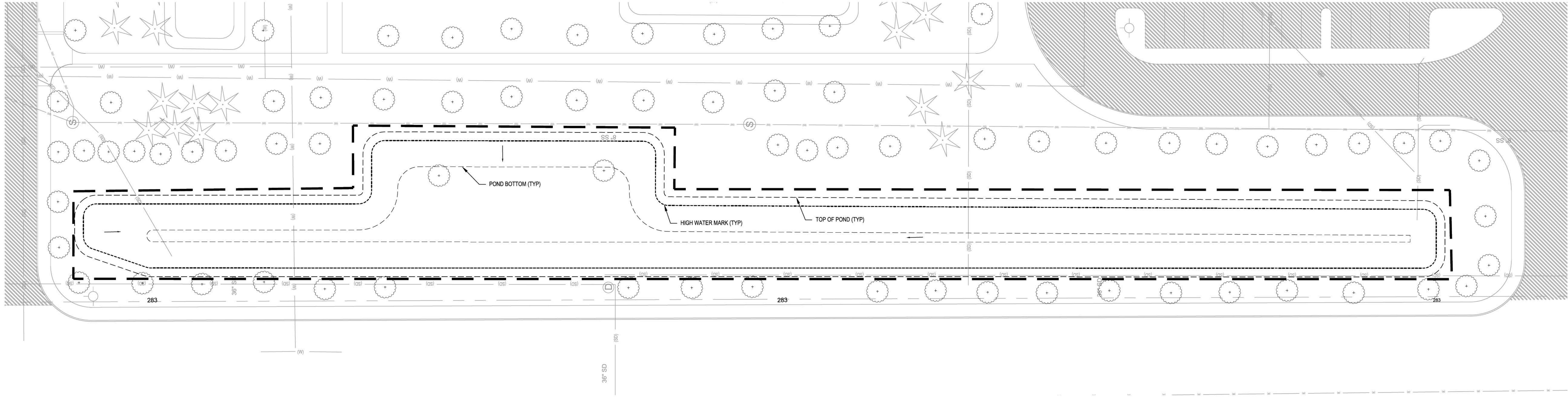
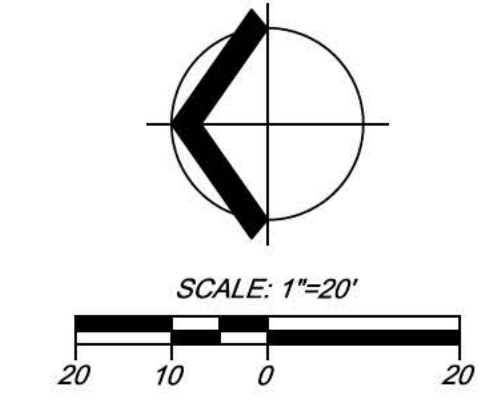

R P D M P N D R D N

TUALATIN HIGH SCHOOL
RENOVATIONS AND ADDITIONS

DATE

TIGARD TUALATIN SD
**TUALATIN
HIGH
SCHOOL**

22300 SW BOONES FERRY RD.
TUALATIN, OR 97062

JOB NO: 21612290
ISSUE DATE: 12/13/17

STORMWATER
POND GRADING

C3.01

LANDUSE

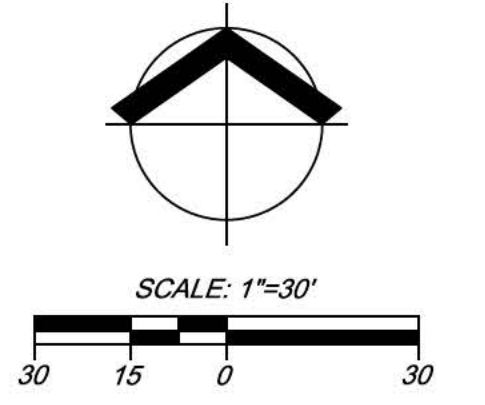
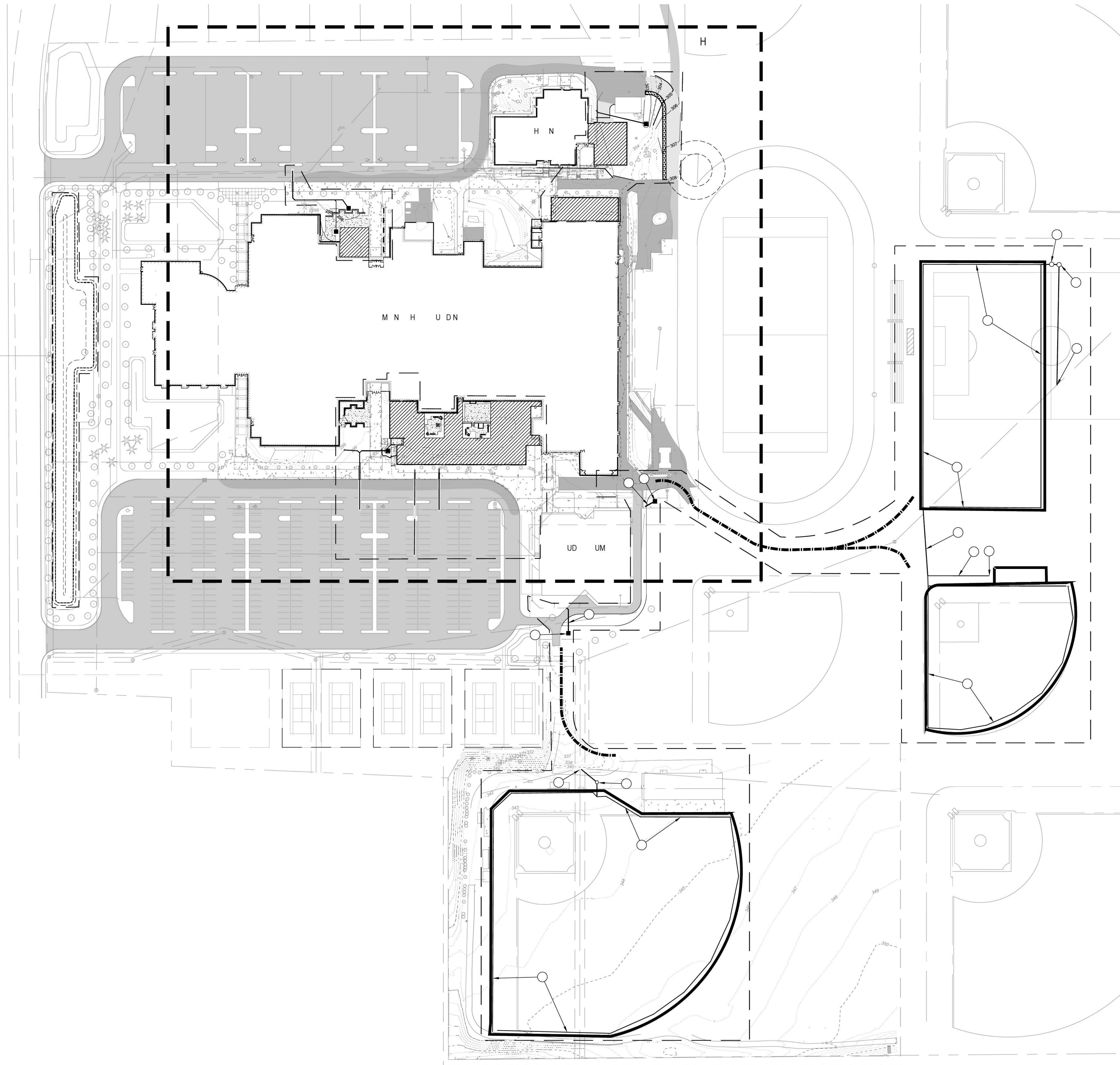

R	P	D	D
[Solid Grey]	[White]	[Dotted]	[Diagonal Lines]
R N	P N UR	N R R	M R
	R R	N R R	R N D H
		R P H UR	R P D D N D N
		M R N R	N R N R
		M	M R M N R

○	N	R	D	P	P	M	R	N
○	N		N	R	N	H		
○	N	R	M	N	N	H		
○	N	P	R	M	N			
○	N	P	R	M	N			
○	N	P	R	M	N			
○	N	R	R	N				
○	N	M	R	H	N			
○	NN		N	P	U	M	R	N
○	NN		U	N	R	D	N	

bassetti architects
 721 NW 9TH Ave, Suite 350
 Portland, Oregon 97209
 T (206) 340 9500 F (206) 340 9519

CIVIL ENGINEER & LANDSCAPE
Cardno
 6720 SW Macadam Ave., Suite 200
 Portland, OR 97219
 T (503) 419-2500

STRUCTURAL ENGINEER
Catena Engineers
 1111 NE Flinders St., Suite 206
 Portland, OR 97232
 T (503) 467-4980

MECHANICAL ELECTRICAL & PLUMBING ENGINEER
Glumac
 900 SW Fifth Ave., Suite 1600
 Portland, OR 97204
 T (503) 227-6280

FOOD SERVICE CONSULTANT
Webb Foodservice Design
 3700 SE Lafayette Ct.
 Portland, OR 97202
 T (503) 236-8566

COST CONSULTANT
Construction Focus
 740 Ahmadien St.
 Eugene, OR 97402
 T 541-686-2031

Cardno
 Shaping the Future
 PORTLAND
 6720 SW MACADAM AVE, STE 200, PORTLAND, OR 97219
 TEL: (503) 419-2500 FAX: (503) 419-2600
 www.cardno.com

**TUALATIN HIGH SCHOOL
 RENOVATIONS AND ADDITIONS**

#	DATE

**TIGARD TUALATIN SD
 TUALATIN HIGH SCHOOL**

22300 SW BOONES FERRY RD.
 TUALATIN, OR 97062

JOB NO: 21612290
 ISSUE DATE: 12/13/17
 S

**COMPOSITE
 UTILITY PLAN**

C4.00

LANDUSE

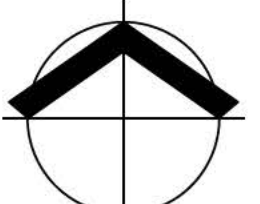

SCALE: 1"=30'

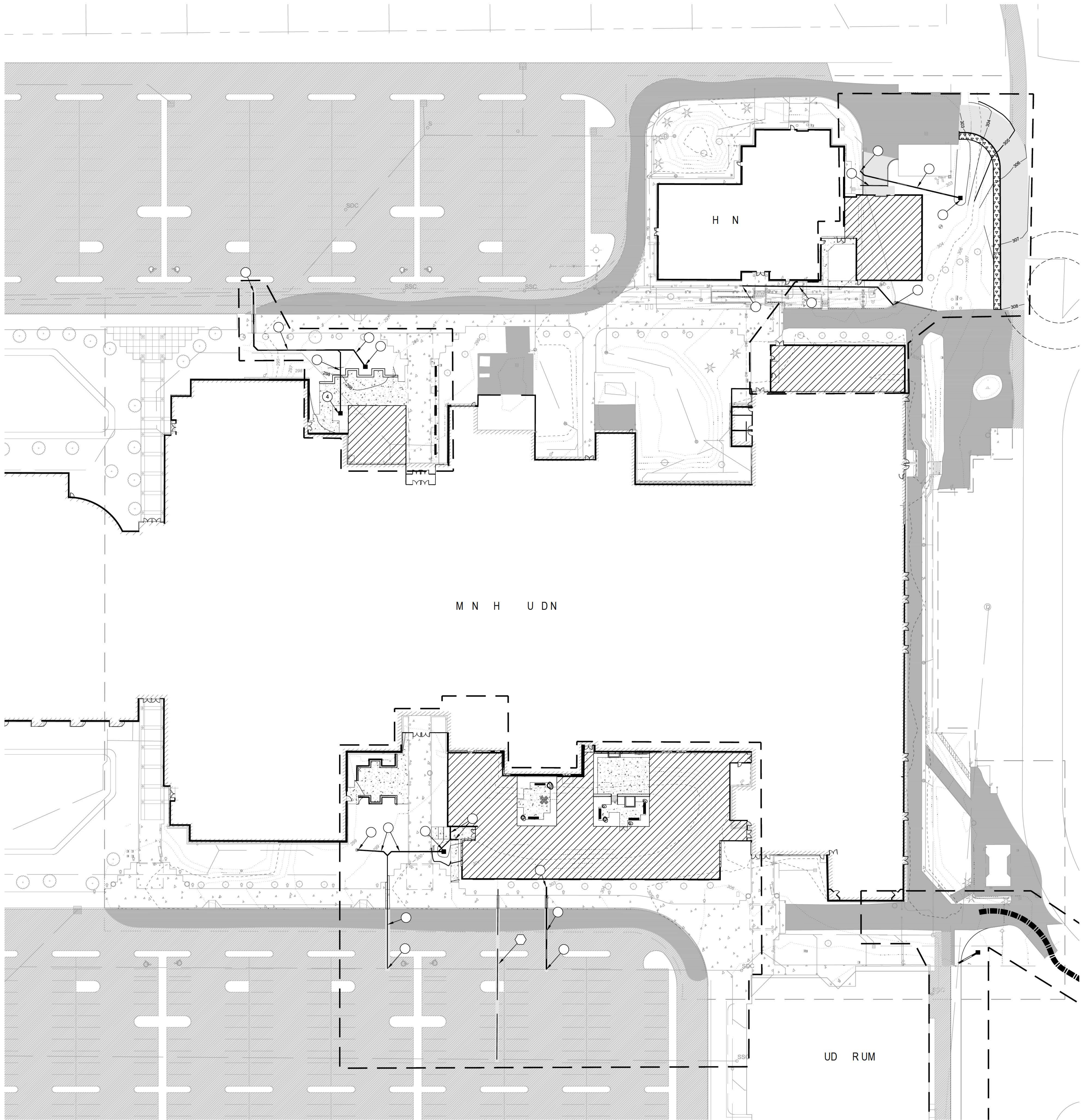
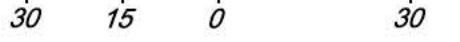

R	P	D	D

	N	R	H	R	D	N	N	N	M	P	N
	NN	N	H	N	PR	P	DR	N			
	NN	R	P	D	M	N	N	P	N		RM
	N	R	R	N							
	R	M	N		R	DR	N	U	R	DD	R
	N										
	N	P									
	N										
	NN	N	R	R	N	P	P	D	M	N	

	N	R									
	N	N	H	N	R	R	R	N	N		

TUALATIN HIGH SCHOOL
RENOVATIONS AND ADDITIONS

#	DATE

TIGARD TUALATIN SD
**TUALATIN
HIGH
SCHOOL**

22300 SW BOONES FERRY RD.
TUALATIN, OR 97062

JOB NO: 21612290
ISSUE DATE: 12/13/17

**COMPOSITE
UTILITY PLAN
NORTH**

C4.01

LANDUSE

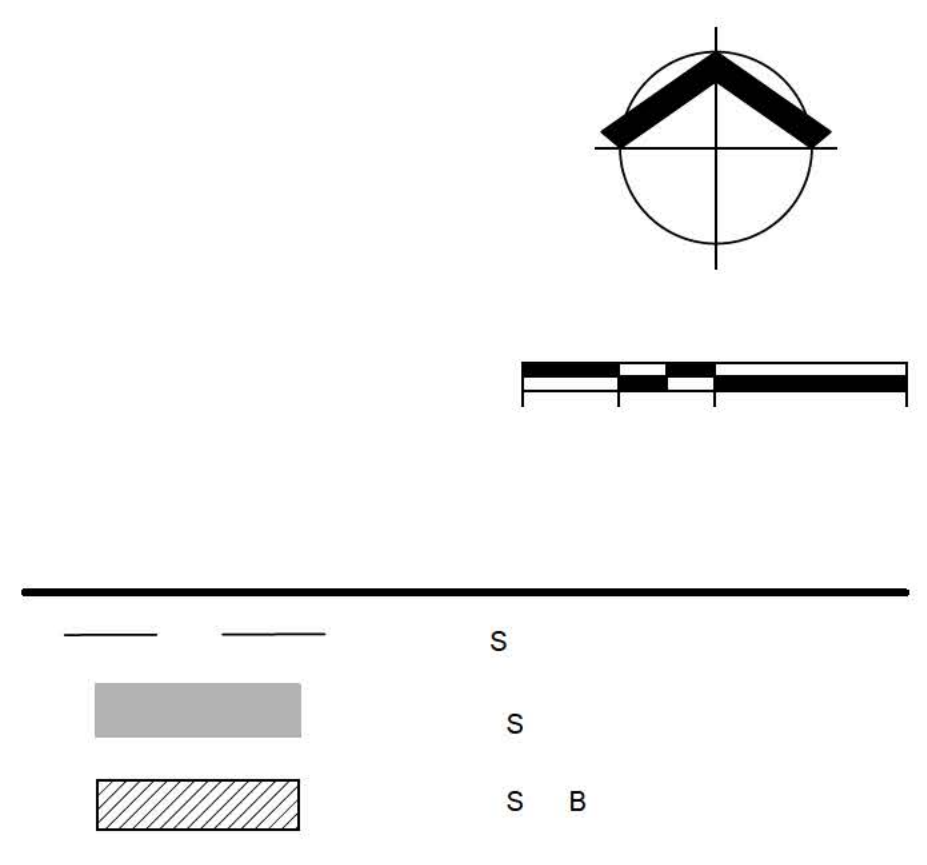
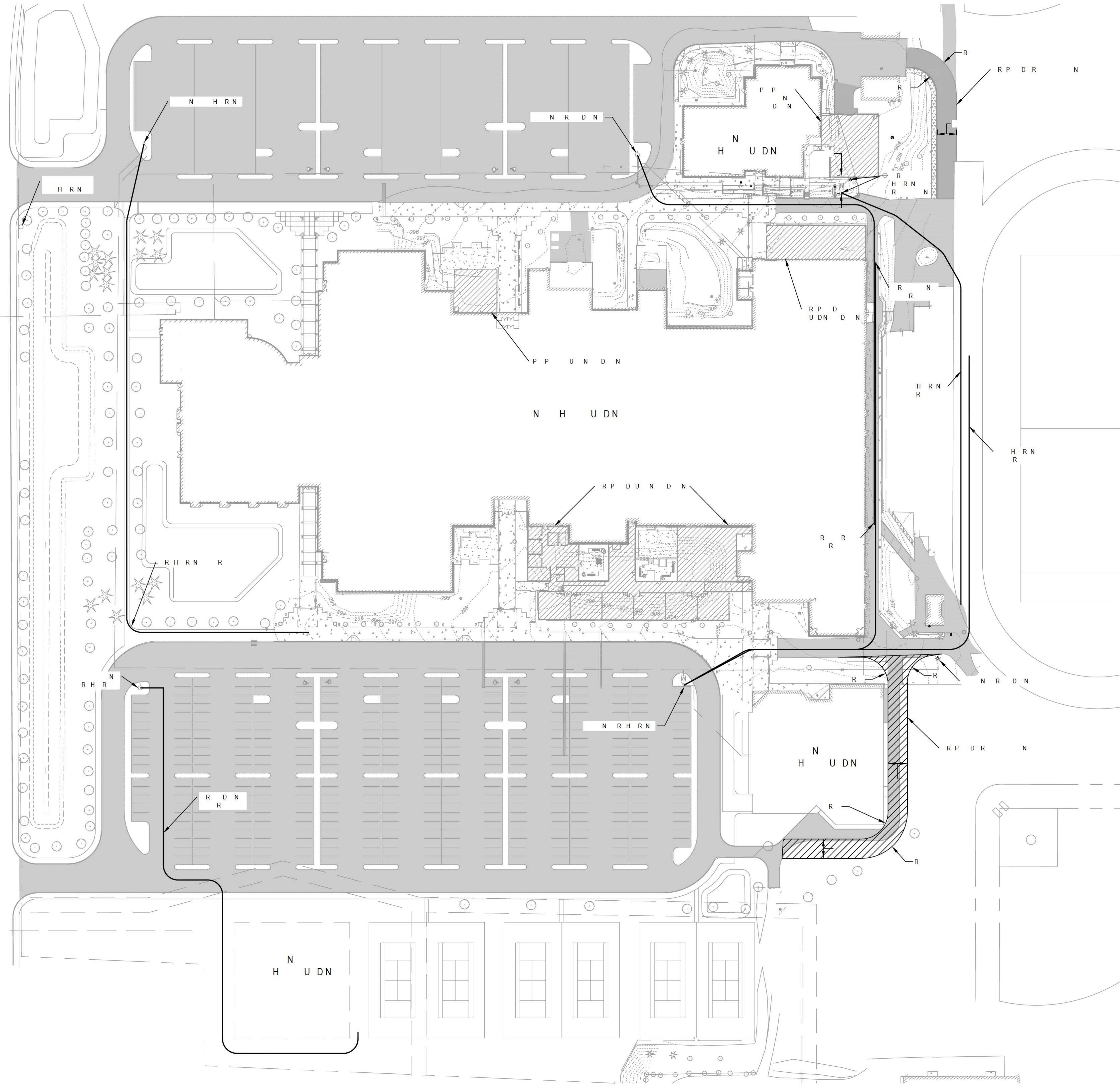

TUALATIN HIGH SCHOOL
RENOVATIONS AND ADDITIONS

DATE

TIGARD TUALATIN SD
**TUALATIN
HIGH
SCHOOL**

22300 SW BOONES FERRY RD.
TUALATIN, OR, 97062

JOB NO: 21612290
ISSUE DATE: 12/13/17

EXTERNAL FIRE
ACCESS AND
SERVICE

C5.00

LANDUSE

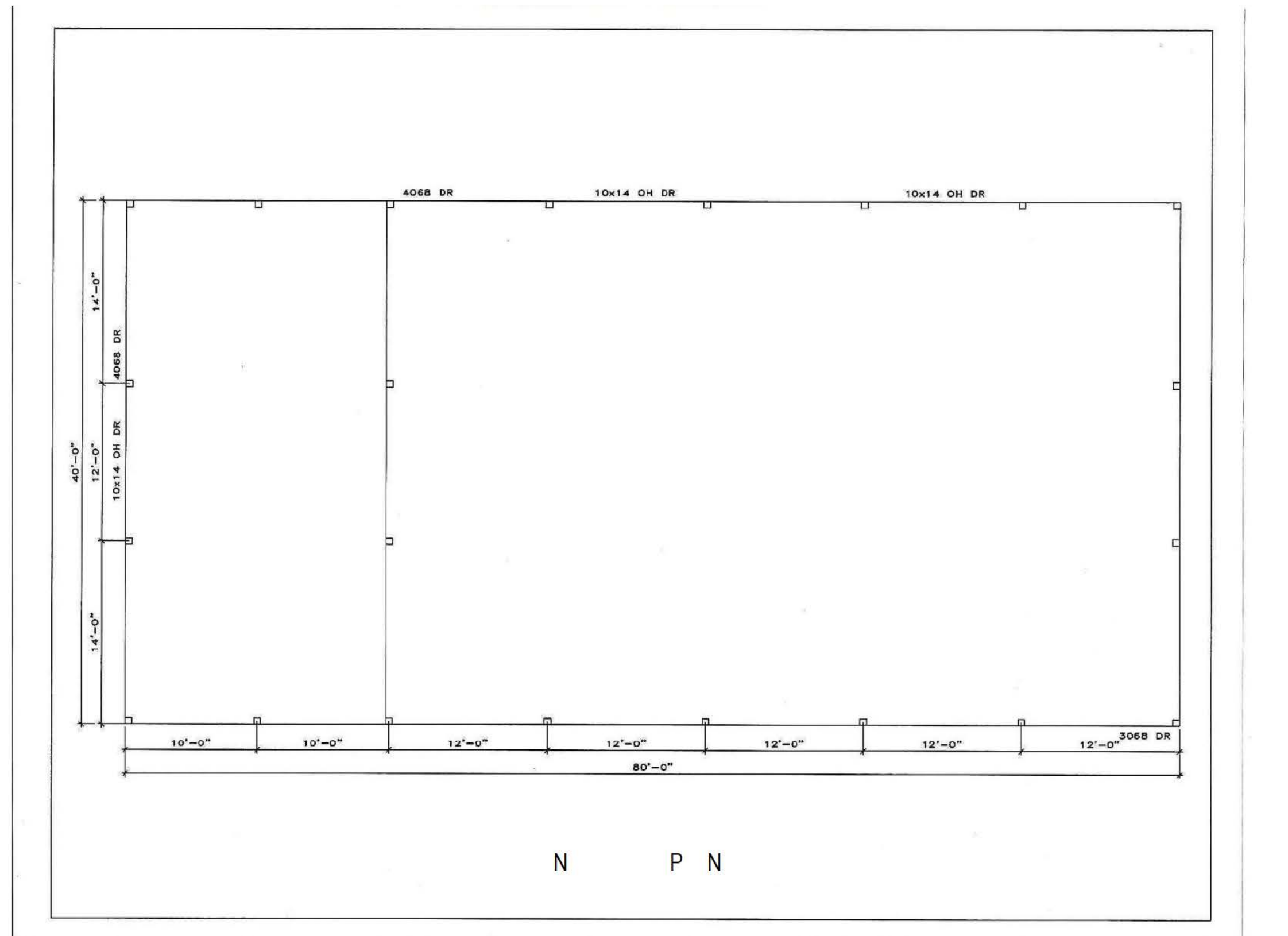
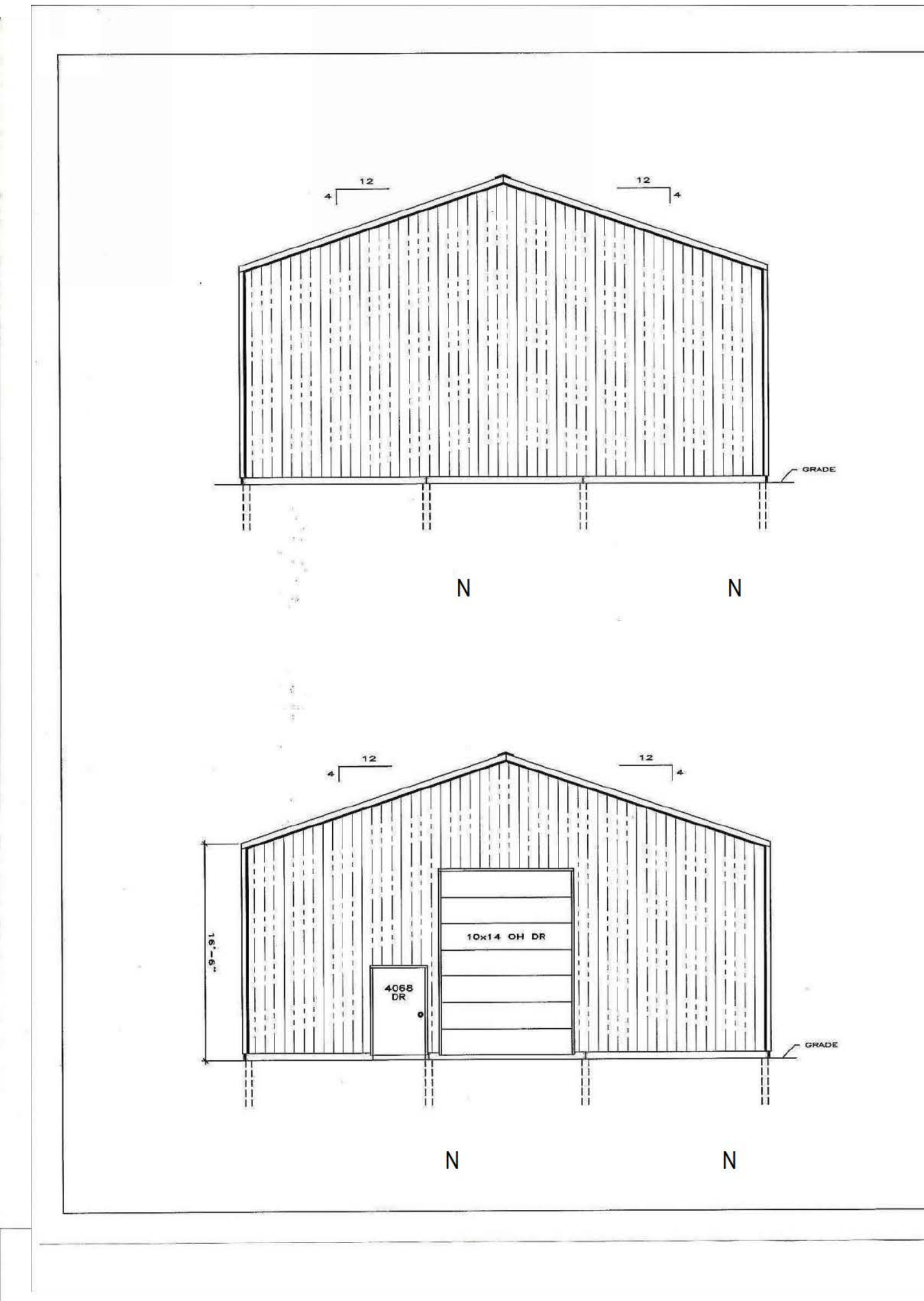
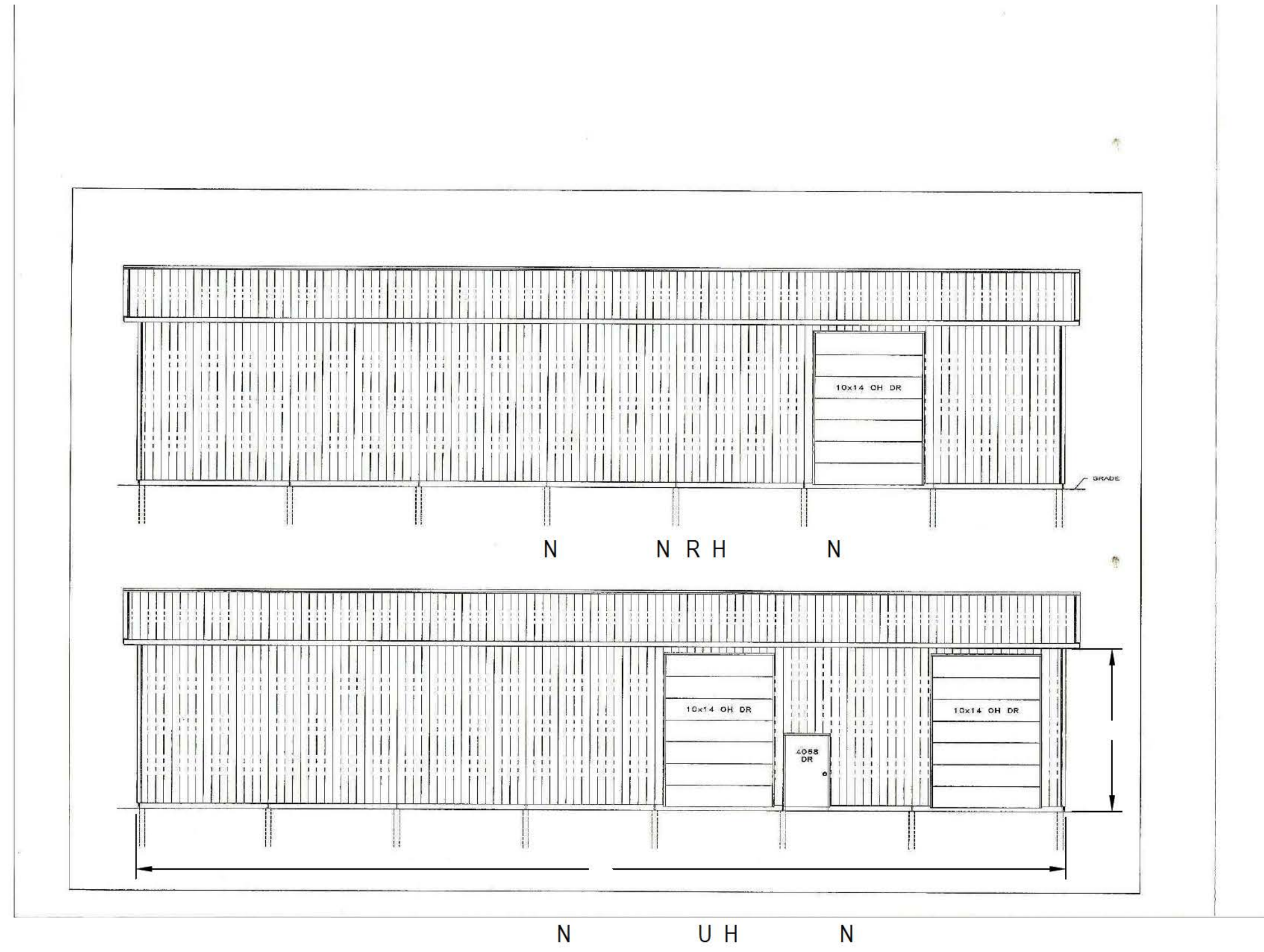

14Aug2017 Welcome to M&W Building Supply Co.

M&W BUILDING SUPPLY CO.

M&W BUILDING SUPPLY CO 22175 S. HWY 99E CANBY, OREGON 97013 TEL:1-800-547-1714

Steps to choosing your building color online

Home | Specialty | Options | Brochure | Colors | F.A.Q'S | Site Prep. | Referrals

Sales | Contact us

M&W BUILDING SUPPLY CO.
P.O. Box 220 • 22175 S. Hwy. 99E • Canby, OR 97013
• CUSTOM POLE BUILDINGS •

Phone: 800-547-1714 Website: www.mwbsc.com

Glacier White SRP-70	Stone White SRP-71	Island SRP-72	Light Stone SRP-58
Sandstone SRP-68	Hickory SRP-69	Steering Grey SRP-63	Charcoal Grey SRP-25
Pacific Blue SRP-26	Tahiti Blue SRP-26	Sea Green SRP-31	Forest Green SRP-22
Cocoa Brown SRP-27	Weathered Copper SRP-25	Kodiak Brown SRP-22	Pine Green SRP-22
Fire Red SRP-33	Galvalume/ Zincalume	Galvalume/ Zincalume	Galvalume/ Zincalume

http://www.mwbsc.biz/mwbsc_res/mwbsc_new4/mwbsc_coloring.html 1/2

TUALATIN HIGH SCHOOL
RENOVATIONS AND ADDITIONS

DATE

TIGARD TUALATIN SD
**TUALATIN
HIGH
SCHOOL**
22300 SW BOONES FERRY RD.
TUALATIN, OR. 97062

JOB NO: 21612290
ISSUE DATE: 12/13/17
S

BATTING CAGE

LANDUSE

BC1.00

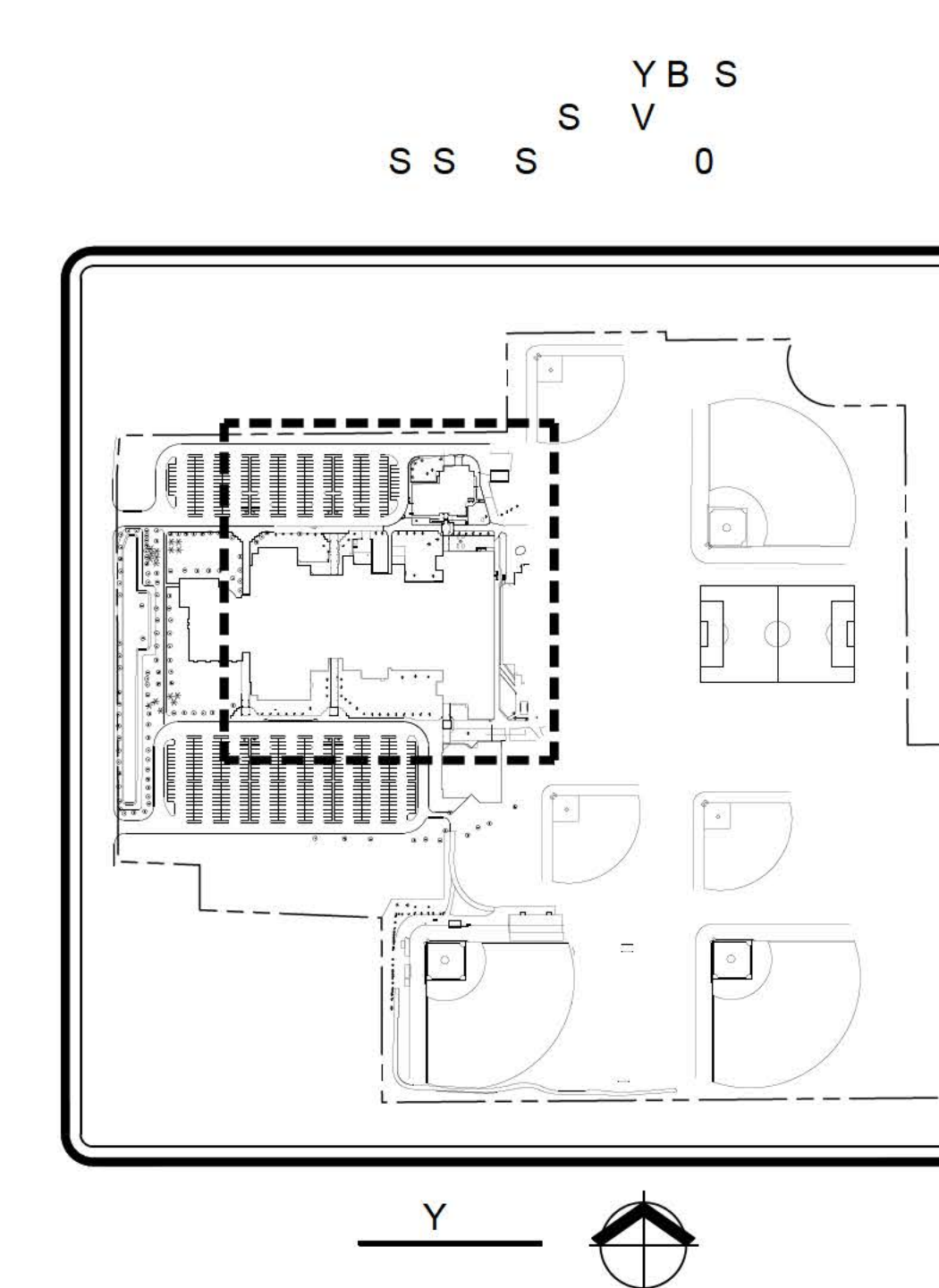
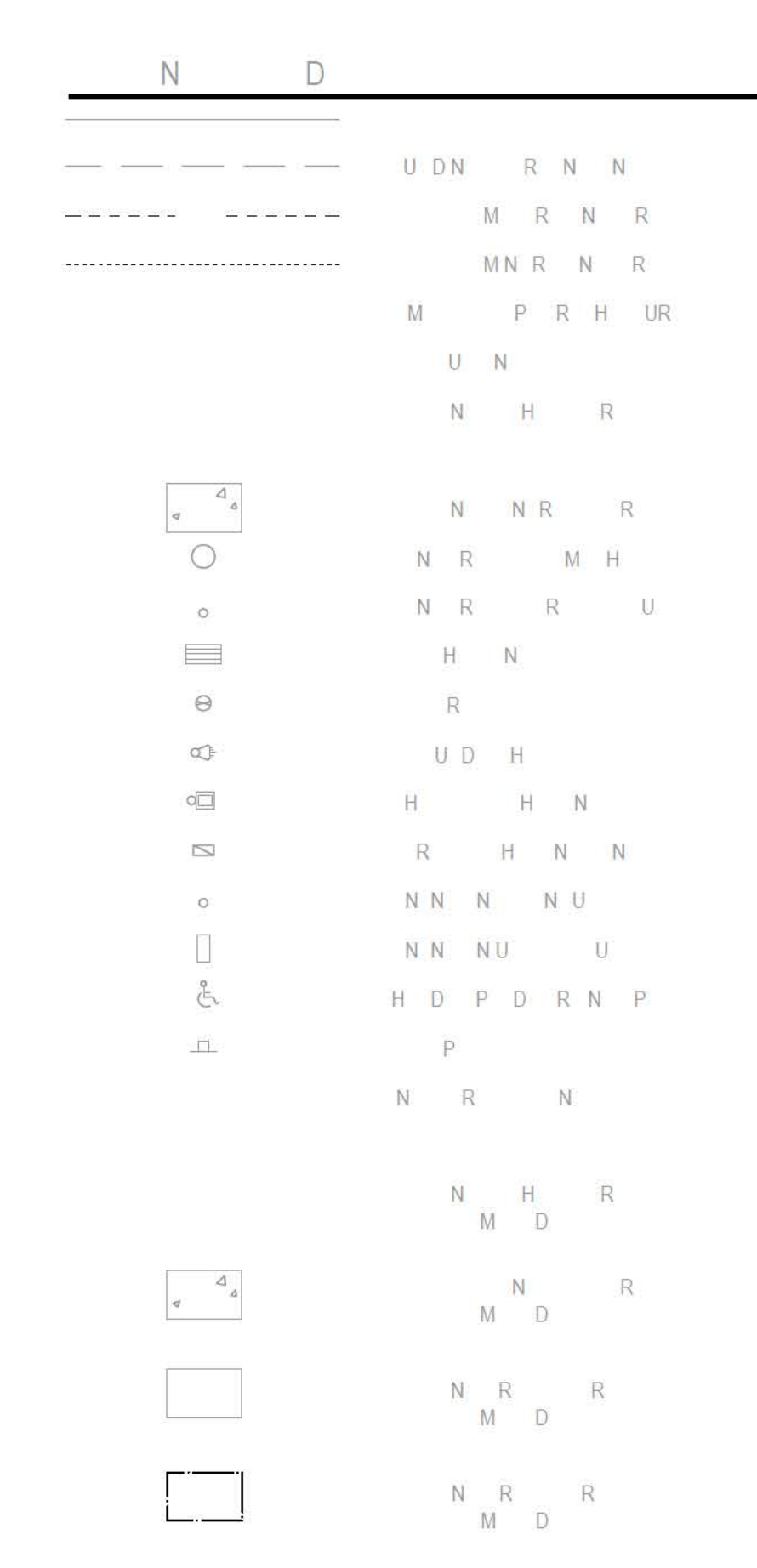
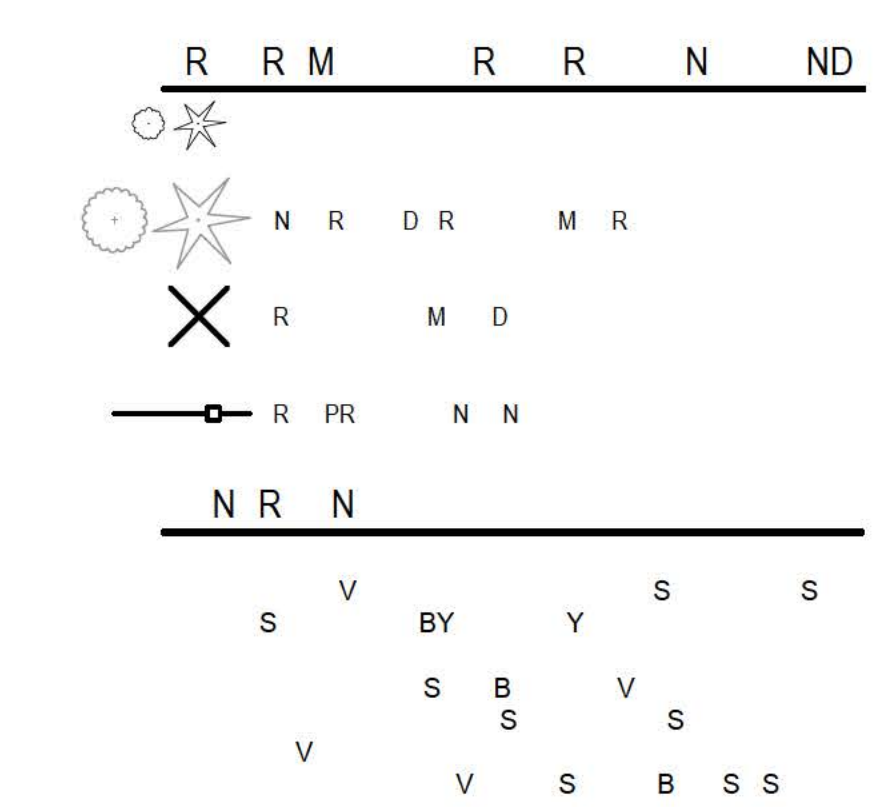
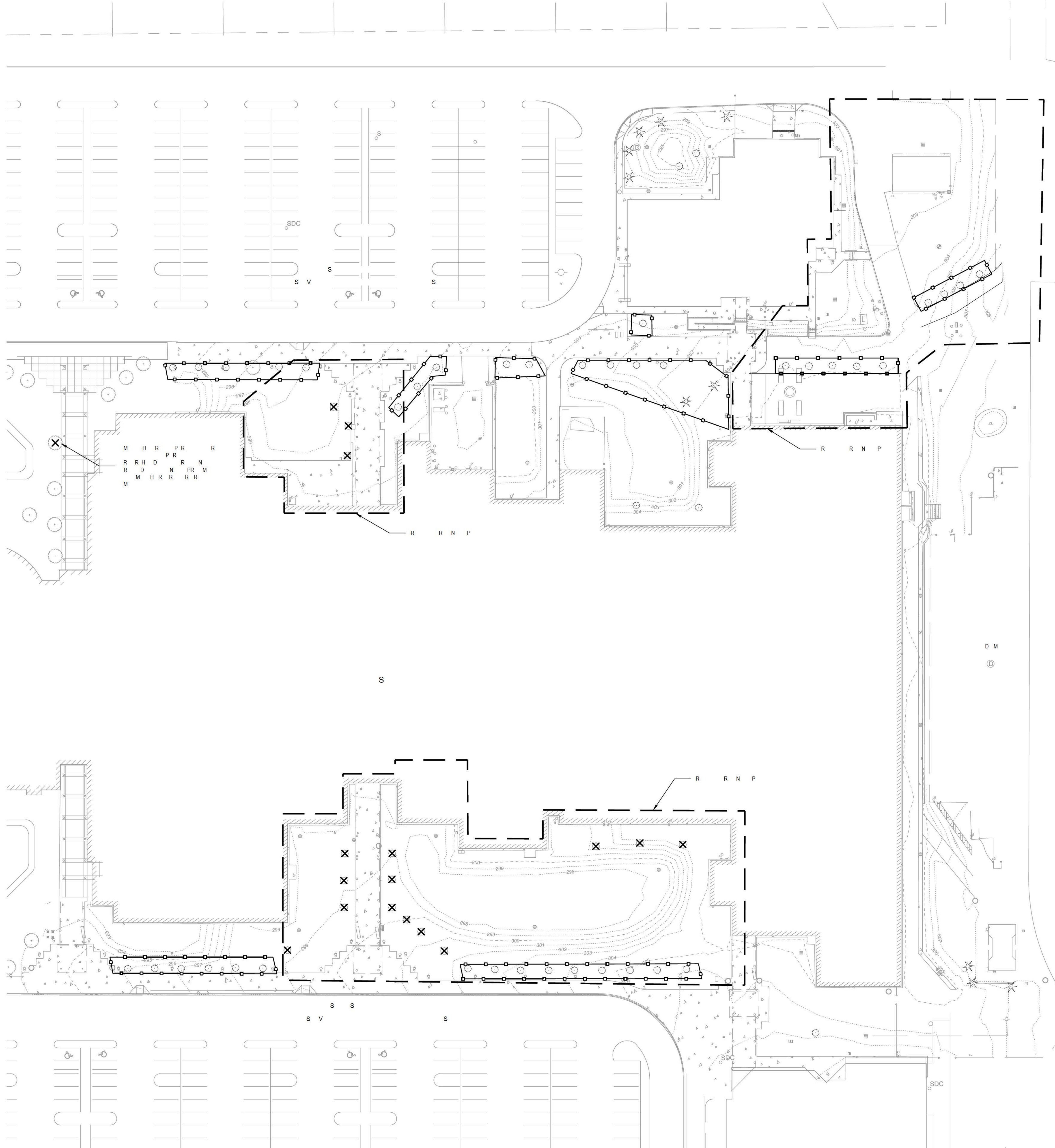

TUALATIN HIGH SCHOOL
RENOVATIONS AND ADDITIONS

#	DATE

TIGARD TUALATIN SD
TUALATIN
HIGH
SCHOOL

22300 SW BOONES FERRY RD.
TUALATIN, OR 97062

JOB NO: 21612290
ISSUE DATE: 12/13/17

TREE
PRESERVATION
& REMOVAL
PLAN - NORTH
L1.00

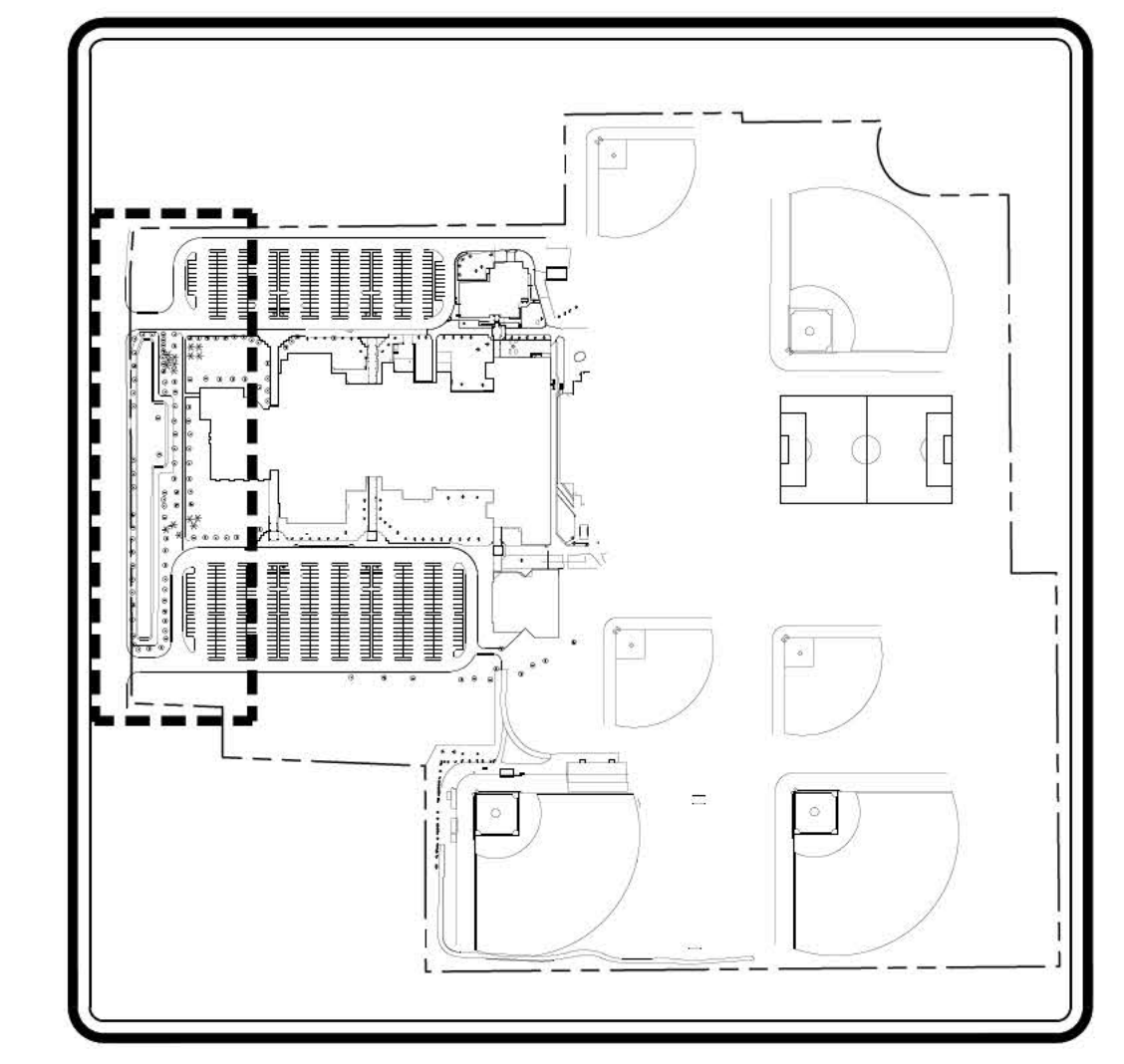
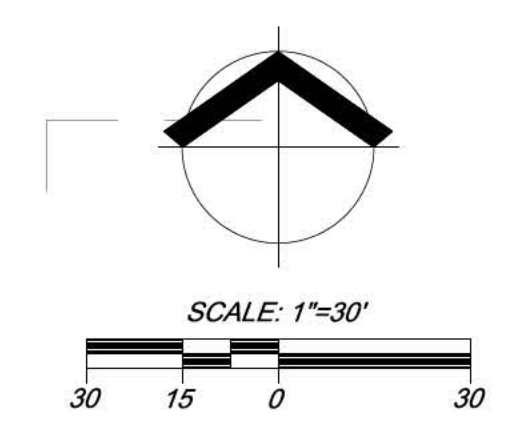
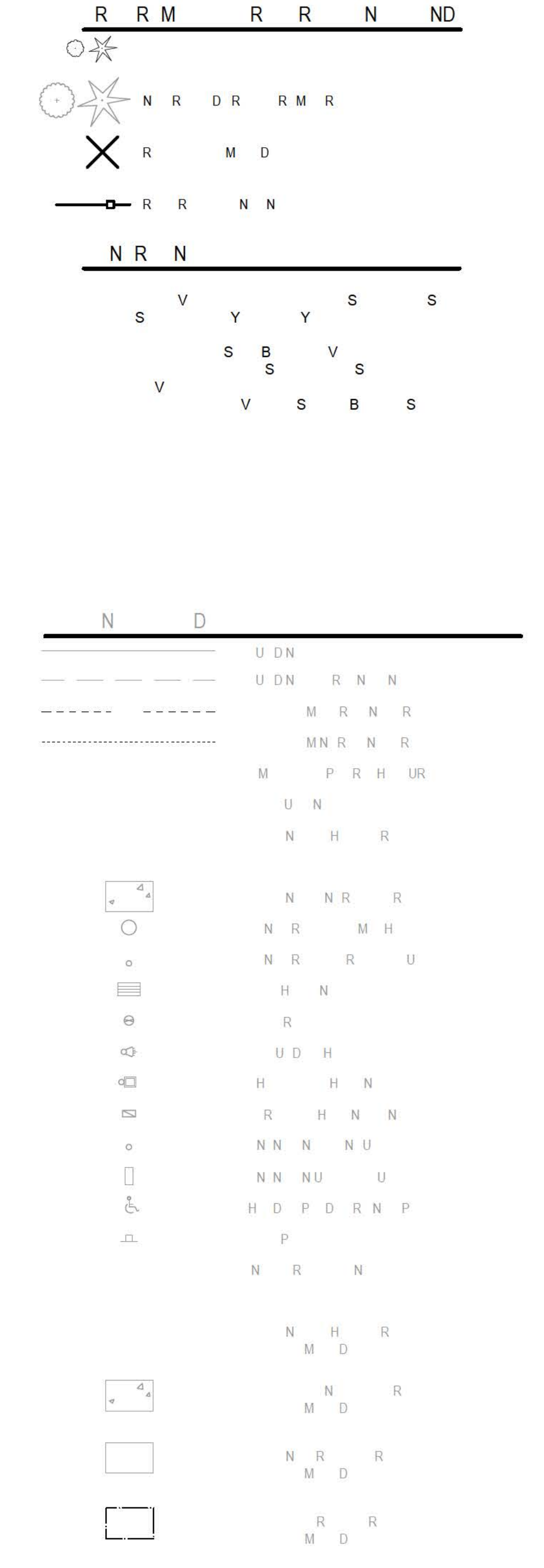
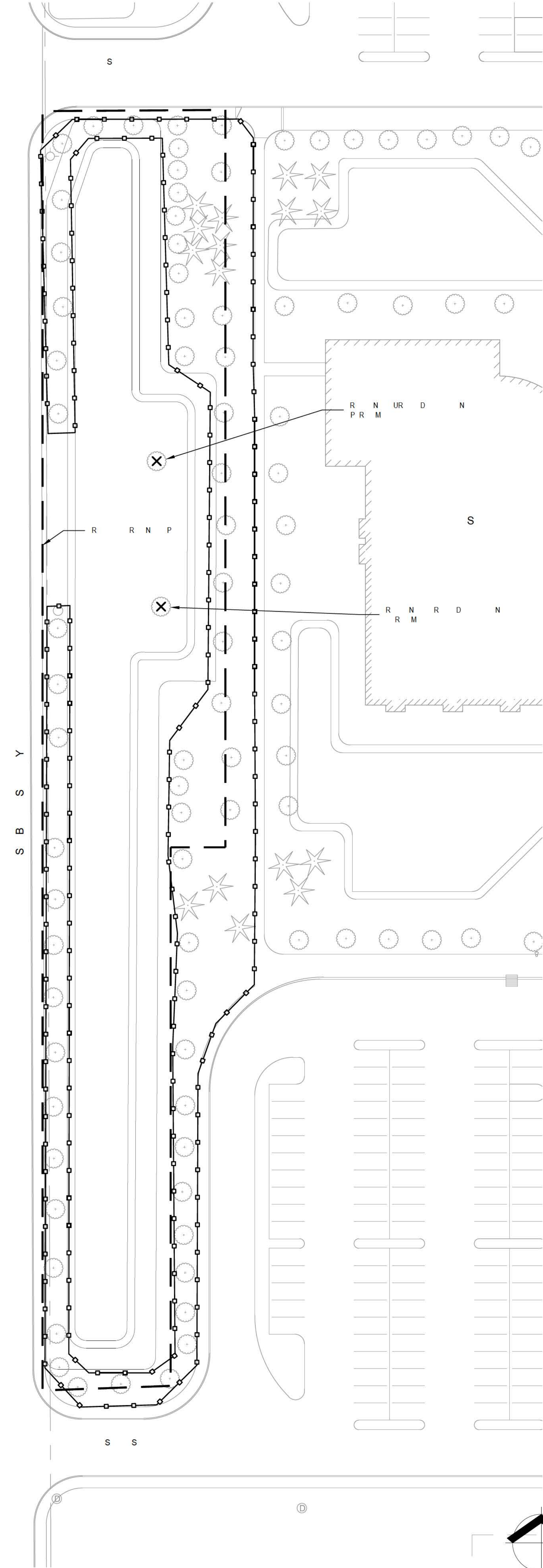
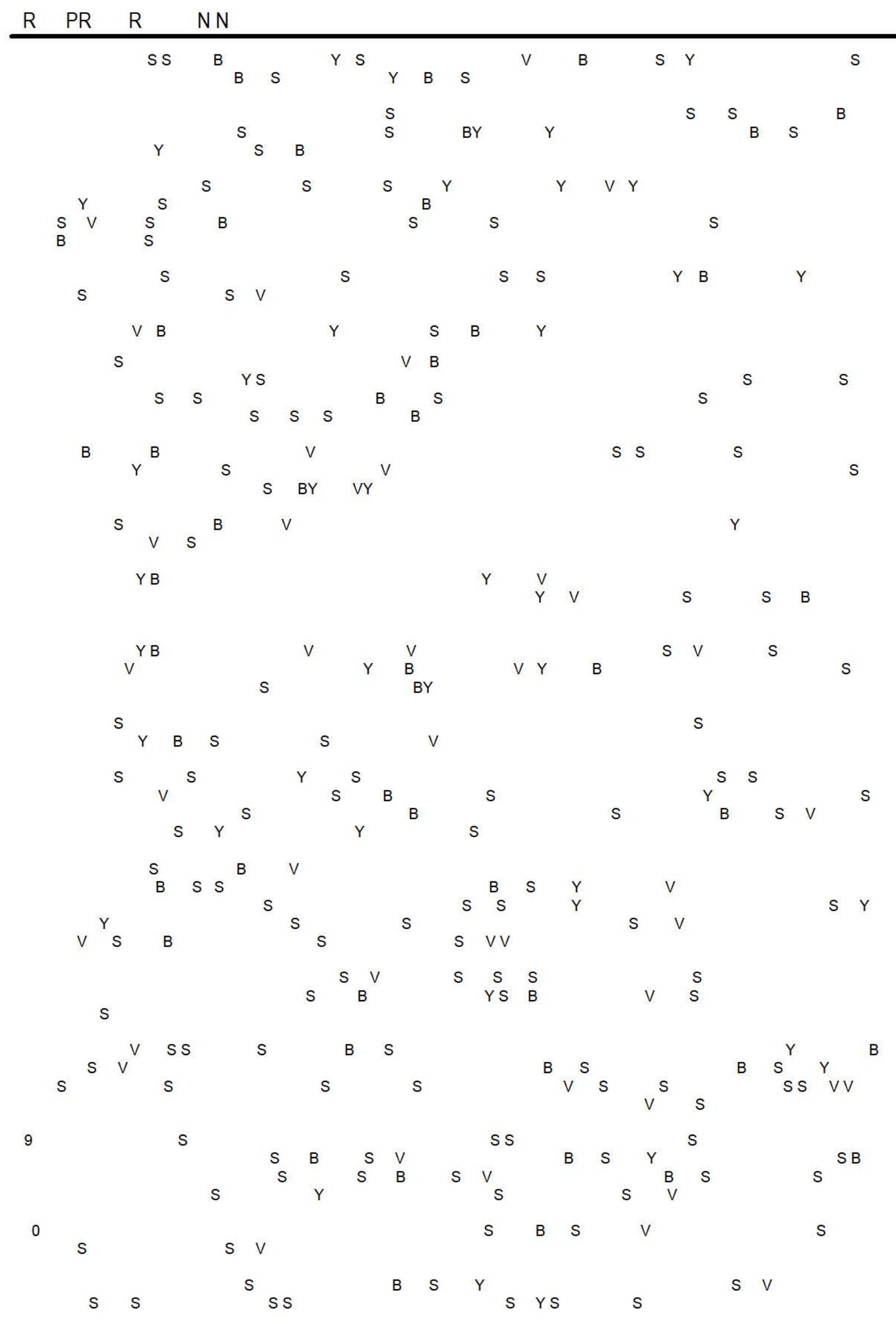

**TUALATIN HIGH SCHOOL
RENOVATIONS AND ADDITIONS**

DATE

TIGARD TUALATIN SD
**TUALATIN
HIGH
SCHOOL**

22300 SW BOONES FERRY RD.
TUALATIN, OR 97062

JOB NO: 21612290
ISSUE DATE: 12/13/17
S

**TREE
PRESERVATION
& REMOVAL
SW FACILITY
L1.01**

LAND USE

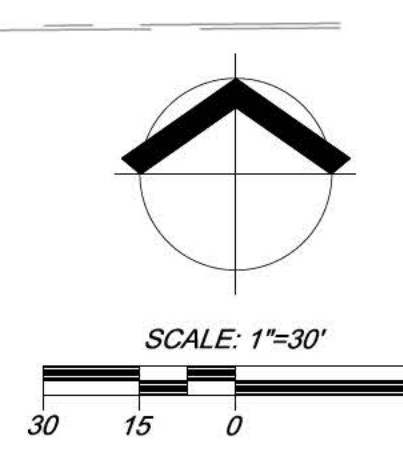
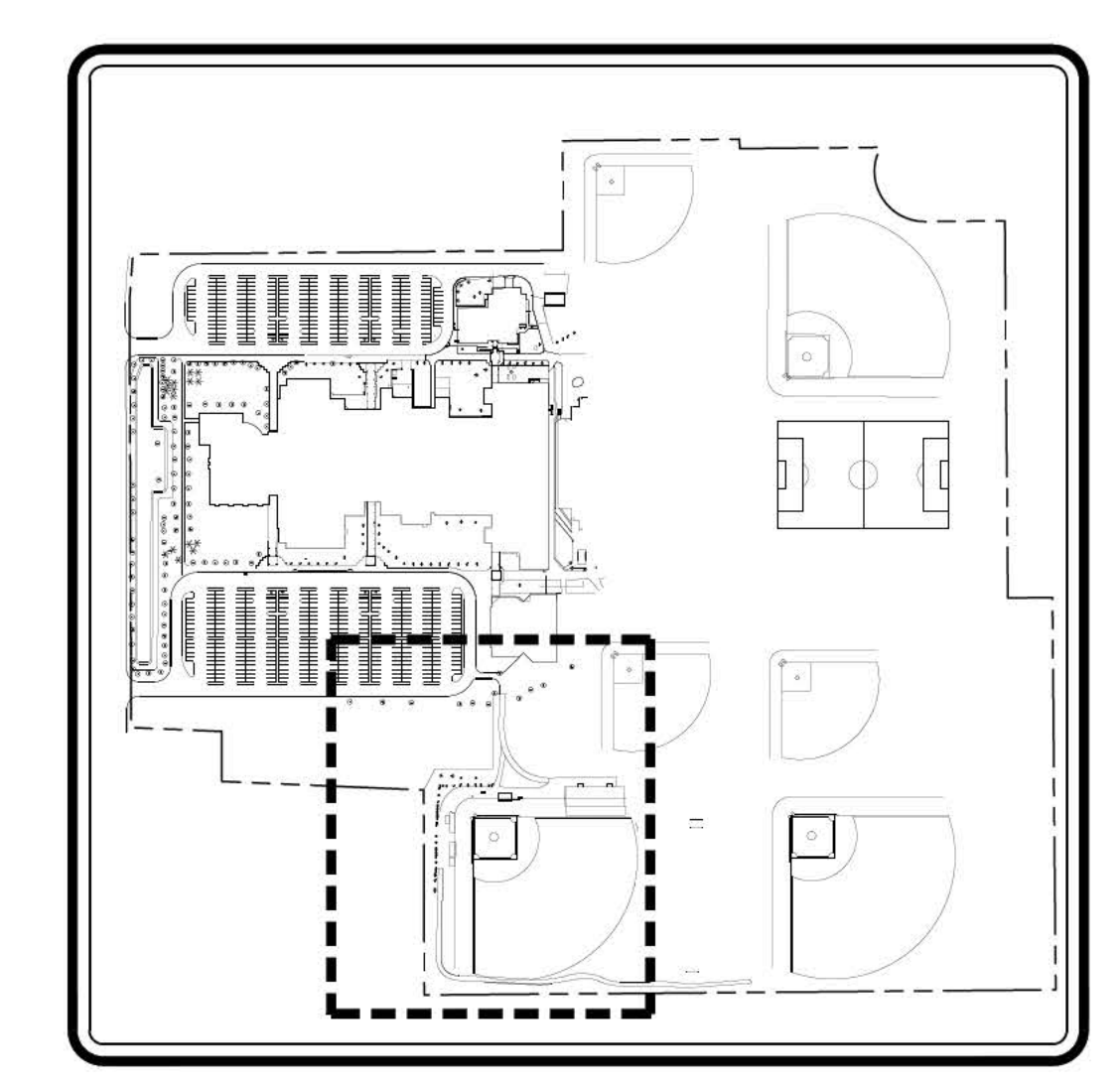
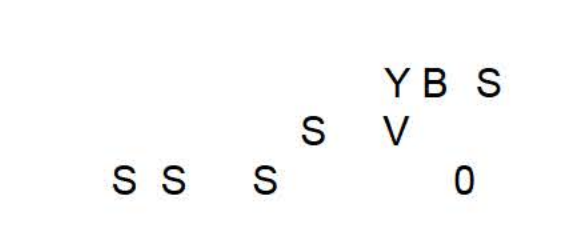
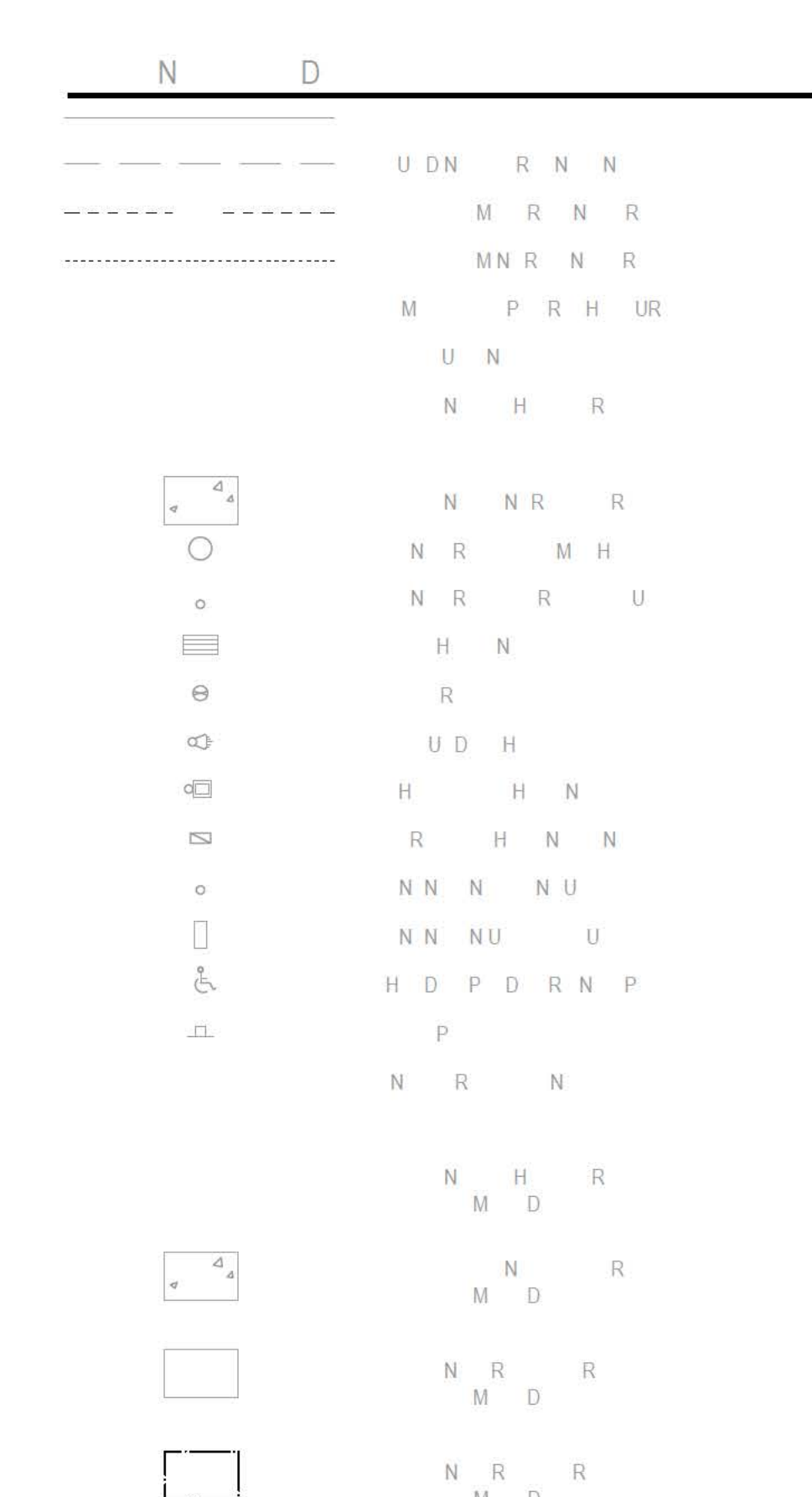
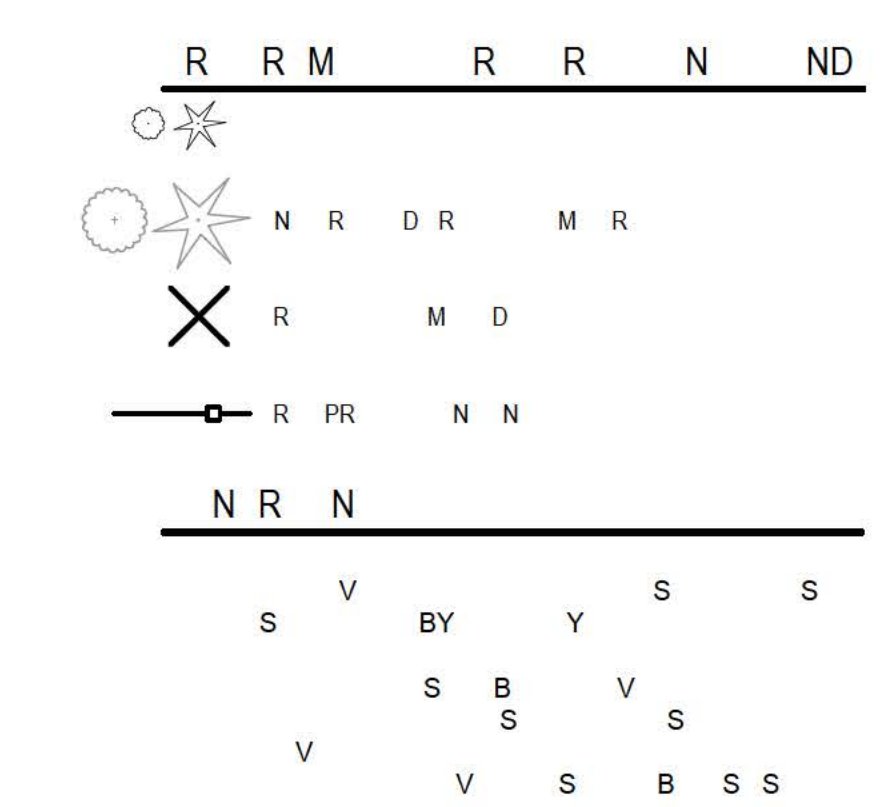
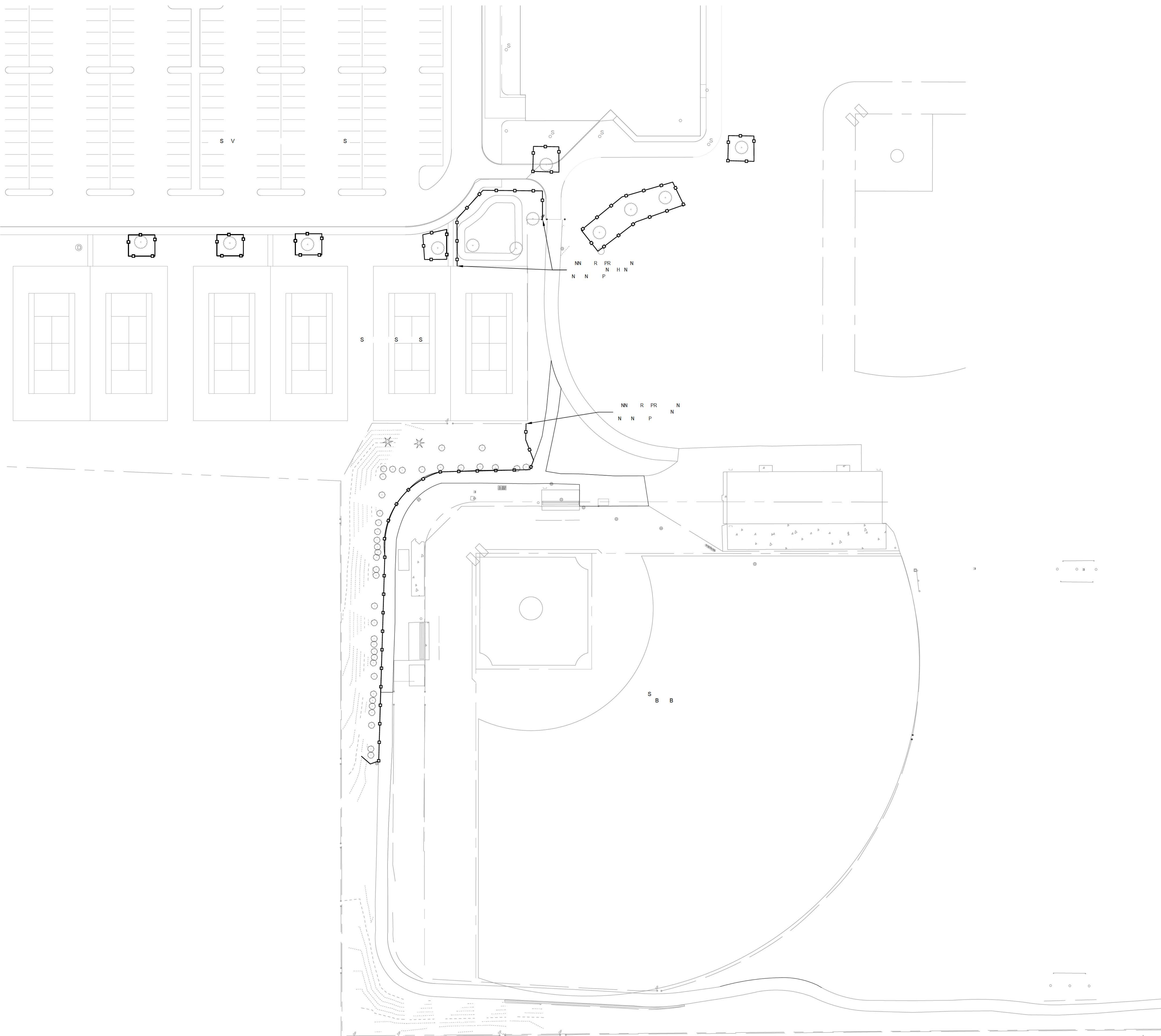

**TUALATIN HIGH SCHOOL
RENOVATIONS AND ADDITIONS**

DATE

**TIGARD TUALATIN SD
TUALATIN
HIGH
SCHOOL**

22300 SW BOONES FERRY RD.
TUALATIN, OR 97062

JOB NO: 21612290
ISSUE DATE: 12/13/17
S

**TREE
PRESERVATION
& REMOVAL
PLAN - SOUTH
L1.02**

LAND USE

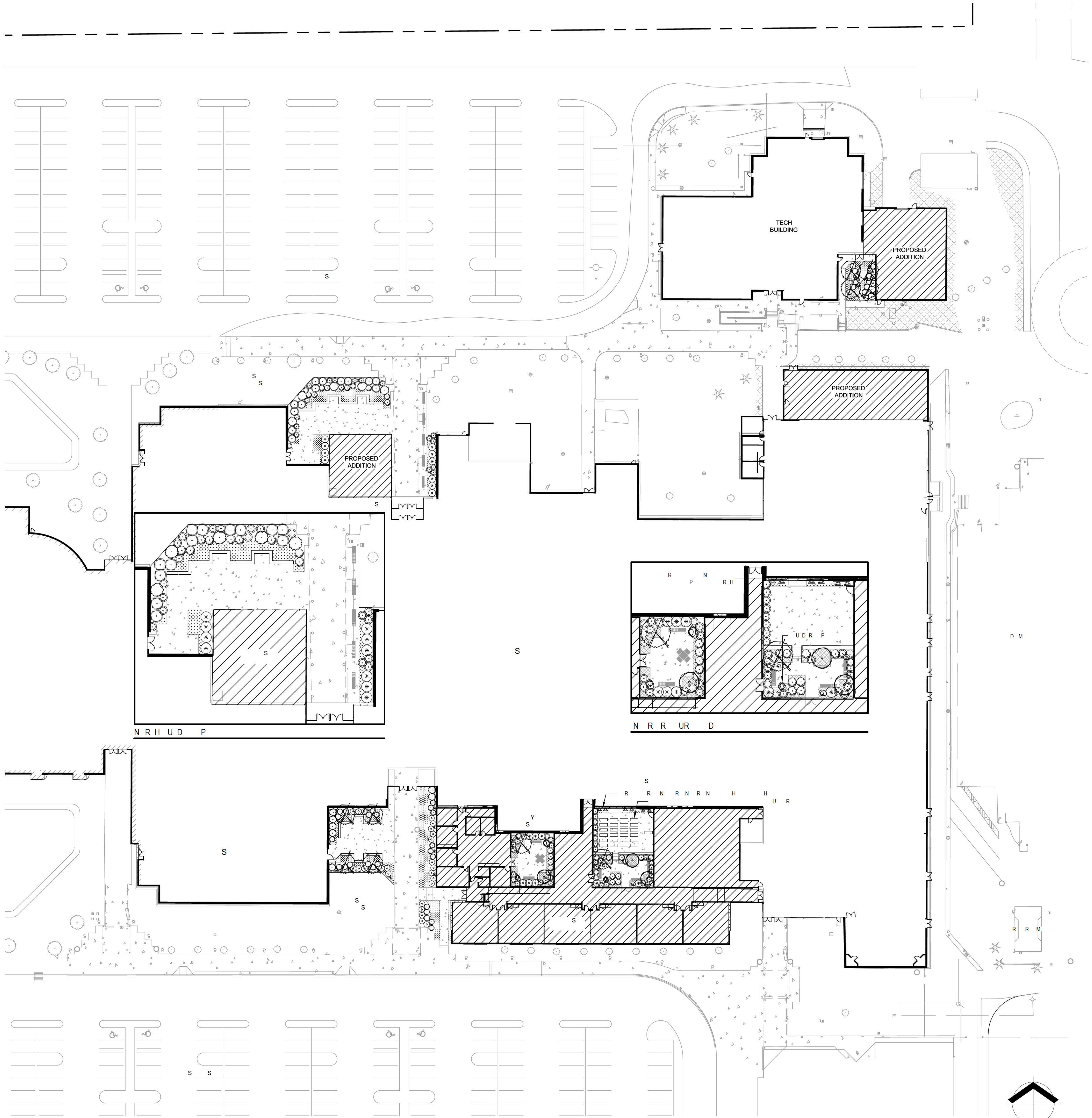

D C N M CH U

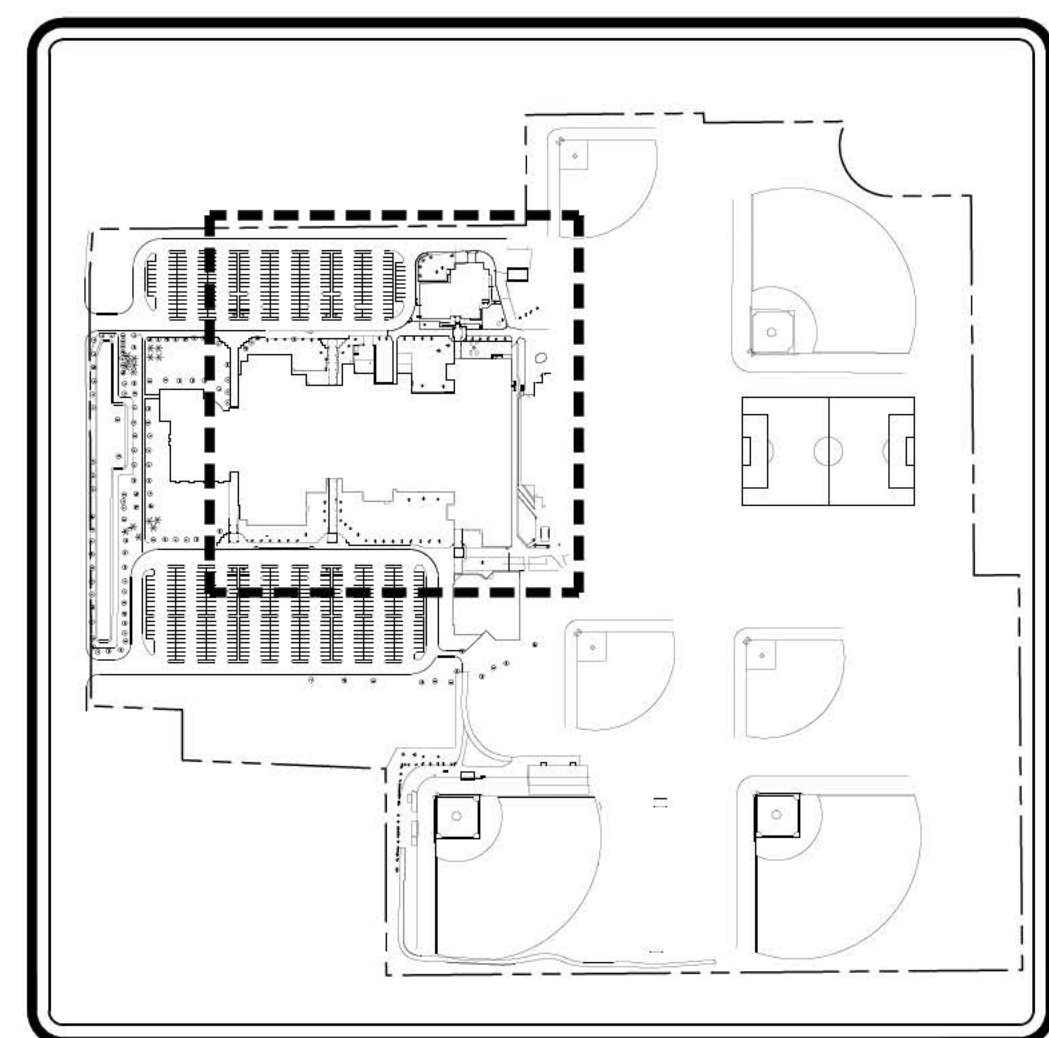
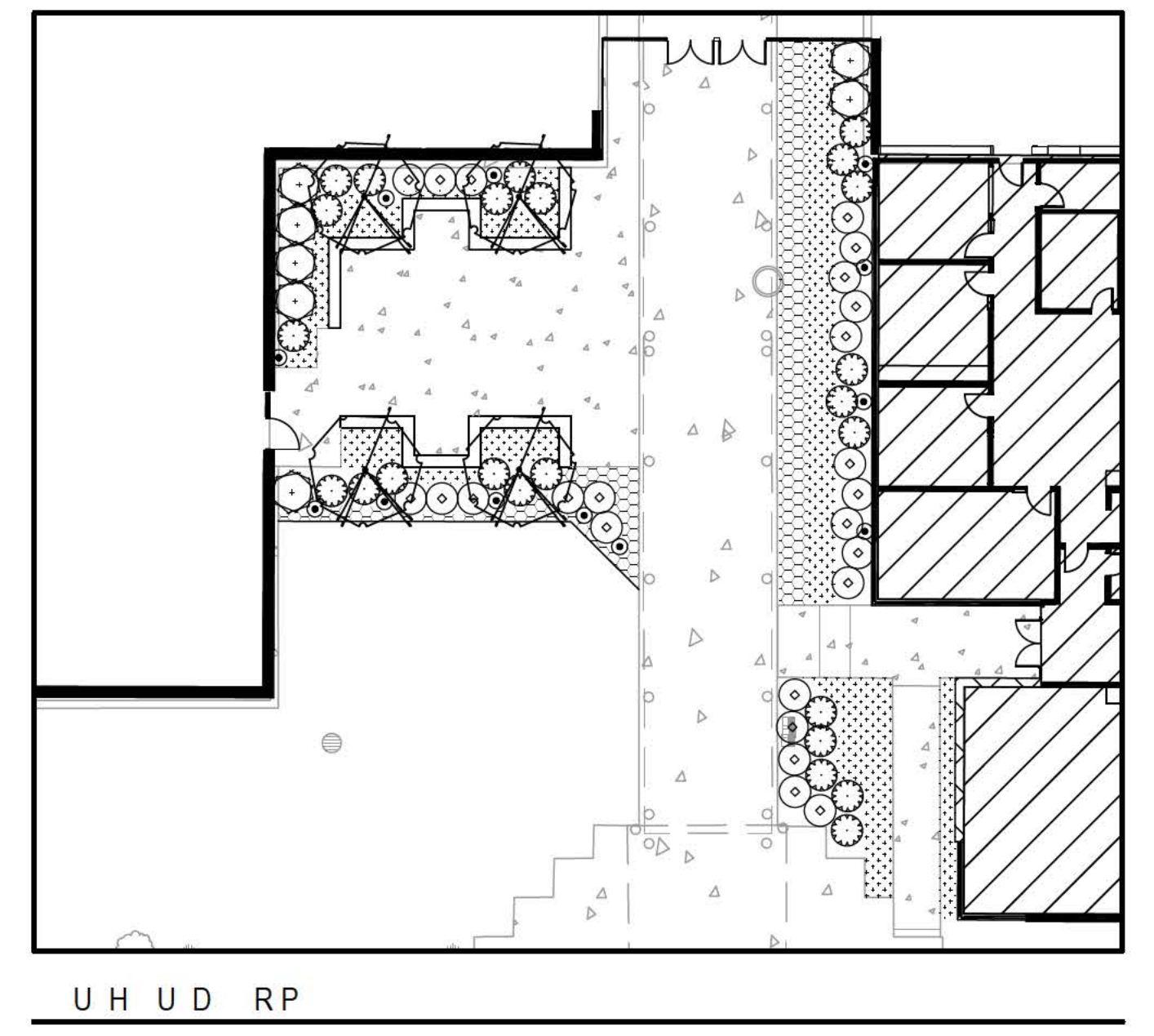
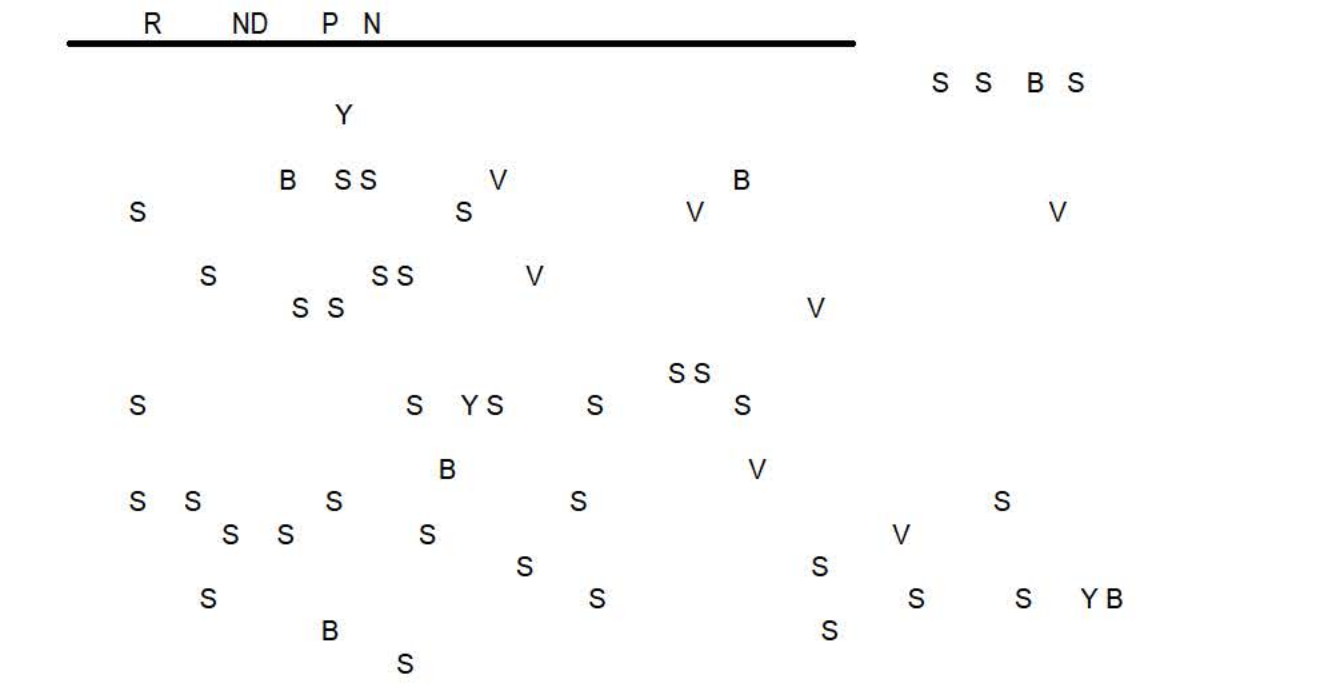
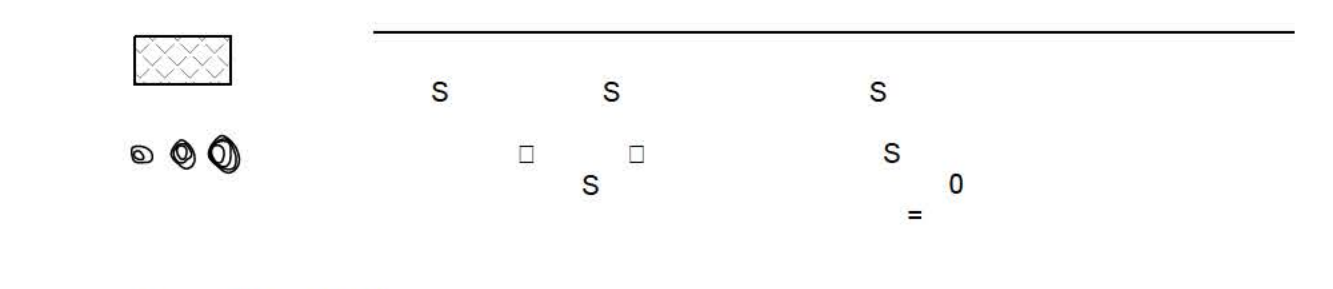
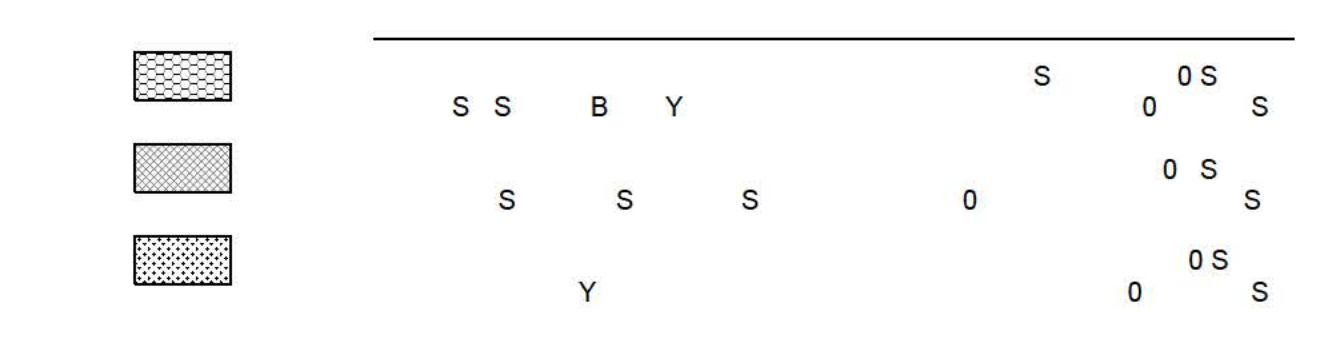
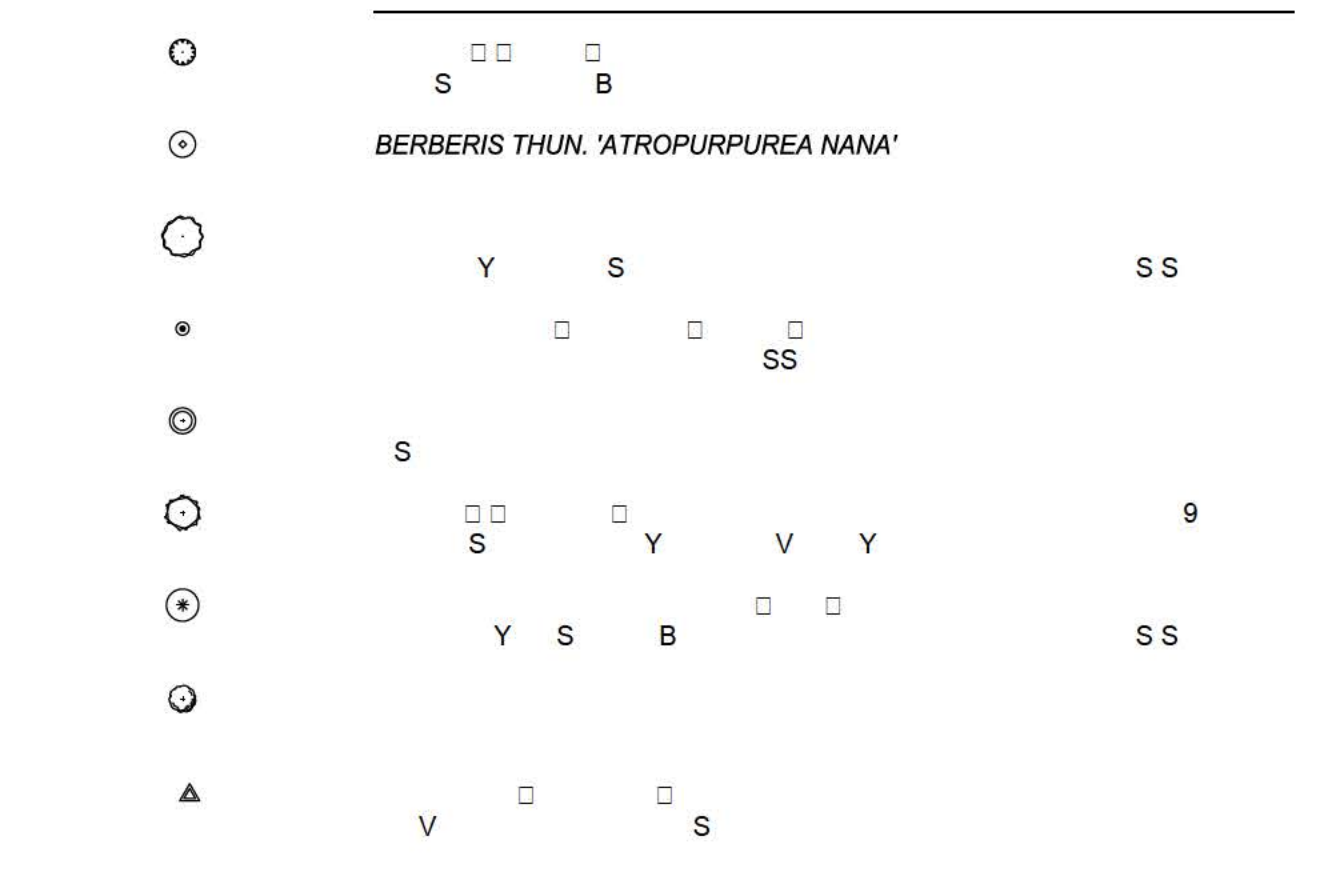
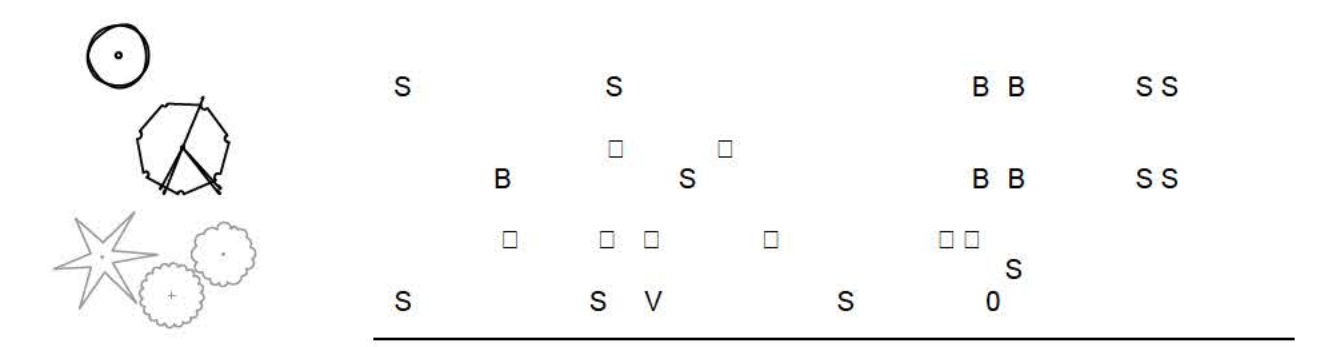

721 NW 9TH Ave, Suite 350
Portland, Oregon 97209
T (206) 340 9500 F (206) 340 9519

CIVIL ENGINEER & LANDSCAPE
Cardno
6720 SW Macadam Ave., Suite 200
Portland, OR 97219
T (503) 419-2500

STRUCTURAL ENGINEER
Catena Engineers
1111 NE Flanders St., Suite 206
Portland, OR 97232
T (503) 467-4980

MECHANICAL ELECTRICAL &
PLUMBING ENGINEER
Glumac
900 SW Fifth Ave., Suite 1600
Portland, OR 97204
T (503) 227-0280

FOOD SERVICE CONSULTANT
Webb Foodservice Design
3703 SE Lafayette Ct.
Portland, OR 97202
T (503) 236-8566

COST CONSULTANT
Construction Focus
740 Ahmadi St.
Eugene, OR 97402
T 541-686-2031



PORTLAND
6720 SW MACADAM AVE, STE 200, PORTLAND, OR 97219
TEL: (503) 419-2500 FAX: (503) 419-2500
www.cardno.com

TUALATIN HIGH SCHOOL
RENOVATIONS AND ADDITIONS

#	DATE

TIGARD TUALATIN SD
TUALATIN
HIGH
SCHOOL

22300 SW BOONES FERRY RD.
TUALATIN, OR 97062

JOB NO: 21612290
ISSUE DATE: 12/13/17

LANDSCAPE
PLANTING PLAN

L2.00

LAND USE

TUALATIN HIGH SCHOOL
RENOVATIONS AND ADDITIONS

DATE

TIGARD TUALATIN SD
TUALATIN
HIGH
SCHOOL

22300 SW BOONES FERRY RD.
TUALATIN, OR 97062

JOB NO: 21612290
ISSUE DATE: 12/13/17

S

PLANTING PLAN
STORMWATER
FACILITY

L2.01

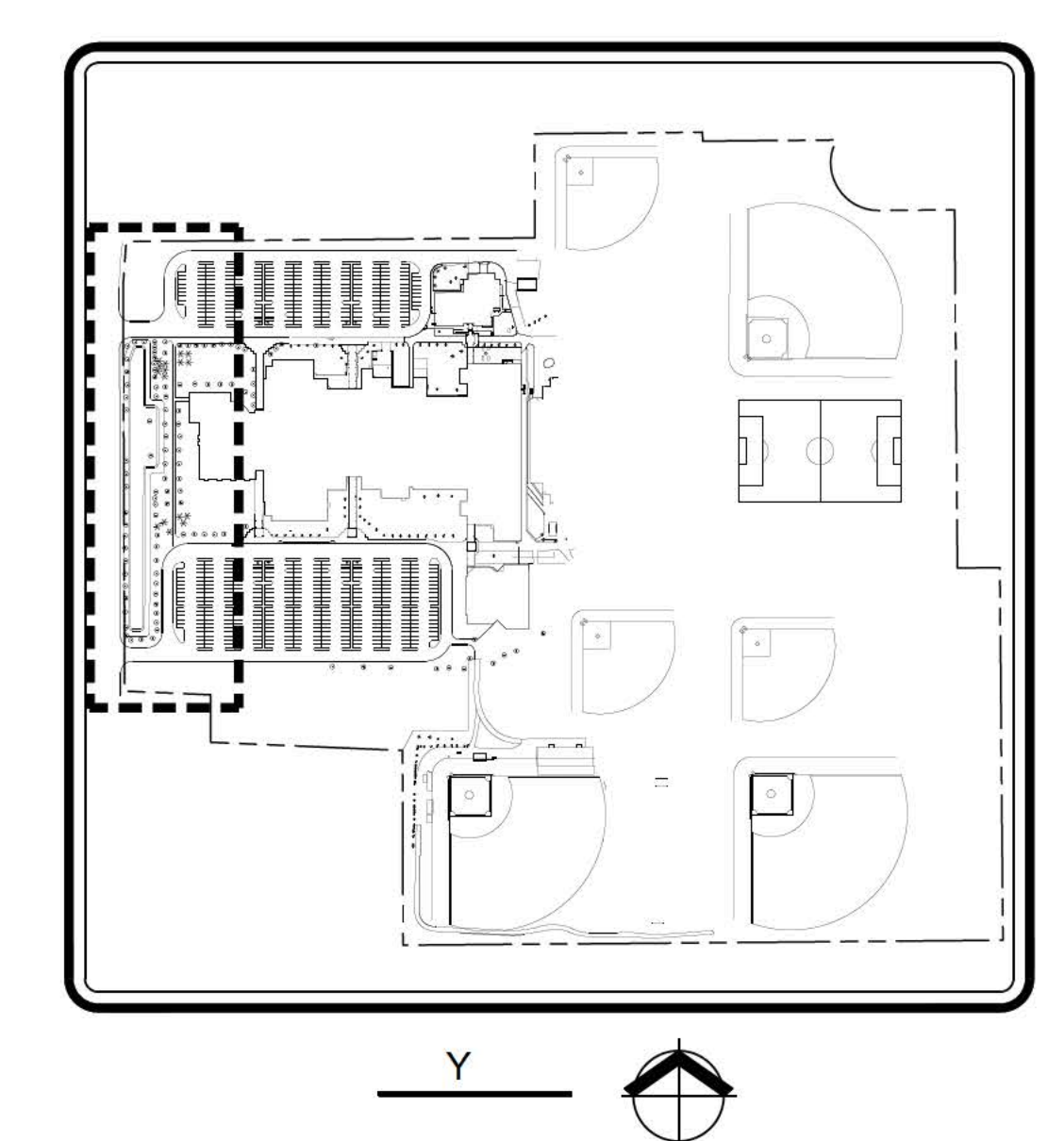
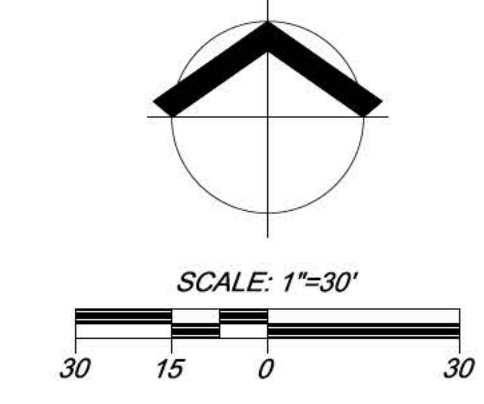
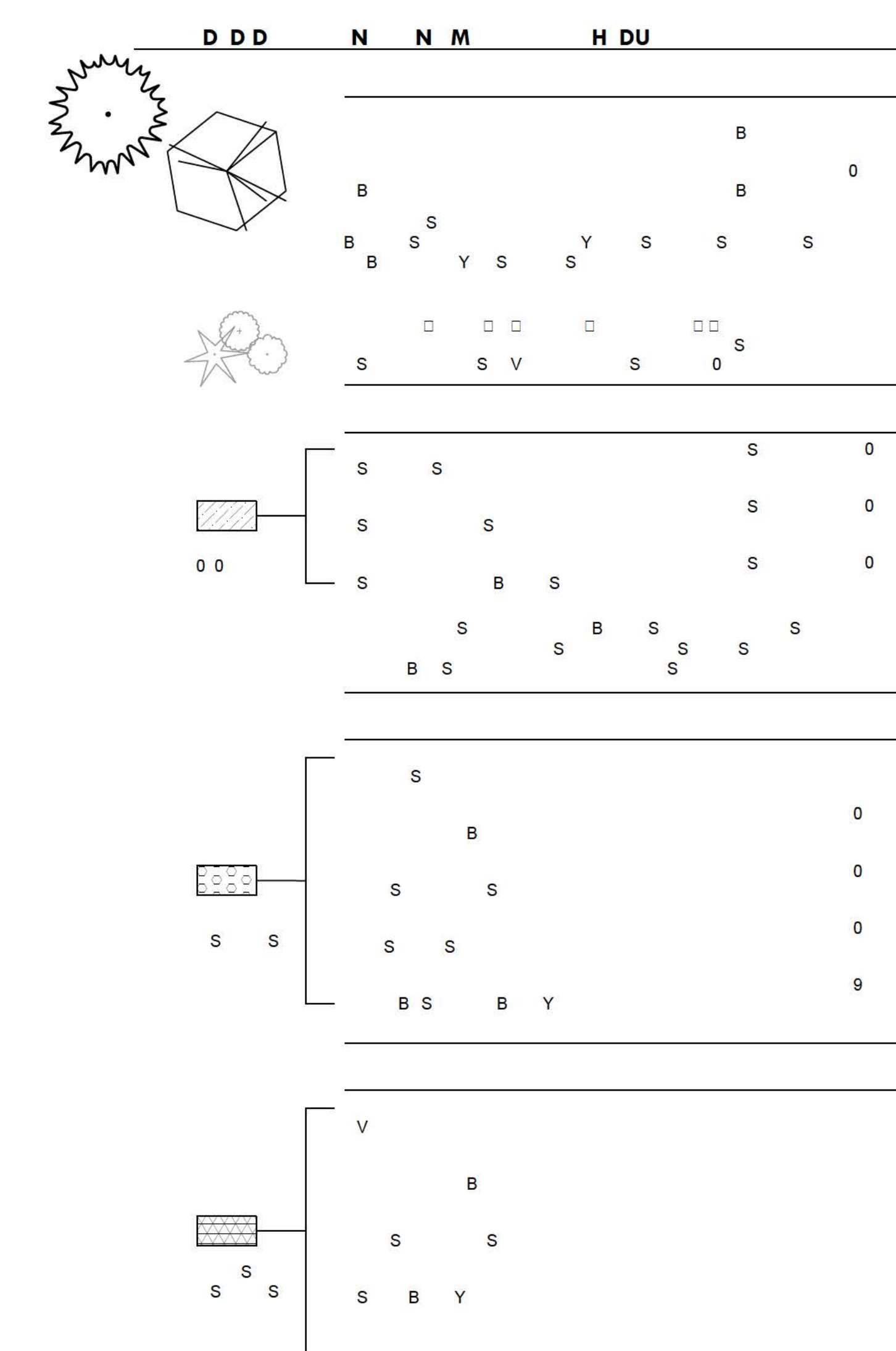
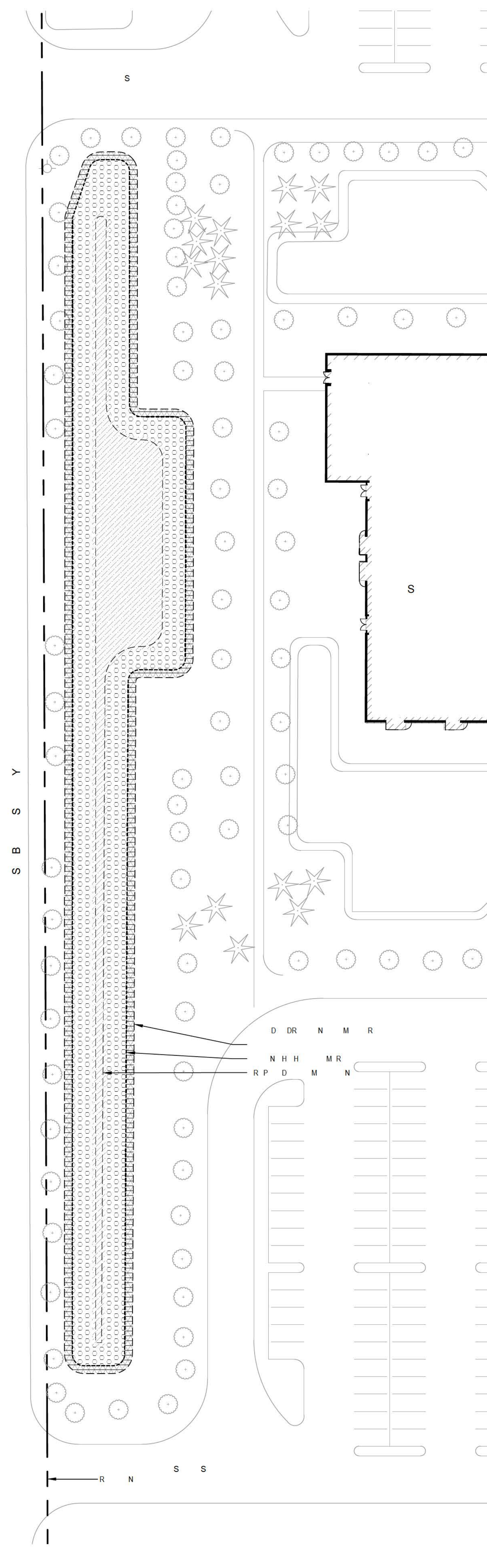
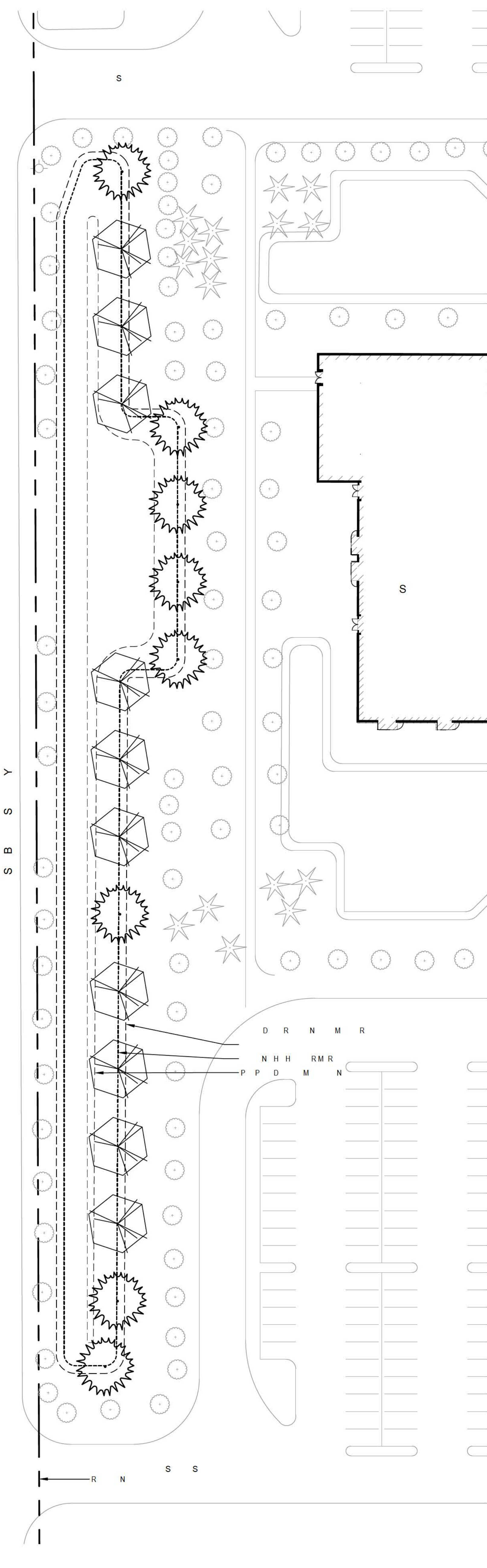

LAND USE

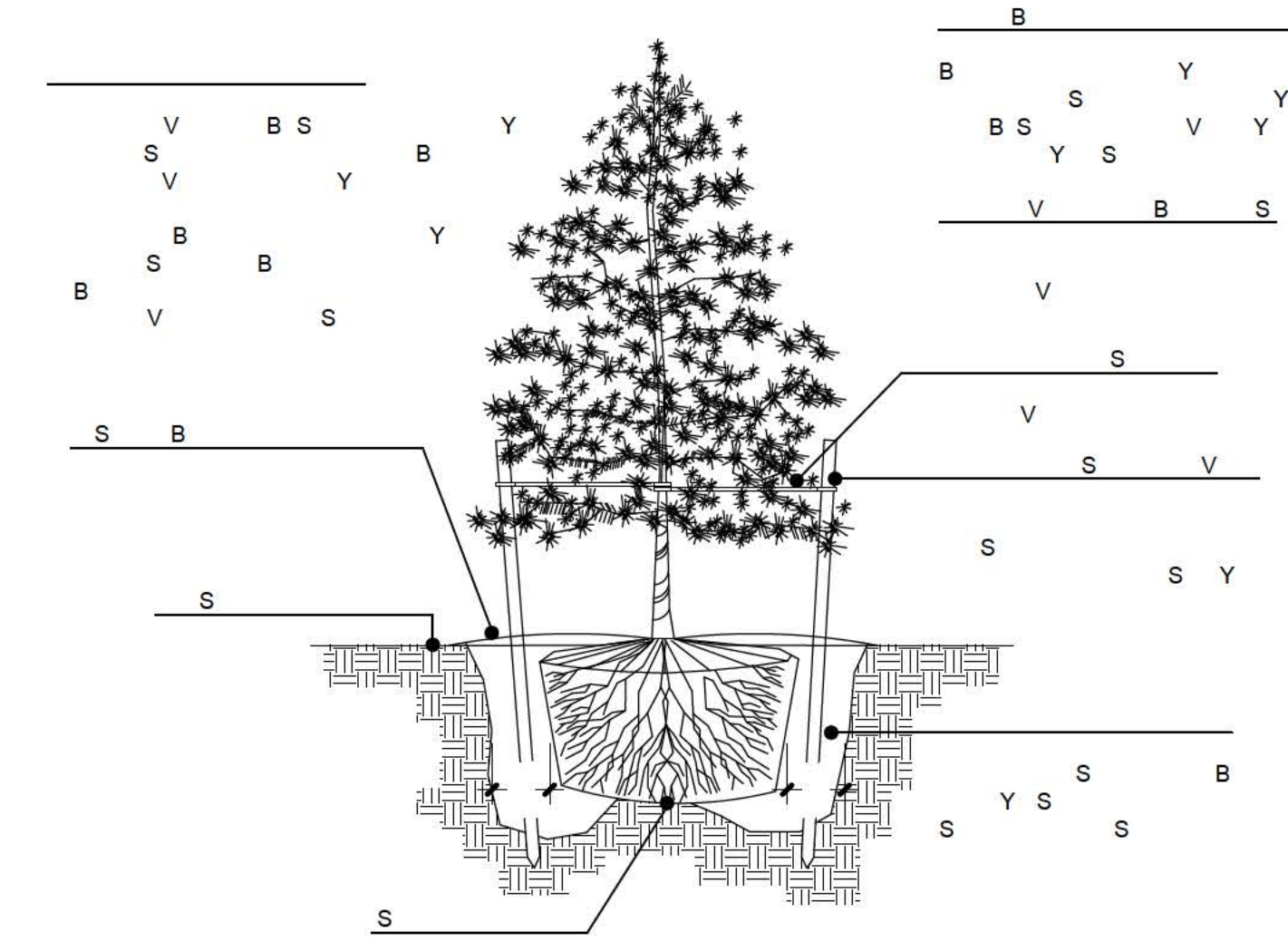
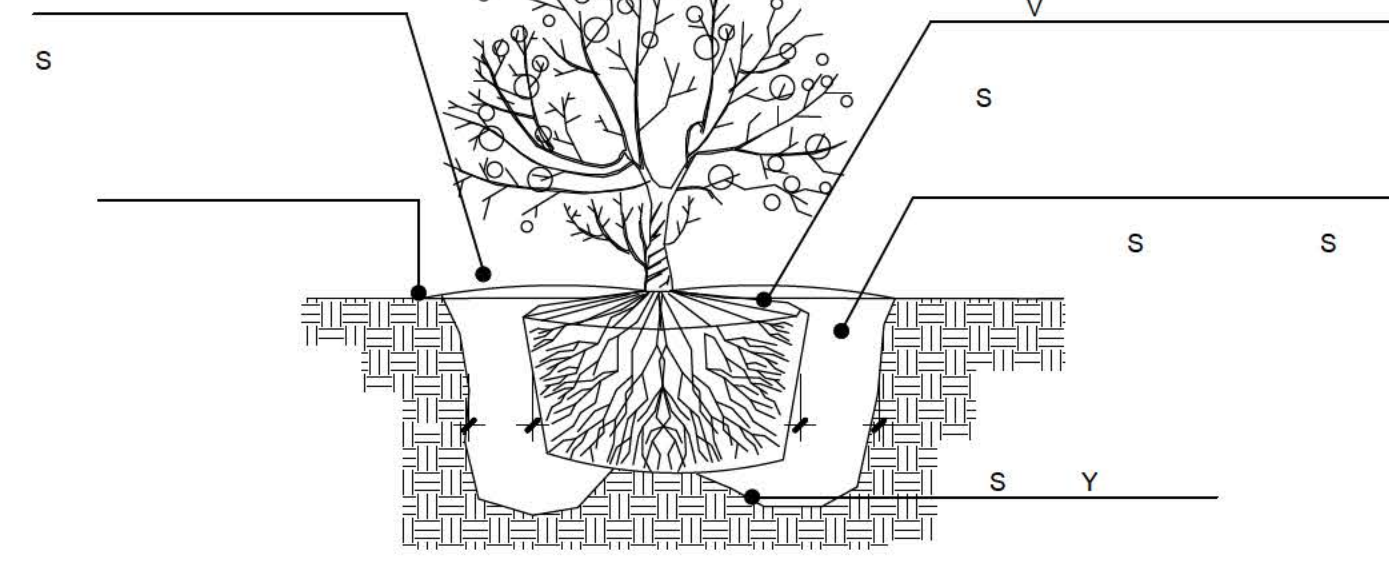
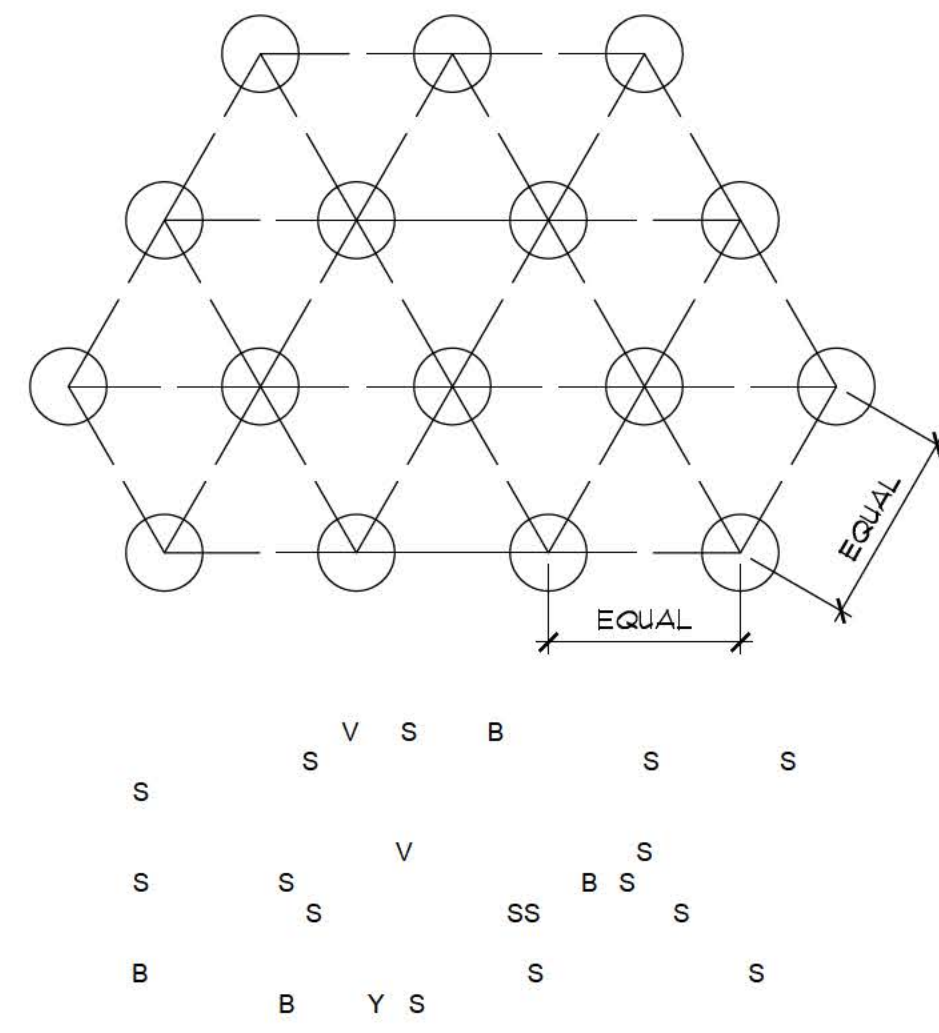

R U D R P N D R M

H U P N N

R R N R P N N

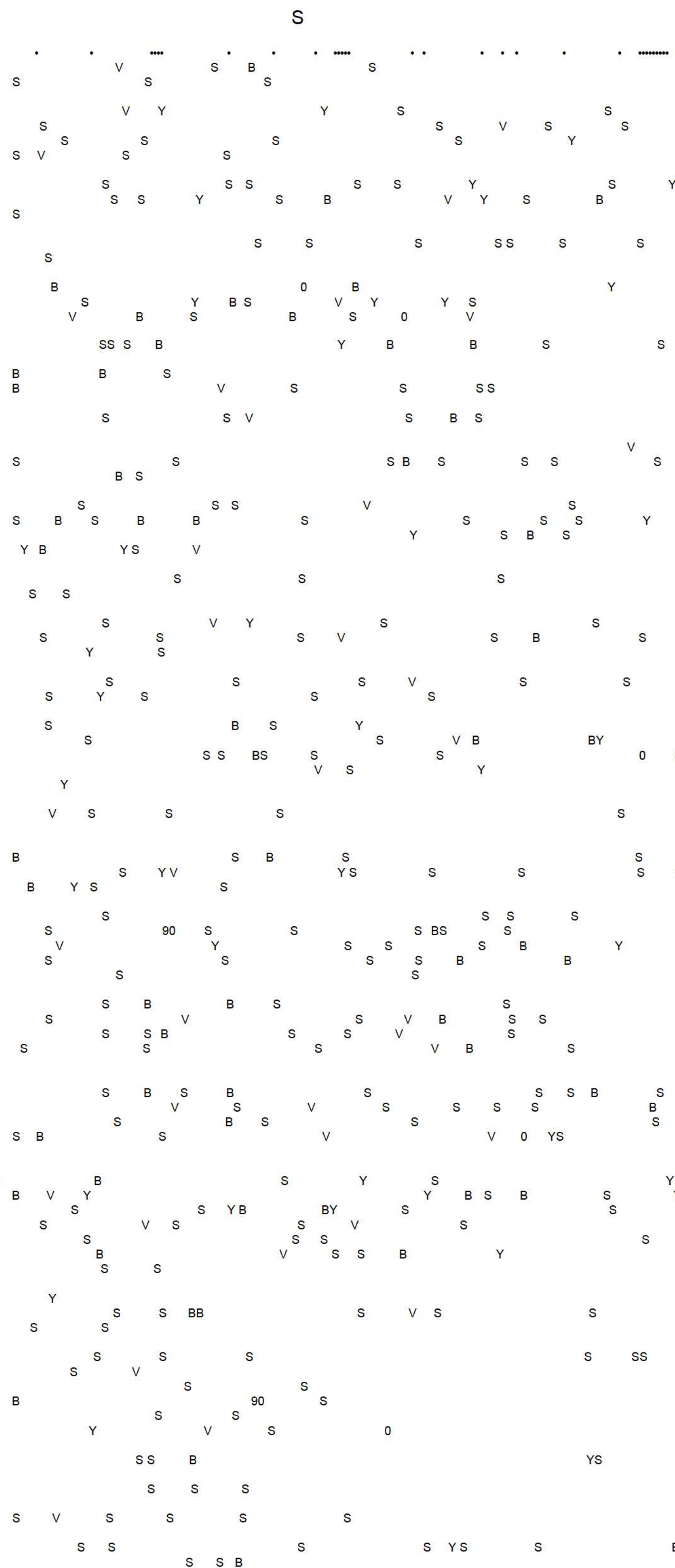
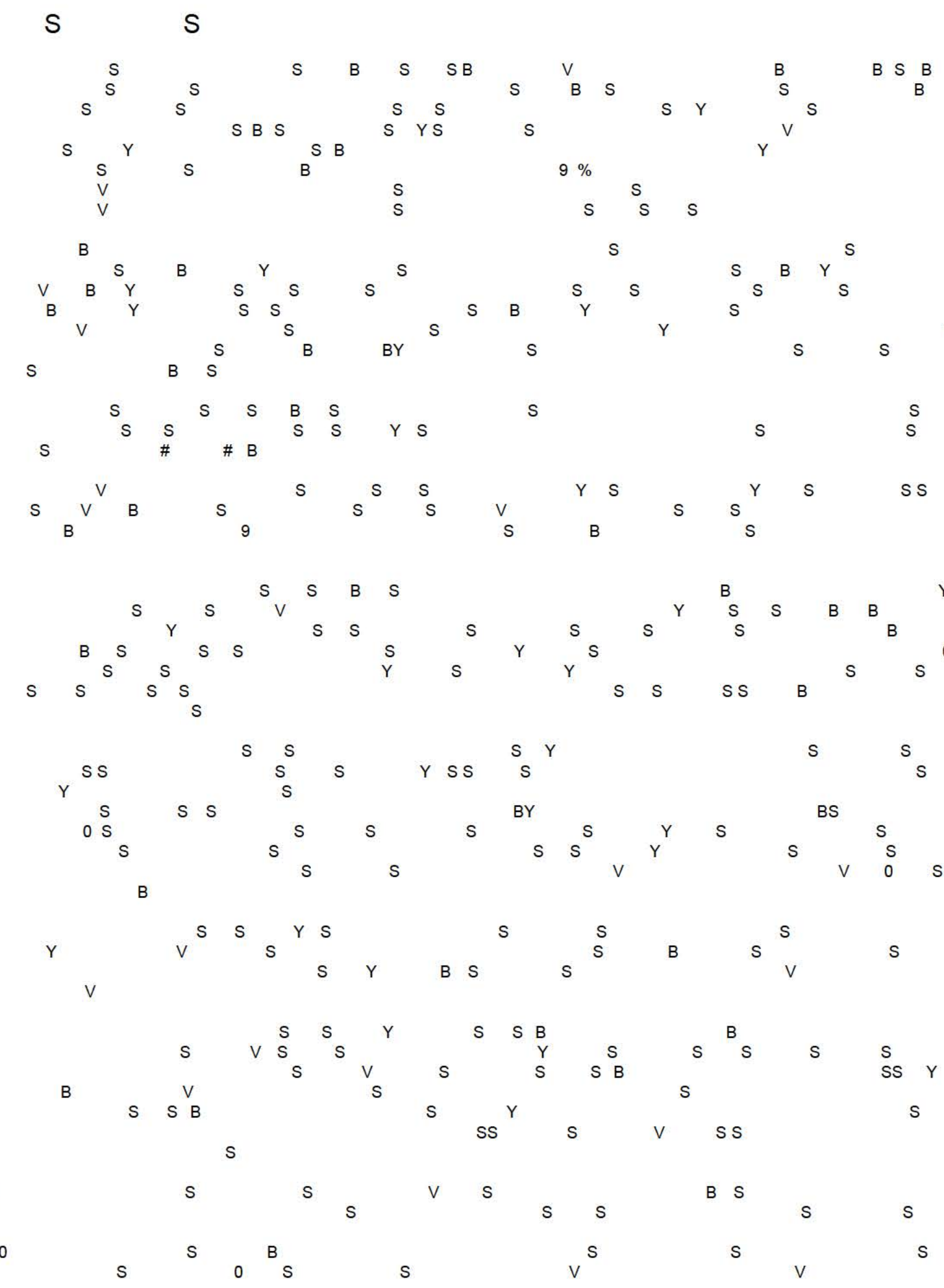
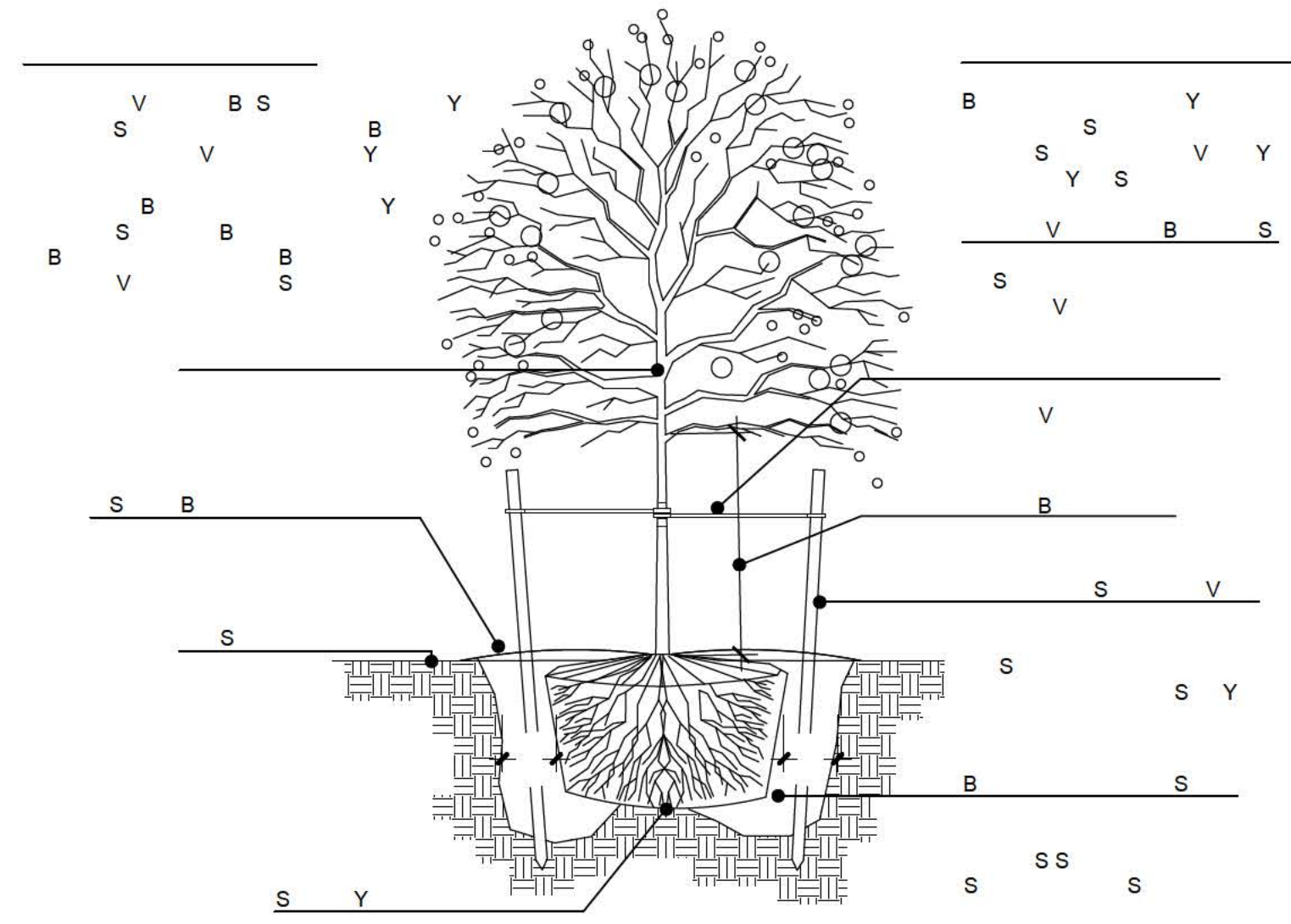

D D U U R P N N

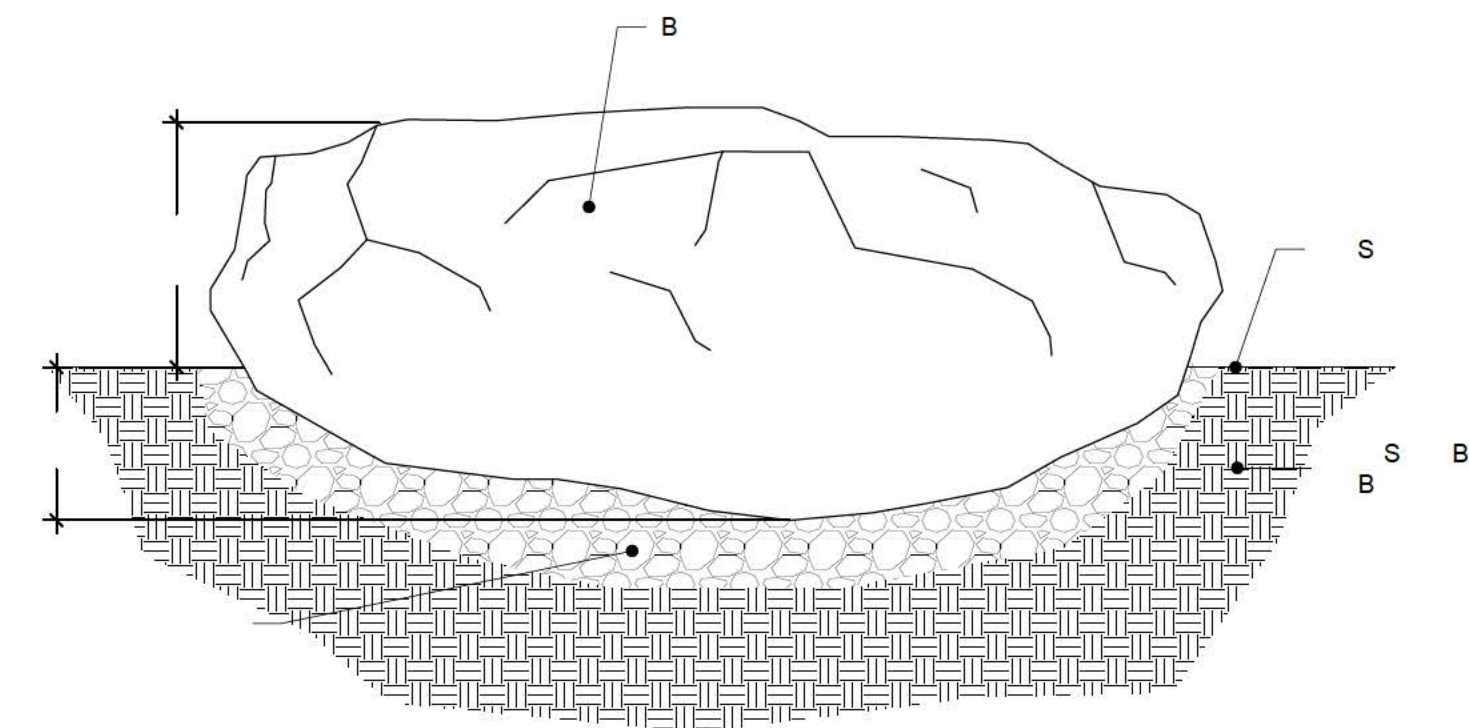

U D P M N

P N

P N N R N N



First American

First American Title Company of Oregon

121 SW Morrison Street, Suite 300

Portland, OR 97204

Phn - (503)222-3651 (800)929-3651

Fax - (877)242-3513

MULTNOMAH COUNTY TITLE UNIT

FAX (877)242-3513

Title Officer: **Dona Cramer**

(503)222-3651

dcramer@firstam.com

LOT BOOK SERVICE

Tigard-Tualatin School District 23J
6960 SW Sandburg Street
Tigard, OR 97223

Order No.: 7019-2944125

October 04, 2017

Attn: Sarah Mehrabzadeh
Phone No.: (503)431-4093 - Fax No.: (503)431-4037
Email: smehrabzadeh@ttsd.k12.or.us

Re:

Fee: \$300.00

We have searched our Tract Indices as to the following described property:

The land referred to in this report is described in Exhibit A attached hereto.

and as of September 18, 2017 at 8:00 a.m.

We find that the last deed of record runs to

Tigard School District

We find the following apparent encumbrances prior to the effective date hereof:

1. Taxes for the fiscal year 2017-2018 a lien due, but not yet payable.
2. Statutory powers and assessments of Clean Water Services.
3. The rights of the public in and to that portion of the premises herein described lying within the limits of streets, roads and highways.

4. Easement, including terms and provisions contained therein:
Recording Information: February 20, 1992 as Fee No. 92010426
In Favor of: City of Tualatin
For: Sanitary sewer
Affects: Parcel II
5. Easement, including terms and provisions contained therein:
Recording Information: March 18, 1992 as Fee No. 92017072
In Favor of: Portland General Electric Company
For: Electric power line
Affects: Westerly portion
6. Easement, including terms and provisions contained therein:
Recording Information: May 06, 1994 as Fee No. 94044693
In Favor of: City of Tualatin
For: Storm drainage
Affects: Westerly portion
7. Easement, including terms and provisions contained therein:
Recording Information: May 6, 1994 as Fee No. 94044694
In Favor of: City of Tualatin
For: Sanitary sewer
Affects: Westerly portion
8. Easement, including terms and provisions contained therein:
Recording Information: March 27, 2001 as Fee No. 2001025327
In Favor of: City of Tualatin
For: Storm drain
Affects: 15 foot wide strip
9. A lease dated August 20, 2010, executed by Tigard-Tualatin School District No. 23J as lessor and Tigard-Tualatin Aquatic District as lessee, recorded August 23, 2010 as Fee No. 2010 064702 of Official Records.
10. Any claim that the Title is subject to a trust or lien created under The Perishable Agricultural Commodities Act, 1930 (7 U.S.C. §§499a, et seq.) or the Packers and Stockyards Act (7 U.S.C. §§181 et seq.) or under similar state laws.

We have also searched our General Index for Judgments and State and Federal Liens against the Grantee(s) named above and find:

NONE

We find the following unpaid taxes and city liens:

1. City liens, if any, of the City of Tualatin.

2. Subject property is under public ownership and is tax exempt. Any change in ownership before delivery of assessment roll may result in tax liability. Account No. R559470.

THIS IS NOT a title report since no examination has been made of the title to the above described property. Our search for apparent encumbrances was limited to our Tract Indices, and therefore above listings do not include additional matters which might have been disclosed by an examination of the record title. We assume no liability in connection with this Lot Book Service and will not be responsible for errors or omissions therein. The charge for this service will not include supplemental reports, rechecks or other services.

Exhibit "A"

Real property in the County of Washington, State of Oregon, described as follows:

PARCEL I:

BEGINNING AT AN IRON PIPE ON THE SECTION LINE NORTH 89° 30' EAST 957.0 FEET FROM THE ONE-QUARTER CORNER OF THE NORTH LINE OF SECTION 35, TOWNSHIP 2 SOUTH, RANGE 1 WEST, WILLAMETTE MERIDIAN, IN THE CITY OF TUALATIN, WASHINGTON COUNTY, OREGON, SAID BEGINNING POINT BEING THE NORTHEAST CORNER OF THE TRACT OF LAND CONVEYED TO FRED HEIDER BY DEED DESCRIBED ON PAGE 575, BOOK 171 OF DEED RECORDS OF WASHINGTON COUNTY, OREGON; RUNNING THENCE SOUTH 0°05 1/2' EAST 231.0 FEET TO AN IRON PIPE SET FOR THE SOUTHEAST CORNER OF THE SAID HEIDER TRACT; THENCE SOUTH 89°30' WEST ON THE SOUTH LINE OF THE SAID HEIDER TRACT 957.0 FEET TO THE SOUTHWEST CORNER THEREOF; THENCE SOUTH 0°05 1/2' EAST 500.7 FEET TO A POINT FROM WHICH AN IRON PIPE BEARS NORTH 89°30' EAST 30.0 FEET; THENCE NORTH 89°30' EAST 957.0 FEET TO AN IRON PIPE, THENCE SOUTH 29°35' EAST 274.9 FEET TO AN IRON PIPE; THENCE NORTH 89°30' EAST 794.5 FEET TO AN IRON PIPE; THENCE NORTH 0°05 1/2' WEST 972.0 FEET TO AN IRON PIPE ON THE NORTH LINE OF SAID SECTION 35; THENCE SOUTH 89°30' WEST ALONG SAID SECTION LINE, A DISTANCE OF 930.0 FEET TO THE TRUE PLACE OF BEGINNING.

EXCEPTING THEREFROM:

A PARCEL OF LAND SITUATED IN THE NORTHEAST ONE-QUARTER OF SECTION 35, TOWNSHIP 2 SOUTH, RANGE 1 WEST OF THE WILLAMETTE MERIDIAN, IN THE CITY OF TUALATIN, COUNTY OF WASHINGTON AND STATE OF OREGON, BEING MORE PARTICULARLY DESCRIBED AS FOLLOWS:

BEGINNING AT THE SOUTHWEST CORNER OF LOT 125, DAKOTA HILLS NO. 1, A PLAT OF RECORD IN THE COUNTY OF WASHINGTON AND STATE OF OREGON; THENCE ALONG THE SOUTH LINE OF LOT 125, DAKOTA HILLS NO. 1, NORTH 89 DEGREES 27'50" EAST, 71.00 FEET TO THE SOUTHEAST CORNER OF SAID LOT 125; THENCE SOUTH 00 DEGREES 08'59" EAST, 20.00 FEET TO A 5/8 INCH X 30 INCH IRON ROD WITH YELLOW PLASTIC CAP STAMPED "COMPASS CORP."; THENCE ALONG A LINE PARALLEL TO AND 20 FEET SOUTH OF THE SOUTH LINE OF LOT 125, DAKOTA HILLS NO. 1, SOUTH 89 DEGREES 27'50" WEST, 71.00 FEET TO A 5/8 INCH X 30 INCH IRON ROD WITH YELLOW PLASTIC CAP STAMPED "COMPASS CORP."; THENCE NORTH 00 DEGREES 08'59" WEST, 20.00 FEET TO THE POINT OF BEGINNING.

ALSO EXCEPTING THEREFROM:

A PARCEL OF LAND SITUATED IN THE NORTHEAST ONE-QUARTER OF SECTION 35, TOWNSHIP 2 SOUTH, RANGE 1 WEST OF THE WILLAMETTE MERIDIAN, IN THE CITY OF TUALATIN, COUNTY OF WASHINGTON AND STATE OF OREGON, BEING MORE PARTICULARLY DESCRIBED AS FOLLOWS:

BEGINNING AT THE SOUTHWEST CORNER OF LOT 124, DAKOTA HILLS NO. 1, A PLAT OF RECORD IN THE COUNTY OF WASHINGTON AND STATE OF OREGON; THENCE ALONG THE SOUTH LINE OF LOT 124, DAKOTA HILLS NO. 1, NORTH 89 DEGREES 27'50" EAST, 70.00 FEET TO THE SOUTHEAST CORNER OF SAID LOT 124; THENCE SOUTH 00 DEGREES 08'59" EAST, 20.00 FEET TO A 5/8 INCH X 30 INCH IRON ROD WITH YELLOW PLASTIC CAP STAMPED "COMPASS CORP."; THENCE ALONG A LINE PARALLEL TO AND 20 FEET SOUTH OF THE SOUTH LINE OF LOT 124, DAKOTA HILLS NO. 1, SOUTH 89 DEGREES 27'50" WEST, 70.00 FEET TO A 5/8 INCH X 30 INCH IRON ROD WITH YELLOW PLASTIC CAP STAMPED "COMPASS CORP."; THENCE NORTH 00 DEGREES 08'59" WEST, 20.00 FEET TO THE POINT OF BEGINNING.

FURTHER EXCEPTING THEREFROM:

A PARCEL OF LAND SITUATED IN THE NORTHEAST ONE-QUARTER OF SECTION 35, TOWNSHIP 2 SOUTH, RANGE 1 WEST OF THE WILLAMETTE MERIDIAN, IN THE CITY OF TUALATIN, COUNTY OF WASHINGTON AND STATE OF OREGON, BEING MORE PARTICULARLY DESCRIBED AS FOLLOWS:

BEGINNING AT THE SOUTHWEST CORNER OF LOT 123, DAKOTA HILLS NO. 1, A PLAT OF RECORD IN THE COUNTY OF WASHINGTON AND STATE OF OREGON; THENCE ALONG THE SOUTH LINE OF LOT 123, DAKOTA HILLS NO. 1, NORTH 89 DEGREES 27'50" EAST, 75.00 FEET TO THE SOUTHEAST CORNER OF SAID LOT 123; THENCE SOUTH 00 DEGREES 08'59" EAST, 20.00 FEET TO A 5/8 INCH X 30 INCH IRON ROD WITH YELLOW PLASTIC CAP STAMPED "COMPASS CORP."; THENCE ALONG A LINE PARALLEL TO AND 20 FEET SOUTH OF THE SOUTH LINE OF LOT 123, DAKOTA HILLS NO. 1, SOUTH 89 DEGREES 27'50" WEST, 75.00 FEET TO A 5/8 INCH X 30 INCH IRON ROD WITH YELLOW PLASTIC CAP STAMPED "COMPASS CORP."; THENCE NORTH 00 DEGREES 08'59" WEST, 20.00 FEET TO THE POINT OF BEGINNING.

AND ALSO FURTHER EXCEPTING THEREFROM:

A PARCEL OF LAND SITUATED IN THE NORTHEAST ONE-QUARTER OF SECTION 35, TOWNSHIP 2 SOUTH, RANGE 1 WEST OF THE WILLAMETTE MERIDIAN, IN THE COUNTY OF WASHINGTON AND STATE OF OREGON, BEING MORE PARTICULARLY DESCRIBED AS FOLLOWS:

BEGINNING AT THE SOUTHWEST CORNER OF LOT 122, DAKOTA HILLS NO. 1, A PLAT OF RECORD IN WASHINGTON COUNTY, OREGON; THENCE ALONG THE SOUTH LINE OF LOT 122, DAKOTA HILLS NO. 1, NORTH 89°27'50" EAST, 86.47 FEET TO THE SOUTHEAST CORNER OF SAID LOT 122; THENCE ALONG A SOUTHERLY PROJECTION OF THE WEST LINE OF S.W. MARTINAZZI AVENUE SOUTH 11°32'00" WEST, 20.45 FEET TO A 5/8 INCH X 30 INCH IRON ROD WITH YELLOW PLASTIC CAP STAMPED "COMPASS CORP."; THENCE ALONG A LINE PARALLEL TO AND 20 FEET SOUTH OF THE SOUTH LINE OF LOT 122, DAKOTA HILLS NO. 1, SOUTH 89°27'50" WEST, 82.33 FEET TO A 5/8 INCH X 30 INCH IRON ROD WITH YELLOW PLASTIC CAP STAMPED "COMPASS CORP."; THENCE NORTH 00°08'59" WEST, 20.00 FEET TO THE POINT OF BEGINNING.

AND ALSO FURTHER EXCEPTING THEREFROM THE FOLLOWING DESCRIBED PARCEL:

BEGINNING AT A POINT ON THE SOUTH LINE OF TRACT "B", PLAT OF DAKOTA HILLS AS RECORDED IN PLAT BOOK 43, PAGES 7-8, PLAT RECORDS SAID COUNTY, SAID POINT BEING SOUTH 89°29'06" WEST ON THE SOUTH LINE OF SAID PLAT A DISTANCE OF 94.12 FEET FROM THE NORTHWEST CORNER OF LOT 184 OF DAKOTA HILLS NO. 2 AS RECORDED IN PLAT BOOK 53, PAGES 5-6, PLAT RECORDS SAID COUNTY, SAID POINT ALSO BEING THE NORTHEAST CORNER OF THAT PARCEL DESCRIBED IN FEE NO. 87-44953 AND RUNNING THENCE SOUTH 0°07'46" EAST ON THE EAST LINE SAID PARCEL A DISTANCE OF 971.55 FEET TO THE SOUTHEAST CORNER THEREOF; THENCE SOUTH 89°27'46" WEST ON THE SOUTH LINE SAID PARCEL A DISTANCE OF 10.00 FEET; THENCE NORTH 0°07'46" WEST PARALLEL WITH AND 10.00 FEET WEST OF SAID EAST LINE A DISTANCE OF 971.56 FEET TO A POINT ON THE SOUTH LINE OF AFOREMENTIONED TRACT B; THENCE NORTH 89°29'06" EAST ON SAID SOUTH LINE A DISTANCE OF 10.00 FEET TO THE POINT OF BEGINNING.

AND ALSO FURTHER EXCEPTING THEREFROM THOSE PARCELS DESCRIBED IN DEDICATION DEEDS TO THE CITY OF TUALATIN RECORDED JUNE 1, 1990 AS FEE NO. 90-28255 AND APRIL 22, 1993 AS FEE NO. 93030706.

PARCEL II:

THAT PORTION OF THE NORTHEAST QUARTER OF SECTION 35, TOWNSHIP 2 SOUTH, RANGE 1 WEST OF THE WILLAMETTE MERIDIAN IN THE CITY OF TUALATIN, THE COUNTY OF WASHINGTON AND STATE OF OREGON, DESCRIBED AS FOLLOWS:

BEGINNING AT A POINT IN THE CENTER OF STATE HIGHWAY #217, AT THE SOUTHWEST CORNER OF THAT CERTAIN TRACT OF LAND CONVEYED TO WALTER J. MOHR, BY DEED RECORDED ON PAGE 201, IN BOOK 258, WASHINGTON COUNTY OREGON DEED RECORDS; WHICH BEGINNING POINT BEARS SOUTH 0° 05 1/2' EAST 731.7 FEET FROM THE QUARTER CORNER ON THE NORTH LINE OF SAID SECTION 35; THENCE ALONG THE SOUTH LINE OF THE SAID MOHR TRACT, NORTH 89° 30' EAST 957.0 FEET TO AN IRON PIPE; THENCE SOUTH 29° 35' EAST 274.9 FEET TO AN IRON PIPE AT THE SOUTHERLY SOUTHWEST CORNER OF THE SAID MOHR TRACT; THENCE NORTH 89° 30' EAST ALONG THE SOUTH LINE OF THE SAID MOHR TRACT AND THE EASTERLY EXTENSION THEREOF 887.7 FEET, MORE OR LESS, TO ITS INTERSECTION WITH THE NORTHERLY EXTENSION OF THE EASTERLY LINE OF THE 5.0 ACRE TRACT OF LAND CONVEYED TO FLOSSIE D. KING, BY DEED RECORDED ON PAGE 343, IN BOOK 242, SAID DEED RECORDS; THENCE SOUTH 0° 05 1/2' EAST 823.3 FEET, MORE OR LESS, TO THE NORTHEAST CORNER OF THE SAID 5.0 ACRE TRACT; THENCE SOUTH 89° 37' WEST 1320.0 FEET TO A IRON PIPE AT THE NORTHWEST CORNER OF THAT CERTAIN 20 ACRE TRACT CONVEYED TO FLOSSIE KING BY DEED RECORDED ON PAGE 549, IN BOOK 238, SAID DEED RECORDS, SAID CORNER BEING ON THE EAST LINE OF THAT CERTAIN TRACT OF LAND CONVEYED TO JOHN D. SMITH, BY DEED RECORDED ON PAGE 479, BOOK 237, SAID DEED RECORDS; THENCE ALONG THE BOUNDARY OF SAID SMITH PARCEL NORTH 0° 05 1/2' WEST 429.0 FEET TO AN IRON PIPE AT THE NORTHEAST CORNER OF SAID TRACT CONVEYED TO SMITH, AND NORTH 87° 31' WEST 660.8 FEET TO THE NORTHWEST CORNER OF THE SAID SMITH TRACT IN THE CENTER OF SAID HIGHWAY; THENCE NORTH 0° 05 1/2' WEST 597.55 FEET TO THE PLACE OF BEGINNING.

EXCEPTING THEREFROM THAT PORTION DESCRIBED AS FOLLOWS:

BEGINNING AT AN IRON STAKE IN THE CENTER OF SAID STATE HIGHWAY NO. 217 AT THE NORTHWEST CORNER OF THAT CERTAIN PARCEL OF LAND CONVEYED TO JOHN D. SMITH, RECORDED NOVEMBER 29, 1944 IN BOOK 237, PAGE 479, WASHINGTON COUNTY DEED RECORDS; THENCE NORTH ALONG THE CENTERLINE OF SAID HIGHWAY 217 A DISTANCE OF 105 FEET; THENCE SOUTH 87° 31' EAST PARALLEL TO THE NORTH LINE OF SAID SMITH PARCEL A DISTANCE OF 235 FEET; THENCE SOUTH PARALLEL TO THE CENTERLINE OF SAID HIGHWAY NO. 217 A DISTANCE OF 105 FEET TO THE NORTH LINE OF SAID SMITH PARCEL; THENCE NORTH 87° 31' WEST ALONG SAID NORTH LINE 235 FEET TO THE POINT OF BEGINNING.

AND ALSO EXCEPTING THEREFROM:

A TRACT OF LAND SITUATED IN THE NORTHEAST ONE-QUARTER OF SECTION 35, TOWNSHIP 2 SOUTH, RANGE 1 WEST OF THE WILLAMETTE MERIDIAN, WASHINGTON COUNTY, OREGON, BEING A PART OF THAT CERTAIN TRACT OF LAND DESCRIBED IN FEE NO. 87-044953, WASHINGTON COUNTY RECORDS, BEING MORE PARTICULARLY DESCRIBED AS FOLLOWS:

BEGINNING AT A 5/8" IRON ROD AT THE SOUTHWEST CORNER OF LOT 219, "DAKOTA HILLS NO. 3"; THENCE NORTH 89 DEGREES 27'46" EAST ALONG THE SOUTH LINE OF SAID LOT 219 A DISTANCE OF 103.62 FEET TO THE SOUTHEAST CORNER THEREOF; THENCE SOUTH 00 DEGREES 06'00" EAST ALONG THE WEST LINE OF LOT 220, "DAKOTA HILLS NO. 3", 17.47 FEET TO THE SOUTHWEST CORNER THEREOF; THENCE SOUTH 89 DEGREES 27'46" WEST PARALLEL WITH THE SOUTH LINE OF SAID LOT 219 A DISTANCE OF 103.61 FEET TO A 5/8" IRON ROD; THENCE NORTH 00 DEGREES 07'46" WEST 17.47 FEET TO THE POINT OF BEGINNING.

AND ALSO EXCEPTING THEREFROM:

A PARCEL OF LAND LYING IN THE NORTHEAST 1/4 OF SECTION 35, TOWNSHIP 2 SOUTH, RANGE 1 WEST, WILLAMETTE MERIDIAN, CITY OF TUALATIN, WASHINGTON COUNTY, OREGON AND BEING A PORTION OF THAT PROPERTY DESCRIBED IN WARRANTY DEED TO TIGARD SCHOOL DISTRICT 23J, RECORDED SEPTEMBER 01, 1987 AS DOCUMENT NUMBER 87044953 AND IN SPECIAL WARRANTY DEED RECORDED DECEMBER 16, 1987 AS DOCUMENT NUMBER 87061514, WASHINGTON COUNTY DEED RECORDS; THE SAID PARCEL BEING THAT PORTION OF SAID PROPERTY INCLUDED IN A STRIP OF LAND 51.00 FEET IN WIDTH LYING ON THE EAST SIDE OF THE CENTERLINE OF S.W. BOONES FERRY ROAD, WHICH CENTER LINE IS DESCRIBED AS FOLLOWS:

BEGINNING AT A 3/4 INCH DIAMETER IRON PIPE MARKING THE CENTER OF SAID SECTION 35, SAID POINT BEING ON THE CENTER LINE OF S.W. BOONES FERRY ROAD AT ENGINEER'S STATION 377+03.62; THENCE FROM SAID POINT OF BEGINNING ALONG THE CENTER LINE OF SAID SECTION 35 AND ALONG THE CENTER LINE OF S.W. BOONES FERRY ROAD NORTH 00°05'16" WEST 2304.55 TO ENGINEER'S STATION 353+99.07; THENCE ALONG A 716.20 FOOT RADIUS CURVE RIGHT (THE LONG CHORD OF WHICH BEARS NORTH 12°48'55" EAST 319.86 FEET) 322.58 FEET TO ENGINEER'S STATION 350+76.49.

EXCEPTING THERE FROM ALL THAT PORTION LYING WITHIN THE EXISTING RIGHT OF WAY OF S.W. BOONES FERRY ROAD.

THE BEARINGS AND CENTERLINE DATA ARE BASED ON SURVEY NO. 28293, WASHINGTON COUNTY SURVEY RECORDS.



First American

First American Title Company of Oregon

121 SW Morrison Street, Suite 300

Portland, OR 97204

Phone: (503)222-3651 / Fax: (877)242-3513

PR: NWEST

Ofc: 7019 (1011)

Final Invoice

To: Tigard-Tualatin School District 23J
6960 SW Sandburg Street
Tigard, OR 97223

Invoice No.: 1011 - 7019142192

Date: 10/04/2017

Our File No.: 7019-2944125

Title Officer: Dona Cramer

Escrow Officer:

Customer ID: 6959356

Attention: Sarah Mehrabzadeh

Liability Amounts

Your Ref.:

Owners:

RE: Property:
22300 SW Boones Ferry Road, Tualatin, OR 97062

Lenders:

Buyers:

Sellers: Tigard-Tualatin School District 23J

Description of Charge	Invoice Amount
Report: Lot Book	\$300.00

INVOICE TOTAL **\$300.00**

Comments:

Thank you for your business!

To assure proper credit, please send a copy of this Invoice and Payment to:

Attention: Accounts Receivable Department

PO Box 31001-2266

Pasadena, CA 91110-2266

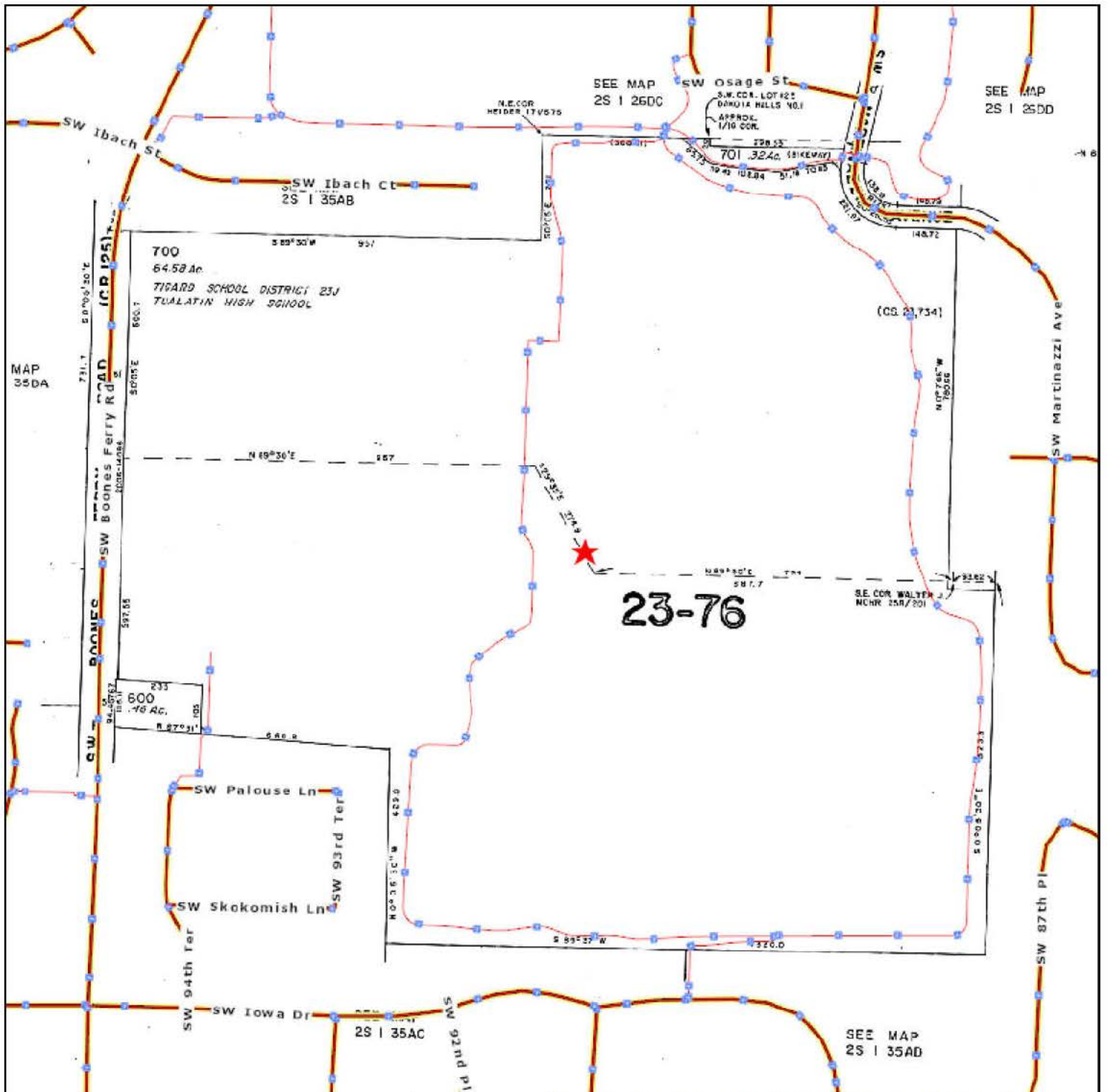

First American Title

This map/plat is being furnished as an aid in locating the herein described land in relation to adjoining streets, natural boundaries and other land, and is not a survey of the land depicted. Except to the extent a policy of title insurance is expressly modified by endorsement, if any, the company does not insure dimensions, distances, location of easements, acreage or other matters shown thereon.

geoAdvantage

SPECIAL WARRANTY DEED

MECCA INTERNATIONAL, LTD., an Oregon corporation, Grantor, conveys and specially warrants to the TIGARD SCHOOL DISTRICT, Grantee, the following described real property:

SEE EXHIBIT A

Free of all encumbrances created or suffered by Grantor, excepting those identified on Exhibit B.

The true consideration for this conveyance is \$ 990,000.00.

THIS INSTRUMENT WILL NOT ALLOW USE OF THE PROPERTY DESCRIBED IN THIS INSTRUMENT IN VIOLATION OF APPLICABLE LAND USE LAWS AND REGULATIONS. BEFORE SIGNING OR ACCEPTING THIS INSTRUMENT, THE PERSON ACQUIRING FEE TITLE TO THE PROPERTY SHOULD CHECK WITH THE APPROPRIATE CITY OR COUNTY PLANNING DEPARTMENT TO VERIFY APPROVED USES.

Dated this 16 day of December, 1987.

GRANTOR:

MECCA INTERNATIONAL, LTD., an Oregon corporation

By: [Signature]

By: [Signature]

STATE OF OREGON)
) ss.
County of Multnomah)

Personally appeared before me this 16th day of December, 1987, the above named Fred Bachofner and John Draneas, who did say that they are the Vice President and Assistant Secretary, respectively, of Mecca International, Ltd., that they signed the foregoing deed by authority of its Board of Directors, and acknowledged the same to be their voluntary act and deed.



[Signature]
Notary Public for Oregon
My Commission Expires: 7-22-90

After Recording Return to:

TIGARD SCHOOL DISTRICT
C/o Mr. Richard A. Cantlin
Miller, Nash, Wiener, Hager &
Carlsen,
111 S. W. 5th
Portland, Oregon 97204

UNTIL A CHANGE IS REQUESTED,
all tax statements shall be
sent to: TIGARD SCHOOL DISTRICT
13137 S. W. Pacific Highway
Tigard, Oregon 97223

Recorded by
First American Title Insurance Company of Oregon
No. 363109

SPECIAL WARRANTY DEED
B10.04

1-3

EXHIBIT "A"

That portion of the Northeast quarter of Section 35, Township 2 South, Range 1 West of the Willamette Meridian in the County of Washington and State of Oregon, described as follows:

Beginning at a point in the center of State Highway #217, at the Southwest corner of that certain tract of land conveyed to Walter J. Mohr, by deed recorded on page 201, in Book 258, Washington County Oregon Deed Records; which beginning point bears South 0° 05 1/2' East 731.7 feet from the quarter corner on the North line of said Section 35; thence along the South line of the said Mohr tract North 89° 30' East 957.0 feet to an iron pipe; thence South 29° 35' East 274.9 feet to an iron pipe at the Southerly Southwest corner of the said Mohr tract; thence North 89° 30' East along the South line of the said Mohr tract and the Easterly extension thereof 887.7 feet, more or less, to its intersection with the Northerly extension of the Easterly line of the 5.0 acre tract of land conveyed to Flossie D. King, by deed recorded on page 343, in Book 242, said Deed Records; thence South 0° 05 1/2' East 823.3 feet, more or less, to the Northeast corner of the said 5.0 acre tract; thence South 89° 37' West 1320.0 feet to a iron pipe at the Northwest corner of that certain 20 acre tract conveyed to Flossie King by deed recorded on page 549, in Book 238, said Deed Records, said corner being on the East line of that certain tract of land conveyed to John D. Smith, by deed recorded on page 479, Book 237, said Deed Records; thence along the boundary of said Smith parcel North 0° 05 1/2' West 429.0 feet to an iron pipe at the Northeast corner of said tract conveyed to Smith, and North 87° 31' West 660.8 feet to the Northwest corner of the said Smith tract in the center of said Highway; thence North 0° 05 1/2' West 597.55 feet to the place of beginning.

EXCEPTING THEREFROM that portion described as follows:

Beginning at an iron stake in the center of said State Highway No. 217 at the Northwest corner of that certain parcel of land conveyed to John D. Smith, recorded November 29, 1944 in Book 237, page 479, Washington County Deed Records; thence North along the centerline of said Highway 217 a distance of 105 feet; thence South 87° 31' East parallel to the North line of said Smith Parcel a distance of 235 feet; thence South parallel to the centerline of said Highway No. 217 a distance of 105 feet to the North line of said Smith Parcel; thence North 87° 31' West along said North line 235 feet to the point of beginning.

2

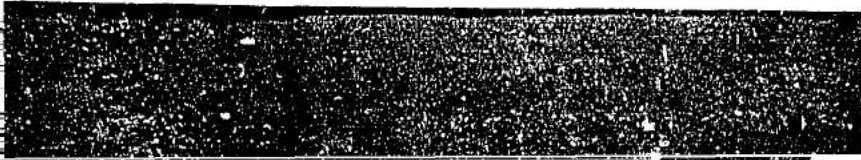

EXHIBIT B

LIENS AND ENCUMBRANCES

1. Any obligations to Leonard A. Pohl and Juanita G. Pohl pursuant to the land sale contract entered into on December 1, 1978 between them and Lutz Development Co., an Oregon corporation, and recorded December 4, 1978 as Fee No. 78052885, as amended on May 23, 1983 and April 1, 1984, other than the payment of the purchase price, that survive the delivery of the deed by Leonard A. Pohl and Juanita G. Pohl pursuant to such land sale contract and amendments.
2. Any lien for additional property taxes that may become due as a result of the disqualification of the property for special assessment as "Farm Land".
3. City Lien in favor of the City of Tualatin.
For : Water improvements
Account No. : 1379WA0009
Dated : September 13, 1982
Ordinance No. : 575
Original Amount : \$83,092.63
Balance Owning : \$52,874.73 plus interest, if any.
4. The rights of the public in and to that portion of the premises herein described lying within the limits of public roads.

STATE OF OREGON }
County of Washington } SS

I, Donald W. Mason, Director of Assessment and Taxation and Ex-Officio Recorder of Conveyances for said county, do hereby certify that the within instrument of writing was received and recorded in book of records of said county.

Donald W. Mason, Director of Assessment and Taxation, Ex-Officio County Clerk

SPECIAL WARRANTY DEED
B10.04

3

1987 DEC 16 PM 4:09

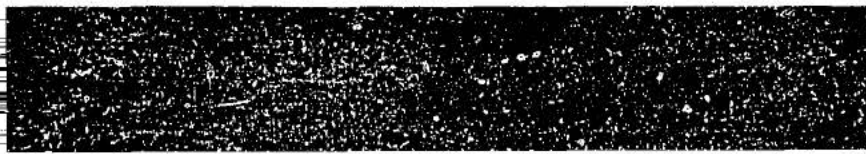

Sensitive Area Pre-Screening Site Assessment

1. Jurisdiction: Tualatin

2. Property Information (example 1S234AB01400)

Tax lot ID(s): 2S135A000700

Site Address: 22300 SW Boones Ferry Rd

City, State, Zip: Tualatin, OR, 97062

Nearest Cross Street: SW Ibach Court

3. Owner Information

Name: Ernie Brown

Company: Tigard-Tualatin School District No. 23J

Address: 6960 SW Sandburg Street

City, State, Zip: Tigard, OR, 97223

Phone/Fax: _____

E-Mail: ebrown@ttsd.k12.or.us

4. Development Activity (check all that apply)

- Addition to Single Family Residence (rooms, deck, garage)
- Lot Line Adjustment Minor Land Partition
- Residential Condominium Commercial Condominium
- Residential Subdivision Commercial Subdivision
- Single Lot Commercial Multi Lot Commercial
- Other _____

5. Applicant Information

Name: Kelly Youngberg

Company: Cardno

Address: 6720 SW Macadam Ave, Suite 200

City, State, Zip: Portland, OR, 97219

Phone/Fax: 503-200-2388

E-Mail: kelly.youngberg@cardno.com

6. Will the project involve any off-site work? Yes No Unknown

Location and description of off-site work _____

7. Additional comments or information that may be needed to understand your project _____

This application does NOT replace Grading and Erosion Control Permits, Connection Permits, Building Permits, Site Development Permits, DEQ 1200-C Permit or other permits as issued by the Department of Environmental Quality, Department of State Lands and/or Department of the Army COE. All required permits and approvals must be obtained and completed under applicable local, state, and federal law.

By signing this form, the Owner or Owner's authorized agent or representative, acknowledges and agrees that employees of Clean Water Services have authority to enter the project site at all reasonable times for the purpose of inspecting project site conditions and gathering information related to the project site. I certify that I am familiar with the information contained in this document, and to the best of my knowledge and belief, this information is true, complete, and accurate.

Print/Type Name Kelly Youngberg Print/Type Title Civil Designer

ONLINE SUBMITTAL

Date 9/22/2017

FOR DISTRICT USE ONLY

- Sensitive areas potentially exist on site or within 200' of the site. **THE APPLICANT MUST PERFORM A SITE ASSESSMENT PRIOR TO ISSUANCE OF A SERVICE PROVIDER LETTER.** If Sensitive Areas exist on the site or within 200 feet on adjacent properties, a Natural Resources Assessment Report may also be required.
- Based on review of the submitted materials and best available information Sensitive areas do not appear to exist on site or within 200' of the site. This Sensitive Area Pre-Screening Site Assessment does NOT eliminate the need to evaluate and protect water quality sensitive areas if they are subsequently discovered. This document will serve as your Service Provider letter as required by Resolution and Order 17-05, Section 3.02.1. All required permits and approvals must be obtained and completed under applicable local, State, and federal law.
- Based on review of the submitted materials and best available information the above referenced project will not significantly impact the existing or potentially sensitive area(s) found near the site. This Sensitive Area Pre-Screening Site Assessment does NOT eliminate the need to evaluate and protect additional water quality sensitive areas if they are subsequently discovered. This document will serve as your Service Provider letter as required by Resolution and Order 07-20, Section 3.02.1. All required permits and approvals must be obtained and completed under applicable local, state and federal law.
- This Service Provider Letter is not valid unless _____ CWS approved site plan(s) are attached.**
- The proposed activity does not meet the definition of development or the lot was platted after 9/9/95 ORS 92.040(2). **NO SITE ASSESSMENT OR SERVICE PROVIDER LETTER IS REQUIRED.**

Reviewed by _____ Date 9/27/17

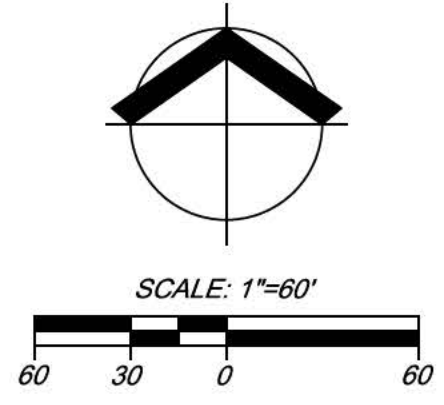

PROPOSED LEGEND

- CURB LINE
- AC PAVEMENT SURFACE
- CONCRETE SURFACE
- STORMWATER FACILITY
- RETAINING WALL HATCH
- GRAVEL PATHWAY SURFACE
- LIMITS OF IMPROVEMENT AREA

PROPOSED SITE IMPROVEMENT NOTES

- 1 CONSTRUCT ASPHALT CONCRETE SURFACE FOR FIRE LANE ACCESS.
- 2 CONSTRUCT 6 INCH STANDARD EXPOSURE CURB.
- 3 CONSTRUCT ASPHALT EDGE FLUSH WITH STRUCTURE FINISHED FLOOR ELEVATION FOR TRUCK LOADING.
- 4 CONSTRUCT CONCRETE SURFACE FOR PEDESTRIAN LOADING.
- 5 CONSTRUCT 18 INCH HIGH CONCRETE SEAT WALL.
- 6 INSTALL STORMWATER TREATMENT FACILITY.
- 7 INSTALL LANDSCAPING. SEE LANDSCAPE PLANS.
- 8 INSTALL PROPOSED SITE FURNITURE.
- 9 INSTALL TREE WELLS.
- 10 CONSTRUCT NEW SYNTHETIC TURF SECTION.
- 11 RESURFACE TENNIS COURT.
- 12 CONSTRUCT PROPOSED CONCRETE PEDESTRIAN RAMP.
- 13 CONSTRUCT RETAINING WALL BETWEEN PROPOSED ADA RAMP AND ASPHALT ACCESS ROUTE.
- 14 INSTALL ADA COMPLIANT HANDRAIL ON BOTH SIDES OF THE RAMP FOR THE LENGTH OF THE ENTIRE RAMP.
- 15 CONSTRUCT PERIMETER CURB WITH TURF NAILING BOARD.
- 16 CONSTRUCT GRAVEL PATHWAY.
- 17 INSTALL SLOT DRAINS. OUTFALL TO EXISTING STORMWATER TREATMENT FACILITY.
- 18 INSTALL LANDSCAPING. SEE LANDSCAPE PLANS.
- 19 INSTALL STORMWATER TREATMENT FACILITY.
- 20 INSTALL STORMWATER CONVEYANCE DITCH.
- 21 CONSTRUCT ASPHALT CONCRETE SURFACE.
- 22 CONSTRUCT ASPHALT THICKENED EDGE.
- 14 CONSTRUCT CONCRETE SLAB.

GENERAL NOTES

IMPROVEMENTS WITHIN LIMIT OF WORK ALSO INCLUDE BULL PEN, CONCESSIONS STAND SOFTBALL BATTING CAGE AND TALL FENCING.

#	REVISIONS	DATE

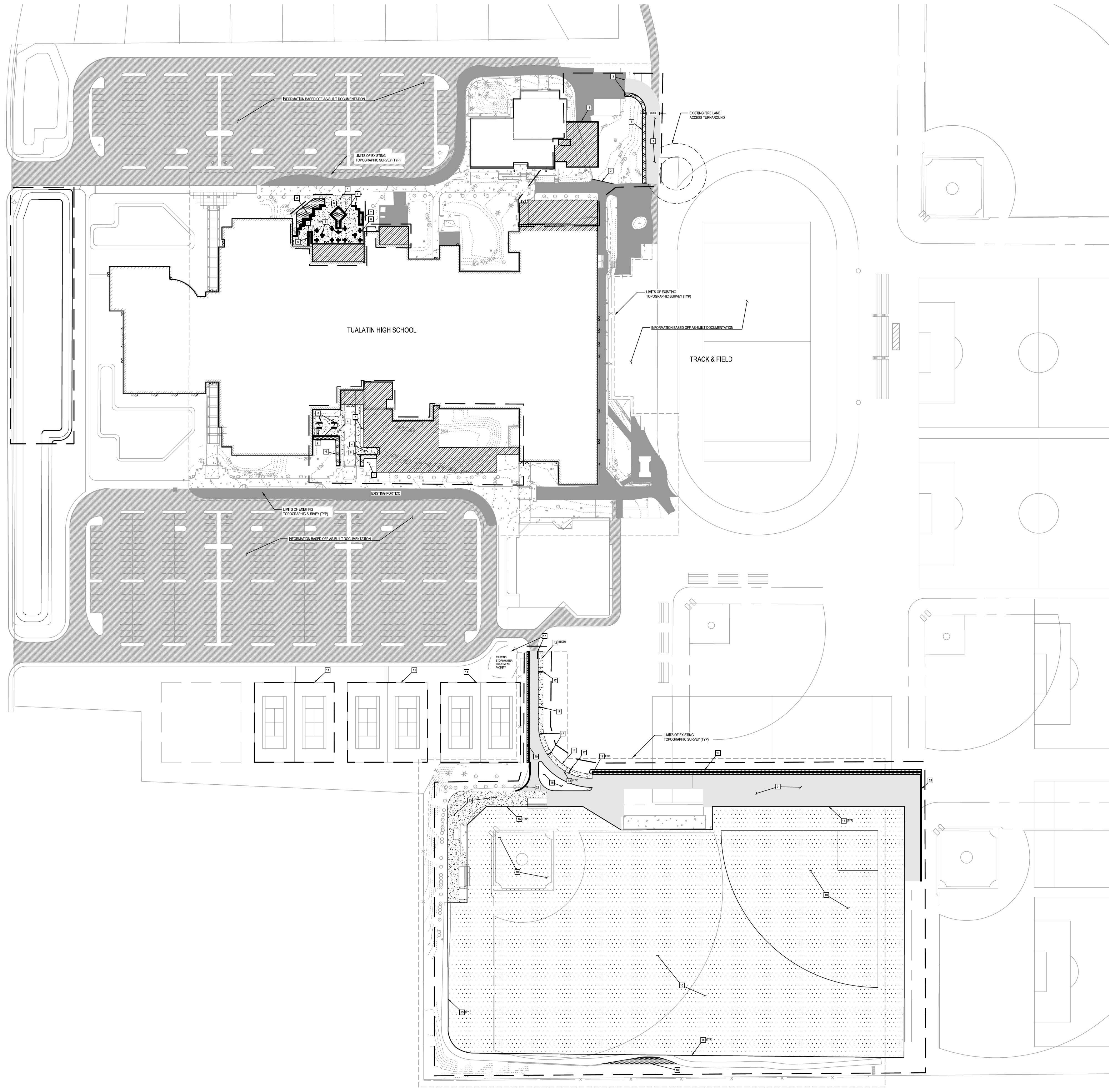

100% SCHEMATIC DESIGN - DRAFT

TIGARD TUALATIN SD
TUALATIN HIGH SCHOOL

22300 SW BOONES FERRY RD.
TUALATIN, OR 97062

JOB NO: 21612290
ISSUE DATE: 08/22/2017
Jurisdiction Stamp Area

SITE PLAN



September 20, 2017

5415 SW Westgate Drive
Suite 100
Portland, Oregon 97221
USA

Phone: (503) 419-2500
Fax: (503) 419-2600

www.cardno.com

RE: Tualatin High School

Dear Interested Party:

Cardno and Day CPM are agents representing the Tigard-Tualatin School District, who is the owner of Tualatin High School in Tualatin, OR. The Tualatin High School property is at 22300 SW Boones Ferry Road and is legally identified as Parcel 2S135AB00700. The school currently operates as a school, and the owner is proposing to continue as the same use as part of a proposed redevelopment plan. The proposal includes a combination of new additions and interior renovations distributed across the existing school campus, with some exterior plaza renovations also included. Interior renovations are proposed for existing commons, lockers, library, and existing administration areas, however, these areas will not affect the project site footprint. A Site Plan is included with this letter that conveys existing conditions on the site and the general scope of the proposed redevelopment plan.

As part of review by the City of Tualatin, an Architectural Review land use application is required prior to building permit review. Prior to applying to the City of Tualatin for the necessary land use approvals, our team would like to discuss the proposal in more specific details with the surrounding property owners and residents. Thereby, you are invited to attend a neighborhood meeting with other surrounding residents and the development team. The meeting details are as follows:

Thursday, October 5, 2017
6:00 pm – 8:00 pm
Tualatin High School Library
22300 SW Boones Ferry Road
Tualatin, OR 97062

Please note that this will be an informational meeting on preliminary development plans, and that these plans may be altered prior to submittal of the application package to the City.

We look forward to discussing the proposal with you. If you have any questions prior to the meeting, please call Cathy Kraus at Day CPM at 503-913-3777, or Kevin Brady at Cardno at 503-419-2500.

Sincerely,

Kevin Brady
Senior Planner

**NEIGHBORHOOD / DEVELOPER MEETING
CERTIFICATION OF SIGN POSTING**

<p>NOTICE</p> <p>NEIGHBORHOOD / DEVELOPER MEETING</p> <p>__/__/2010 __:__.m.</p> <p>SW _____</p> <p>503-__-__</p>

18"

24"

In addition to the requirements of TDC 31.064(2) quoted earlier in the packet, the 18" x 24" sign that the applicant provides must display the meeting date, time, and address and a contact phone number. The block around the word "NOTICE" must remain **orange** composed of the **RGB color values Red 254, Green 127, and Blue 0**. Additionally, the potential applicant must provide a flier (or flyer) box on or near the sign and fill the box with brochures reiterating the meeting info and summarizing info about the potential project, including mention of anticipated land use application(s). Staff has a Microsoft PowerPoint 2007 template of this sign design available through the Planning Division homepage at < www.tualatinoregon.gov/planning/land-use-application-sign-templates >.

As the applicant for the

Tualatin High School project, I

hereby certify that on this day, 2 sign(s) was/were posted on the subject property in accordance with the requirements of the Tualatin Development Code and the Community Development Department - Planning Division.

Applicant's Name: Kevin Brady
(PLEASE PRINT)

Applicant's Signature: *Kevin Brady*

Date: September 21, 2017

**NEIGHBORHOOD/DEVELOPER MEETING
AFFIDAVIT OF MAILING**

STATE OF OREGON)
) SS
COUNTY OF WASHINGTON)

I, Kevin Brady, being first duly sworn, depose and say:

That on the 21st day of September, 2017, I served upon the persons shown on Exhibit "A," attached hereto and by this reference incorporated herein, a copy of the Notice of Neighborhood/Developer meeting marked Exhibit "B," attached hereto and by this reference incorporated herein, by mailing to them a true and correct copy of the original hereof. I further certify that the addresses shown on said Exhibit "A" are their regular addresses as determined from the books and records of the Washington County and/or Clackamas County Departments of Assessment and Taxation Tax Rolls, and that said envelopes were placed in the United States Mail with postage fully prepared thereon.

Signature

SUBSCRIBED AND SWORN to before me this 21st day of September, 2017.



Notary Public for Oregon
My commission expires: September 23, 2019

RE: Tualatin HS AR - N/D meeting notice

MEETING SIGN-IN SHEET	Meeting Date: Thursday, October 5, 2017, 6:00 - 8:00 pm
Facilitator: Day CPM, Cardno, Bassetti	Tualatin High School Library 223000 SW Boones Ferry Road Tualatin, OR 97062

Name (print)	Phone number (optional)	E-Mail (optional)	Athletic Fields Meetings (?)
Kevin Brady			✓
CARY DASENBROOK			✓
Joe Echeverri			
Jill Zurschmeide			2. ✓ of us
Holly Stuart			✓
Carla Wieting			✓
Alberta Fry			✓
JOEL AUGEE			✓
Dave Garrett			✓
Charles Glaeser			✓
JIMMY CARBAJAL			✓
REGINA CARBAJAL			✓
Elizabeth Michels			✓

NEIGHBORHOOD MEETING NOTES

**TUALATIN HS PROJECT
TUALATIN HIGH SCHOOL LIBRARY
OCTOBER 5, 2017, 6-7 PM**

Day CPM – Cathy Kraus and Debbie Pearson

Cardno – Kevin Brady and Matt Lewis

Bassetti – architectural team, including Cary Dasenbrock (presenter)

- Day CPM provided project overview and indication that athletic fields discussion would be done through series of outreach meetings during October and November. These meetings would focus on renovation of existing building.
- DAY CPM further clarified these meetings, indicating an anticipated 3-step stakeholder involvement process: 1) input from stakeholders; 2) present 2 options that address input for feedback; and 3) present outcome solution. District's goal is to have design direction by 11/15/17.
- Cardno provided a sign in sheet that allowed people to indicate their interest in participating in these other meetings.
- Cardno explained that the athletics fields project would be a separate Neighborhood/Developer Meeting and would be required by the City. This would also be a separate application for AR, unless it could be included with the existing application. However, second N/D still needed for athletic fields discussion.
- Bassetti provided a presentation, with both an overview and specifics of the renovation and addition project.
- Neighbors asked about canopy on the North side of the building: neighbors asked about this element.
- Team shared that all PE/Athletics locker room/team room improvements need to meet Title 9.
- Cardno explained retention of fire lanes.
- Cardno explained changes to storm water facility at front of site along SW Boones Ferry Road.
- Team explained retention of existing maintenance buildings.
- Bassetti explained potential to either add onto or remove existing canopy features. Final design to be reviewed in AR application by the City.



November 1, 2017

6720 SW Macadam Ave.
Suite 200
Portland, OR 97219

Phone (503) 419-2500
Fax (503) 419-2600

www.cardno.com

RE: Tualatin High School Athletic Fields

Dear Interested Party:

Cardno and Day CPM are agents representing the Tigard-Tualatin School District, who is the owner of Tualatin High School in Tualatin, OR. The Tualatin High School property is at 22300 SW Boones Ferry Road and is legally identified as Parcel 2S135AB00700. The school currently operates as a school, and the owner is proposing to continue as the same use as part of a proposed redevelopment plan. The first part of the proposal includes a combination of new additions and interior renovations distributed across the existing school campus, with some exterior plaza renovations also included. This portion of the project is currently under Architectural Review with the City of Tualatin. The second portion of the project includes changes to the athletic fields at the southern portion of the site. Site plans and other material will be made available at the meeting that convey existing conditions on the site and the general scope of the proposed redevelopment plan for the athletic fields.

As part of review by the City of Tualatin, an Architectural Review land use application for the athletic fields portion of the project is required prior to building permit review. Prior to applying to the City of Tualatin for the necessary land use approvals, our team would like to continue to discuss the proposal in more specific details with the surrounding property owners and residents. Thereby, you are invited to attend a neighborhood meeting with other surrounding residents and the development team. The meeting details are as follows:

**Wednesday, November 15, 2017
6:00 pm – 8:00 pm
Tualatin High School Library
22300 SW Boones Ferry Road
Tualatin, OR 97062**

Please note that this will be an informational meeting on preliminary development plans, and that these plans may be altered prior to submittal of the application package to the City.

We look forward to discussing the proposal with you. If you have any questions prior to the meeting, please call Cathy Kraus at Day CPM at 503-913-3777, or Kevin Brady at Cardno at 503-419-2500.

Sincerely,

Kevin Brady
Senior Planner

NEIGHBORHOOD / DEVELOPER MEETING CERTIFICATION OF SIGN POSTING

<p style="text-align: center;">NOTICE</p> <p style="text-align: center;">NEIGHBORHOOD / DEVELOPER MEETING</p> <p style="text-align: center;">__/__/2010 __:__.m.</p> <p style="text-align: center;">SW _____</p> <p style="text-align: center;">503-__-__</p>	18"
24"	

In addition to the requirements of TDC 31.064(2) quoted earlier in the packet, the 18" x 24" sign that the applicant provides must display the meeting date, time, and address and a contact phone number. The block around the word "NOTICE" must remain **orange** composed of the **RGB color values Red 254, Green 127, and Blue 0**. Additionally, the potential applicant must provide a flier (or flyer) box on or near the sign and fill the box with brochures reiterating the meeting info and summarizing info about the potential project, including mention of anticipated land use application(s). Staff has a Microsoft PowerPoint 2007 template of this sign design available through the Planning Division homepage at < www.tualatinoregon.gov/planning/land-use-application-sign-templates >.

As the applicant for the

Tualatin HS (athletic fields) project, I

hereby certify that on this day, November 1st sign(s) was/were posted on the subject property in accordance with the requirements of the Tualatin Development Code and the Community Development Department - Planning Division.

Applicant's Name: Kevin Brady
(PLEASE PRINT)

Applicant's Signature: *Kevin Brady*

Date: 11/1/10

**NEIGHBORHOOD/DEVELOPER MEETING
AFFIDAVIT OF MAILING**

STATE OF OREGON)
) SS
COUNTY OF WASHINGTON)

I, Kevin Brady, being first duly sworn, depose and say:

That on the 15th day of November, 2017, I served upon the persons shown on Exhibit "A," attached hereto and by this reference incorporated herein, a copy of the Notice of Neighborhood/Developer meeting marked Exhibit "B," attached hereto and by this reference incorporated herein, by mailing to them a true and correct copy of the original hereof. I further certify that the addresses shown on said Exhibit "A" are their regular addresses as determined from the books and records of the Washington County and/or Clackamas County Departments of Assessment and Taxation Tax Rolls, and that said envelopes were placed in the United States Mail with postage fully prepared thereon.



Signature

SUBSCRIBED AND SWORN to before me this 15th day of November, 2017.





Notary Public for Oregon
My commission expires: September 23, 2019

RE: Tualatin HS

MEETING MINUTES



Project: Tualatin HS Bond Improvements
Re: Athletic Facility Amenities

Location: TuHS Resource Center
Date: November 15, 2017
6:00 pm

Cardno#: 2161229000

Presenters: Debbie Pearson – Day CPM
Matt Lewis - Cardno

6720 SW Macadam Ave.
Suite 200
Portland, OR 97219

Phone (503) 419-2500
Fax (503) 419-2600

www.cardno.com

Attendees:

Matt Lewis – Project Engineer	Cardno	Matt.Lewis@cardno.com
Debbie Pearson – Senior Program Manager	Day CPM	dpearson@daycpm.com
Charles Benson – Planner	City of Tualatin	CBenson@tualatin.gov
Dean Pickett	Tualatin LaCrosse	dean@coeproperties.com
Junior Carbasal	Neighbor	Jrcarbasal06@gmail.com
Charles W. Glaeser	Neighbor	twoglaesers@gmail.com
Rich Anderson		randerson1972@yahoo.com
Joel Augee	Neighbor	joelaugee2005@yahoo.com
Julie Cooper		juldujour@hotmail.com
Erik VanKleer	Neighbor	referees@tualatinsoccer.com
Les Boatsman	Neighbor	Lboatsman23@gmail.com
Mark Dervedde		mdervedde@me.com
Jill Zurschmeide	Neighbor	
Holly Stuart	Neighbor	Hollyfarm05@gmail.com
Jake Austin	Baseball Coach	jaustin@ttsd.k12.or.us
Michael Dellerba	Associate Principal	mdellerba@ttsd.k12.or.us
Darin Barnard	Principal	dbarnard@ttsd.k12.or.us
Ted Rose	Athletic Director	trose@ttsd.k12.or.us
Bill Wilson	Softball Coach	billwilson@live.com
Jim Stuart	Neighbor/Students	stu3113@gmail.com



Meeting Minutes (Recorded by Matt Lewis):

1. Matt welcomed the community members and reiterated that this is the 3rd of 3 athletic facility stakeholder meetings. This also serves as the official neighborhood meeting in anticipation of a separate Architectural Review application specific to the athletic facilities.
2. Matt provided a brief overview of the Architectural Review process through the City of Tualatin, including neighborhood meeting, application submittal, completeness review, public notice, staff review, staff report, and public appeal.
3. Based on information gathered from previous meetings:
 - a. To reduce neighbor impact, focus field improvements away from campus perimeter and towards the central track.
 - b. A preference not to impact the existing higher quality natural grass fields east of baseball.
 - c. Preference to preserve softball and baseball varsity fields at present location
 - d. Desire to separate proposed multi-use synthetic field from proposed varsity softball and baseball synthetic fields.
 - e. Improve drainage of preserved natural grass fields
 - f.
4. Matt presented an exhibit, attached, that locates amenities based on the previous stakeholder meetings, design team modifications, and TTSD input. Pricing is not included on this exhibit.
5. Debbie noted the budget for these facilities was originally costed at \$2.8 million. The bond program does take into account some escalation, which leaves the athletic budget at approximately \$3 million.
6. Questions from the community were fielded, including:
 - a. Is there an opportunity to widen multi-field?
 - i. Response: Yes, the dimensions illustrated on based on a compromise between preferred geometry and cost considerations. Additional input from the athletic department will be considered with design progression.
 - b. Is storage still provided in batting cage facility?
 - i. Response: Storage is preferred in the facility, but it will depend on refined contractor costing.
 - c. Does this fall in budget?
 - i. Response: The design team is working with contractors to refine pricing.
 - d. Is lighting included with this rendition?
 - i. Response: No. There may be a provision to include conduits for future lighting, but lights are not included in this proposal. Any future lighting will require additional land use process including public notice and meetings.
 - e. A neutral paint for batting cages is preferred.
 - f. Are grants available to help finance improvements?
 - i. Response: Yes, any additional funding source is welcomed. The project design could allow for phasing and future development pending additional funds.
 - g. How is the cost of this project impacted if softball/baseball synthetic turf fields were eliminated?
 - i. Response: Cost would be approximately half.



- h. How will parking be affected?
 - i. Response: There is no impact to parking with this proposal. Internal campus pedestrian circulation will be improved with ADA access paths to baseball and softball.
 - i. Please look at options of fencing in the multi-use field. There have been issues with staph in the past.

- 7. Debbie thanked everyone for attending and indicated that the design team would take additional comments into consideration with design progression. The next step for TTSD is to submit a land use application.

Meeting Adjourned at 7:45 PM

The above represents a summary of the writer's understanding of the items discussed and conclusions reached.

Preliminary Drainage Report

Tualatin High School Improvements

21612290



Prepared for
Tigard-Tualatin School District
6960 SW Sandburg Street
Tigard, Oregon
97223

December 18, 2017



EXPIRATION DATE: 6/30/18

Document Information

Prepared for Tigard-Tualatin School District
Project Name Tualatin High School Improvements
File Reference 1229-Preliminary Drainage Report.docx
Job Reference 21612290
Date December 18, 2017

Contact Information

Cardno

6720 SW Macadam Ave. Suite 200
Portland, Oregon
97219

Telephone: 503-419-2500
Facsimile: 503-419-2600

Matt.Lewis@cardno.com
www.cardno.com

Document Control

Version	Date	Author	Author Initials	Reviewer	Reviewer Initials
1	October 17, 2017	Daniel Child	DEC	Cedomir Jestic	CJ
2	December 18, 2017	Daniel Child	DEC	Cedomir Jestic	CJ

© Cardno 2017. Copyright in the whole and every part of this document belongs to Cardno and may not be used, sold, transferred, copied or reproduced in whole or in part in any manner or form or in or on any media to any person other than by agreement with Cardno.

This document is produced by Cardno solely for the benefit and use by the client in accordance with the terms of the engagement. Cardno does not and shall not assume any responsibility or liability whatsoever to any third party arising out of any use or reliance by any third party on the content of this document.

EXECUTIVE SUMMARY

The City of Tualatin is proposing site improvements at Tualatin High School located at 22101 22300 SW Boones Ferry Road (See Figure 1 – Vicinity Map). The site is approximately 65 acres and spans from SW Ibach Ct to SW Palouse Ln going from north to south along SW Boones Ferry Rd.

The purpose of this report is to describe the water quality facilities being proposed as part of the Tualatin High School improvement and to show that the design follows the standards and regulations for the City of Tualatin. The total impact area for this development is approximately 23 acres. The water quality and quantity designs follow the Clean Water Services *Design and Construction Standards for Sanitary Sewer and Surface Water Management*, issued April 2017.

The proposed storm improvements include collecting and conveying stormwater runoff from the proposed building additions, path and plaza improvements, fire access routes, and artificial turf fields. The collected stormwater will be detained to Clean Water Services requirements through the combination of a regraded extended dry pond located along SW Boones Ferry Road, and in drain rock beneath the proposed artificial turf fields. Water quality treatment requirements will be fulfilled through the combination of the regraded extended dry pond along SW Boones Ferry Road, Contech StormFilter water quality manholes, and a Contech StormFilter catch basin. The proposed system will release into the existing public storm sewer system located in SW Boones Ferry Road.

Table of Contents

EXECUTIVE SUMMARY	iii
1 VICINITY MAP	6
2 PROJECT DESCRIPTION	7
2.1 Project Overview	7
3 PRE-DEVELOPED CONDITIONS	7
3.1 Topography	7
3.2 Climate	7
3.3 Site Geology	7
3.4 Hydrology	7
3.5 Curve Number	8
3.6 Time of Concentration	8
3.7 Existing Basin Areas	8
4 POST-DEVELOPED CONDITIONS	8
4.1 Hydrology	8
4.2 Curve Number	8
4.3 Time of Concentration	9
4.4 Basin Areas	9
5 HYDROLOGIC ANALYSIS DESIGN GUIDELINES	9
5.1 Design Guidelines	9
5.2 Hydrograph Method	10
5.3 Design Storm	10
6 WATER QUALITY	11
6.1 Water Quality Guidelines	11
6.2 Water Quality Facilities	11
7 WATER QUANTITY	12
7.1 Water Quantity Guidelines	12
7.2 Water Quantity Analysis	12
7.3 Release Rates	12
7.4 Control Structure	13
7.5 Detention Volume	14
8 SUMMARY	14

Tables

Table 3-1	Soil Characteristics	7
Table 3-2	Time of Concentration	8
Table 3-3	Existing Basin Areas	8
Table 4-1	Post-Developed Basin Areas	9
Table 5-1	Precipitation Depth	10
Table 6-1	Extended Dry Pond Information	11
Table 6-2	Contech StormFilter Manhole Information	11
Table 6-3	Contech StormFilter Catch Basin Information	11
Table 7-1	Allowable Release Rates	12
Table 7-2	Release Rates	13
Table 7-3	Control Structure Summary	13
Table 7-4	Facility Detention Volume	14

Figures

Figure 1-1	Vicinity Map	6
Figure 5-1	25-Year Clean Water Services Type 1A Rainfall Distribution	10

1 VICINITY MAP

Figure 1-1 Vicinity Map

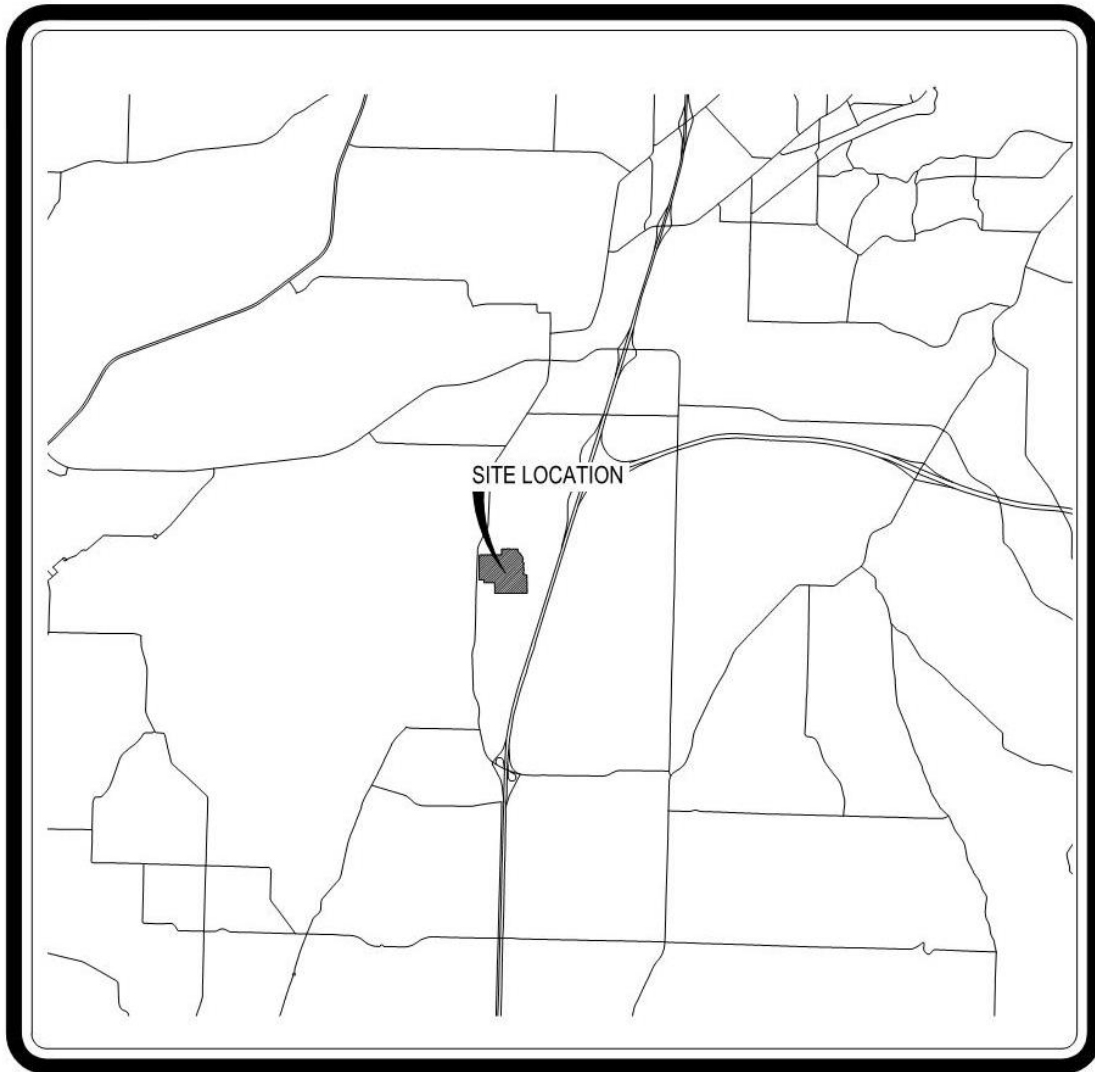

VICINITY MAP
SCALE: NTS



2 PROJECT DESCRIPTION

2.1 Project Overview

The City of Tualatin is proposing site improvements at Tualatin High School located at 22101 22300 SW Boones Ferry Rd (See Figure 1 – Vicinity Map). The total site is approximately 65 acres and spans from SW Ibach Ct to SW Palouse Ln going from north to south along SW Boones Ferry Rd.

The purpose of this report is to describe the water quality/quantity facilities being proposed as part of the Tualatin High School improvements and to show that the design follows the standards and regulations for the City of Tualatin. The water quality designs follow the Clean Water Services Design and Construction Standards, issued April 2017.

3 PRE-DEVELOPED CONDITIONS

3.1 Topography

The existing site contains the existing school development constructed in 1991. The site includes three main school buildings, sports facilities, concessions, concrete, gravel and asphalt pathways and off-street parking. The highest elevation of 346 is located in the southeast corner of the site. The lowest elevation of 280 is located at the northeast corner of the site. Site slopes are predominately 1-2% from southeast to northwest with terraced sections separating the mildly sloped areas.

Pre-developed conditions are assumed to be farmland with a continuous 2% downward slope from the southeast to the northwest of the property.

3.2 Climate

The site is located in Washington County approximately 60 miles inland from the Pacific Ocean. There is a gradual change in seasons with defined seasonal characteristics. Average daily temperatures range from 34°F to 80°F. Record temperatures recorded for this region of the state are -18°F and 108°F. Average annual rainfall recorded in this area is 42 inches. Average annual snowfall is approximately 2 inches between December and March.

3.3 Site Geology

The underlying soil types on the site, as classified by the United States Department of Agriculture Soil Survey of Washington County, Oregon are identified in Table 3-1 (See Technical Appendix: Hydrologic Soil Group - Washington County).

Table 3-1 Soil Characteristics

Soil Type	Hydrologic Group
Cornelius Silt Loam	C
Kinton Silt Loam	C

3.4 Hydrology

In existing conditions, stormwater is collected by roof drains or catch basins and is conveyed to existing stormwater quality facilities located throughout the site. These facilities provide water quality treatment and detention before discharging into the public storm sewer located in SW Boones Ferry Road.

3.5 Curve Number

The curve number (CN) represents runoff potential from the soil. The major factors for determining the CN values are hydrologic soil group, cover type, treatment, hydrologic condition and antecedent runoff condition. The selected pervious curve number is 74 – Open Spaces – Good condition. (See Technical Appendix: Table 2-2a – Runoff Curve Numbers for Urban Areas).

3.6 Time of Concentration

The time of concentration (T_c) as described in NEH-4 Chapter 15 is defined in two ways; the time for runoff to travel from the furthestmost point of the watershed to the point in question, and the time from the end of excess rainfall to the point of inflection on the trailing limb of the unit hydrograph. Time of concentration can be estimated from several formulas. Clean Water Services guidelines which are based on the NRCS method were used in this analysis.

The minimum time of concentration is 5 minutes in highly developed urban areas (i.e. parking lots) and the maximum is 100 minutes in rural areas. Because the existing site has been heavily graded, the pre-developed topography has been assumed as homogenous across the site with an average slope of 2% and a length of flow of 900 feet based on the impacted area. These assumptions are reflected in the pre-developed time of concentration calculation which is listed in Table 3-2 (See Technical Appendix: Time of Concentration Calculation).

Table 3-2 Time of Concentration

Basin	Time of Concentration, minutes
Pre-Developed	15

3.7 Existing Basin Areas

The proposed Tualatin High School Improvements project will impact approximately 12.6 acres. The existing site consists of the Tualatin High School complex with associated buildings, parking area, landscaping, and athletic fields. All stormwater in the impacted area discharges to the public storm sewer in SW Boones Ferry Road in existing conditions. Table 3-3 shows the existing conditions of the proposed impacted area.

Table 3-3 Existing Basin Areas

Basin	Pervious Area, acres	Impervious Area, acres	Percent Impervious	Total Area, acres
Existing	14.792	7.987	35.1%	22.779

4 POST-DEVELOPED CONDITIONS

4.1 Hydrology

Stormwater from the impacted area will be collected, conveyed, and discharged to the regraded stormwater facility which will then discharge to the public storm sewer in SW Boones Ferry Road. Stormwater from the impacted area will be conveyed to the proposed regraded stormwater detention pond with the exception of stormwater intercepted by the proposed turf field at the southern end of the property. Stormwater from the turf field will be detained and treated separately from the rest of the impacted area.

4.2 Curve Number

The selected pervious curve number is 74 – Open space, good condition (See Technical Appendix: Table 2-2a – Runoff Curve Numbers for Urban Areas).

4.3 Time of Concentration

The minimum time of concentration recommended by Clean Water Services is 5 minutes in highly developed urban areas (i.e. parking lots) and the maximum is 100 minutes in rural areas. Three components are considered for determining the Tc: sheet flow, shallow concentrated flow, and channel / pipe flow. Due to the highly impervious nature of the impacted site, the minimum Tc of 5 minutes was used.

4.4 Basin Areas

Impacted area for the site was delineated according to outfall destination. These basins include area tributary to the impacted stormwater facility along SW Boone's Ferry Road, and the proposed turf field which will be detained and treated separately from the remainder of the site. Table 4-1 outlines the post-developed basin areas (See Technical Appendix: Exhibit 1 – Post-Developed Basin Delineation).

Table 4-1 Post-Developed Basin Areas

Basin ID	Post-Developed Basin Areas			Total acres
	Pervious acres	Impervious acres	Percent Impervious	
SW Boones Ferry Road Detention Pond				
A1	0.055	0.751	93.2%	0.806
A2	0.411	0.818	66.6%	1.229
A3	0.028	0.171	85.9%	0.199
A4	2.287	6.881	75.1%	9.168
A5	0.032	1.295	84.1%	1.539
Subtotal	2.813	9.916	76.6%	12.941
South Turf Field				
B1	0.000	5.628	100.0%	5.628
Subtotal	0.000	5.628	100.0%	5.628
East Turf Fields				
B4	0.796	2.735	77.4%	3.531
Subtotal	0.796	2.735	77.4%	3.531
Undetained				
B2	0.228	0.097	29.8%	0.325
B3	0.235	0.118	33.5%	0.353
Total	4.071	18.495	81.2%	22.779

5 HYDROLOGIC ANALYSIS DESIGN GUIDELINES

5.1 Design Guidelines

The site is located within the city of Tualatin which follows stormwater standards set by Clean Water Services. The analysis and design criteria used for stormwater management described in this section will follow the Clean Water Services *Design and Construction Standards for Sanitary Sewer and Surface Water Management*, issued April 2017.

5.2 Hydrograph Method

Naturally occurring rainstorms dissipate over long periods of time. The most effective way of estimating storm rainfall is by using the hydrograph method. The NRCS Curve Number method is described in the *NRCS National Engineering Handbook* - Section 4. The NRCS runoff method equation is:

$$Q = \frac{(P - I_a)^2}{(P - I_a) + S}$$

Where:

Q = Runoff (cfs) P = Rainfall (inches)
S = Potential maximum retention after runoff begins I_a = Initial abstraction

During the development of a runoff hydrograph, the above equation is used to compute the incremental runoff depth for each time step from the incremental runoff depth given by the design storm hydrograph.

5.3 Design Storm

The rainfall distribution to be used within the Clean Water Services jurisdiction is the design storm of 24-hour duration based on the standard Type 1A rainfall distribution. Table 5-1 shows total precipitation depths for different storm events. The CWS Design Storm Distribution for a type 1A 24-hour rainfall distribution for a 25-year storm event is shown in Figure 5-1.

Table 5-1 Precipitation Depth

Recurrence interval (years)	Total Precipitation Depth (in)
2	2.50
10	3.50
25	4.00
100	4.50

Figure 5-1 25-Year Clean Water Services Type 1A Rainfall Distribution

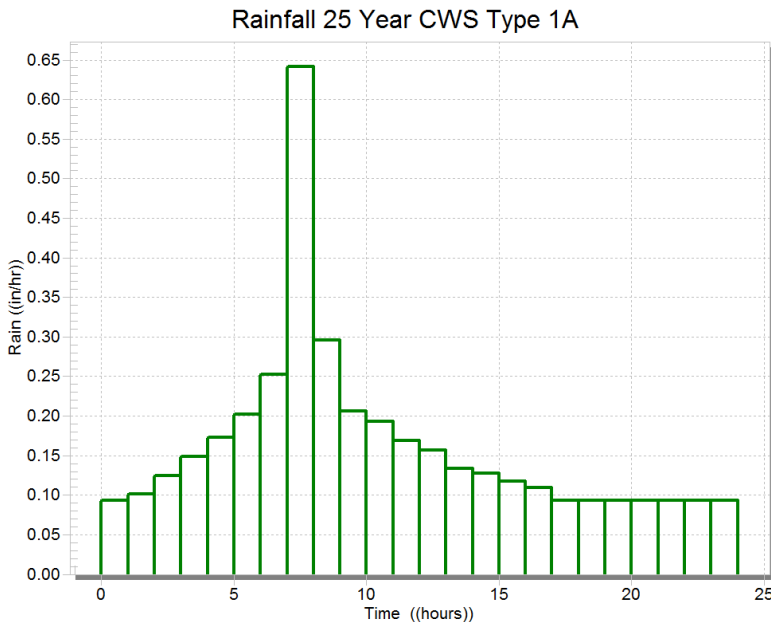

6 WATER QUALITY

6.1 Water Quality Guidelines

The proposed water quality facilities were designed per Clean Water Services standards. The sizing of each facility is determined based on the impervious area flowing into the facility. Sizing

6.2 Water Quality Facilities

Per Section 4.05.5 of the Clean Water Services design manual all created impervious area will be treated. Per Section 4.05.6 of the Clean Water Services design manual, the water quality volume and flow rate are calculated according to the equations below:

$$\text{Water Quality Volume (cf)} = \frac{0.36 \text{ (in)} \times \text{Area (sf)}}{12 \text{ (in/ft)}} \quad \text{Water Quality Flow} = \frac{\text{WQV (cf)}}{14,400}$$

These water quality calculations are based on 0.36 inches of rainfall during a dry weather, 4-hour duration storm.

Water quality will be provided within an extended dry pond, Contech StormFilter catch basins, and Contech StormFilter manholes. Table 6-1 outlines the water quality design for the SW Boones Ferry Road extended dry pond.

Table 6-1 Extended Dry Pond Information

Facility	Impervious Area, sq-ft	Required WQ Volume, cu-ft	Minimum Required WQ Depth, ft	Total Depth, ft
Boones Ferry Road Dry Pond	431,955	12,959	1.69	4.00

Because runoff from the proposed turf fields will be detained prior to water quality treatment, a 4-hour storm totaling 0.36 inches of total runoff was used to calculate water quality flows. Table 6-2 outlines the water quality design for the proposed Contech StormFilter water quality manholes.

Table 6-2 Contech StormFilter Manhole Information

Facility	Impervious Area, sq-ft	CWS WQ Flow, cfs	Calculated WQ flow, cfs	StormFilter Cartridge Treatment Rate, gpm	Required Number of Cartridges
South Field 72" StormFilter Manhole	245,158	0.511	0.149	22.5	3
East Field 72" StormFilter Manhole	119,135	0.248	0.068	22.5	2

For the proposed ADA ramp access to the proposed east turf fields, and the fire access on the east side of the existing auditorium, an existing inlet will be retrofitted with a Contech StormFilter catch basin. Table 6-3 outlines the water quality design for the proposed filter catch basin.

Table 6-3 Contech StormFilter Catch Basin Information

Facility	Impervious Area, sq-ft	CWS WQ Flow, cfs	StormFilter Cartridge Treatment Rate, gpm	Required Number of Cartridges
StormFilter Catch Basin	9,380	0.020	15	1

All remaining area will be treated by existing onsite facilities.

7 WATER QUANTITY

The stormwater detention facilities was designed to detain runoff generated from the 2 through 25-year storm event. Detention will be accomplished through either the proposed regraded extended dry pond, or in drain rock beneath the proposed artificial turf field.

7.1 Water Quantity Guidelines

The Tualatin High School site is located in the Hedges Creek Subbasin as defined by the Tualatin Drainage Plan which the city of Tualatin requires that all stormwater discharged from sites within this subbasin be detained such that the developed flow rates for the 2-year, 10-year, and 25-year 24-hour storms meet the pre-developed flow rates of the corresponding 2-year, 10-year, and 25-year storms.

7.2 Water Quantity Analysis

The initial sizing of the proposed water quantity facility used the runoff generated in the xpswmm runoff module for the SBUH for the 2-year, 10-year, and 25-year storm events. All runoff was routed through the proposed water quantity facilities in the hydraulic module of xpswmm.

7.3 Release Rates

The allowable release rates for the site are based on the pre-developed site generated release rates. The allowable release rates for the site are shown in Table 7-1.

Table 7-1 Allowable Release Rates

Storm Event	Pre-Developed Rate, cfs
SW Boones Ferry Dry Pond	
2-year	0.954
10-year	2.840
25-year	3.885
South Turf Field	
2-year	0.515
10-year	1.493
25-year	2.034
East Turf Fields and Undetained Area	
2-year	0.355
10-year	1.031
25-year	1.404

The design release rates for the site are shown in Table 7-2, and were generated by routing the post-developed runoff rates through the proposed detention facilities in xpswmm. The generated releases rates are at or less than those allowed by the City of Tualatin (See Technical Appendix: Pre-Developed Hydrographs, and Post-Developed Hydrographs).

Table 7-2 Release Rates

Storm Event	Pre-Developed Rate, cfs
SW Boones Ferry Dry Pond	
2-year	0.946
10-year	2.705
25-year	3.855
South Turf Field	
2-year	0.317
10-year	0.791
25-year	1.095
East Turf Fields	
2-year	0.148
10-year	0.370
25-year	0.487
Undetained Area	
2-year	0.202
10-year	0.398
25-year	0.502

The east turf fields are overdetained to account for the undetained flow from basins B2 and B3 which include the proposed ADA ramp access to the east turf fields and the proposed fire access on the east side of the existing auditorium.

7.4 Control Structure

The proposed control structures are 60-inch manholes with a 24-inch standpipes. In all cases the bottom orifices were designed to control the 2-year release rate. The turf fields will control storm events up to and including the 25-year storm with the orifice and stand pipe overflow, while the pond will control these flows with a notch weir together with the orifice.

Table 7-3 Control Structure Summary

	Stage, ft	Diameter/Width, in
Boones Ferry Dry Pond		
Orifice	0.00	1.60
Notch Weir	2.25	28.50
Stand Pipe	3.00	75.40
South Turf Field		
Orifice	0.00	5.50
Stand Pipe	0.17	75.40
East Turf Fields		
Orifice	0.00	2.875
Stand Pipe	0.17	75.40

7.5 Detention Volume

The resulting calculated detention volumes are shown in Table 7-4.

Table 7-4 Facility Detention Volume

Facility	Required Detention Volume, cu-ft	Available Detention Volume, cu-ft
Boones Ferry Road Dry Pond	34,650	54,374
South Turf Field	16,671	49,032
East Turf Field	23,441	70,322

The detention facilities will have at least one foot of freeboard during the 25-year storm event and will completely contain storms up to and including the 100-year storm. Additional, details on the detention system will be provided in the final drainage report.

8 SUMMARY

The proposed storm management approach follows the *Design and Construction Standards for Sanitary Sewer and Surface Water Management* issued by Clean Water Services April 2017.

Water quality for Tualatin High School will be provided by a combination of existing stormwater facilities, the proposed regraded Boones Ferry Road dry pond, the proposed 72 inch diameter Contech StormFilter manholes, and the proposed Contech StormFilter catch basin. Water quantity requirements will be accomplished through existing facilities, the proposed regraded Boones Ferry Road dry pond, and drain rock beneath the proposed turf fields.

In conclusion, the proposed storm water management system will meet the requirements of the City of Tualatin and Clean Water Services.

Tualatin High School Improvements

TECHNICAL APPENDIX

Technical Appendix

- > Exhibit 1 – Post-Developed Basin Delineation
- > Time of Concentration
- > Hydrologic Soil Group – Washington County
- > Table 2-2a – Runoff Curve Numbers for Urban Areas
- > Pre-Developed Hydrographs
- > Post-Developed Hydrographs

References

1. *Design and Construction Standards for Sanitary Sewer and Surface Water Management.* issued April 2017 – Clean Water Services
2. *Technical Release 55 – Urban Hydrology of Small Watersheds.* U.S. Department of Agriculture, NRCS

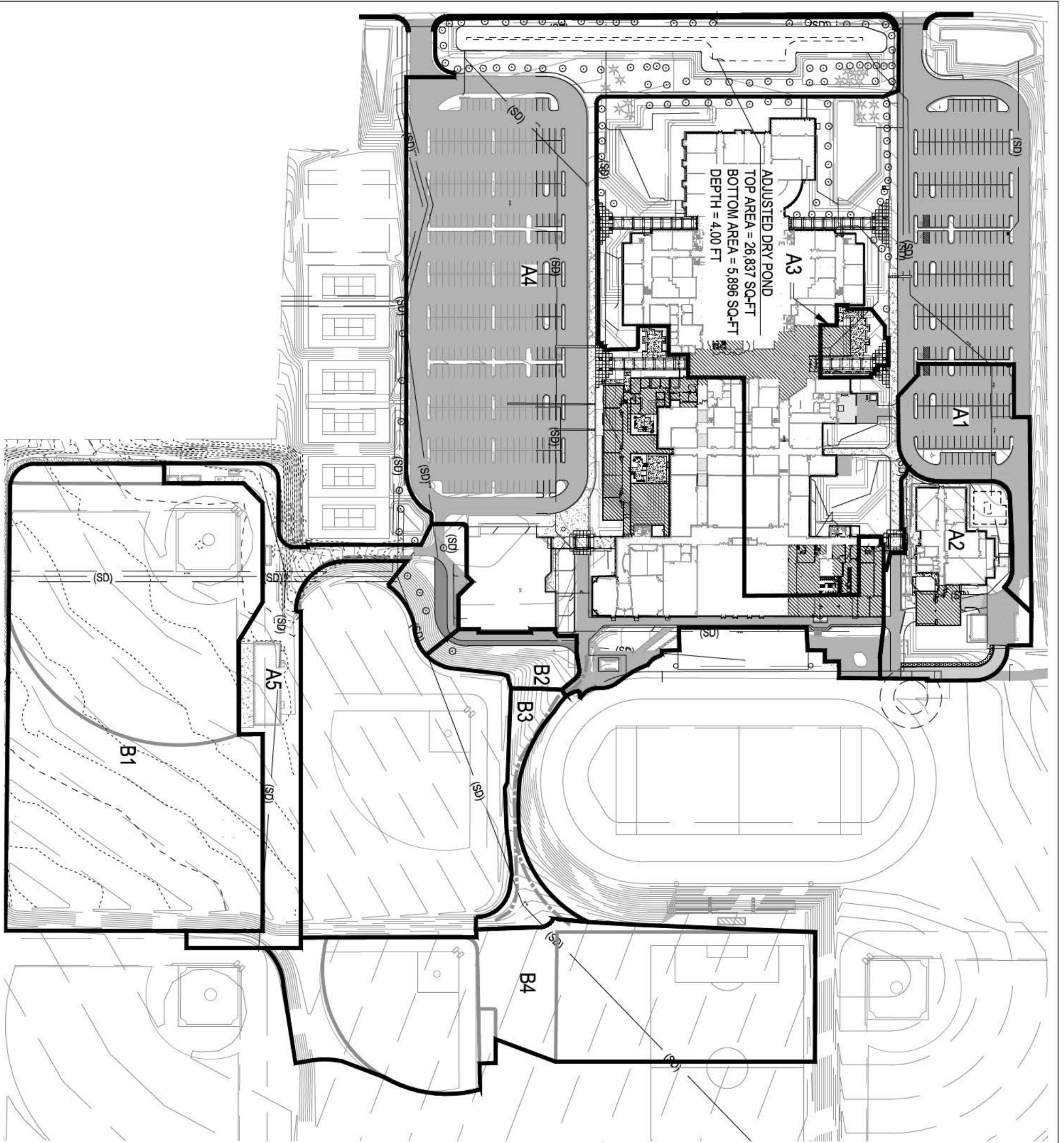

Post-Developed Basin Areas				
Basin ID	Pervious <i>acres</i>	Impervious <i>acres</i>	Percent Impervious	Total <i>acres</i>
A1	0.055	0.751	93.2%	0.806
A2	0.411	0.818	66.6%	1.229
A3	0.028	0.171	85.9%	0.199
A4	2.287	6.881	75.1%	9.168
A5	0.032	1.295	84.1%	1.539
B1	0.000	5.628	100.0%	5.628
B2	0.228	0.097	29.8%	0.325
B3	0.235	0.118	33.5%	0.353
B4	0.796	2.735	77.4%	3.531
Total	4.071	18.495	81.2%	22.779

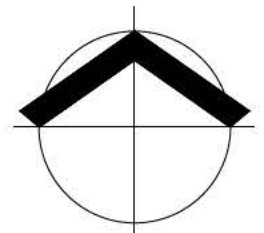

SCALE: 1"=150'

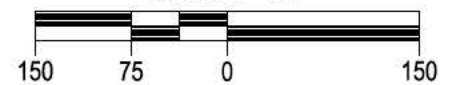

PROJECT NO. 21612290
 DATE: 12/18/2017
 BY: DEC
 EXHIBIT: 1

**PROPOSED BASIN DELINEATION
 TUALATIN HIGH SCHOOL IMPROVEMENTS**

Tigard-Tualatin School District
 Tualatin, Oregon

Cardno
 Shaping the Future
 PORTLAND
 6720 SW MACADAM AVE, STE 200, PORTLAND, OR 97219
 TEL: (503) 419-2500 FAX: (503) 419-2600
 www.cardno.com



Time of Concentration

PROJECT NO.	21612290	BY	DEC	DATE	10/17/2017
-------------	----------	----	-----	------	------------

To Detention			
SHEET FLOW			
INPUT	Pre-Developed	VALUE	VALUE
Surface Description	Type 2 Fallow (no residue)	Type	Type
Manning's "n"	0.05		
Flow Length, L (<300 ft)	300 ft	ft	ft
2-Yr 24 Hour Rainfall, P ₂	2.5 in	in	in
Land Slope, s	0.02 ft/ft	ft/ft	ft/ft
OUTPUT			
Travel Time	0.18 hr	hr	hr
SHALLOW CONCENTRATED FLOW			
INPUT	Pre-Developed		
Surface Description	Unpaved		
Flow Length, L	600 ft	ft	ft
Watercourse Slope*, s	0.020 ft/ft	ft/ft	ft/ft
OUTPUT			
Average Velocity, V	2.28 ft/s	ft/s	ft/s
Travel Time	0.073 hr	hr	hr
CHANNEL FLOW			
INPUT	Pre-Developed		
Cross Sectional Flow Area, a	0 ft ²	ft ²	ft ²
Wetted Perimeter, P _w	0 ft	ft	ft
Channel Slope, s	0 ft/ft	ft/ft	ft/ft
Manning's "n"	0.24		
Flow Length, L	0 ft	ft	ft
OUTPUT			
Average Velocity	0.00 ft/s	ft/s	ft/s
Hydraulic Radius, r = a / P _w	0.00 ft	ft	ft
Travel Time	0.00 hr	hr	hr
Watershed or Subarea T _c =	0.26 hr	hr	hr
Watershed or Subarea T _c =	15 minutes	minutes	minutes

Hydrologic Soil Group—Washington County, Oregon
(Tualatin High School Improvements)

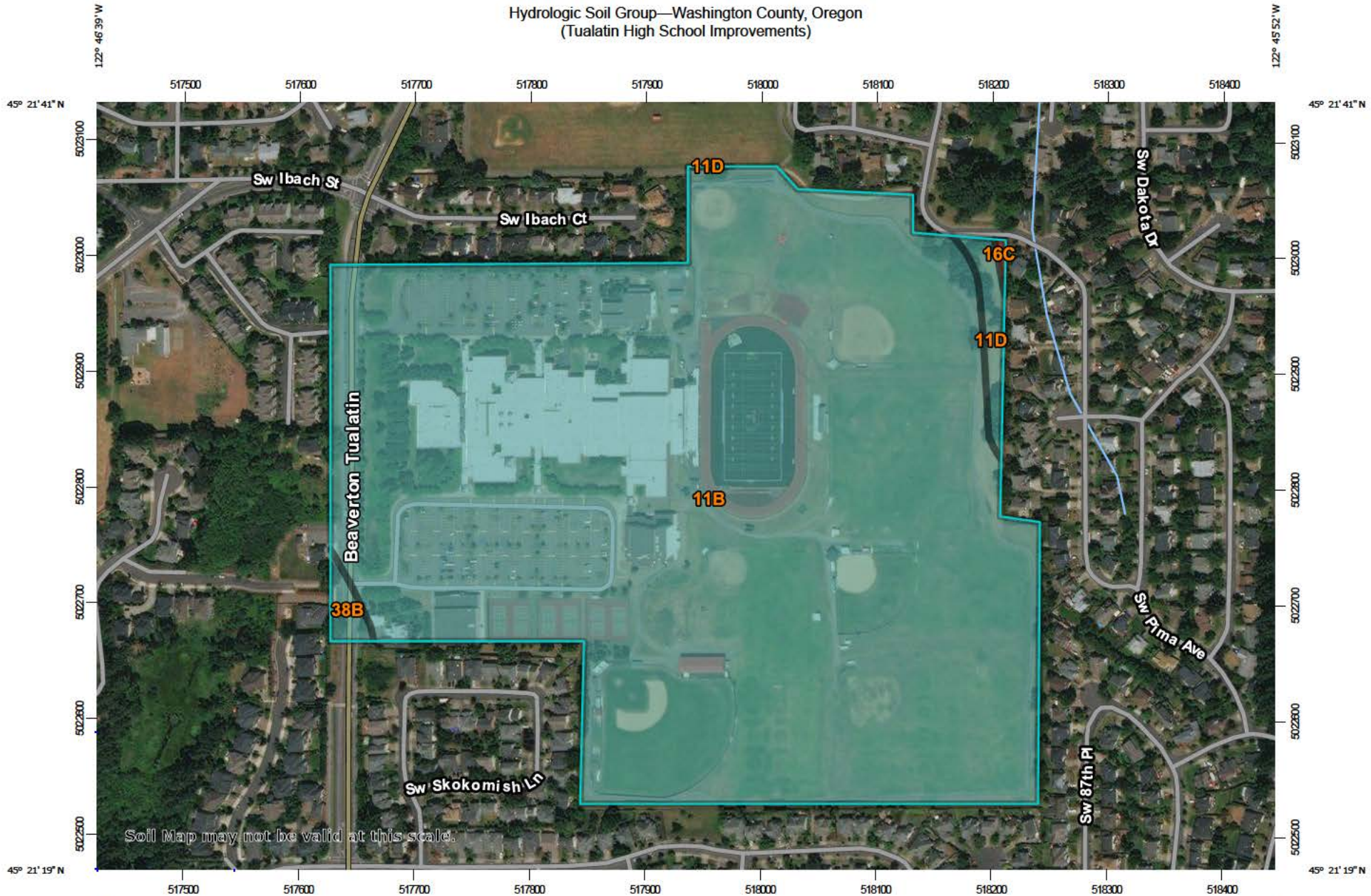

Soil Map may not be valid at this scale.

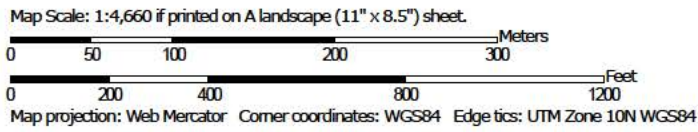

Hydrologic Soil Group—Washington County, Oregon
(Tualatin High School Improvements)









MAP LEGEND

Area of Interest (AOI)









 Area of Interest (AOI)

Soils

Soil Rating Polygons





-  A
-  A/D
-  B
-  B/D
-  C
-  C/D
-  D
-  Not rated or not available

Soil Rating Lines

-  A
-  A/D
-  B
-  B/D
-  C
-  C/D
-  D
-  Not rated or not available

Soil Rating Points

-  A
-  A/D
-  B
-  B/D

-  C
-  C/D
-  D
-  Not rated or not available

Water Features

 Streams and Canals

Transportation

-  Rails
-  Interstate Highways
-  US Routes
-  Major Roads
-  Local Roads

Background

 Aerial Photography

MAP INFORMATION

The soil surveys that comprise your AOI were mapped at 1:20,000.

Warning: Soil Map may not be valid at this scale.

Enlargement of maps beyond the scale of mapping can cause misunderstanding of the detail of mapping and accuracy of soil line placement. The maps do not show the small areas of contrasting soils that could have been shown at a more detailed scale.

Please rely on the bar scale on each map sheet for map measurements.

Source of Map: Natural Resources Conservation Service
Web Soil Survey URL:
Coordinate System: Web Mercator (EPSG:3857)

Maps from the Web Soil Survey are based on the Web Mercator projection, which preserves direction and shape but distorts distance and area. A projection that preserves area, such as the Albers equal-area conic projection, should be used if more accurate calculations of distance or area are required.

This product is generated from the USDA-NRCS certified data as of the version date(s) listed below.

Soil Survey Area: Washington County, Oregon
Survey Area Data: Version 15, Sep 19, 2017

Soil map units are labeled (as space allows) for map scales 1:50,000 or larger.

Date(s) aerial images were photographed: Aug 19, 2015—Sep 13, 2016

The orthophoto or other base map on which the soil lines were compiled and digitized probably differs from the background imagery displayed on these maps. As a result, some minor shifting of map unit boundaries may be evident.

Hydrologic Soil Group

Map unit symbol	Map unit name	Rating	Acres in AOI	Percent of AOI
11B	Cornelius and Kinton silt loams, 2 to 7 percent slopes	C	64.4	98.0%
11D	Cornelius and Kinton silt loams, 12 to 20 percent slopes	C	0.8	1.3%
16C	Delena silt loam, 3 to 12 percent slopes	D	0.1	0.1%
38B	Saum silt loam, 2 to 7 percent slopes	C	0.4	0.6%
Totals for Area of Interest			65.7	100.0%

Description

Hydrologic soil groups are based on estimates of runoff potential. Soils are assigned to one of four groups according to the rate of water infiltration when the soils are not protected by vegetation, are thoroughly wet, and receive precipitation from long-duration storms.

The soils in the United States are assigned to four groups (A, B, C, and D) and three dual classes (A/D, B/D, and C/D). The groups are defined as follows:

Group A. Soils having a high infiltration rate (low runoff potential) when thoroughly wet. These consist mainly of deep, well drained to excessively drained sands or gravelly sands. These soils have a high rate of water transmission.

Group B. Soils having a moderate infiltration rate when thoroughly wet. These consist chiefly of moderately deep or deep, moderately well drained or well drained soils that have moderately fine texture to moderately coarse texture. These soils have a moderate rate of water transmission.

Group C. Soils having a slow infiltration rate when thoroughly wet. These consist chiefly of soils having a layer that impedes the downward movement of water or soils of moderately fine texture or fine texture. These soils have a slow rate of water transmission.

Group D. Soils having a very slow infiltration rate (high runoff potential) when thoroughly wet. These consist chiefly of clays that have a high shrink-swell potential, soils that have a high water table, soils that have a claypan or clay layer at or near the surface, and soils that are shallow over nearly impervious material. These soils have a very slow rate of water transmission.

If a soil is assigned to a dual hydrologic group (A/D, B/D, or C/D), the first letter is for drained areas and the second is for undrained areas. Only the soils that in their natural condition are in group D are assigned to dual classes.

Rating Options

Aggregation Method: Dominant Condition

Component Percent Cutoff: None Specified

Tie-break Rule: Higher

Table 2-2a Runoff curve numbers for urban areas ^{1/}

Cover description	Average percent impervious area ^{2/}	Curve numbers for hydrologic soil group			
		A	B	C	D
Fully developed urban areas (vegetation established)					
Open space (lawns, parks, golf courses, cemeteries, etc.) ^{3/} :					
Poor condition (grass cover < 50%)		68	79	86	89
Fair condition (grass cover 50% to 75%)		49	69	79	84
Good condition (grass cover > 75%)		39	61	74	80
Impervious areas:					
Paved parking lots, roofs, driveways, etc. (excluding right-of-way)		98	98	98	98
Streets and roads:					
Paved; curbs and storm sewers (excluding right-of-way)		98	98	98	98
Paved; open ditches (including right-of-way)		83	89	92	93
Gravel (including right-of-way)		76	85	89	91
Dirt (including right-of-way)		72	82	87	89
Western desert urban areas:					
Natural desert landscaping (pervious areas only) ^{4/}		63	77	85	88
Artificial desert landscaping (impervious weed barrier, desert shrub with 1- to 2-inch sand or gravel mulch and basin borders)		96	96	96	96
Urban districts:					
Commercial and business	85	89	92	94	95
Industrial	72	81	88	91	93
Residential districts by average lot size:					
1/8 acre or less (town houses)	65	77	85	90	92
1/4 acre	38	61	75	83	87
1/3 acre	30	57	72	81	86
1/2 acre	25	54	70	80	85
1 acre	20	51	68	79	84
2 acres	12	46	65	77	82

Developing urban areas

Newly graded areas
(pervious areas only, no vegetation) ^{5/}

	77	86	91	94
--	----	----	----	----

Idle lands (CN's are determined using cover types
similar to those in table 2-2c).

¹ Average runoff condition, and $I_a = 0.2S$.

² The average percent impervious area shown was used to develop the composite CN's. Other assumptions are as follows: impervious areas are directly connected to the drainage system, impervious areas have a CN of 98, and pervious areas are considered equivalent to open space in good hydrologic condition. CN's for other combinations of conditions may be computed using figure 2-3 or 2-4.

³ CN's shown are equivalent to those of pasture. Composite CN's may be computed for other combinations of open space cover type.

⁴ Composite CN's for natural desert landscaping should be computed using figures 2-3 or 2-4 based on the impervious area percentage (CN = 98) and the pervious area CN. The pervious area CN's are assumed equivalent to desert shrub in poor hydrologic condition.

⁵ Composite CN's to use for the design of temporary measures during grading and construction should be computed using figure 2-3 or 2-4 based on the degree of development (impervious area percentage) and the CN's for the newly graded pervious areas.

Tualatin High School Improvements — Pre-Developed Hydrographs



Boones Ferry Dry Pond
Pre-Developed Hydrograph

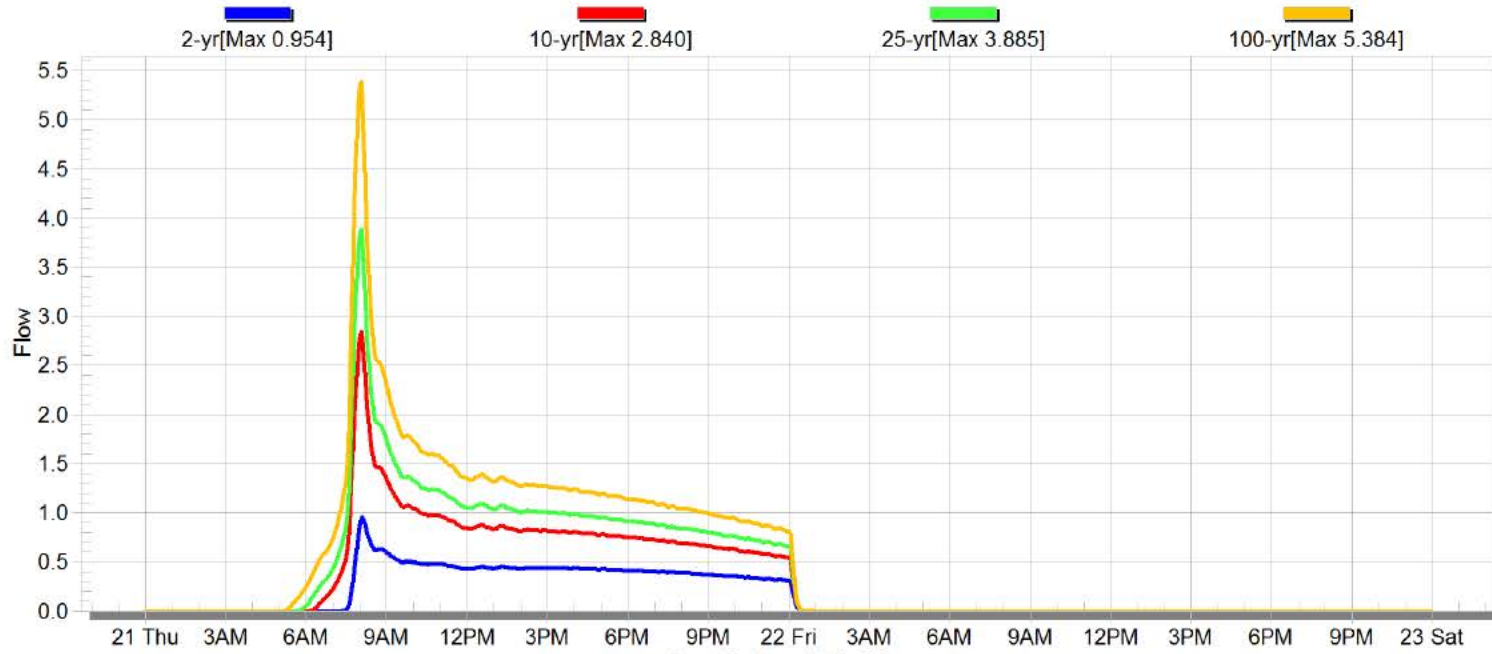

South Turf Field
Pre-Developed Hydrograph

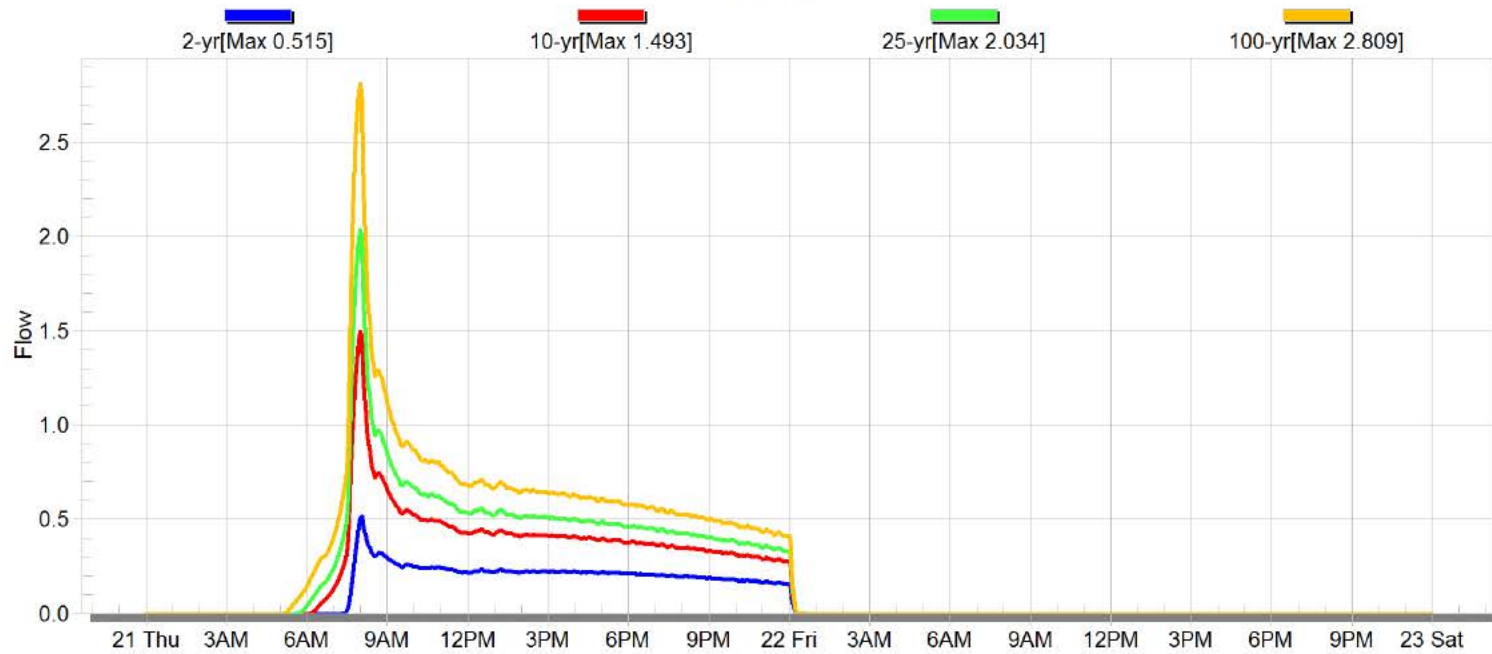

Tualatin High School Improvements — Pre-Developed Hydrographs



East Turf Field and Undetained Area Pre-Developed Hydrograph

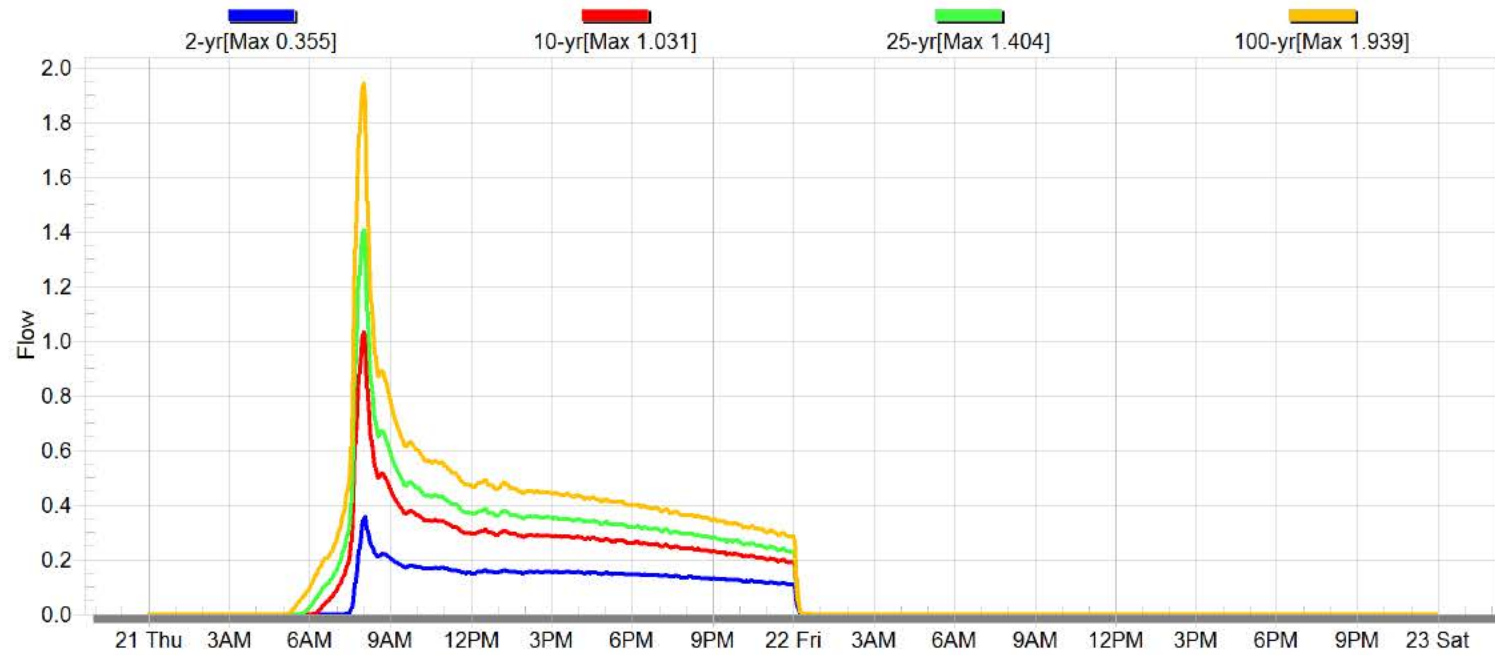

Boones Ferry Dry Pond

Post-Developed Hydrograph

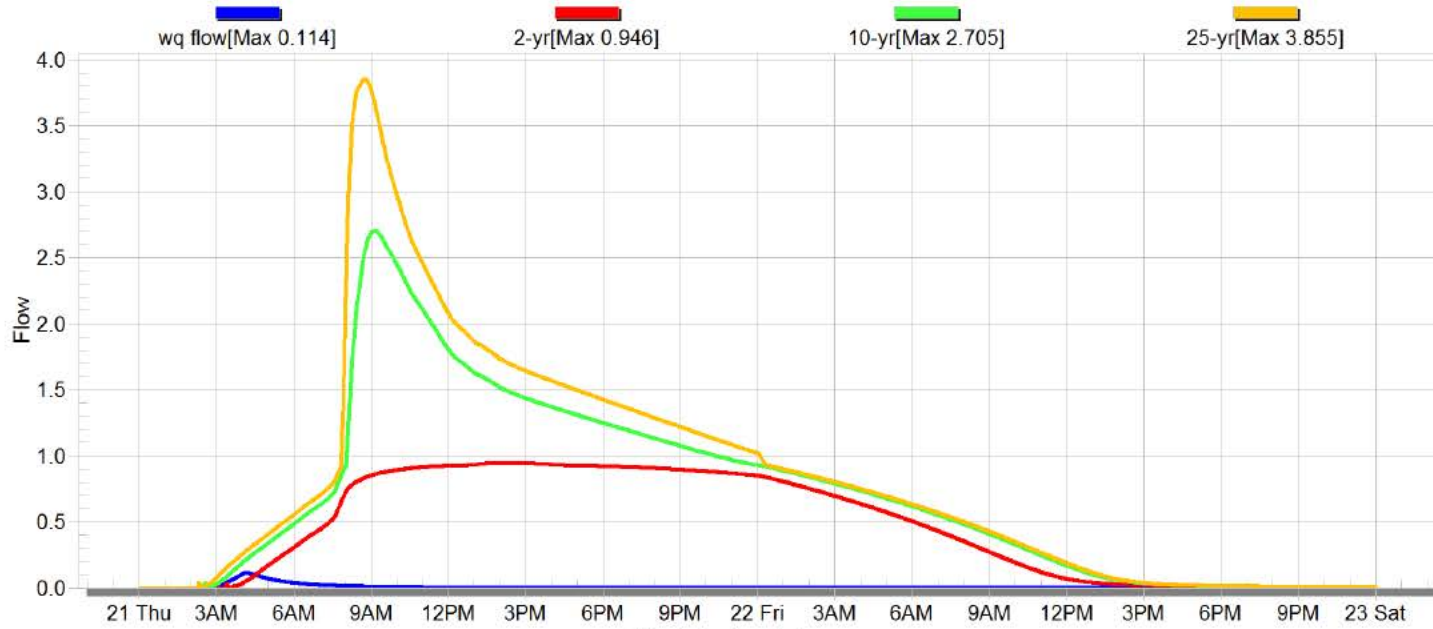

Undetained Area

Post-Developed Hydrograph

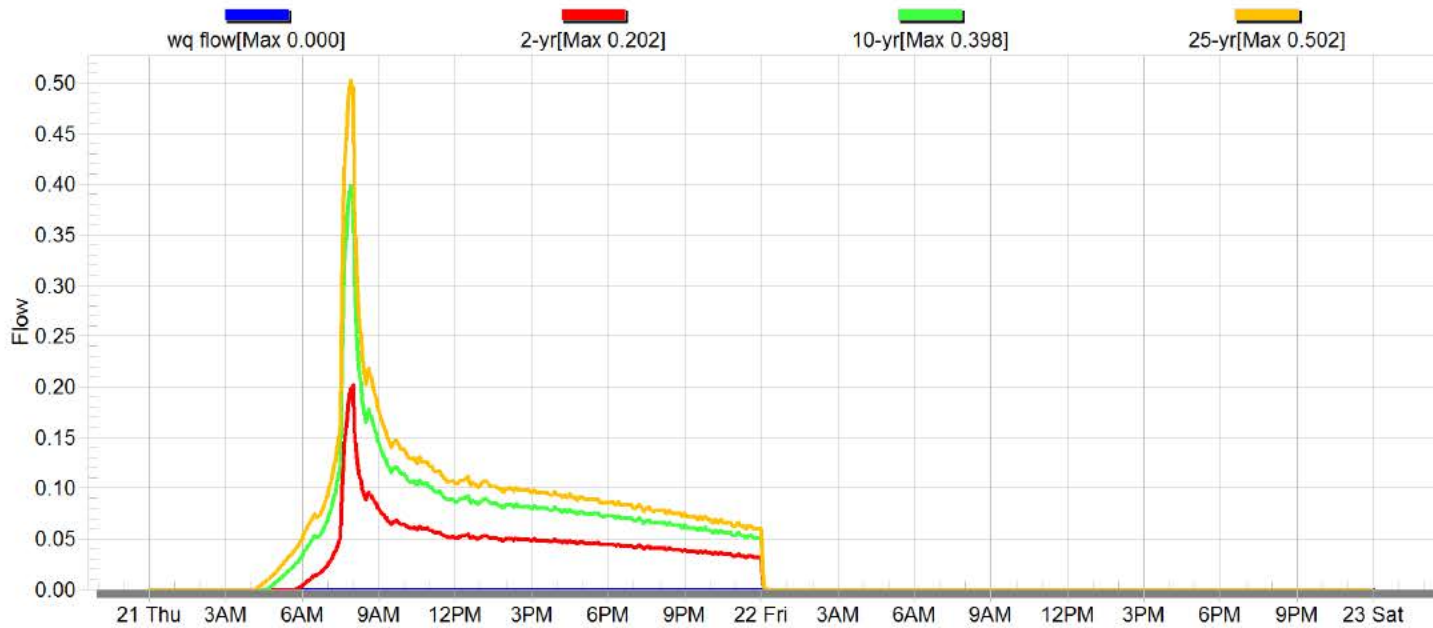

Tualatin High School Improvements — Post-Developed Hydrographs



South Turf Field Post-Developed Hydrograph

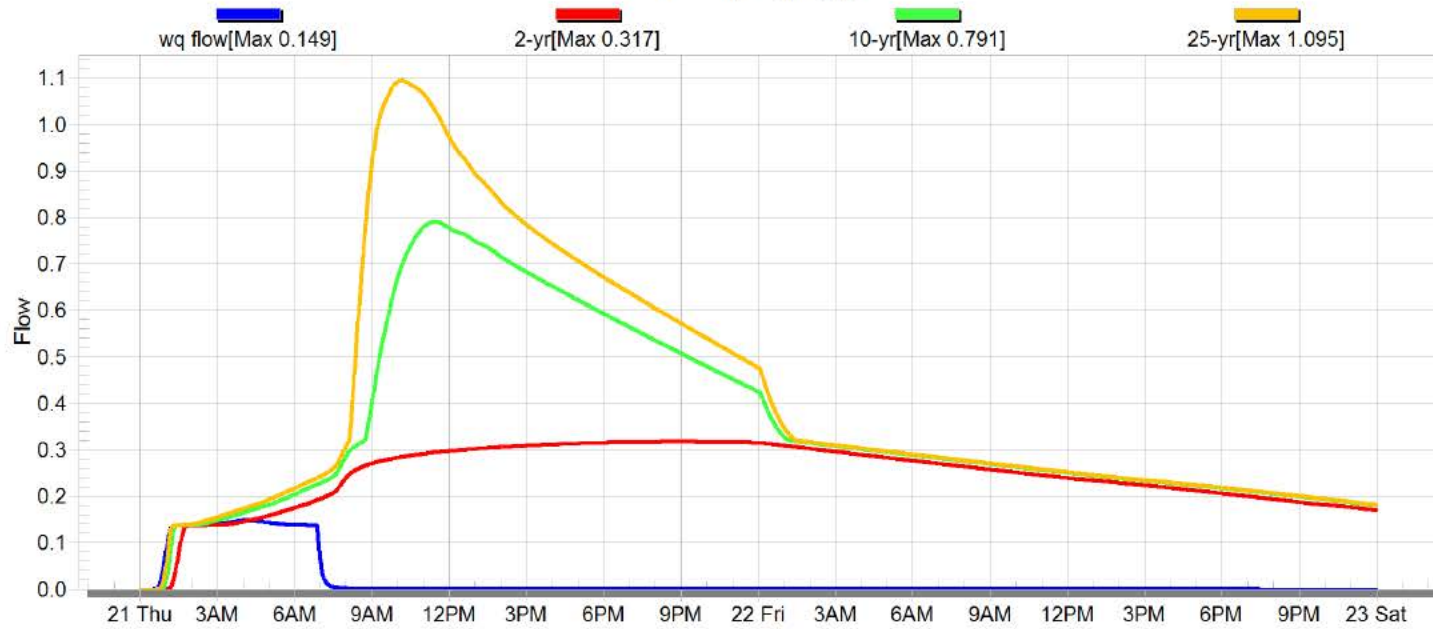

East Turf Field Post-Developed Hydrograph

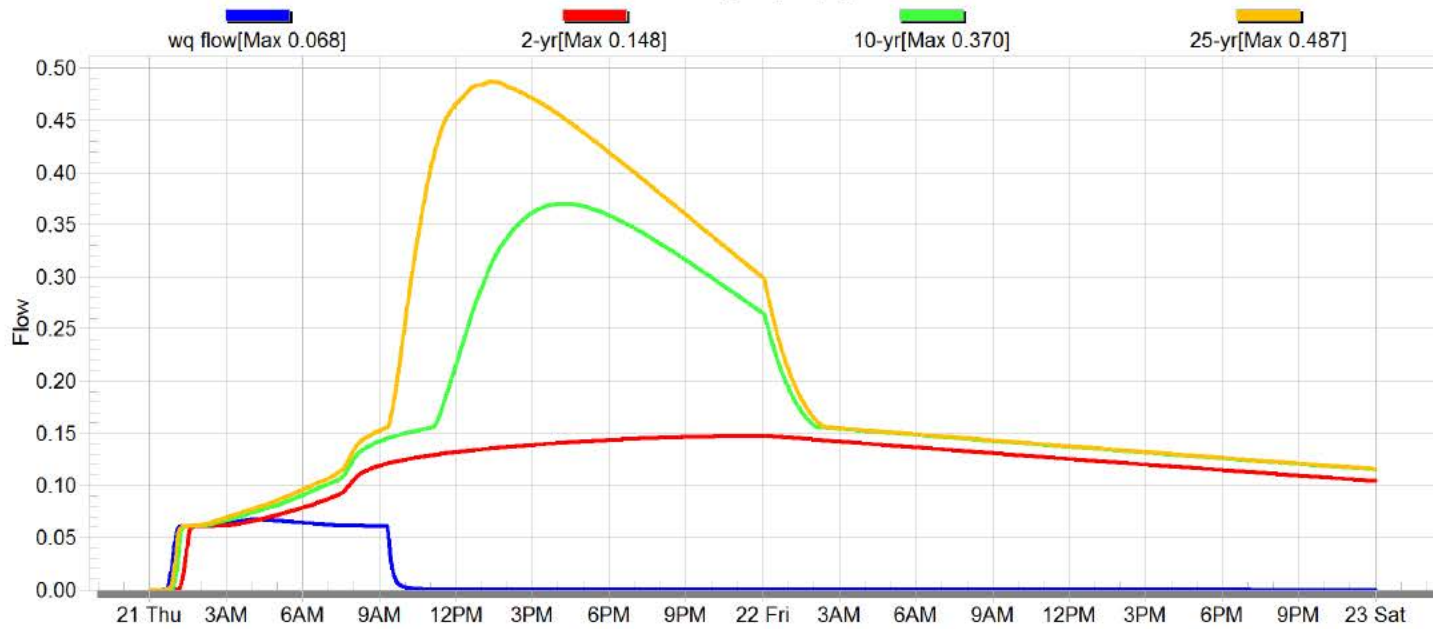



9750 SW Nimbus Avenue
Beaverton, OR 97008-7172
p | 503-641-3478 f | 503-644-8034

August 4, 2017

5970-E GEOTECHNICAL RPT

Tigard-Tualatin School District
6960 SW Sandburg Street
Tigard, OR 97223

DRAFT

Attention: Debbie Pearson/DAY CPM Services, LLC

**SUBJECT: Geotechnical Investigation and Site-Specific Seismic-Hazard Evaluation
Tualatin High School
Tualatin, Oregon**

As requested, GRI completed a geotechnical investigation for the planned improvements at Tualatin High School in Tualatin, Oregon. The Vicinity Map, Figure 1, shows the general location of the site. The purpose of the investigation was to evaluate subsurface conditions at the site and develop geotechnical recommendations for use in the design and construction of the proposed improvements. The investigation included a review of existing geotechnical information for the site and surrounding area, subsurface explorations, laboratory testing, and engineering analyses. As part of our investigation, GRI completed a site-specific seismic-hazard evaluation to satisfy the requirements of the 2012 International Building Code (IBC), which was adopted by the 2014 Oregon Structural Specialty Code (OSSC). This report describes the work accomplished and provides conclusions and recommendations for use in the design and construction of the proposed project.

PROJECT DESCRIPTION

We understand Tualatin High School will receive new building additions and remodeling work under the 2016 Tualatin-Tigard School District Bond Program. Based on our review of conceptual plans, we understand the new additions will consist of technical education classrooms, locker and training rooms, a commons area, an administration and lobby area, additional classrooms, and a fitness area. The Site Map, Figure 2, shows the approximate locations of the new building additions with respect to the existing school and associated buildings. We anticipate the new additions will consist of single-story, at-grade structures. Although structural loads for the new building additions are not currently available, we anticipate the column and wall loads will be on the order of 100 kips and 3 kips/ft, respectively. We anticipate the finished floor elevation for the new building additions will be consistent with the existing school, and cuts and fills to establish grade for the additions will be minimal.

SITE DESCRIPTION

General

The project site is developed with the existing school building, which will be expanded and portions remodeled for this project. The existing school building is bordered by parking lots on the north and south, a football field and track on the east, and SW Boones Ferry Road on the west. Review of satellite imagery and our observations at the site indicate the ground surface gently slopes downward from east to west across the site.

Geology

Published geologic mapping indicates the site is mantled with residual soils produced from the weathering of the underlying Columbia River Basalt (O'Connor et. al, 2001). These residual soils typically consist of brown to red-brown silt and clay soils of relatively high plasticity that exhibit relict structures of the weathered rock. The weathering profile of the basalt grades from residual soil to hard rock with increasing depth within a given flow. The hard basalt is generally highly to moderately fractured and moderately weathered. It is not uncommon to have this weathering sequence repeated; the interflow zones commonly exhibit soil-like characteristics and frequently transmit groundwater.

SUBSURFACE CONDITIONS

General

Subsurface materials and conditions at the site were investigated between June 2 and June 14, 2017, with three borings, designated B-1 through B-3; one cone penetrometer test (CPT) sounding, designated CPT-1; and two dilatometer (DMT) soundings, designated DMT-1 and DMT-2. The borings were advanced to depths of about 30.2 to 35.1 ft, the CPT probe to a depth of about 11.3 ft, and the DMT soundings to depths of about 4.6 to 10 ft below existing site grades. The approximate locations of the explorations completed for this investigation are shown on Figure 2. Logs of the borings, CPT probe, and DMT soundings are provided on Figures 1A through 7A. The field and laboratory programs conducted to evaluate the physical engineering properties of the materials encountered in the explorations are described in Appendix A. The terms and symbols used to describe the materials encountered in the explorations are defined in Tables 1A through 4A and the attached legend.

Sampling

Disturbed and undisturbed soil samples were obtained from the borings at 2.5-ft intervals of depth in the upper 15 ft and 5-ft intervals below 15 ft. Disturbed soil samples were obtained using a 2-in.-outside-diameter (O.D.) standard split-spoon (SPT) sampler. Penetration tests were conducted by driving the samplers into the soil a distance of 18 in. using a 140-lb hammer dropped 30 in. The number of blows required to drive the SPT sampler the last 12 in. is known as the Standard Penetration Resistance, or SPT N-value. SPT N-values provide a measure of the relative density of granular soils and the relative consistency of cohesive soils. Relatively undisturbed soil samples were collected by pushing a 3-in.-O.D. Shelby tube into the undisturbed soil a maximum of 24 in. using the hydraulic ram of the drill rig. The soil in the Shelby tubes was extruded in our laboratory and Torvane shear strength measurements were recorded on selected samples. In addition, rock-core samples of basalt were obtained from boring B-2 below a depth of 25 ft.

Soils

For the purpose of discussion, the materials disclosed by our investigation have been grouped into the following categories based on their physical characteristics and engineering properties:

1. PAVEMENT
2. FILL
3. Clayey SILT to Silty CLAY (Residual Soil)
4. Sandy SILT to Silty SAND (Decomposed Basalt)
5. BASALT (Columbia River Basalt)

The following paragraphs provide a detailed description of the materials encountered in the explorations and a discussion of the groundwater conditions at the site.

1. PAVEMENT. All of the explorations were advanced in existing paved areas and encountered approximately 3 in. of asphalt concrete (AC) pavement at the ground surface. The pavement is underlain by about 9 in. of crushed-rock base (CRB) course.

2. FILL. Silty clay fill was encountered beneath the pavement section in explorations B-1 and CPT-1 and extends to depths of about 5 to 6 ft. The silty clay fill is brown and dark gray and contains a trace of fine-grained sand. The relative consistency of the silty clay fill is soft to very stiff based on an SPT N-value of 17 blows/ft and CPT tip resistance values of about 10 to 28 tsf; however, CPT tip resistance values of about 67 to 75 tsf were recorded beneath the pavement section in exploration CPT-1. The natural moisture content of the silty clay fill is about 20%.

3. Clayey SILT to Silty CLAY (Residual Soil). Residual soil consisting of clayey silt to silty clay was encountered beneath the pavement section in explorations B-2, DMT-1, and DMT-2. The residual soil is derived from the weathering of the underlying Columbia River Basalt and extends to depths of about 5 to 12.5 ft. The soil is typically brown to red-brown and contains a variable amount of fine- to coarse-grained sand ranging from a trace to some sand. The relative consistency of the soil is medium stiff to hard based on SPT N-values of 8 to 19 blows/ft, Torvane shear strength values of 0.35 to 0.60 tsf, and DMT constrained modulus values of about 500 to 1,500 tsf. The natural moisture content of the soil ranges from 27 to 36%. Atterberg limit test results indicate the soil has a liquid limit of 63% and a plasticity index of 36%, see Figure 8A. Exploration DMT-1 was terminated in residual soil at a depth of about 4.6 ft.

4. Sandy SILT to Silty SAND (Decomposed Basalt). Decomposed basalt in the form of sandy silt to silty sand was encountered beneath the pavement section in exploration B-3, beneath fill in explorations B-1 and CPT-1, and beneath residual soil in exploration DMT-2. The thickness of the decomposed basalt unit is variable, ranging from 2 to 5 ft thick, and extends to depths of about 5 to 11.3 ft. The soil is gray mottled brown to gray-brown and generally consists of fine- to coarse-grained sand with a variable amount of clay ranging from trace to some clay. Relict rock structure is present within the unit. Our drilling for the project and our experience in the site vicinity indicate this deposit usually contains gravel- to boulder-size fragments of predominantly decomposed basalt.

The relative consistency of the sandy silt is stiff based on an N-value of 9 blows/ft. The relative density of the silty sand is very loose to very dense based on an SPT N-value of 4 blows/ft, CPT tip resistance values of about 450 to 565 tsf, and DMT constrained modulus values of about 815 to 1,150 tsf. The natural moisture content of the soil ranges from 48 to 53%. Explorations CPT-1 and DMT-2 were terminated in decomposed basalt at depths of about 10 to 11.3 ft.

5. BASALT (Columbia River Basalt). Extremely soft (R0) to medium-hard (R3) basalt of the Columbia River Basalt Group was encountered beneath clayey silt to silty clay (residual soil) in exploration B-2 and beneath sandy silt to silty sand (decomposed basalt) in explorations B-1 and B-3. The basalt was encountered at depths of 5 to 12.5 ft and extends to the maximum depth explored of 35.1 ft. In boring B-2, the basalt was cored below a depth of 25 ft. The quality of basalt, as measured by the degree of hardness and weathering, was highly variable. Core recovery ranged from 61 to 67%. The basalt has some vesicles and close joints and fractures inclined at 45°, resulting in typical rock quality designations (RQD) of 0 to 7%. The joints and fractures displayed some staining and secondary mineralization was observed on some joint and fracture faces and in some vesicles. Typically, the basalt is gray-brown and predominantly decomposed to decomposed near the top of the unit and grades to gray and moderately weathered with depth. Explorations B-1 through B-3 were terminated in basalt at depths of 30.2 to 35.1 ft.

Groundwater

The borings were completed using mud-rotary drilling techniques, which do not allow an accurate measurement of the groundwater level during drilling. Our review of U.S. Geological Survey (USGS) groundwater data suggests the regional groundwater level at the site typically occurs at depth in the highly fractured, hard basalt that underlies the site. However, our experience in the project vicinity indicates perched groundwater can occur in the fill soil, residual soil, and decomposed basalt that mantle the site, particularly following periods of intense or prolonged precipitation.

CONCLUSIONS AND RECOMMENDATIONS

General

Subsurface explorations completed for this investigation indicate the site is mantled with localized areas of silty clay fill underlain by residual soil and/or decomposed basalt produced by the weathering of the underlying Columbia River Basalt. Groundwater was not encountered at the time of exploration; however, we anticipate perched groundwater may approach the ground surface at the site during the wet winter months or following intense or prolonged precipitation.

In our opinion, foundation support for new structural loads can be provided by conventional spread and wall foundations established in firm, undisturbed, native soil or compacted structural fill. The primary geotechnical considerations associated with construction of the proposed building additions and associated improvements include the presence of fine-grained soils at the ground surface that are extremely sensitive to moisture content; the potential for shallow, perched groundwater conditions; and the presence of shallow basalt. The following sections of this report provide our conclusions and recommendations for use in the design and construction of the project.

Seismic Considerations

General. We understand the project will be designed in accordance with the 2012 IBC with 2014 OSSC modifications. For seismic design, the 2012 IBC references the American Society of Civil Engineers (ASCE) document 7-10 titled “Minimum Design Loads for Buildings and Other Structures” (ASCE 7-10). A site-specific seismic-hazard evaluation was completed for the project in accordance with the 2014 OSSC. Details of the site-specific seismic-hazard evaluation and the development of the recommended response spectra are provided in Appendix B.

Code Background. The 2012 IBC and ASCE 7-10 seismic hazard levels are based on a Risk-Targeted Maximum Considered Earthquake (MCE_R) with the intent of including the probability of structural collapse. The ground motions associated with the probabilistic MCE_R represent a targeted risk level of 1% in 50 years probability of collapse in the direction of maximum horizontal response with 5% damping. In general, these risk-targeted ground motions are developed by applying adjustment factors of directivity and risk coefficients to the 2% probability of exceedance in 50 years, or 2,475-year return period, hazard level (MCE) ground motions developed from the 2014 USGS Unified Hazard Tool (USGS, 2014). The risk-targeted probabilistic values are also subject to a deterministic limit. The code-based, ground-surface, MCE_R -level spectrum is typically developed using the mapped bedrock spectral accelerations, S_s and S_1 , and corresponding site coefficients, F_a and F_v , to account for site soil conditions.

Site Response. The maximum horizontal-direction spectral response accelerations were obtained from the USGS Seismic Design Maps for the coordinates of 45.3590° N latitude and 122.7726° W longitude. The S_s and S_1 parameters identified for the site are 0.94 and 0.41 g, respectively, for Site Class B, or bedrock conditions. To establish the ground-surface MCE_R spectrum, these bedrock spectral coefficients are adjusted for site class using the short- and long-period site coefficients, F_a and F_v , in accordance with Section 11.4.3 of ASCE 7-10. The design-level response spectrum is calculated as two-thirds of the ground-surface MCE_R spectrum.

In accordance with Section 20.4.2 of ASCE 7-10, the site is classified as Site Class C, or a very dense soil and soft rock site, based on an estimated V_{s30} of about 2,000 ft/sec in the upper 100 ft of the soil profile. Based on the subsurface conditions disclosed by the explorations and the results of our site-specific seismic hazard evaluation, the soil profile at the site is representative of Site Class C conditions. The recommended MCE_R - and design-level spectral response parameters for Site Class C conditions are tabulated below and discussed in further detail in Appendix B.

RECOMMENDED SEISMIC DESIGN PARAMETERS (2012 IBC/2014 OSSC)

Seismic Parameter	Recommended Value
Site Class	C
MCE _R 0.2-Sec Period Spectral Response Acceleration, S_{MS}	0.96 g
MCE _R 1.0-Sec Period Spectral Response Acceleration, S_{M1}	0.57 g
Design-Level 0.2-Sec Period Spectral Response Acceleration, S_{DS}	0.64 g
Design-Level 1.0-Sec Period Spectral Response Acceleration, S_{D1}	0.38 g

Seismic Hazards. Based on the depth to groundwater at the site, it is our opinion the risk of liquefaction and/or cyclic softening at the site is low. Based on site topography, the risk of earthquake-induced slope instability is low. The risk of damage by tsunami and/or seiche at the site is absent. The inferred location of the Canby-Mollala Fault is about 5 km east of the site (Personius et al., 2003); however, the USGS does not consider the Canby-Mollala Fault to be an active, contributing source in their Probabilistic Seismic Hazard Analysis (PSHA). The USGS considers the Bolton Fault, located about 9 km east of the site, to be

the closest crustal fault source contributing to the overall seismic hazard at the site. Unless occurring on a previously unmapped or unknown fault, the risk of fault rupture at the site is low.

Earthwork

General. The fine-grained soils that mantle the site are sensitive to moisture, and perched groundwater may approach the ground surface during the wet winter months. Therefore, it is our opinion earthwork can be completed most economically during the dry summer months, typically extending from June to mid-October. It has been our experience that the moisture content of the upper few feet of silty soils will decrease during extended warm, dry weather. However, below this depth, the moisture content of the soil tends to remain relatively unchanged and well above the optimum moisture content for compaction. As a result, the contractor must use construction equipment and procedures that prevent disturbance and softening of the subgrade soils. To minimize disturbance of the moisture-sensitive silt and clay soils, site grading can be completed using track-mounted hydraulic excavators. The excavation should be finished using a smooth-edge bucket to produce a firm, undisturbed surface. It may also be necessary to construct granular haul roads and work pads concurrently with excavation to minimize subgrade disturbance. If the subgrade is disturbed during construction, soft, disturbed soils should be overexcavated to firm soil and backfilled with structural fill.

If construction occurs during wet ground conditions, granular work pads will be required to protect the underlying fine-grained subgrade and provide a firm working surface for construction activities. In our opinion, a 12- to 18-in.-thick granular work pad should be sufficient to prevent disturbance of the subgrade by lighter construction equipment and limited traffic by dump trucks. Haul roads and other high-density traffic areas will require a minimum of 18 to 24 in. of fragmental rock, up to 6-in. nominal size, to reduce the risk of subgrade deterioration. The use of a geotextile fabric over the subgrade may reduce maintenance during construction.

As an alternative to the use of a thickened section of crushed rock to support construction activities and protect the subgrade, the subgrade soils can be treated with cement. It has been our experience in this area that treating the subgrade soils to a depth of 12 to 14 in. with about a 6 to 8% admixture of cement overlain by 6 to 12 in. of crushed rock will support construction equipment and provide a good, all-weather working surface.

Site Preparation. Demolition of existing improvements within the limits of the proposed improvements should include removal of existing pavements, floor slabs, foundations, walls, and underground utilities (if present). The ground surface within all building areas, paved areas, walkways, and areas to receive structural fill should be stripped of existing vegetation, surface organics, and loose surface soils. We anticipate stripping up to a depth of about 4 to 6 in. will likely be required within vegetated areas; however, deeper grubbing may be required to remove brush and tree roots. All demolition debris, trees, brush, and surficial organic material should be removed from within the limits of the proposed improvements. Excavations required to remove existing improvements, brush, and trees should be backfilled with structural fill. Organic strippings should be disposed of off site or stockpiled on site for use in landscaped areas.

Following stripping or excavation to subgrade level, the exposed subgrade should be evaluated by a qualified member of GRI's geotechnical engineering staff or an engineering geologist. Proof rolling with a

loaded dump truck may be part of this evaluation. Any soft areas or areas of unsuitable material disclosed by the evaluation should be overexcavated to firm material and backfilled with structural fill. Due to the presence of localized fill soils and previous development at the site, it should be anticipated some overexcavation of subgrade will be required.

Rock Excavation. We anticipate shallow basalt may be encountered in excavations completed to found the new building additions and/or in utility excavations. The hardness, jointing, and weathering of the underlying basalt will be highly variable depending on location and depth. While it may be possible to excavate zones of highly fractured or weathered basalt by ripping with a large bulldozer and/or a large track-mounted hydraulic excavator equipped with a rock bucket and rock teeth, it should be anticipated that some rock chipping, splitting, or blasting will be necessary to remove harder zones of less-weathered and fractured rock, if encountered. However, blasting may not be permitted due to the close proximity of existing buildings or other site improvements. Project plans, specifications, and bid items should address the uncertainty associated with encountering basalt in excavations completed on site.

Structural Fill. We anticipate minor amounts of structural fill will be placed for this project. We recommend structural fill consist of granular material, such as sand, sandy gravel, or crushed rock with a maximum size of 2 in. Granular material that has less than 5% passing the No. 200 sieve (washed analysis) can usually be placed during periods of wet weather. Granular backfill should be placed in lifts and compacted with vibratory equipment to at least 95% of the maximum dry density determined in accordance with ASTM D698. Appropriate lift thicknesses will depend on the type of compaction equipment used. For example, if hand-operated vibratory-plate equipment is used, lift thicknesses should be limited to 6 to 8 in. If smooth-drum vibratory rollers are used, lift thicknesses up to 12 in. are appropriate, and if backhoe- or excavator-mounted vibratory plates are used, lift thicknesses of up to 2 ft may be acceptable.

On-site, fine-grained soils and site strippings free of debris may be used as fill in landscaped areas. These materials should be placed at about 90% of the maximum dry density as determined by ASTM D698. The moisture contents of soils placed in landscaped areas are not as critical as the moisture contents of fill placed in building and pavement areas, provided construction equipment can effectively handle the materials.

Utility Excavations. In our opinion, there are three major considerations associated with design and construction of new utilities.

- 1) Provide stable excavation side slopes or support for trench sidewalls to minimize loss of ground.
- 2) Provide a safe working environment during construction.
- 3) Minimize post-construction settlement of the utility and ground surface.

The method of excavation and design of trench support are the responsibility of the contractor and subject to applicable local, state, and federal safety regulations, including the current Occupational Safety and Health Administration (OSHA) excavation and trench safety standards. The means, methods, and sequencing of construction operations and site safety are also the responsibility of the contractor. The

information provided below is for the use of our client and should not be interpreted to mean we are assuming responsibility for the contractor's actions or site safety.

According to current OSHA regulations, the majority of the fine-grained soils encountered in the explorations may be classified as Type B. In our opinion, trenches less than 4 ft deep that do not encounter groundwater may be cut vertically and left unsupported during the normal construction sequence, assuming trenches are excavated and backfilled in the shortest possible sequence. Excavations more than 4 ft deep should be laterally supported or alternatively provided with side slopes of 1H:1V (Horizontal to Vertical) or flatter. In our opinion, adequate lateral support may be provided by common methods, such as the use of a trench shield or hydraulic shoring systems. Also, it should be anticipated that basalt may be encountered in utility excavations, and large excavation equipment or excavation methods, such as chipping, splitting, chemical rock breaking, or blasting, may be required. More detailed information about rock excavation methods and techniques is provided in the **Rock Excavation** subsection of this report.

We anticipate perched groundwater may approach the ground surface during intense or prolonged precipitation. Groundwater seepage, running soil conditions, and unstable trench sidewalls or soft trench subgrades, if encountered during construction, will require dewatering of the excavation and trench sidewall support. The impact of these conditions can be reduced by completing trench excavations during the summer months, when perched groundwater levels are lowest, and by limiting the depths of the trenches.

We anticipate perched groundwater inflow, if encountered, can generally be controlled by pumping from sumps. To facilitate dewatering, it will be necessary to overexcavate the trench bottom to permit installation of a granular working blanket. We estimate the required thickness of the granular working blanket will be on the order of 1 ft, or as required to maintain a stable trench bottom. The actual required depth of overexcavation will depend on the conditions exposed in the trench and the effectiveness of the contractor's dewatering efforts. The thickness of the granular blanket must be evaluated on the basis of field observations during construction. We recommend the use of relatively clean, free-draining material, such as 2- to 4-in.-minus crushed rock, for this purpose. The use of a geotextile fabric over the trench bottom will assist in trench-bottom stability and dewatering.

All utility trench excavations within building and pavement areas should be backfilled with relatively clean, granular material, such as sand, sandy gravel, or crushed rock of up to 1½-in. maximum size and having less than 5% passing the No. 200 sieve (washed analysis). The bottom of the excavation should be thoroughly cleaned to remove loose materials and the utilities should be underlain by a minimum 6-in. thickness of bedding material. The granular backfill material should be compacted to at least 95% of the maximum dry density as determined by ASTM D698 in the upper 5 ft of the trench and at least 92% of this density below a depth of 5 ft. The use of hoe-mounted vibratory-plate compactors is usually most efficient for this purpose. Flooding or jetting as a means of compacting the trench backfill should not be permitted.

Foundation Support

We anticipate column and wall loads will be on the order of 100 kips and 3 kips/ft, respectively. In our opinion, the proposed structural loads can be supported on conventional spread and wall footings in accordance with the following design criteria.

All footings should be established in firm, undisturbed, native soil or compacted structural fill. The base of all new footings should be established at a minimum depth of 18 in. below the lowest adjacent finished grade. The footing width should not be less than 24 in. for isolated column footings and 18 in. for wall footings. Excavations for all foundations should be made with a smooth-edge bucket, and all footing subgrades should be observed by a member of GRI's geotechnical engineering staff. Soft or otherwise unsuitable material encountered at foundation subgrade level should be overexcavated and backfilled with granular structural fill. Due to the presence of localized fill soils and previous development at the site, it should be anticipated some overexcavation of subgrade will be required. In addition, our experience indicates the subgrade soils are easily disturbed by excavation and construction activities. Due to these considerations, we recommend installing a minimum 3-in.-thick layer of compacted crushed rock in the bottom of all footing excavations. Relatively clean, 3/4-in.-minus crushed rock is suitable for this purpose.

We anticipate shallow basalt may be encountered in excavations completed to found the new building additions. If basalt is encountered in foundation excavations, we recommend the foundations be underlain by a minimum 12-in. thickness of compacted crushed rock due to the potentially variable footing support conditions. Relatively clean, 1 1/2- or 3/4-in.-minus crushed rock is suitable for this purpose. In addition, large excavation equipment or excavation methods, such as chipping, splitting, chemical rock breaking, or blasting, will likely be required if basalt is encountered in foundation excavations. More detailed information about rock excavation methods and techniques is provided in the **Rock Excavation** subsection of this report.

Footings established in accordance with these criteria can be designed on the basis of an allowable soil bearing pressure of 4,000 psf. This value applies to the total of dead load and/or frequently applied live loads and can be increased by one-third for the total of all loads: dead, live, and wind or seismic. We estimate the total static settlement of spread and wall footings designed in accordance with the recommendations presented above will be less than 1 in. for footings supporting column and wall loads of up to 100 kips and 3 kips/ft, respectively. Differential static settlements between adjacent, comparably loaded footings on similar subgrade conditions should be less than half the total settlement.

Horizontal shear forces can be resisted partially or completely by frictional forces developed between the base of the footings and the underlying soil and by soil passive resistance. The total frictional resistance between the footing and the soil is the normal force times the coefficient of friction between the soil and the base of the footing. We recommend an ultimate value of 0.35 for the coefficient of friction for footings cast on granular material. The normal force is the sum of the vertical forces (dead load plus real live load). If additional lateral resistance is required, passive earth pressures against embedded footings can be computed on the basis of an equivalent fluid having a unit weight of 300 pcf. This design passive earth pressure would be applicable only if the footing is cast neat against undisturbed soil or if backfill for the footings is placed as granular structural fill and assumes up to 1/2 in. of lateral movement of the structure will occur in order for the soil to develop this resistance. This value also assumes the ground surface in front of the foundation is horizontal, i.e., does not slope downward away from the toe of the footing.

Subdrainage/Floor Support

To provide a capillary break and reduce the risk of damp floors, slab-on-grade floors established at or above adjacent final site grades should be underlain by a minimum 8 in. of free-draining, clean, angular rock. This material should consist of angular rock such as 1 1/2- to 3/4-in. crushed rock with less than 2%

passing the No. 200 sieve (washed analysis) and be placed in one lift and compacted to at least 95% of the maximum dry density (ASTM D698) or until well keyed. To improve workability, the drain rock should be capped with a 2-in.-thick layer of compacted, 3/4-in.-minus crushed rock. In our opinion, it is appropriate to assume a coefficient of subgrade reaction, k , of 175 pci to characterize the subgrade support for point loading with 10 in. of compacted crushed rock beneath the floor slab.

In areas where floor coverings will be provided or moisture-sensitive materials stored, it would be appropriate to also install a vapor-retarding membrane. The membrane should be installed as recommended by the manufacturer. In addition, a foundation drain should be installed around the perimeter of the building additions to collect water that could potentially infiltrate beneath the foundations and should discharge to an approved storm drain.

Although it is anticipated the finished floor elevation for the building will be established near or above the adjacent site grades, if structures, such as floors, are established below the final site grades, the structure should be provided with a subdrainage system. A subdrainage system will reduce the buildup of hydrostatic pressures on the floor slab and the risk of groundwater entering through embedded walls and floor slabs. GRI should be contacted if embedded structures are being considered.

DESIGN REVIEW AND CONSTRUCTION SERVICES

We welcome the opportunity to review and discuss construction plans and specifications for this project as they are being developed. In addition, GRI should be retained to review all geotechnical-related portions of the plans and specifications to evaluate whether they are in conformance with the recommendations provided in our report. To observe compliance with the intent of our recommendations, the design concepts, and the plans and specifications, we are of the opinion that all construction operations dealing with earthwork and foundations should be observed by a GRI representative. Our construction-phase services will allow for timely design changes if site conditions are encountered that are different from those described in our report. If we do not have the opportunity to confirm our interpretations, assumptions, and analyses during construction, we cannot be responsible for the application of our recommendations to subsurface conditions different from those described in this report.

LIMITATIONS

This report has been prepared to aid the architect and engineer in the design of this project. The scope is limited to the specific project and location described herein, and our description of the project represents our understanding of the significant aspects of the project relevant to the design and construction of the new foundations and floors. In the event any changes in the design and location of the project elements as outlined in this report are planned, we should be given the opportunity to review the changes and modify or reaffirm the conclusions and recommendations of this report in writing.

The conclusions and recommendations submitted in this report are based on the data obtained from the explorations made at the locations indicated on Figure 2 and other sources of information discussed in this report. In the performance of subsurface investigations, specific information is obtained at specific locations at specific times. However, it is acknowledged that variations in soil conditions may exist between exploration locations. This report does not reflect any variations that may occur between these explorations. The nature and extent of variation may not become evident until construction. If during construction, subsurface conditions differ from those encountered in the explorations, we should be

advised at once so that we can observe and review these conditions and reconsider our recommendations where necessary.

Please contact the undersigned if you have any questions.

Submitted for GRI,

Wesley Spang, PhD, PE, GE
Principal



Nicholas M. Hatch, PE
Project Engineer

This document has been submitted electronically.

References

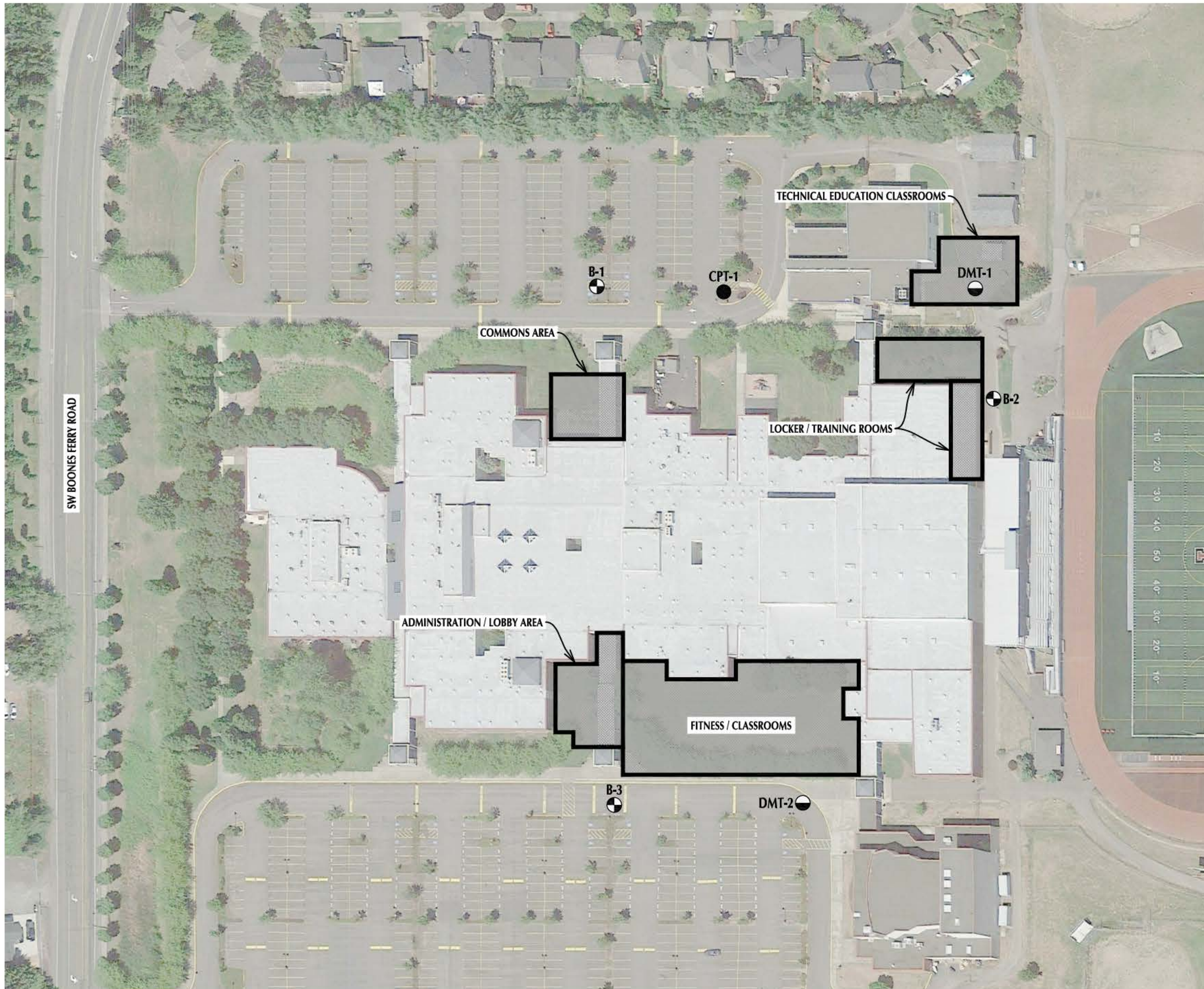
- O'Connor, J.E., Sama-Wojcick, A., Woznikak, K.C., Polette, D.J., and Fleck, R.J., 2001, Origin, extent, and thickness of quaternary geologic units in the Willamette Valle, Oregon: U.S. Geological Survey Professional Paper 1620.
- Personius, S. F., Dart, R. L., Bradley, Lee-Ann, and Haller, K. M., 2003, Map and data for Quaternary faults and folds in Oregon: U.S. Geological Survey Open-File Report 03-095.
- U.S. Geological Survey (USGS), 2014, Unified hazard tool, Conterminous U.S. 2014(v4.0x), accessed 7/24/17 from USGS website: <https://earthquake.usgs.gov/hazards/interactive/>.



-  BORING COMPLETED BY GRI (JUNE 14, 2017)
-  CONE PENETRATION TEST COMPLETED BY GRI (JUNE 2, 2017)
-  DILATOMETER COMPLETED BY GRI (JUNE 2, 2017)

SITE MAP FROM GOOGLE EARTH PRO, DATED JULY 23, 2016

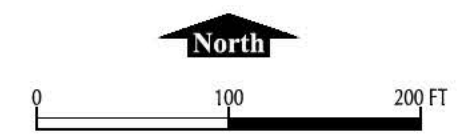

GRI TIGARD TUALATIN SCHOOL DISTRICT 23J
TUALATIN HIGH SCHOOL

SITE MAP

APPENDIX A

Field Explorations and Laboratory Testing

APPENDIX A

FIELD EXPLORATIONS AND LABORATORY TESTING

FIELD EXPLORATIONS

Subsurface materials and conditions at the site were investigated between June 2 and June 14, 2017, with three borings, designated B-1 through B-3; one cone penetrometer test (CPT) sounding, designated CPT-1; and two dilatometer (DMT) soundings, designated DMT-1 and DMT-2. The approximate locations of the explorations completed for this investigation are shown on Figure 2. Logs of the borings, CPT probe, and DMT soundings are provided on Figures 1A through 7A. The field exploration work was coordinated and documented by an experienced member of GRI's geotechnical engineer staff, who maintained a log of the materials and conditions disclosed during the course of work.

Borings

Three borings, designated B-1 through B-3, were advanced to depths of about 30.2 to 35.1 ft below existing site grades. The borings were completed with mud-rotary drilling and HQ rock-coring techniques using a CME 850 track-mounted drill rig provided and operated by Western States Soil Conservation of Hubbard, Oregon. Disturbed samples of soil and decomposed rock were typically obtained from the borings at 2.5-ft intervals of depth in the upper 15 ft and at 5-ft intervals below this depth. Standard Penetration Tests were conducted at the time of sampling by driving the sampler into the soil a distance of 18 in. using a 140-lb hammer dropped 30 in. The number of blows required to drive the sampler the last 12 in. is known as the Standard Penetration Resistance, or SPT N-value. Samples obtained from the borings were placed in airtight jars and returned to our laboratory for further classification and testing. In addition, rock-core samples of basalt were obtained in boring B-2 below a depth of 25 ft. The rock-core samples were placed in a core box and photos of the rock core are provided on Figure 10A.

A relatively undisturbed sample of soil was obtained at a depth of 5 ft from boring B-2 by pushing a 3-in.-outside-diameter (O.D.) Shelby tube into the undisturbed soil a maximum distance of 24 in. using the hydraulic ram of the drill rig. The soil exposed in the end of the Shelby tube was examined and classified in the field. After classification, the tube was sealed with rubber caps and returned to our laboratory for further examination and testing.

Logs of the borings are provided on Figures 1A through 3A. Each log presents a descriptive summary of the various types of materials encountered in the boring and notes the depths at which the materials and/or characteristics of the materials change. To the right of the descriptive summary, the numbers and types of samples are indicated. Farther to the right, SPT N-values are shown graphically, along with the natural moisture contents, Torvane shear strength values, and percent passing the No. 200 sieve, where applicable. The terms and symbols used to describe the materials encountered in the borings are defined in Tables 1A and 2A and the attached legend.

Electric Cone Penetration Test

One electric CPT probe, designated CPT-1, was advanced to a depth of about 11.3 ft using a truck-mounted CPT rig provided and operated by Oregon Geotechnical Explorations, Inc., of Keizer, Oregon.

During the CPT, a steel cone is forced vertically into the soil at a constant rate of penetration. The force required to cause penetration at a constant rate can be related to the bearing capacity of the soil immediately surrounding the point of the penetrometer cone. This force is measured and recorded every 8 in. In addition to the cone measurements, measurements are obtained of the magnitude of force required to force a friction sleeve, attached above the cone, through the soil. The force required to move the friction sleeve can be related to the undrained shear strength of fine-grained soils. The dimensionless ratio of sleeve friction to point bearing capacity provides an indicator of the type of soil penetrated. The cone-penetration resistance and sleeve friction can be used to evaluate the relative consistency of cohesionless and cohesive soils, respectively. In addition, a piezometer fitted between the cone and the sleeve measures changes in water pressure as the probe is advanced and can also be used to measure the depth of the top of the groundwater table. The probe was also operated using an accelerometer fitted to the probe, which allows measurement of the arrival time of shear waves from impulses generated at the ground surface. This allows calculation of shear-wave velocities for the surrounding soil profile.

A log of the electric CPT probe is provided on Figure 4A, which presents graphical summaries of the tip resistance, local (sleeve) friction, friction ratio, pore pressure, and soil behavior type (SBT) index. The terms used to describe the soils encountered in the probe are defined in Table 3A. Shear-wave velocity measurements were recorded for the probe and are shown on Figure 5A.

Dilatometer Test

Two DMT soundings, designated DMT-1 and DMT-2, were advanced to depths of about 4.6 to 10 ft using a truck-mounted CPT rig provided and operated by Oregon Geotechnical Explorations, Inc., of Keizer, Oregon. DMT soundings provide additional geotechnical information to characterize the subsurface materials. The DMT test is performed by pushing a blade-shaped instrument into the soil. The blade is equipped with an expandable membrane on one side that is pressurized until the membrane moves horizontally into the surrounding soil. Readings of the pressures required to move the membrane to a point flush with the blade (P_0 – pressure) and 1.1 mm into the surrounding soil (P_1 – pressure) are recorded. The test sequence was performed at 8-in. intervals to obtain a comprehensive soil profile. A material index (I_D), horizontal stress index (K_D), and dilatometer modulus (E_D) are obtained directly from the dilatometer data. The constrained modulus (M) is then obtained from the dilatometer data.

The dilatometer test results are summarized on Figures 6A and 7A. The results show the dilatometer pressure readings (P_0 , P_1) and three dilatometer-derived parameters: horizontal stress index (K_D), material index (I_D), and constrained modulus (M). The terms used to describe the materials encountered in the soundings are defined in Table 4A.

LABORATORY TESTING

General

The samples obtained from the borings were examined in our laboratory, where the physical characteristics of the samples were noted and the field classifications modified where necessary. At the time of classification, the natural moisture content of each sample was determined. Additional testing included Torvane shear strength, dry unit weight, Atterberg limits, one-dimensional consolidation, and grain-size analyses. A summary of the laboratory test results has been provided in Table 5A. The following sections describe the testing program in more detail.

Natural Moisture Content

Natural moisture content determinations were made in conformance with ASTM D2216. The results are summarized on Figures 1A through 3A and in Table 5A.

Torvane Shear Strength

The approximate undrained shear strength of fine-grained soils was determined using a Torvane shear device. The Torvane is a hand-held apparatus with vanes that are inserted into the soil. The torque required to fail the soil in shear around the vanes is measured using a calibrated spring. The results of the Torvane shear strength tests are summarized on Figure 2A.

Undisturbed Unit Weight

The unit weight, or density, of undisturbed soil samples was determined in the laboratory in conformance with ASTM D2937. The results are summarized on Figure 2A and in Table 5A.

Atterberg Limits

Atterberg limits testing was performed for one representative sample of silt clay in conformance with ASTM D4318. The test results are summarized on the Plasticity Chart, Figure 8A, and Figure 2A and in Table 5A.

One-Dimensional Consolidation

A one-dimensional consolidation test was performed in conformance with ASTM D2435 on a relatively undisturbed soil sample extruded from a Shelby tube. This test provides data on the compressibility of underlying fine-grained soils, necessary for settlement studies. The test results are summarized on Figure 9A in the form of a curve showing percent strain versus applied effective stress. The initial dry unit weight and moisture content of the sample are also shown on the figure.

Grain-Size Analysis

Washed-Sieve Method. To assist in classification of the soils, samples of known dry weight were washed over a No. 200 sieve. The material retained on the sieve was oven-dried and weighed. The percentage of material passing the No. 200 sieve was then calculated. The results are summarized on Figures 1A and 3A and in Table 5A.

Table 1A

GUIDELINES FOR CLASSIFICATION OF SOIL

Description of Relative Density for Granular Soil

Relative Density	Standard Penetration Resistance (N-values), blows per ft
very loose	0 - 4
loose	4 - 10
medium dense	10 - 30
dense	30 - 50
very dense	over 50

Description of Consistency for Fine-Grained (Cohesive) Soils

Consistency	Standard Penetration Resistance (N-values), blows per ft	Torvane or Undrained Shear Strength, tsf
very soft	0 - 2	less than 0.125
soft	2 - 4	0.125 - 0.25
medium stiff	4 - 8	0.25 - 0.50
stiff	8 - 15	0.50 - 1.0
very stiff	15 - 30	1.0 - 2.0
hard	over 30	over 2.0

Grain-Size Classification	Modifier for Subclassification		
<i>Boulders:</i> > 12 in.		Primary Constituent SAND or GRAVEL	Primary Constituent SILT or CLAY
<i>Cobbles:</i> 3 - 12 in.	Adjective	Percentage of Other Material (by weight)	
<i>Gravel:</i> 1/4 - 3/4 in. (fine) 3/4 - 3 in. (coarse)	trace: some: sandy, gravelly:	5 - 15 (sand, gravel) 15 - 30 (sand, gravel) 30 - 50 (sand, gravel)	5 - 15 (sand, gravel) 15 - 30 (sand, gravel) 30 - 50 (sand, gravel)
<i>Sand:</i> No. 200 - No. 40 sieve (fine) No. 40 - No. 10 sieve (medium) No. 10 - No. 4 sieve (coarse)	trace: some: silty, clayey:	< 5 (silt, clay) 5 - 12 (silt, clay) 12 - 50 (silt, clay)	<i>Relationship of clay and silt determined by plasticity index test</i>
<i>Silt/Clay:</i> pass No. 200 sieve			

Table 2A: GUIDELINES FOR CLASSIFICATION OF ROCK

RELATIVE ROCK WEATHERING SCALE

Term	Field Identification
Fresh	Crystals are bright. Discontinuities may show some minor surface staining. No discoloration in rock fabric.
Slightly Weathered	Rock mass is generally fresh. Discontinuities are stained and may contain clay. Some discoloration in rock fabric. Decomposition extends up to 1 in. into rock.
Moderately Weathered	Rock mass is decomposed 50% or less. Significant portions of rock show discoloration and weathering effects. Crystals are dull and show visible chemical alteration. Discontinuities are stained and may contain secondary mineral deposits.
Predominantly Decomposed	Rock mass is more than 50% decomposed. Rock can be excavated with geologist's pick. All discontinuities exhibit secondary mineralization. Complete discoloration of rock fabric. Surface of core is friable and usually pitted due to washing out of highly altered minerals by drilling water.
Decomposed	Rock mass is completely decomposed. Original rock "fabric" may be evident. May be reduced to soil with hand pressure.

RELATIVE ROCK HARDNESS SCALE

Term	Hardness Designation	Field Identification	Approximate Unconfined Compressive Strength
Extremely Soft	R0	Can be indented with difficulty by thumbnail. May be moldable or friable with finger pressure.	< 100 psi
Very Soft	R1	Crumbles under firm blows with point of a geology pick. Can be peeled by a pocket knife and scratched with fingernail.	100 - 1,000 psi
Soft	R2	Can be peeled by a pocket knife with difficulty. Cannot be scratched with fingernail. Shallow indentation made by firm blow of geology pick.	1,000 - 4,000 psi
Medium Hard	R3	Can be scratched by knife or pick. Specimen can be fractured with a single firm blow of hammer/geology pick.	4,000 - 8,000 psi
Hard	R4	Can be scratched with knife or pick only with difficulty. Several hard hammer blows required to fracture specimen.	8,000 - 16,000 psi
Very Hard	R5	Cannot be scratched by knife or sharp pick. Specimen requires many blows of hammer to fracture or chip. Hammer rebounds after impact.	> 16,000 psi

RQD AND ROCK QUALITY

Relation of RQD and Rock Quality		Terminology for Planar Surface		
RQD (Rock Quality Designation), %	Description of Rock Quality	Bedding	Joints and Fractures	Spacing
0 - 25	Very Poor	Laminated	Very Close	< 2 in.
25 - 50	Poor	Thin	Close	2 in. – 12 in.
50 - 75	Fair	Medium	Moderately Close	12 in. – 36 in.
75 - 90	Good	Thick	Wide	36 in. – 10 ft
90 - 100	Excellent	Massive	Very Wide	> 10 ft



Table 3A: CONE PENETRATION TEST (CPT) CORRELATIONS

COHESIVE SOILS

Cone-Tip Resistance, tsf	Consistency
< 5	Very Soft
5 to 15	Soft to Medium Stiff
15 to 30	Stiff
30 to 60	Very Stiff
> 60	Hard

COHESIONLESS SOILS

Cone-Tip Resistance, tsf	Relative Density
< 20	Very Loose
20 to 40	Loose
40 to 120	Medium
120 to 200	Dense
> 200	Very Dense

Reference

Kulhawy, F.H., and Mayne, P.W., 1990, Manual on estimating soil properties for foundation design: Electric Power Research Institute, EL-6800.

**Table 4A: SOIL CHARACTERIZATION
BASED ON MARCHETTI FLAT-PLATE DILATOMETER TEST**

Description of Consistency for Fine-Grained (Cohesive) Soils

Consistency	Soil Type⁽¹⁾	
	CH, CL	ML, MH
	DMT Constrained Modulus (M_{DMT}), tsf	
	$I_D^{(2)} < 0.6$	$0.6 < I_D^{(2)} < 1.8$
Very Soft	0 - 30	0 - 50
Soft	30 - 60	50 - 100
Medium Stiff	60 - 100	100 - 200
Stiff	100 - 175	200 - 375
Very Stiff	175 +	375 +

Description of Relative Density for Granular Soils

Relative Density	Soil Type⁽¹⁾	
	SM, SC	SP, SW
	DMT Constrained Modulus (M_{DMT}), tsf	
	$1.8 < I_D^{(2)} < 3.3$	$3.3 < I_D^{(2)}$
Very Loose	0 - 75	0 - 100
Loose	75 - 150	100 - 200
Medium Dense	150 - 300	200 - 425
Dense	300 - 550	425 - 850
Very Dense	550 +	850 +

1) Unified Soil Classification System

2) I_D = Material Index

Table 5A
SUMMARY OF LABORATORY RESULTS

Sample Information				Atterberg Limits				Fines Content, %	Soil Type
Location	Sample	Depth, ft	Elevation, ft	Moisture Content, %	Dry Unit Weight, pcf	Liquid Limit, %	Plasticity Index, %		
B-1	S-1	2.5	—	20	—	—	—	—	FILL
	S-2	5.0	—	48	—	—	—	49	Silty SAND
B-2	S-1	2.5	—	27	—	—	—	—	Clayey SILT
	S-2	5.5	—	31	—	—	—	—	Clayey SILT
	S-2	6.2	—	36	88	—	—	—	Silty CLAY
	S-3	7.0	—	36	—	63	36	—	Silty CLAY
	S-4	10.0	—	31	—	—	—	—	Silty CLAY
B-3	S-1	2.5	—	53	—	—	—	56	Sandy SILT

BORING AND TEST PIT LOG LEGEND

SOIL SYMBOLS

Symbol	Typical Description
	LANDSCAPE MATERIALS
	FILL
	GRAVEL; clean to some silt, clay, and sand
	Sandy GRAVEL; clean to some silt and clay
	Silty GRAVEL; up to some clay and sand
	Clayey GRAVEL; up to some silt and sand
	SAND; clean to some silt, clay, and gravel
	Gravelly SAND; clean to some silt and clay
	Silty SAND; up to some clay and gravel
	Clayey SAND; up to some silt and gravel
	SILT; up to some clay, sand, and gravel
	Gravelly SILT; up to some clay and sand
	Sandy SILT; up to some clay and gravel
	Clayey SILT; up to some sand and gravel
	CLAY; up to some silt, sand, and gravel
	Gravelly CLAY; up to some silt and sand
	Sandy CLAY; up to some silt and gravel
	Silty CLAY; up to some sand and gravel
	PEAT

BEDROCK SYMBOLS

Symbol	Typical Description
	BASALT
	MUDSTONE
	SILTSTONE
	SANDSTONE

SURFACE MATERIAL SYMBOLS

Symbol	Typical Description
	Asphalt concrete PAVEMENT
	Portland cement concrete PAVEMENT
	Crushed rock BASE COURSE

SAMPLER SYMBOLS

Symbol	Sampler Description
	2.0-in. O.D. split-spoon sampler and Standard Penetration Test with recovery (ASTM D1586)
	Shelby tube sampler with recovery (ASTM D1587)
	3.0-in. O.D. split-spoon sampler with recovery (ASTM D3550)
	Grab Sample
	Rock core sample interval
	Sonic core sample interval
	Geoprobe sample interval

INSTALLATION SYMBOLS

Symbol	Symbol Description
	Flush-mount monument set in concrete
	Concrete, well casing shown where applicable
	Bentonite seal, well casing shown where applicable
	Filter pack, machine-slotted well casing shown where applicable
	Grout, vibrating-wire transducer cable shown where applicable
	Vibrating-wire pressure transducer
	1-in.-diameter solid PVC
	1-in.-diameter hand-slotted PVC
	Grout, inclinometer casing shown where applicable

FIELD MEASUREMENTS

Symbol	Typical Description
	Groundwater level during drilling and date measured
	Groundwater level after drilling and date measured
	Rock core recovery (%)
	Rock quality designation (RQD, %)

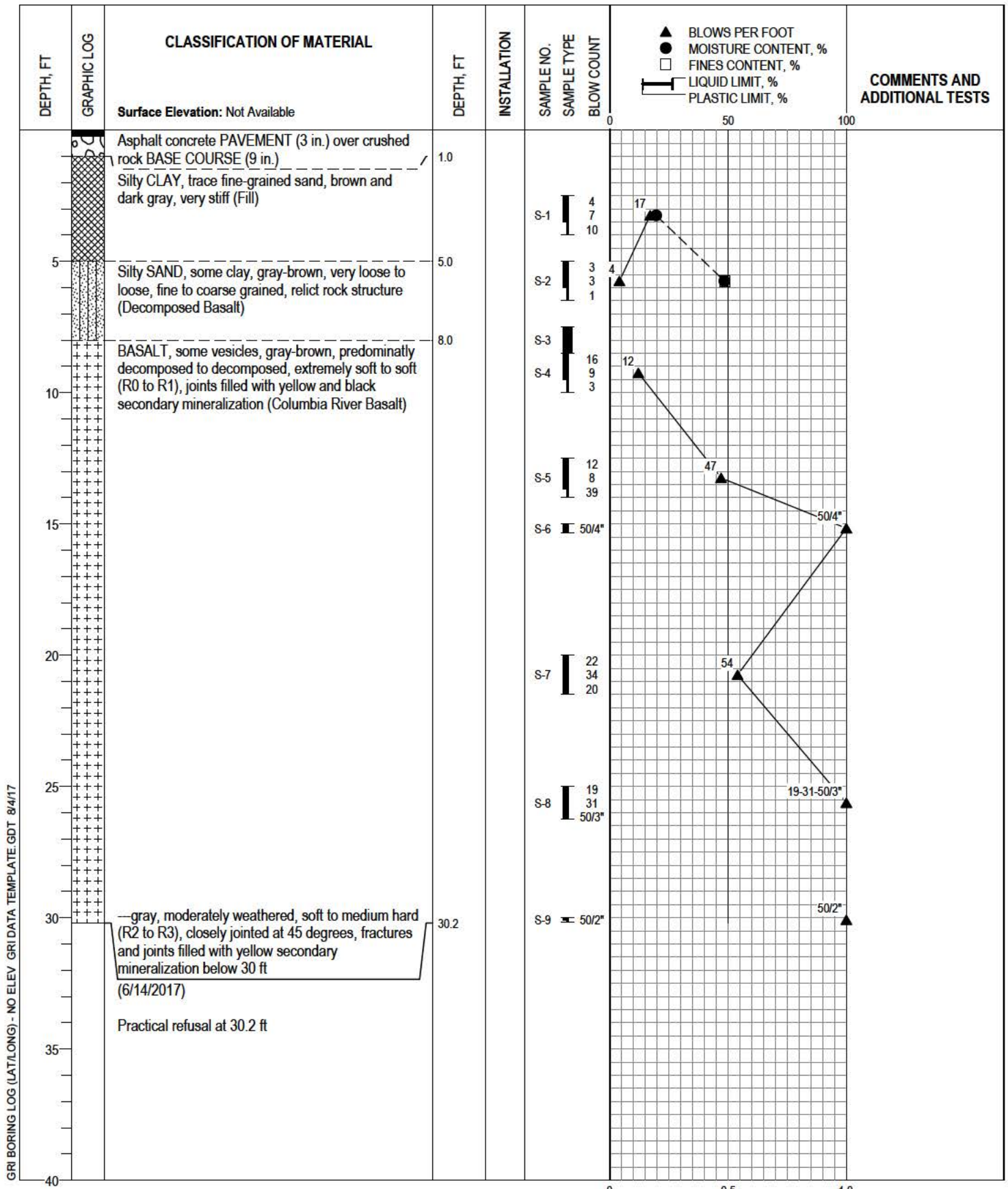

GRI BORING LOG (LAT/LONG) - NO ELEV GRI DATA TEMPLATE GDT 8/4/17

Logged By: T. Meskele	Drilled by: Western States Soil Conservation, Inc.
Date Started: 6/14/17	Coordinates: Not Available
Drilling Method: Mud Rotary	Hammer Type: Auto Hammer
Equipment: CME 850 Track-Mounted Drill Rig	Weight: 140 lb
Hole Diameter: 4 in.	Drop: 30 in.
Note: See Legend for Explanation of Symbols	Energy Ratio:

- ◆ TORVANE SHEAR STRENGTH, TSF
- UNDRAINED SHEAR STRENGTH, TSF



BORING B-1

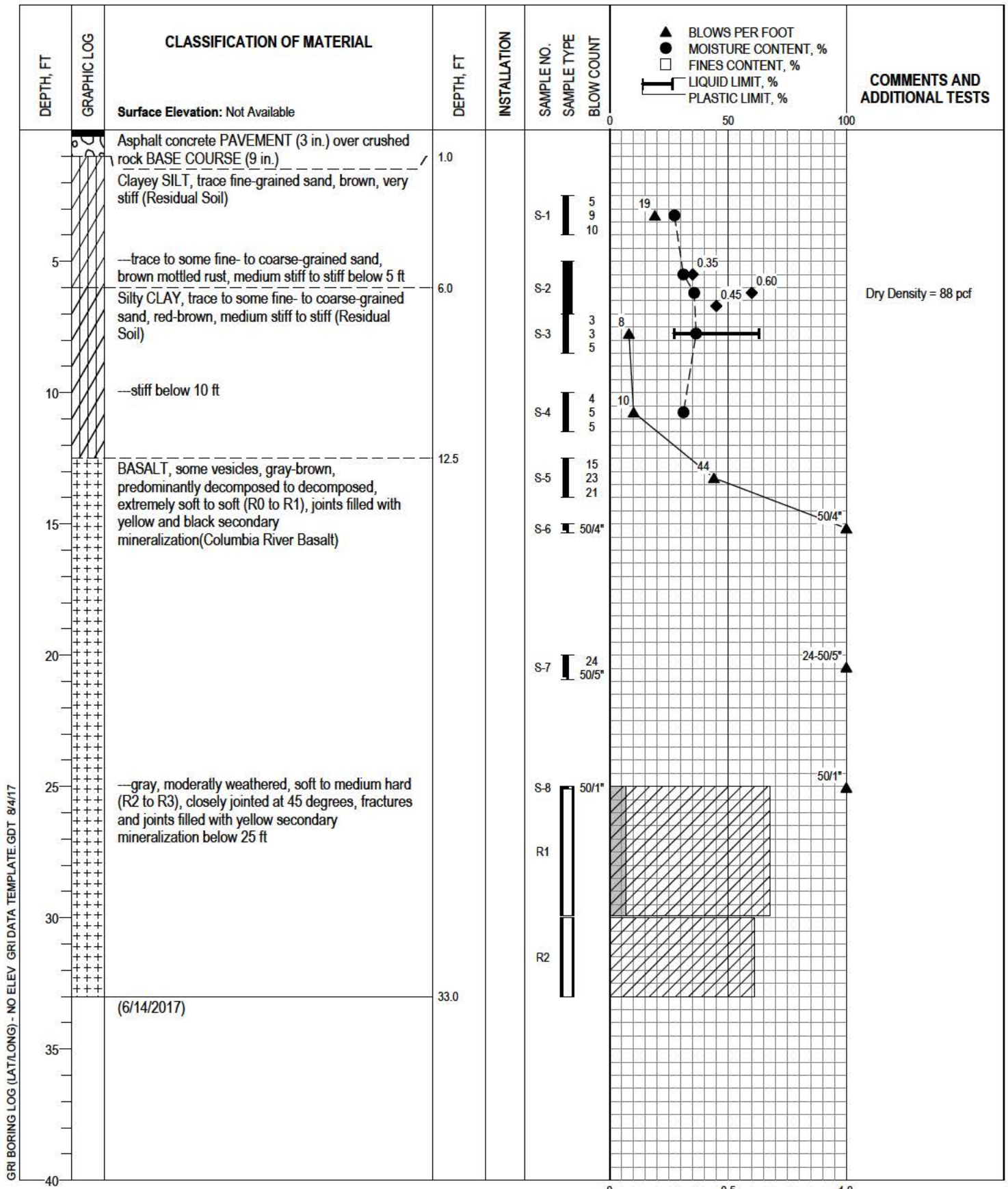

GRI BORING LOG (LAT/LONG) - NO ELEV GRI DATA TEMPLATE GDT 8/4/17

Logged By: T. Meskele		Drilled by: Western States Soil Conservation, Inc.	
Date Started: 6/14/17		Coordinates: Not Available	
Drilling Method: Mud Rotary		Hammer Type: Auto Hammer	
Equipment: CME 850 Track-Mounted Drill Rig		Weight: 140 lb	
Hole Diameter: 4 in.		Drop: 30 in.	
Note: See Legend for Explanation of Symbols		Energy Ratio:	



BORING B-2

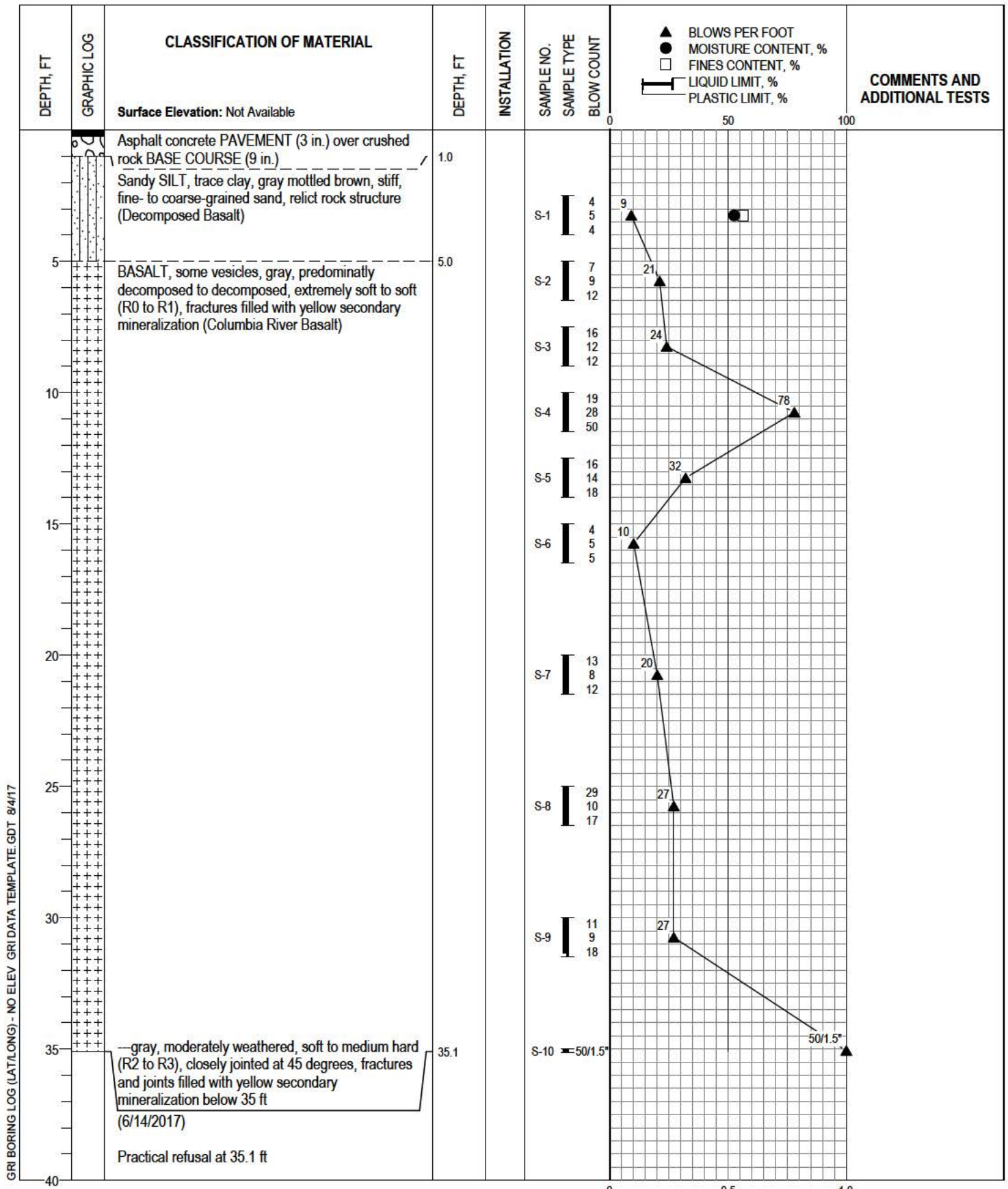

GRI BORING LOG (LAT/LONG) - NO ELEV GRI DATA TEMPLATE.GDT 8/4/17

Logged By: T. Meskele	Drilled by: Western States Soil Conservation, Inc.
Date Started: 6/14/17	Coordinates: Not Available
Drilling Method: Mud Rotary	Hammer Type: Auto Hammer
Equipment: CME 850 Track-Mounted Drill Rig	Weight: 140 lb
Hole Diameter: 4 in.	Drop: 30 in.
Note: See Legend for Explanation of Symbols	Energy Ratio:

◆ TORVANE SHEAR STRENGTH, TSF
■ UNDRAINED SHEAR STRENGTH, TSF



BORING B-3

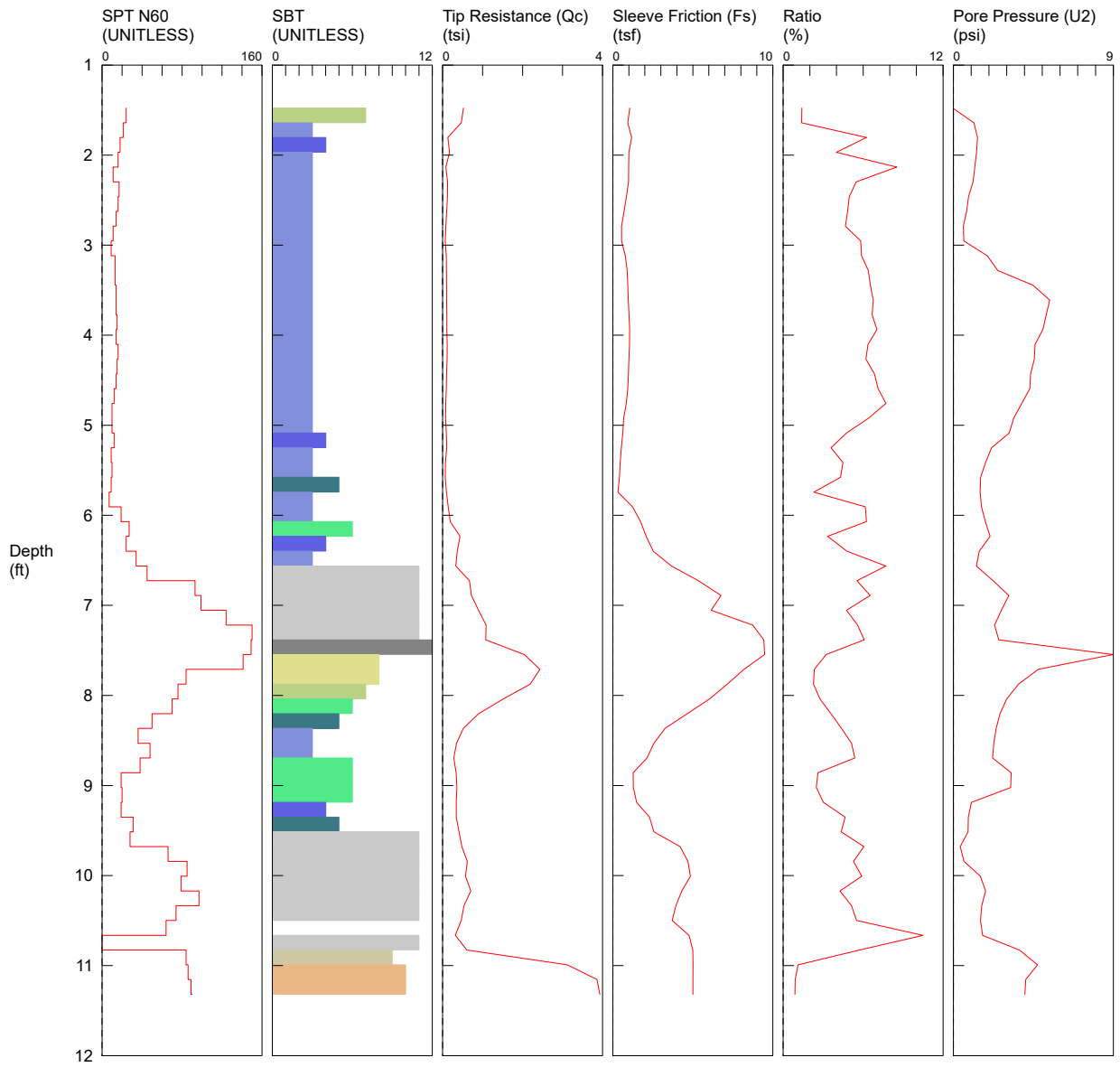

TOTAL DEPTH: 11.319 ft

- | | | | |
|--------------------------|-----------------------------|----------------------------|--------------------------------|
| 1 sensitive fine grained | 4 silty clay to clay | 7 silty sand to sandy silt | 10 gravelly sand to sand |
| 2 organic material | 5 clayey silt to silty clay | 8 sand to silty sand | 11 very stiff fine grained (*) |
| 3 clay | 6 sandy silt to clayey silt | 9 sand | 12 sand to clayey sand (*) |

*SBT/SPT CORRELATION: UBC-1983



Observed By: A. Strahler	Advanced By: Oregon Geotechnical Explorations, Inc.
Date Started: 06/02/17	Ground Surface Elevation: Not Available
Coordinates: Not Available	

CONE PENETRATION TEST CPT-1

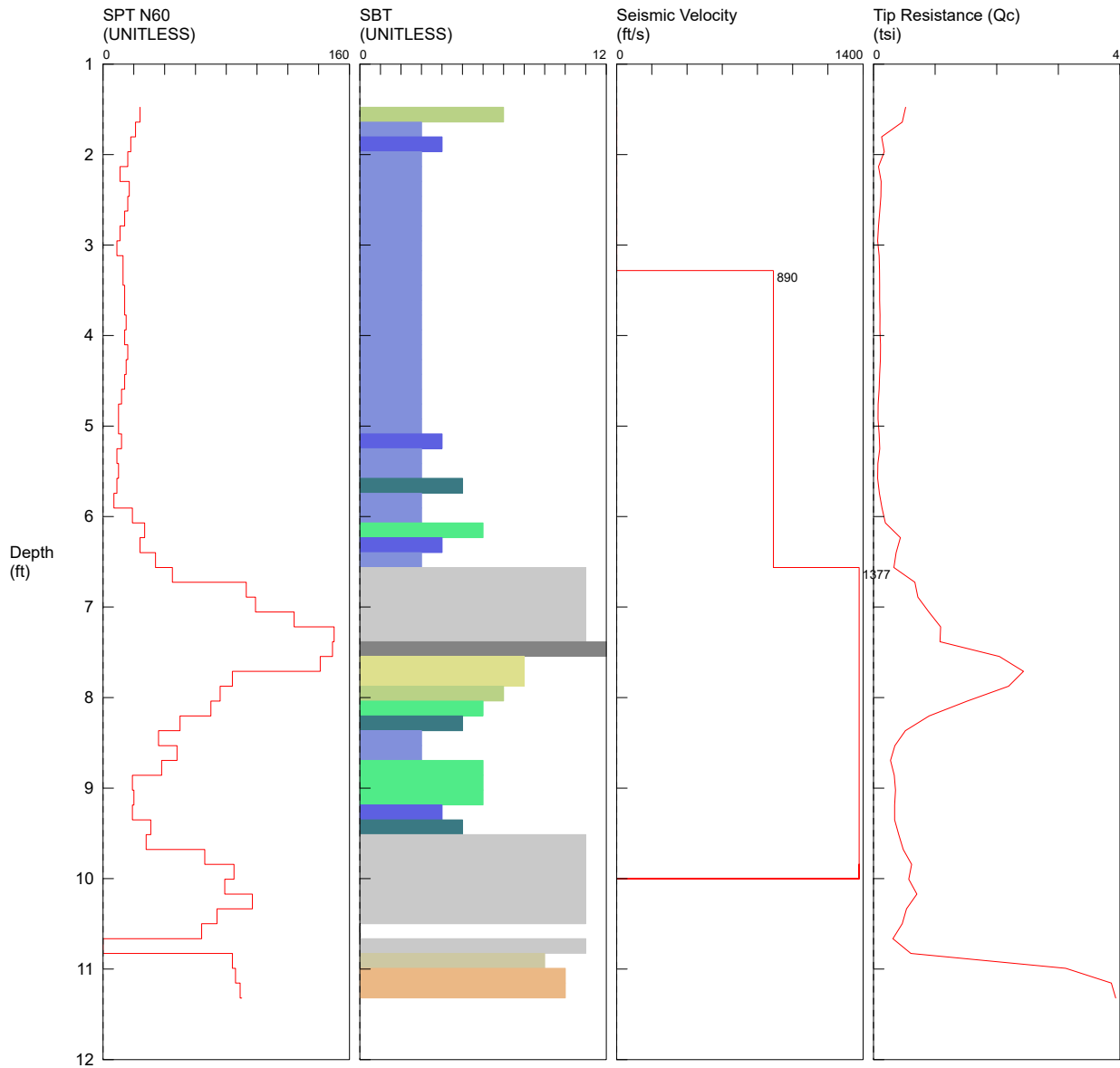

TOTAL DEPTH: 11.319 ft

- | | | | |
|--------------------------|-----------------------------|----------------------------|--------------------------------|
| 1 sensitive fine grained | 4 silty clay to clay | 7 silty sand to sandy silt | 10 gravelly sand to sand |
| 2 organic material | 5 clayey silt to silty clay | 8 sand to silty sand | 11 very stiff fine grained (*) |
| 3 clay | 6 sandy silt to clayey silt | 9 sand | 12 sand to clayey sand (*) |

*SBT/SPT CORRELATION: UBC-1983



Observed By: A. Strahler	Advanced By: Oregon Geotechnical Explorations, Inc.
Date Started: 06/02/17	Ground Surface Elevation: Not Available
Coordinates: Not Available	

CONE PENETRATION TEST CPT-1 (SEISMIC VELOCITY PROFILE)

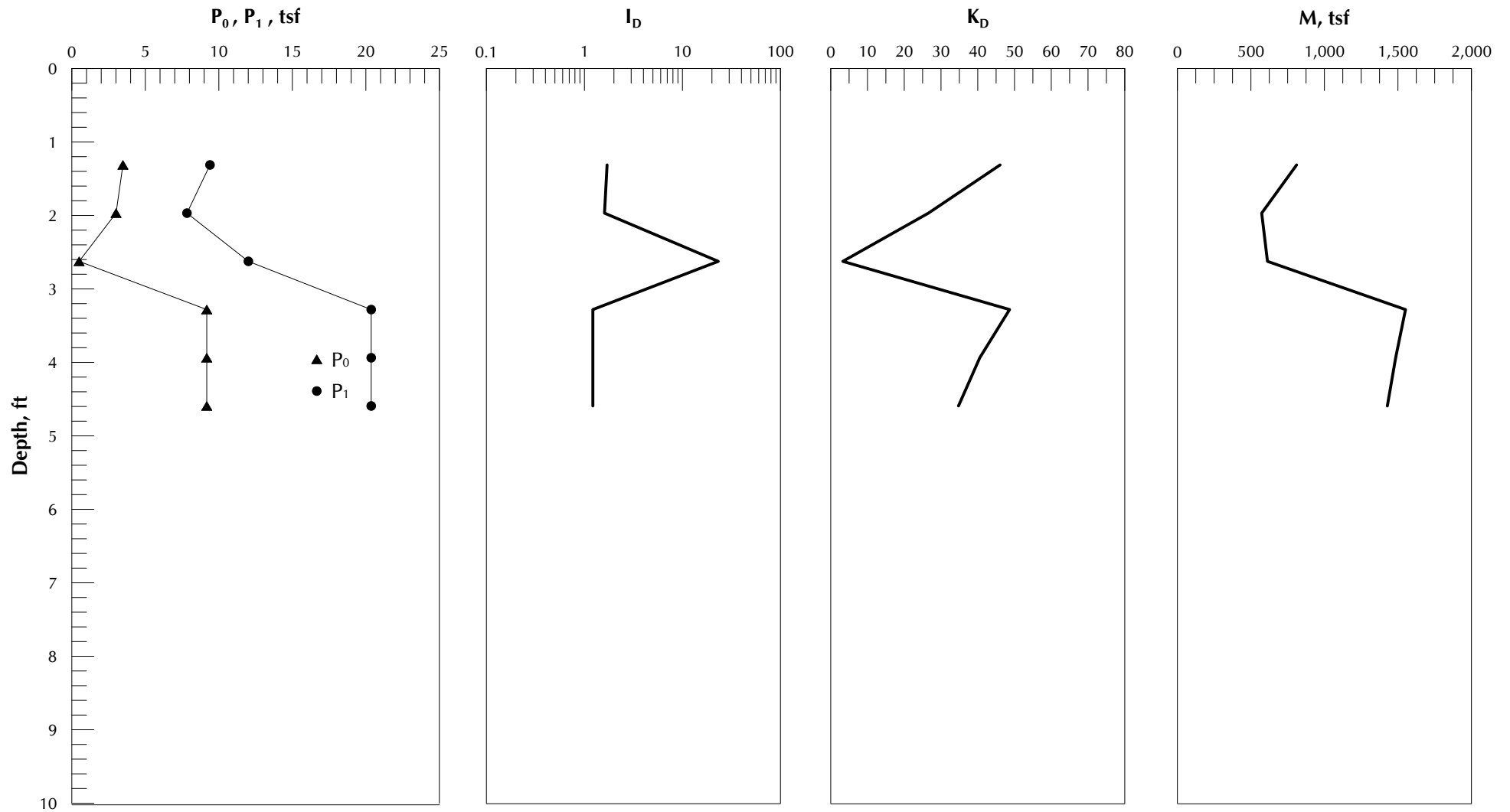

DILATOMETER SOUNDING
DMT-1

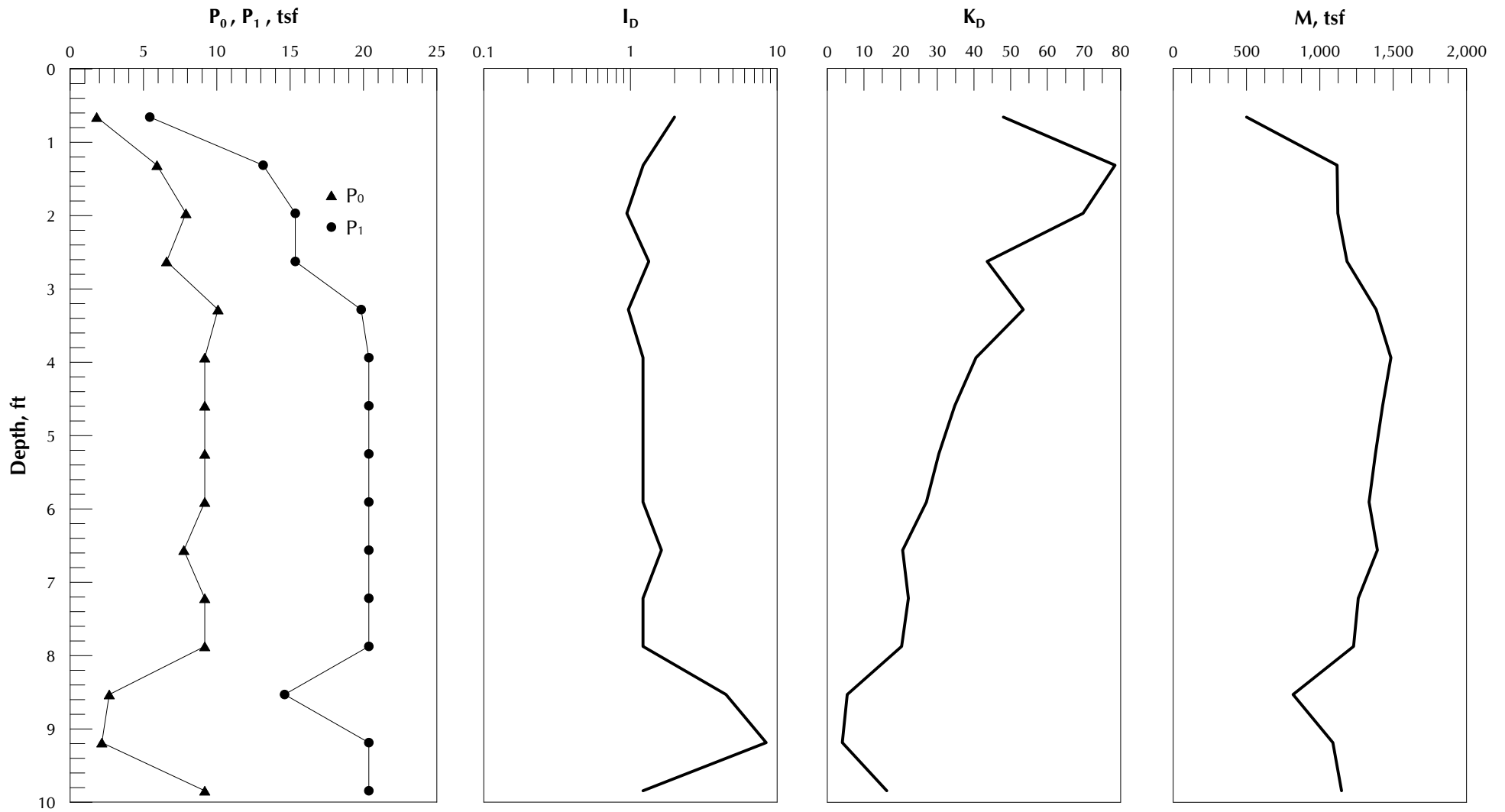

DILATOMETER SOUNDING
DMT-2

GROUP SYMBOL	UNIFIED SOIL CLASSIFICATION FINE-GRAINED SOIL GROUPS
OL	ORGANIC SILTS AND ORGANIC SILTY CLAYS OF LOW PLASTICITY
ML	INORGANIC CLAYEY SILTS TO VERY FINE SANDS OF SLIGHT PLASTICITY
CL	INORGANIC CLAYS OF LOW TO MEDIUM PLASTICITY

GROUP SYMBOL	UNIFIED SOIL CLASSIFICATION FINE-GRAINED SOIL GROUPS
OH	ORGANIC CLAYS OF MEDIUM TO HIGH PLASTICITY, ORGANIC SILTS
MH	INORGANIC SILTS AND CLAYEY SILT
CH	INORGANIC CLAYS OF HIGH PLASTICITY

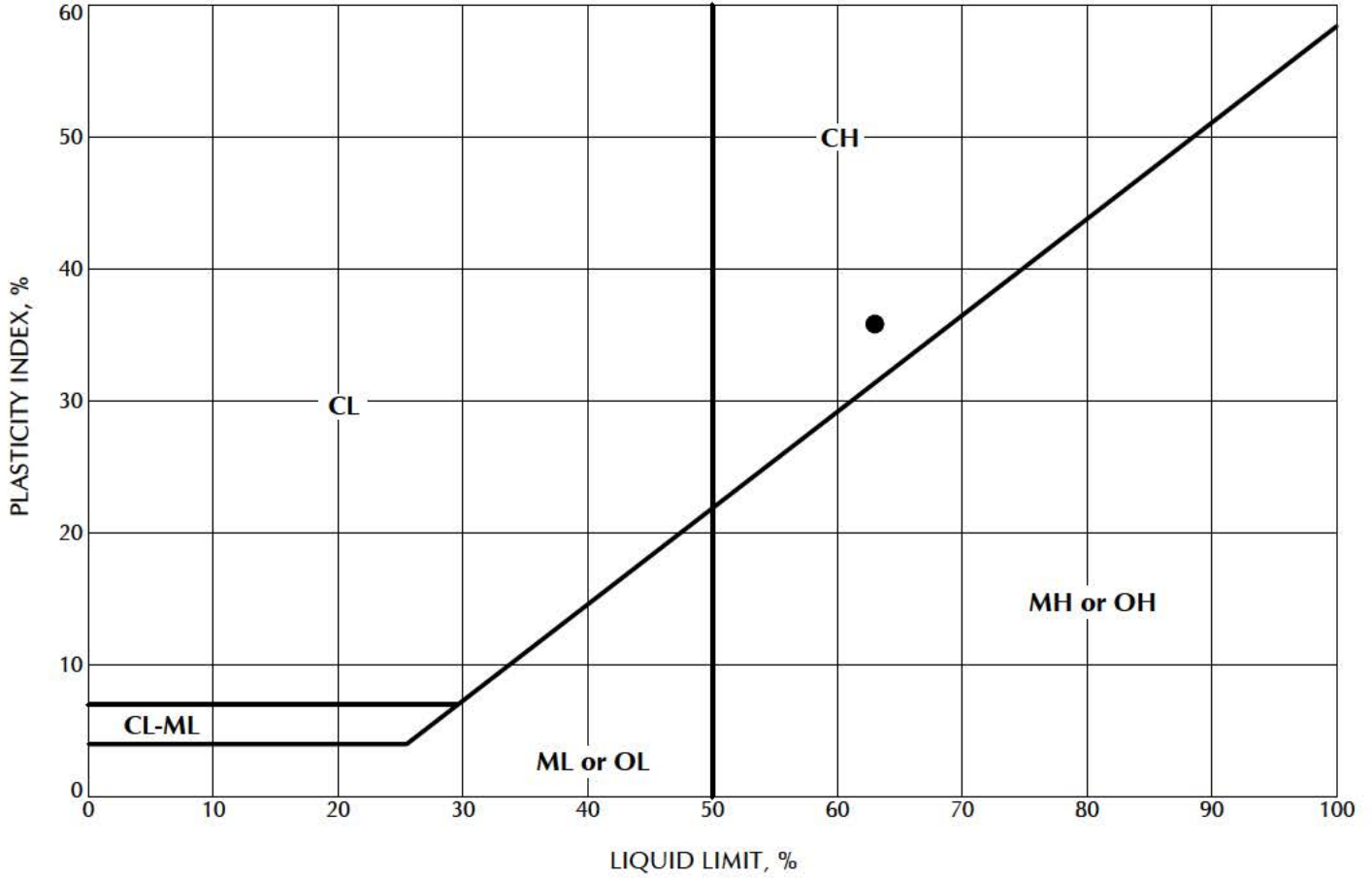

Location	Sample	Depth, ft	Classification	LL	PL	PI	MC, %
● B-2	S-3	7.0	Silty CLAY, trace to some fine- to coarse-grained sand, red-brown (Residual Soil)	63	27	36	36



PLASTICITY CHART

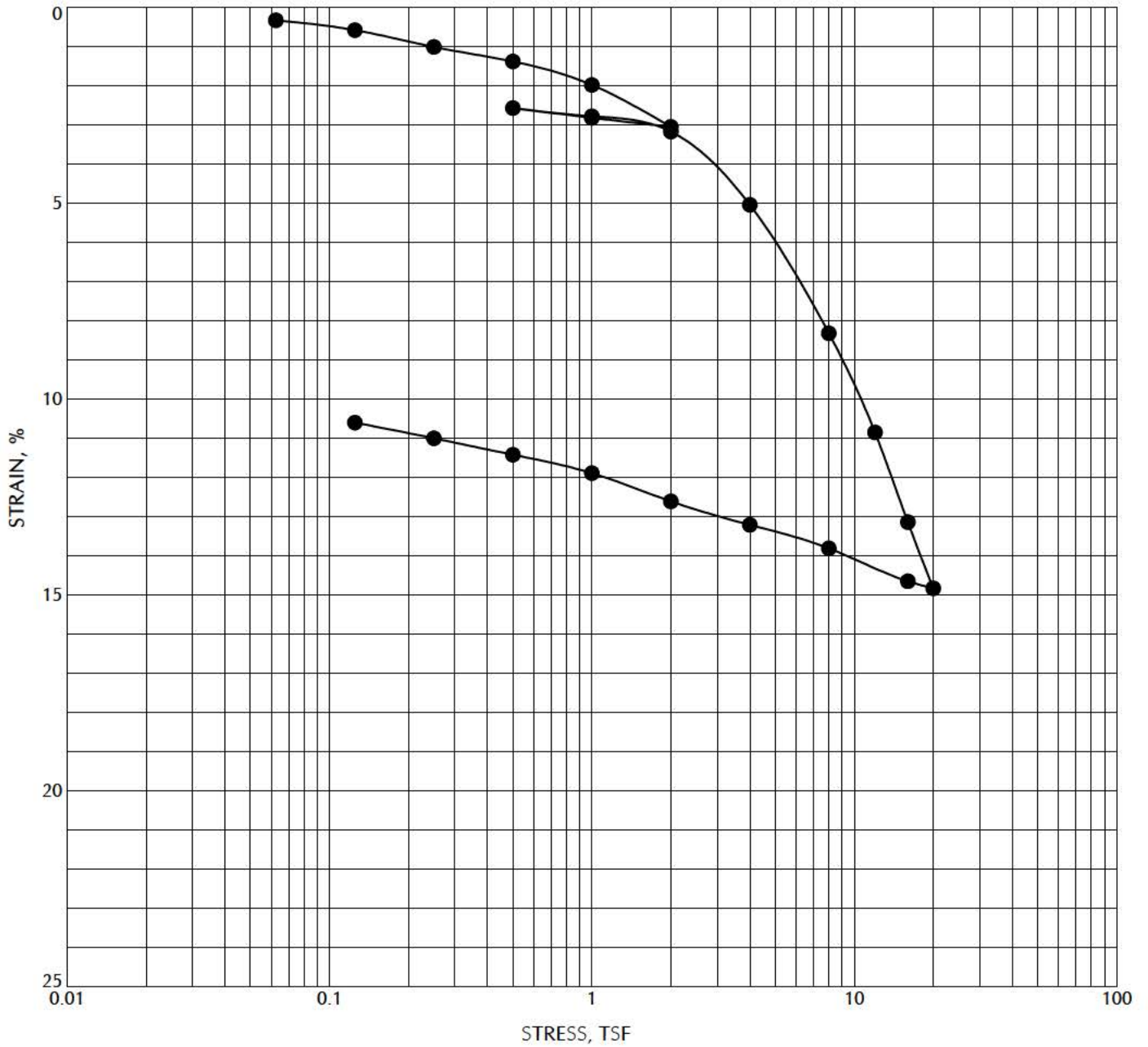

●	Location	Sample	Depth, ft	Classification	Initial	
					γ_d , pcf	MC, %
●	B-2	S-2	6.0	Silty CLAY, trace to some fine- to coarse-grained sand, red-brown, medium stiff to stiff (Residual Soil)	91	33



CONSOLIDATION TEST



ROCK CORE PHOTOGRAPHS

APPENDIX B

Site-Specific Seismic-Hazard Evaluation

APPENDIX B

SITE-SPECIFIC SEISMIC-HAZARD STUDY

GENERAL

GRI completed a site-specific seismic-hazard study for the proposed improvements at Tualatin High School in Tualatin, Oregon. The purpose of our study was to evaluate the potential seismic hazards associated with regional and local seismicity. The site-specific seismic-hazard evaluation is intended to meet the requirements of the 2014 Oregon Structural Specialty Code (OSSC), which is based on the 2012 International Building Code (IBC). Seismic design in accordance with the 2012 IBC is based on American Society of Civil Engineers (ASCE) document 7-10, titled "Minimum Design Loads for Buildings and Other Structures." Our work was based on the potential for regional and local seismic activity, as described in the existing scientific literature, and the subsurface conditions at the site, as disclosed by the subsurface explorations completed for this project. Specifically, our work included the following tasks:

- 1) A detailed review of available literature, including published papers, maps, open-file reports, seismic histories and catalogs, works in progress, and other sources of information regarding the tectonic setting, regional and local geology, and historical seismic activity that might have a significant effect on the site.
- 2) Compilation and evaluation of subsurface data collected at and in the vicinity of the site, including classification and laboratory analyses of soil samples, and review of shear-wave velocity surveys completed at the site. This information was used to prepare a generalized subsurface profile for the site.
- 3) Identification of the potential seismic events (earthquakes) appropriate for the site and characterization of those events in terms of a generalized design event.
- 4) Office studies based on the generalized subsurface profile and the generalized design earthquake resulting in conclusions and recommendations concerning the following:
 - a) specific seismic events that might have a significant effect on the site,
 - b) the potential for seismic energy amplification and liquefaction or soil-strength loss at the site, and
 - c) site-specific acceleration response spectra for design of the proposed structure.

This appendix describes the work accomplished and summarizes our conclusions and recommendations.

Geologic Setting

On a regional scale, the site is located at the northern end of the Willamette Valley, a broad, gently deformed, north-south-trending topographic feature separating the Coast Range to the west from the Cascade Mountains to the east. The site is located approximately 75 km inland from the Cascadia Subduction Zone (CSZ), an active plate boundary along which remnants of the Farallon plate (the Gorda, Juan de Fuca, and Explorer plates) are being subducted beneath the western edge of the North American

plate. The subduction zone is a broad, eastward-dipping zone of contact between the upper portion of the subducting slabs of the Gorda, Juan de Fuca, and Explorer plates and the overriding North American plate, as shown on the Tectonic Setting Summary, Figure 1B.

On a local scale, the site is located in the Tualatin Basin, a large, well-defined, southeast-trending structural basin bounded by high-angle, northwest-trending, right-lateral, strike-slip faults considered to be seismogenic. The geologic units in the area are shown on the Regional Geologic Map, Figure 2B. The distribution of nearby Quaternary faults is shown on the Local Fault Map, Figure 3B. Information regarding the continuity and potential activity of these faults is lacking due largely to the scale at which geologic mapping in the area has been conducted and the presence of thick, relatively young, basin-filling sediments that obscure underlying structural features. Other faults may be present within the basin, but clear stratigraphic and/or geophysical evidence regarding their location and extent is not presently available. Additional discussion regarding crustal faults is provided in the **Local Crustal Event** section below.

Because of the proximity of the site to the CSZ and its location within the Tualatin Basin, three distinctly different sources of seismic activity contribute to the potential for the occurrence of damaging earthquakes. Each of these sources is generally considered to be capable of producing damaging earthquakes. Two of these sources are associated with the deep-seated tectonic activity related to the subduction zone; the third is associated with movement on the local, relatively shallow structures within and adjacent to the Tualatin Basin.

Subsurface and Geologic Conditions. Published geologic mapping indicates the site is mantled with residual soils produced from the weathering of the underlying Columbia River Basalt (O'Connor et al., 2001). These residual soils typically consist of brown to red-brown silt and clay soils of relatively high plasticity that exhibit relict structure of the weathered rock. The weathering profile of the basalt grades from residual soil to hard rock with increasing depth within a given flow. The hard basalt is generally highly to moderately fractured and moderately weathered. It is not uncommon to have this weathering sequence repeated; the interflow zones commonly exhibit soil-like characteristics and frequently transmit groundwater.

Seismicity

General. The geologic and seismologic information available for identifying the potential seismicity at the site is incomplete, and large uncertainties are associated with estimates of the probable magnitude, location, and frequency of occurrence of earthquakes that might affect the site. The available information indicates the potential seismic sources that may affect the site can be grouped into three independent categories: *subduction zone events* related to a sudden slip between the upper surface of the Juan de Fuca plate and the lower surface of the North American plate, *subcrustal events* related to deformation and volume changes within the subducted mass of the Juan de Fuca plate, and *local crustal events* associated with movement on shallow, local faults within and adjacent to the Tualatin Basin. Based on our review of currently available information, we developed generalized design earthquakes for each of these categories. The design earthquakes are characterized by three important properties: size, location relative to the subject site, and the peak horizontal bedrock accelerations produced by the event. In this study, earthquake size is expressed by the moment magnitude (M_w); location is expressed as the closest distance

to the fault rupture, measured in kilometers; and peak horizontal bedrock accelerations are expressed in units of gravity ($1\text{ g} = 32.2\text{ ft/sec}^2 = 981\text{ cm/sec}^2$).

Subduction Zone Event. The last interplate earthquake on the CSZ occurred in January 1700. Geological studies show that great megathrust earthquakes have occurred repeatedly in the past 7,000 years (Atwater et al., 1995; Clague, 1997; Goldfinger et al., 2003; and Kelsey et al., 2005), and geodetic studies (Hyndman and Wang, 1995; Savage et al., 2000) indicate rate of strain accumulation consistent with the assumption that the CSZ is locked beneath offshore northern California, Oregon, Washington, and southern British Columbia (Fluck et al., 1997; Wang et al., 2001). Numerous geological and geophysical studies suggest the CSZ may be segmented (Hughes and Carr, 1980; Weaver and Michaelson, 1985; Guffanti and Weaver, 1988; Goldfinger, 1994; Kelsey and Bockheim, 1994; Mitchell et al., 1994; Personius, 1995; Nelson and Personius, 1996; Witter, 1999), but the most recent studies suggest that for the last great earthquake in 1700, most of the subduction zone ruptured in a single M_w 9.0 earthquake (Satake et al., 1996; Atwater and Hemphill-Haley, 1997; Clague et al., 2000). Published estimates of the probable maximum size of subduction zone events range from moment magnitude M_w 8.3 to >9.0 . Numerous detailed studies of coastal subsidence, tsunamis, and turbidites yield a wide range of recurrence intervals, but the most complete records ($>4,000$ years) indicate average intervals of 350 to 600 years between great earthquakes on the CSZ (Adams, 1990; Atwater and Hemphill-Haley, 1997; Witter, 1999; Clague et al., 2000; Kelsey et al., 2002; Kelsey et al., 2005; Witter et al., 2003). Tsunami inundation in buried marshes along the Washington and Oregon coast and stratigraphic evidence from the Cascadia margin support these recurrence intervals (Kelsey et al., 2005; Goldfinger et al., 2003).

The U.S. Geological Survey (USGS) probabilistic analysis assumes four potential locations of the eastern edge of the earthquake rupture zone, shown on Figure 4B. The 2008 USGS mapping effort indicates three rupture scenarios are assumed to represent these interface events: 1) M_w 9.0 ± 0.2 events that rupture the entire CSZ every 500 years, 2) M_w 8.3 to 8.7 events with rupture zones that occur on segments of the CSZ and occur over the entire length of the CSZ during a period of about 500 years, and 3) M_w 8.0 to 8.2 events that rupture only segments of the CSZ every 500 years (Petersen et al., 2008). The assumed distribution of earthquakes is shown on the Assumed Magnitude-Frequency Distribution, Figure 5B. This distribution assumes the larger M_w 9.0 earthquakes likely occur more often than each of the smaller segmented ruptures, as also indicated by the USGS deaggregation for the site. Therefore, for our deterministic analysis, we have chosen to represent the subduction zone event by a design earthquake of M_w 9.0 at a focal depth of 30 km and rupture distance of 75 km. This corresponds to a sudden rupture of the whole length of the Juan de Fuca-North American plate interface with an assumed rupture zone due west of the site. Based on an average of the attenuation relationships published by Atkinson and Macias (2009), Zhao et al. (2006), and Abrahamson et al. (2015), a subduction zone earthquake of this size and location would result in a peak horizontal bedrock acceleration of approximately 0.22 g at the site.

Subcrustal Event. There is no historical record of significant subcrustal, intraslab earthquakes in Oregon. Although both the Puget Sound and northern California region have experienced many of these earthquakes in historical times, Wong (2005) hypothesizes that due to subduction zone geometry, geophysical conditions, and local geology, Oregon may not be subject to intraslab earthquakes. In the Puget Sound area, these moderate to large earthquakes are deep (40 to 60 km) and over 200 km from the deformation front of the subduction zone. Offshore along the northern California coast, the earthquakes are shallower (up to 40 km) and located along the deformation front. Estimates of the probable size,

location, and frequency of subcrustal events in Oregon are generally based on comparisons of the CSZ with active convergent plate margins in other parts of the world and on the historical seismic record for the region surrounding Puget Sound, where significant events known to have occurred within the subducting Juan de Fuca plate have been recorded. Published estimates of the probable maximum size of these events range from moment magnitude M_w 7.0 to 7.5. The 1949, 1965, and 2001 documented subcrustal earthquakes in the Puget Sound area correspond to M_w 7.1, 6.5, and 6.8, respectively. Published information regarding the location and geometry of the subducting zone indicates a focal depth of 50 km is probable (Weaver and Shedlock, 1989). We have chosen to represent the subcrustal event by a design earthquake of magnitude M_w 7.0 at a focal depth of 50 km and a rupture distance of 63 km. Based on the attenuation relationships published by Youngs et al. (1997) and Abrahamson et al. (2015), a subcrustal earthquake of this size and location would result in a peak horizontal bedrock acceleration of approximately 0.15 g at the site.

Local Crustal Event. Sudden crustal movements along relatively shallow, local faults in the Portland area, although rare, have been responsible for local crustal earthquakes. The precise relationship between specific earthquakes and individual faults is not well understood since few of the faults in the area are expressed at the ground surface and the foci of the observed earthquakes have not been located with precision. The history of local seismic activity is commonly used as a basis for determining the size and frequency to be expected of local crustal events. Although the historical record of local earthquakes is relatively short (the earliest reported seismic event in the area occurred in 1920), it can serve as a guide for estimating the potential for seismic activity in the area.

Based on fault mapping conducted by the USGS (Personius et al., 2003), the inferred location of the Canby-Mollala Fault is about 5 km east of the site. However, the USGS does not consider the Canby-Mollala Fault to be an active, contributing source in their Probabilistic Seismic Hazard Analysis (PSHA). Based on our review of the USGS deaggregations for the site (U.S. Geological Survey, 2014), the Bolton Fault is the closest crustal fault contributing to the overall seismic hazard at the site. The inferred location of the Bolton Fault is approximately 9 km east of the site, and the fault has a characteristic earthquake magnitude of $M_w = 6.2$. A crustal earthquake of this size would result in a peak horizontal bedrock acceleration of approximately 0.42 g at the site based on an average of the next generation attenuation (NGA) ground-motion relations published by Boore et al. (2014), Campbell and Bozorgnia (2014), and Chiou and Youngs (2014).

Summary of Deterministic Earthquake Parameters

In summary, three distinctly different types of earthquakes affect seismicity in the project area. Deterministic evaluation of the earthquake sources using recently published attenuation ground-motion relations provides estimates of ground response for each individual earthquake type. Unlike probabilistic estimates, these deterministic estimates are not associated with a relative hazard level or probability of occurrence and simply provide an estimate of the ground-motion parameters for each type of fault at a given distance from the site. The basic parameters of each type of earthquake are as follows:

Earthquake Source	Attenuation Relationships for Deterministic Spectra	Magnitude, M_w	Rupture Distance, km	Focal Depth, km	Peak Bedrock Acceleration, g	Average Peak Bedrock Acceleration, g
Subduction Zone	Atkinson and Macias, 2009	9.0	75.0	30	0.18	0.22
	Zhao et al., 2006	9.0	75.0	30	0.23	
	Abrahamson et al., 2015	9.0	75.0	30	0.26	
Subcrustal	Youngs et al., 1997	7.0	63.0	50	0.10	0.15
	Abrahamson et al., 2015	7.0	63.0	50	0.20	
Local Crustal	Campbell and Bozorgnia, 2014	6.2	9.0	NA	0.47	0.42
	Chiou and Youngs, 2014	6.2	9.0	NA	0.36	
	Boore et al. (2014)	6.2	9.0	NA	0.45	

Probabilistic Considerations

The probability of an earthquake of a specific magnitude occurring at a given location is commonly expressed by its return period, i.e., the average length of time between successive occurrences of an earthquake of that size or larger at that location. The return period of a design earthquake is calculated once a project design life and some measure of the acceptable risk that the design earthquake might occur or be exceeded are specified. These expected earthquake recurrences are expressed as a probability of exceedance during a given time period or design life. Historically, building codes have adopted an acceptable risk level by identifying ground-acceleration values that meet or exceed a 10% probability of exceedance in 50 years, which corresponds to an earthquake with an expected recurrence interval of 475 years. Previous versions of the IBC developed response spectra based on ground motions associated with the Maximum Considered Earthquake (MCE), which is generally defined as a probabilistic earthquake with a 2% probability of exceedance in 50 years (return period of about 2,500 years) except where subject to deterministic limitations (Leyendecker and Frankel, 2000).

The recent 2012 IBC develops response spectra using a Risk-Targeted Maximum Considered Earthquake (MCE_R), which is defined as the response spectrum expected to achieve a 1% probability of building collapse within a 50-year period. The design-level response spectrum is calculated as two-thirds of the MCE_R ground motions. Since the MCE_R earthquake ground motions were developed by the USGS to incorporate the targeted 1% in 50 years risk of structural collapse based on a generic structural fragility, they are different than the ground motions associated with the traditional MCE. Although site response is evaluated based on the MCE_R , it should be noted that seismic hazards, such as liquefaction and soil strength loss, are evaluated using the Maximum Considered Earthquake Geometric Mean (MCE_G) peak ground acceleration (PGA), which is more consistent with the traditional MCE.

The 2012 IBC design methodology uses two mapped spectral acceleration parameters, S_s and S_1 , corresponding to periods of 0.2 and 1.0 sec to develop the MCE_R earthquake. The S_s and S_1 parameters for the site located at the approximate latitude and longitude coordinates of 45.3590°N and 122.7726°W are 0.94 and 0.41 g, respectively.

Estimated Site Response

The effect of a specific seismic event on the site is related to the type and quantity of seismic energy delivered to the bedrock beneath the site by the earthquake and the type and thickness of soil overlying the bedrock at the site. A ground-motion hazard analysis was completed to estimate this site-specific behavior in accordance with Section 21.2 of ASCE 7-10. The ground-motion hazard analysis consisted of four

significant components: 1) estimation of bedrock response using recently developed attenuation relationships (deterministic evaluation), 2) estimation of bedrock response using the 2014 USGS-based PSHA (probabilistic evaluation), 3) comparison of the deterministic and probabilistic bedrock-response spectra to determine the controlling spectrum, and 4) development of recommended response spectra for the four hazard levels. The following paragraphs describe the details of the ground-motion hazard analysis.

To estimate the deterministic bedrock-response spectrum, recently developed attenuation relationships were used to evaluate bedrock ground motions at the site. Based on our review of the USGS deaggregations (U.S. Geological Survey, 2014), crustal seismicity and an event on the CSZ represent the largest contributing sources to the seismic hazard at the site. Considering this, we have chosen to estimate the deterministic bedrock response using 84th-percentile ground motions from the following two earthquake scenarios: 1) a Mw 6.2 crustal earthquake at a distance of 9 km from the site and 2) a Mw 9.0 subduction zone earthquake at a distance of 75 km from the site. The same attenuation relationships outlined in the **Summary of Deterministic Earthquake Parameters** section were used to evaluate the crustal and subduction earthquake responses. The resulting deterministic bedrock-response spectra are shown on Figure 6B and indicate crustal seismicity controls the hazard at the site. The deterministic MCE_R bedrock spectrum is taken as the larger of the 84th-percentile ground motions and the deterministic lower limit. The probabilistic bedrock-response spectrum was acquired through the use of the USGS Interactive Deaggregation (U.S. Geological Survey, 2014). The deaggregation was evaluated for a 2% in 50 years probability over a period range of PGA to 5 sec. In accordance with Section 21.2 of ASCE 7-10, the site-specific bedrock MCE_R response spectrum is taken as the lesser of the probabilistic and deterministic MCE_R bedrock motions. Figure 6B demonstrates the probabilistic bedrock spectrum is the lesser of the spectra.

The site is classified as Site Class C, or a very dense soil and soft rock site, based on the average V_{s30} of 2,000 ft/sec in accordance with Section 20.3 of ASCE 7-10. Corresponding short- and long-period adjustment factors F_a and F_v of 1.02 and 1.39, respectively, were used to develop the probabilistic Site Class C MCE_R response spectrum. We recommend using the Site Class C MCE_R and design response spectra shown on Figure 7B for design of the new additions.

Seismic Hazards

Based on the depth to groundwater at the site, it is our opinion the risk of liquefaction and/or cyclic softening at the site is low. Based on site topography, the risk of earthquake-induced slope instability is low. The risk of damage by tsunami and/or seiche at the site is absent. The inferred location of the Canby-Mollala Fault is about 5 km east of the site (Personius et al., 2003); however, the USGS does not consider the Canby-Mollala Fault to be an active, contributing source in their PSHA. The USGS considers the Bolton Fault, located about 9 km east of the site, to be the closest crustal fault source contributing to the overall seismic hazard at the site. Unless occurring on a previously unmapped or unknown fault, the risk of fault rupture at the site is low.

CONCLUSIONS

The 2012 IBC design methodology uses two spectral response parameters, S_s and S_1 , corresponding to periods of 0.2 and 1.0 sec to develop the MCE_R response spectrum. The S_s and S_1 parameters for the site are 0.94 and 0.41 g, respectively. The results of the ground-motion hazard analysis indicate the 2012 IBC Site Class C spectrum provides an appropriate estimate of the spectral accelerations at the site. We

recommend use of the Site Class C design spectrum shown on Figure 7B for design of the new structures at the site.

References

- Abrahamson, N.A., Gregor, N., and Addo, K., 2015, BC hydro ground motion prediction equations for subduction earthquakes, *Earthquake Spectra* In-Press.
- Adams, J., 1990, Paleoseismicity of the Cascadia subduction zone: Evidence from turbidites off the Oregon-Washington margin: *Tectonics*, vol. 9, no. 4, pp. 569-583.
- Atkinson, G. M., and Macias, M., 2009, Predicted ground motions for great interface earthquakes in the Cascadia Subduction Zone: *Bulletin of the Seismological Society of America*, vol. 99, no. 3, pp. 1552-1578.
- Atwater, B.F., and Hemphill-Haley, E., 1997, Recurrence intervals for great earthquakes of the past 3,500 years at northeastern Willapa Bay, Washington: U.S. Geological Survey Professional Paper 1576, p. 108.
- Atwater, B.F., Nelson, A.R., Clague, J.J., Carver, G.A., Yamaguchi, D.K., Bobrowsky, P.T., Bourgeois, J., Darienzo, M.E., Grant, W.C., Hemphill-Haley, E., Kelsey, H.M., Jacoby, G.C., Nishenko, S.P., Palmer, S.P., Peterson, C.D., and Reinhart, M.A., 1995, Summary of coastal geologic evidence for past great earthquakes at the Cascadia subduction zone: *Earthquake Spectra*.
- Boore, D.M., Stewart, J.P., Seyhan, E., and Atkinson, G.M., 2014, NGA-West2 equations for predicting PGA, PGV, and 5% damped PSA for shallow crustal earthquakes: *Earthquake Spectra*, August 2014, vol. 30, no. 3, pp. 1057-1085.
- Campbell, K. W., and Bozorgnia, Y., 2014, NGA-West2 ground motion model for average horizontal components of PGA, PGV, and 5% damped linear acceleration response spectra: Submitted to *Earthquake Spectra*.
- Chiou, B. S. J., and Youngs, R. R., 2014, Update of the Chiou and Youngs NGA model for the average horizontal component of peak ground motion and response spectra: Submitted to *Earthquake Spectra*.
- Clague, J.J., 1997, Evidence for large earthquakes at the Cascadia subduction zone: *Reviews of Geophysics*, vol. 35, no. 4, pp. 439-460.
- Clague, J.J., Atwater, B.F., Wang, K., Wang, Y., and Wong, I., 2000, Penrose conference report—Great Cascadia earthquake tricentennial: *GSA Today*, vol. 10, no. 11, pp. 14-15.
- Fluck, P., Hyndman, R.D., and Wang, K., 1997, Three-dimensional dislocation model for great earthquakes of the Cascadia subduction zone: *Journal of Geophysical Research*, vol. 102, no. B9, pp. 20539-20550.
- Goldfinger, C., 1994, Active deformation of the Cascadia Forearc—Implications for great earthquake potential in Oregon and Washington, Oregon State University, unpublished dissertation.
- Goldfinger, C., Nelson, C.H., and Johnson, J.E., 2003, Holocene earthquake records from the Cascadia subduction zone and northern San Andreas fault based on precise dating of offshore turbidites: *Annual Review of Earth and Planetary Sciences* 31, pp. 555-577.
- Guffanti, M., and Weaver, C.S., 1988, Distribution of Late Cenozoic volcanic vents in the Cascade Range—Volcanic arc segmentation and regional tectonic considerations: *Journal of Geophysical Research*, vol. 93, no. B6, pp. 6513-6529.
- Hughes, J.M., and Carr, M.J., 1980, Segmentation of the Cascade volcanic chain: *Geology*, vol. 8, pp. 15-17.
- Hyndman, R.D., and Wang, K., 1995, The rupture zone of Cascadia great earthquakes from current deformation and the thermal regime: *Journal of Geophysical Research*, vol. 100, no. B11, pp. 22133-22154.
- Kelsey, H.M., and Bockheim, J.G., 1994, Coastal landscape evolution as a function of eustasy and surface uplift rate, Cascadia margin, southern Oregon: *Geological Society of America Bulletin*, vol. 106, pp. 840-854.
- Kelsey, H.M., Witter, R.C., and Hemphill-Haley, E., 2002, Pl.-boundary earthquakes and tsunamis of the past 5500 yr, Sixes River estuary, southern Oregon: *Geological Society of America Bulletin*, vol. 114, no. 3, pp. 298-314.
- Kelsey, H.M., Nelson, A.R., Hemphill-Haley, E., and Witter, R.C., 2005, Tsunami history of an Oregon coastal lake reveals a 4600 yr record of great earthquakes on the Cascadia subduction zone: *GSA Bulletin*, vol. 117, pp. 1009-1032.
- Leyendecker, E.V., and Frankel, A.D., 2000, Development of maximum considered earthquake ground motion maps: *Earthquake Spectra*, vol. 16, no. 1.
- Mitchell, C.E., Vincent, P., Weldon, R.J. III, and Richards, M.A., 1994, Present-day vertical deformation of the Cascadia margin, Pacific Northwest, United States: *Journal of Geophysical Research*, vol. 99, no. B6, pp. 12257-12277.
- Nelson, A.R., and Personius, S.F., 1996, Great-earthquake potential in Oregon and Washington—An overview of recent coastal geologic studies and their bearing on segmentation of Holocene ruptures, central Cascadia subduction zone, in Rogers,

- A.M., Walsh, T.J., Kockelman, W.J., and Priest, G.R., eds., *Assessing earthquake hazards and reducing risk in the Pacific Northwest*: U.S. Geological Survey Professional Paper 1560, vol. 1, pp. 91-114.
- O'Connor, J.E., Sarna-Wojcick, A., Woznikak, K.C., Polette, D.J., and Fleck, R.J., 2001, Origin, extent, and thickness of quaternary geologic units in the Willamette Valle, Oregon: U.S. Geological Survey Professional Paper 1620.
- Personius, S.F., 1995, Late Quaternary stream incision and uplift in the forearc of the Cascadia subduction zone, western Oregon: *Journal of Geophysical Research*, vol. 100, no. B10, pp. 20193-20210.
- Personius, S. F., Dart, R. L., Bradley, Lee-Ann, and Haller, K. M., 2003, Map and data for Quaternary faults and folds in Oregon: U.S. Geological Survey Open-File Report 03-095.
- Petersen, M. D., Frankel, A. D., Hamsen, S. C., Mueller, C. S., Haller, K. M., Wheeler, R. L., Wesson, R. L., Zeng, Y., Boyd, O. S., Perkins, D. M., Luco, N., Field, E. H., Wills, C. J., and Rukstales, K. S., 2008, Documentation for the 2008 update of the United States National Seismic Hazard Maps: U.S. Geological Survey Open-File Report 2008-1128.
- Satake, K., Shimazaki, K., Tsuji, Y., and Ueda, K., 1996, Time and size of a giant earthquake in Cascadia inferred from Japanese tsunami records of January 1700: *Nature*, vol.379, pp. 246-249.
- Savage, J.C., Svarc, J.L., Prescott, W.H., and Murray, M.H., 2000, Deformation across the forearc of the Cascadia subduction zone at Cape Blanco, Oregon: *Journal of Geophysical Research*, vol. 105, no. B2, pp. 3095-3102.
- U.S. Geological Survey, 2014, Unified hazard tool lookup by latitude, longitude, accessed 04/11/17 from USGS website: <https://earthquake.usgs.gov/hazards/interactive/>.
- Wang, Y., He, J., Dragert, H., and James, T.S., 2001, Three-dimensional viscoelastic interseismic deformation model for the Cascadia subduction zone: *Earth, Planets and Space*, vol. 53, pp. 295-306.
- Weaver, C.S., and Shedlock, K.M., 1989, Potential subduction, probable intraplate and known crustal earthquake source areas in the Cascadia Subduction Zone: U.S. Geological Survey Open-File Report 89-465, pp. 11-26.
- Weaver, C.S., and Michaelson, C.A., 1985, Seismicity and volcanism in the Pacific Northwest—Evidence for the segmentation of the Juan de Fuca Pl.: *Geophysical Research Letters*, vol. 12, no. 4, pp. 215-218.
- Witter, R.C., 1999, Late Holocene Paleoseismicity, tsunamis and relative sea-level changes along the south-central Cascadia subduction zone, southern Oregon: University of Oregon, unpublished PhD dissertation, pp. 178.
- Witter, R.C., Kelsey, H.M., and Hemphill-Haley, E., 2003, Great Cascadia earthquakes and tsunamis of the past 6700 years, Coquille River estuary, southern coastal Oregon: *Geological Society of America Bulletin* 115, pp.1289-1306.
- Wong, I., 2005, Low potential for large intraslab earthquakes in the central Cascadia Subduction Zone: *Bulletin of the Seismological Society of America*, vol. 95, no. 5.
- Yongs, R.R., Chiou, S.J., Silva, W.J., and Humphrey, J.R., 1997, Strong ground motion attenuation relationships for subduction zone earthquakes: *Seismological Research Letters*, vol. 68, no. 1, pp. 58-73.
- Zhao, J.X., Zhang, J., Asano, A., Ohno, Y., Oouchi, T., Takahashi, T., Ogawa, H., Irikura, K., Thio, H., Somerville, P., Fukushima, Y., and Fukushima, Y., 2006, Attenuation relations of strong ground motion in Japan using site classification based on predominant period: *Bulletin of the Seismological Society of America*, vol. 96, pp. 898-913.

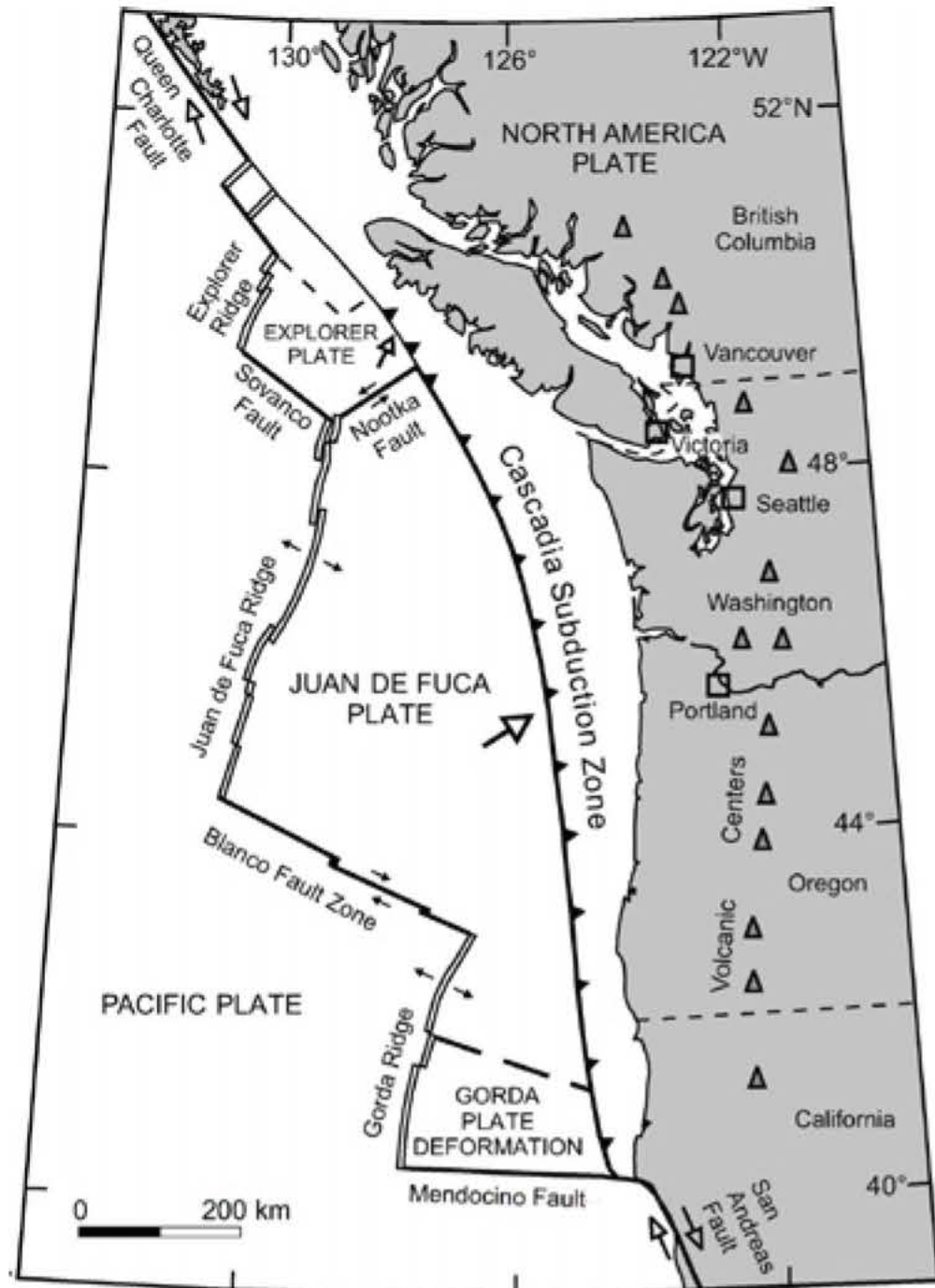

A) TECTONIC MAP OF PACIFIC NORTHWEST, SHOWING ORIENTATION AND EXTENT OF CASCADIA SUBDUCTION ZONE (MODIFIED FROM DRAGERT AND OTHERS, 1994)

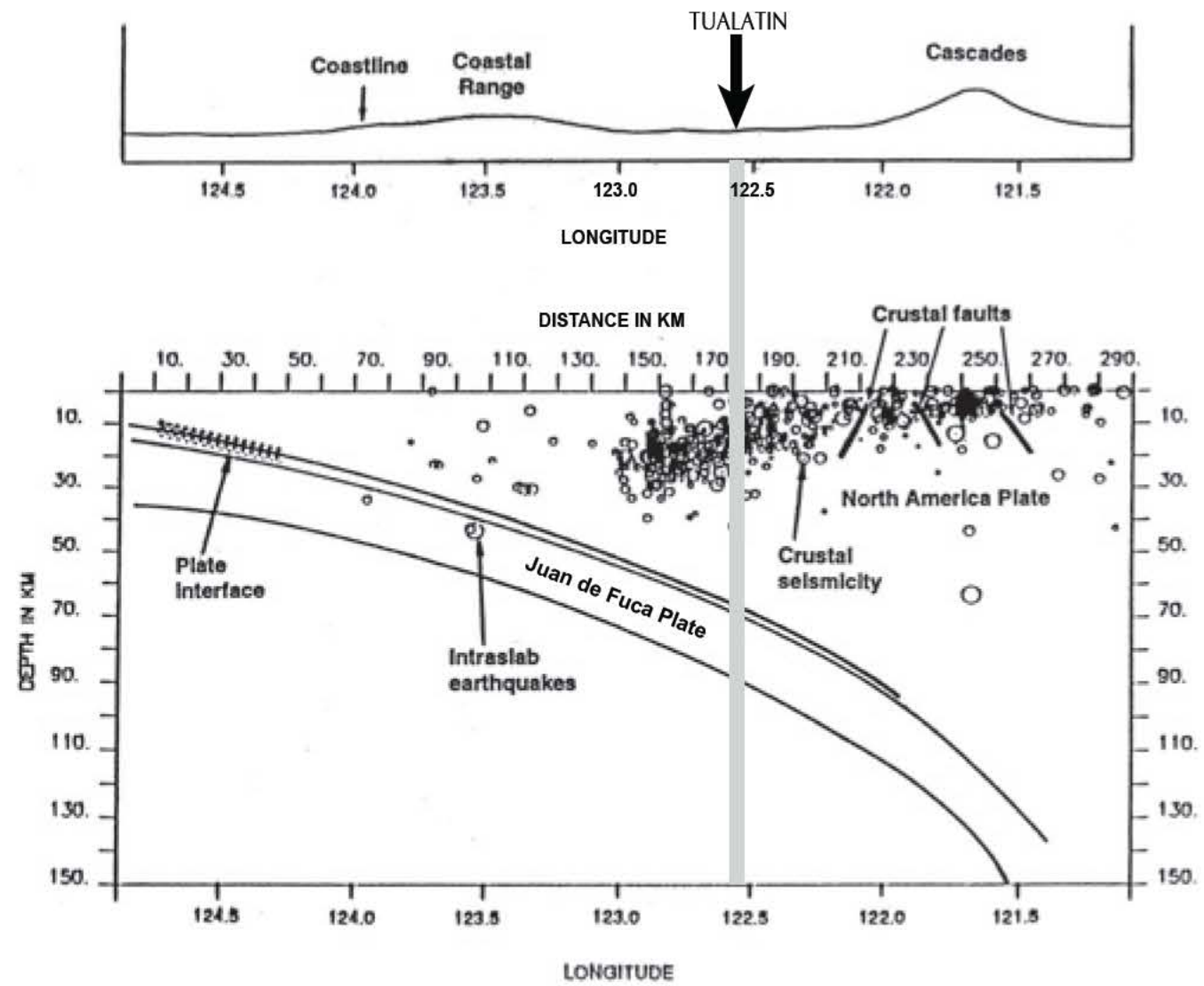

B) EAST-WEST CROSS-SECTION THROUGH WESTERN OREGON AT THE LATITUDE OF PORTLAND, SHOWING THE SEISMIC SOURCES CONSIDERED IN THE SITE-SPECIFIC SEISMIC HAZARD STUDY (MODIFIED FROM GEOMATRIX, 1995)



TECTONIC SETTING SUMMARY

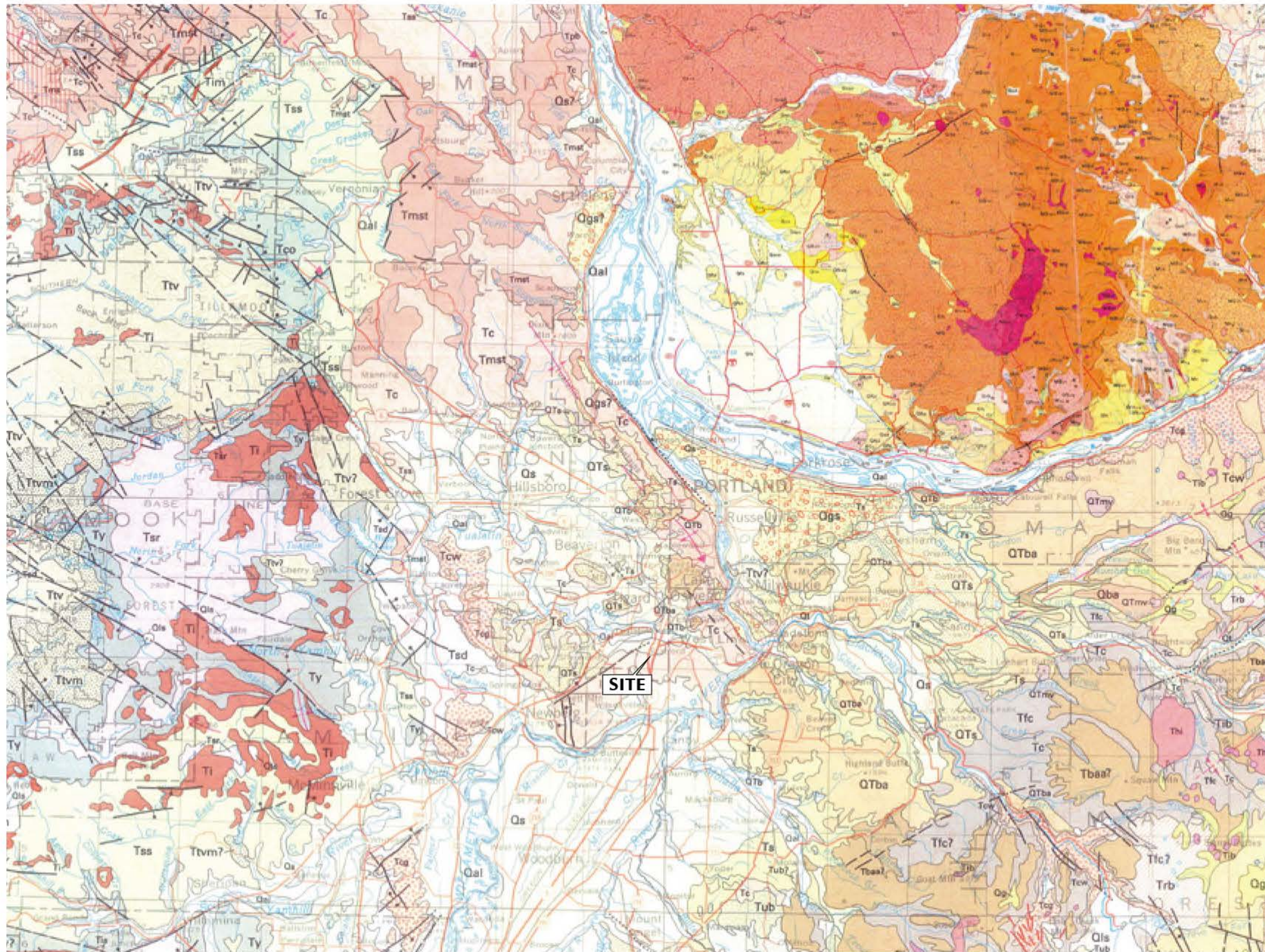

- Contact — Approximately located
- ?— Fault — Dashed where inferred; dotted where concealed; queried where doubtful; ball and bar on downthrown side
- ▲?▲▲ Thrust fault — Dashed where inferred; dotted where concealed; queried where doubtful; sawteeth on upper plate
- ⁷ Strike and dip of bed

FROM:
 WALSH, T.J., KORSEK, M.A., PHILLIPS, W.M., LOGAN, R.L., AND SCHASSE, H.W.,
 1987, GEOLOGIC MAP OF WASHINGTON-SOUTHWEST QUADRANT; 1:250,000;
 WASHINGTON DIVISION OF GEOLOGY AND EARTH RESOURCES, 6M-34
 WALKER, G.W., AND MACLEOD, N.S., 1991, GEOLOGIC MAP OF OREGON; U.S.
 GEOLOGICAL SURVEY

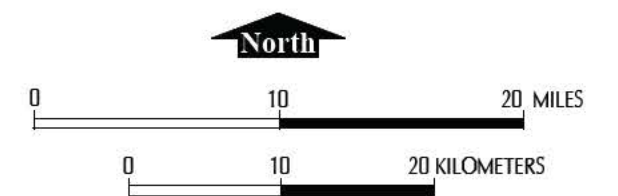

REGIONAL GEOLOGIC MAP

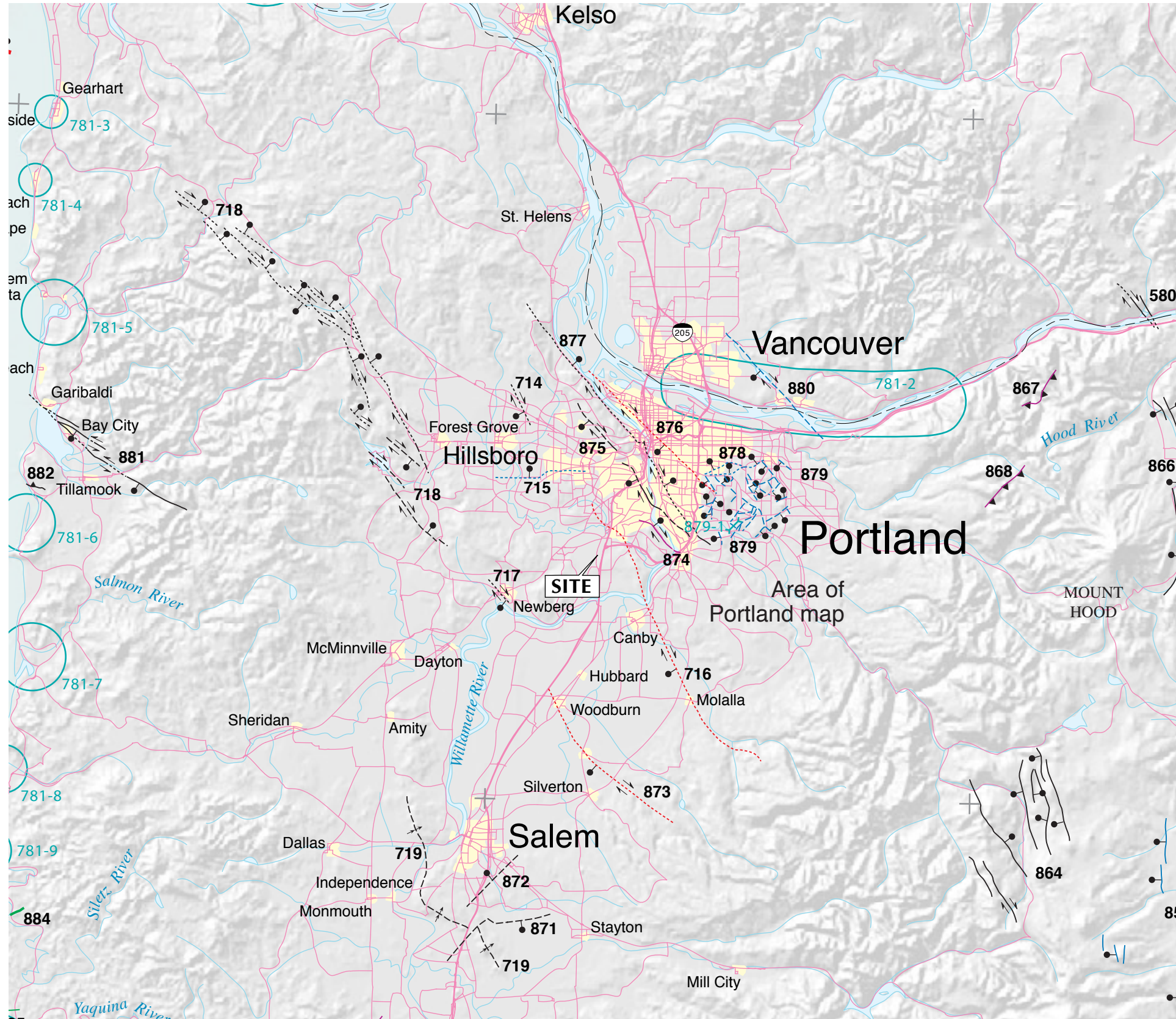

MAP EXPLANATION

- TIME OF MOST RECENT SURFACE RUPTURE**
 - Red line: Holocene (<10,000 years) or post last glaciation (<15,000 years; 15 ka); no historic ruptures in Oregon to date
 - Green line: Late Quaternary (<130,000; post penultimate glaciation)
 - Blue line: Late and middle Quaternary (<750,000 years; 750 ka)
 - Black line: Quaternary, undifferentiated (<1,600,000 years; <1.6 Ma)
 - Purple line: Class B structure (age or origin uncertain)
- SLIP RATE**
 - Thick black line: >5 mm/year
 - Medium black line: 1.0-5.0 mm/year
 - Thin black line: 0.2-1.0 mm/year
 - Dotted line: <0.2 mm/year
- TRACE**
 - Solid line: Mostly continuous at map scale
 - Dashed line: Mostly discontinuous at map scale
 - Dotted line: Inferred or concealed
- STRUCTURE TYPE AND RELATED FEATURES**
 - Vertical line with tick: Normal or high-angle reverse fault
 - Horizontal line with arrow: Strike-slip fault
 - Triangle: Thrust fault
 - Circle with cross: Anticlinal fold
 - Circle with vertical line: Synclinal fold
 - Circle with horizontal line: Monoclinical fold
 - Arrow: Plunge direction of fold
 - Triangle: Fault section marker
- DETAILED STUDY SITES**
 - Blue circle: Trench site (731-2)
 - Red circle: Subduction zone study site (781-2)
- CULTURAL AND GEOGRAPHIC FEATURES**
 - Red line: Divided highway
 - Blue line: Primary or secondary road
 - Blue line: Permanent river or stream
 - Blue line: Intermittent river or stream
 - Blue circle: Permanent or intermittent lake

FAULT NUMBER	NAME OF STRUCTURE
714	HELVETIA FAULT
715	BEAVERTON FAULT
716	CANBY-MOLALLA FAULT
717	NEWBERG FAULT
718	GALES CREEK FAULT ZONE
719	SALEM-EOLA HILLS HOMOCLINE
864	CLACKAMAS RIVER FAULT ZONE
867	EAGLE CREEK THRUST FAULT
868	BULL RUN THRUST FAULT
872	WALDO HILLS FAULT
873	MOUNT ANGEL FAULT
874	BOLTON FAULT
875	OATFIELD FAULT
876	EAST BANK FAULT
877	PORTLAND HILLS FAULT
878	GRANT BUTTE FAULT
879	DAMASCUS-TICKLE CREEK FAULT ZONE
880	LACAMAS LAKE FAULT
881	TILLAMOOK BAY FAULT ZONE

FROM: PERSONIUS, S.F., AND OTHERS, 2003, MAP OF QUATERNARY FAULTS AND FOLDS IN OREGON, USGS OPEN FILE REPORT OFR-03-095.

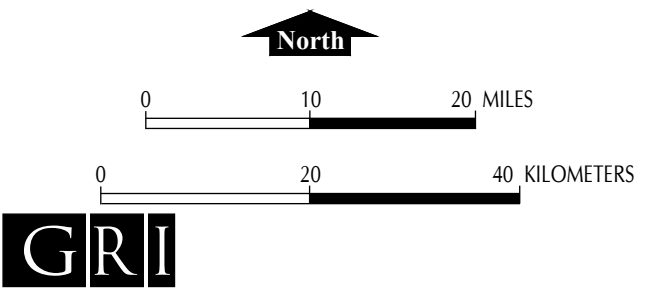

LOCAL FAULT MAP

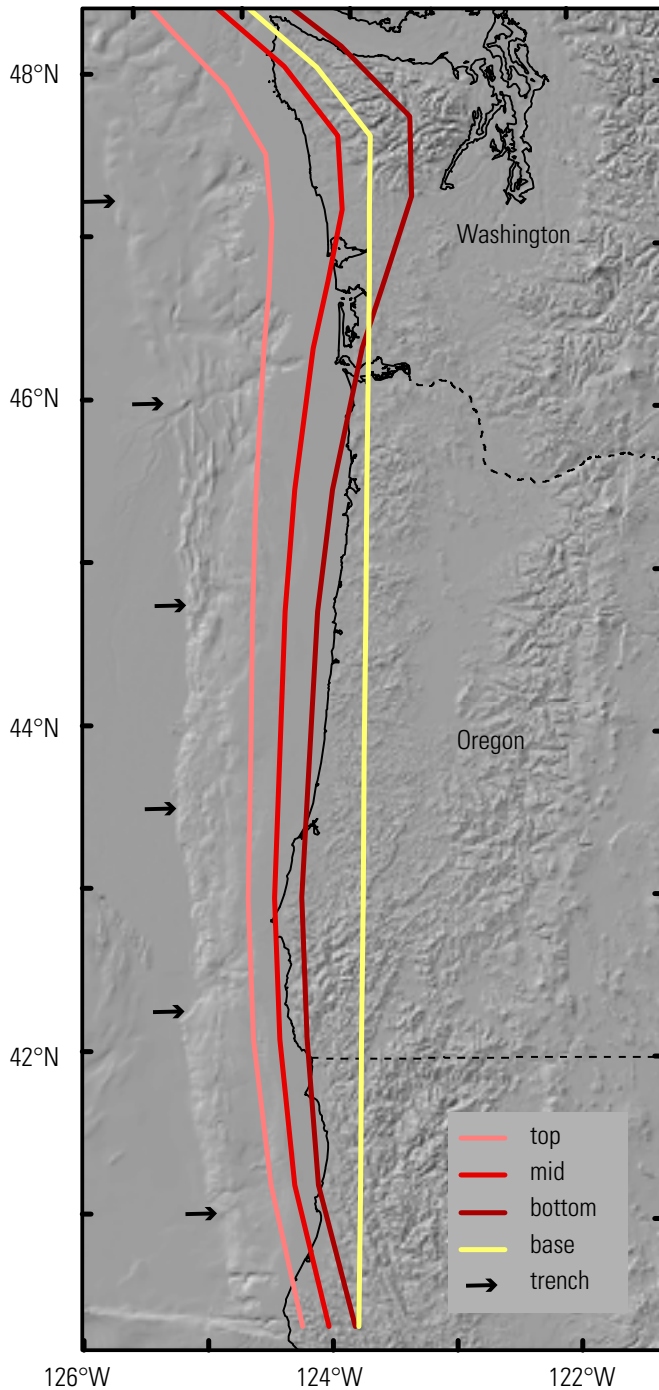

FIGURE 21. LOCATION OF THE EASTERN EDGE OF EARTHQUAKE RUPTURE ZONES ON THE CASCADIA SUBDUCTION ZONE FOR THE VARIOUS MODELS USED IN THIS STUDY RELATIVE TO THE SURFICIAL EXPRESSION OF THE TRENCH: TOP, BASE OF THE ELASTIC ZONE; MID, MIDPOINT OF THE TRANSITION ZONE; BOTTOM, BASE OF THE TRANSITION ZONES; BASE, BASE OF THE MODEL THAT ASSUMES RUPTURES EXTEND TO ABOUT 30-KILOMETERS DEPTH. FIGURE PROVIDED BY RAY WELDON.

FROM: PETERSEN, MD, FRANKEL, AD, HARMSSEN, SC, AND OTHERS, 2008, DOCUMENTATION FOR THE 2008 UPDATE OF THE UNITED STATES NATIONAL SEISMIC HAZARD MAPS: US GEOLOGICAL SURVEY, OPEN FILE REPORT 2008-1128



ASSUMED RUPTURE LOCATIONS (CASCADIA SUBDUCTION ZONE)

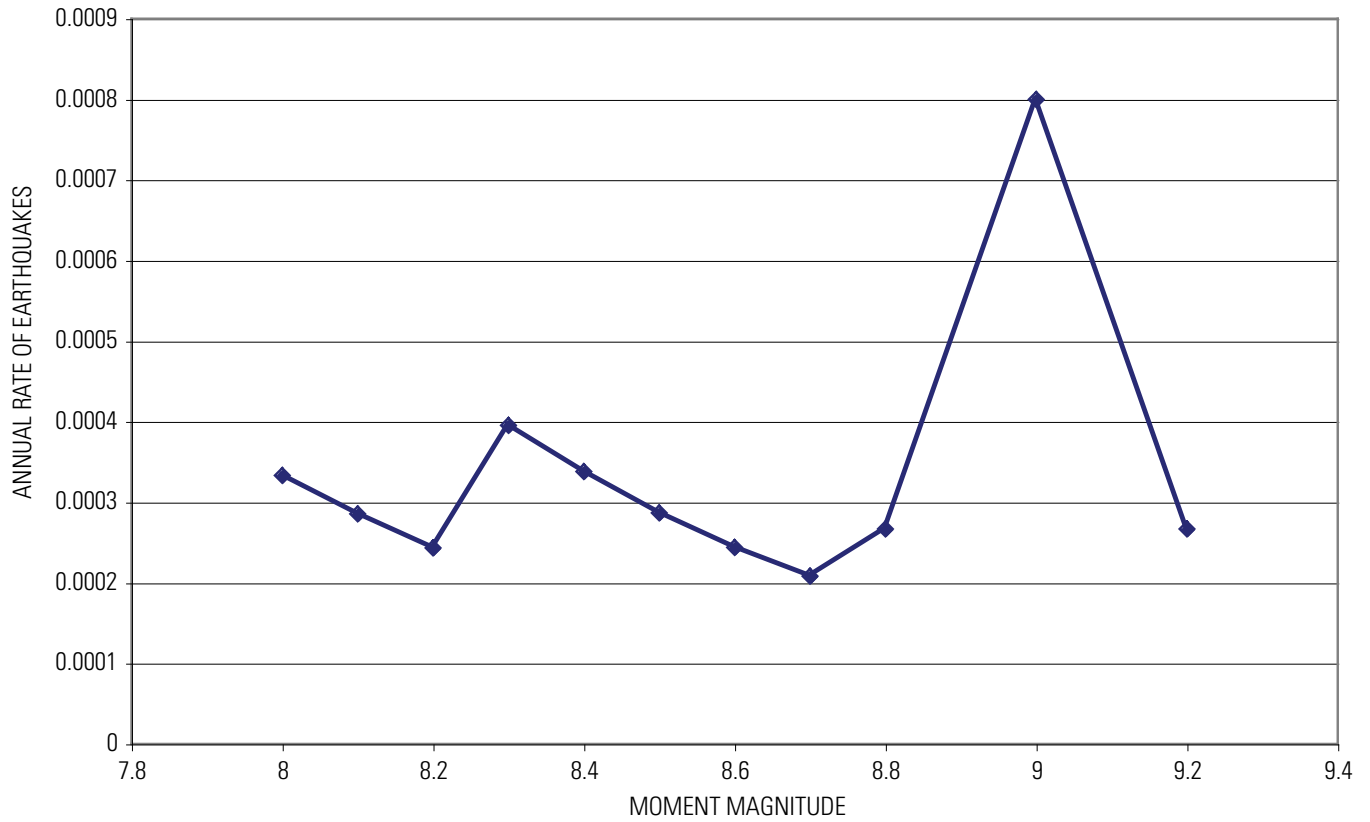
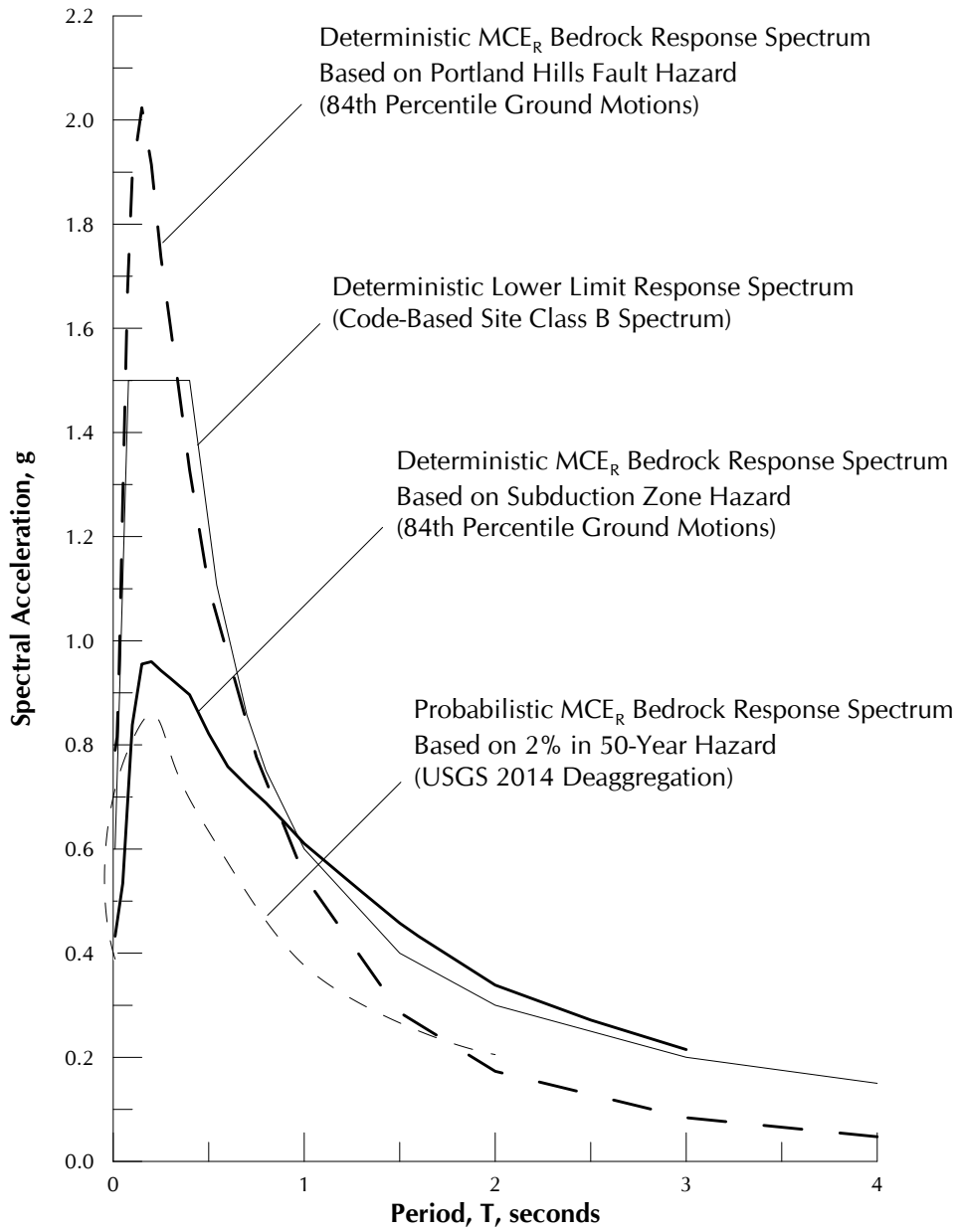

Figure 22. Magnitude-frequency distribution of the Cascadia subduction zone.

FROM: PETERSEN, M, FRANKEL, A, HARMSSEN, S, AND OTHERS, 2008, DOCUMENTATION FOR THE 2008 UPDATE OF THE UNITED STATES NATIONAL SEISMIC HAZARD MAPS: US GEOLOGICAL SURVEY, OPEN FILE REPORT 2008-1128



ASSUMED
MAGNITUDE-FREQUENCY DISTRIBUTION
(CASCADIA SUBDUCTION ZONE)



DETERMINISTIC VS. PROBABILISTIC
BEDROCK RESPONSE SPECTRA
(5% DAMPING)

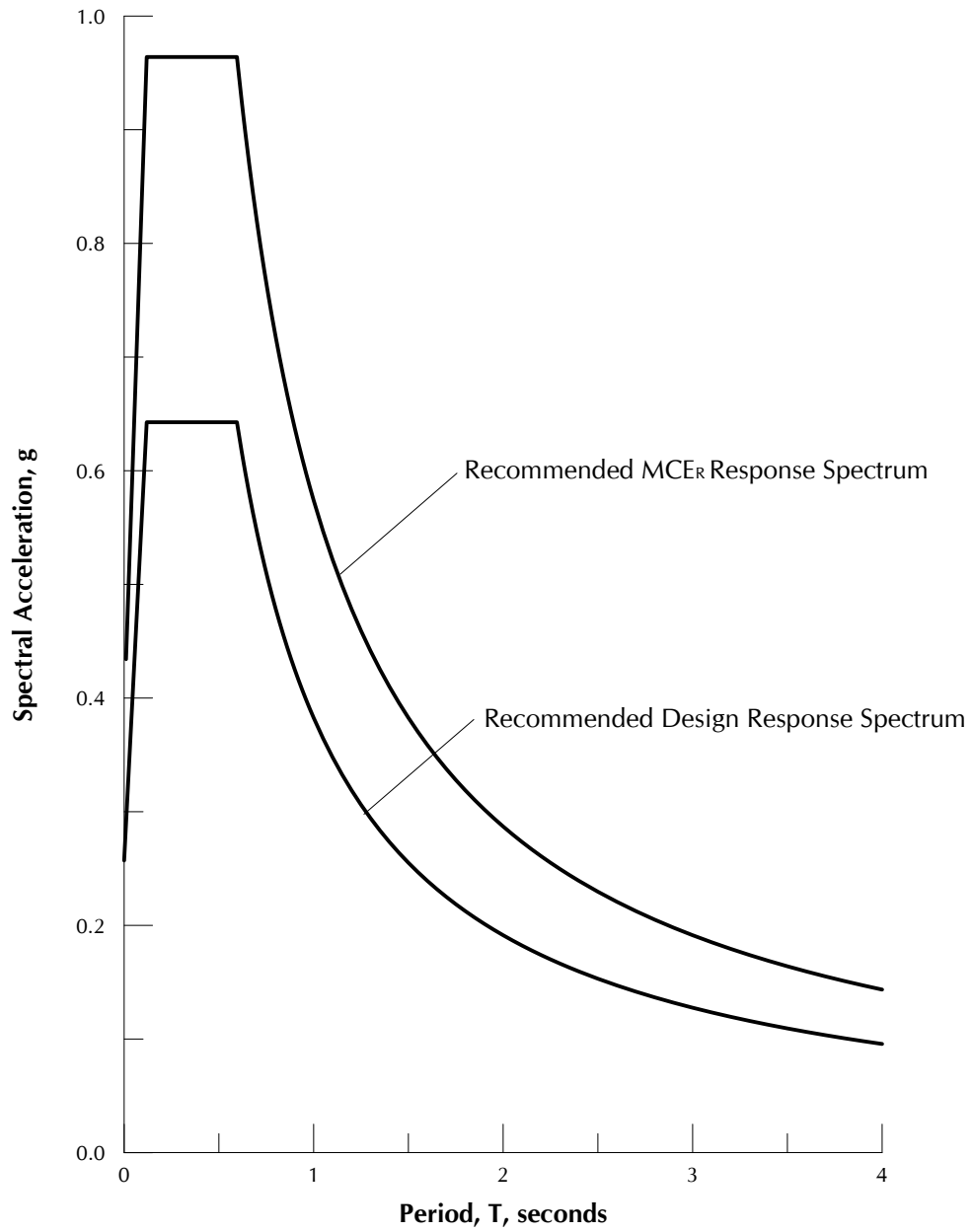

DESIGN AND RECOMMENDED
RESPONSE SPECTRA
(5% DAMPING)

October 24, 2017

Project #:21156

Tony Doran
City of Tualatin
18880 SW Martinazzi Avenue
Tualatin, OR 97062

RE: Tualatin High School Expansion – Traffic Impact Analysis

Dear Tony,

This letter presents the results of Kittelson & Associates Inc.'s transportation assessment of the proposed expansion of Tualatin High School in Tualatin, Oregon. This study concludes that the proposed school project will have no measurable impact at the existing school driveways off of SW Boones Ferry Road because 1) no increase in current student enrollment capacity is accommodated by the proposed changes and 2) no changes to the site access, circulation, or parking are proposed. Further, because the existing school driveways operate in accordance with City standards, no capacity-based transportation mitigation measures are needed to support the proposed project. Additional details of the study methodology and findings are provided herein.

INTRODUCTION

Figure 1 illustrates the vicinity of Tualatin High School which is located at 22300 SW Boones Ferry Road. Built in 1994, Tualatin High School was originally sized to accommodate 1,600 – 1,800 students. Today and for the foreseeable future, approximately 2,000 students are/will be enrolled. From a building perspective, the current school facilities are undersized and underserved in comparison to the modern standards set for a 2,000-student high school. To address this issue, the proposed expansion will include the creation of a new focal entry point and affiliated relocation of administrative offices, expansion of the existing Commons, expansion of the Career Technical Education spaces, and expansion to the fitness and locker rooms. Figure 2 illustrates the proposed site plan for the expanded school building. As indicated by the figure, all building expansions will occur on the existing school grounds and no modifications to the parking areas, circulation roadways, or campus access driveways are proposed.

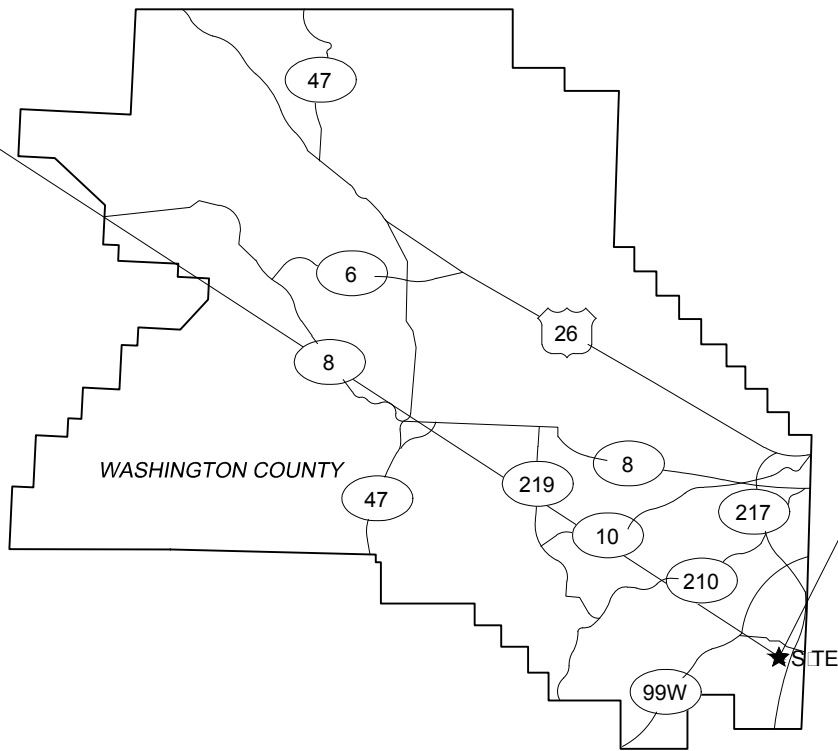
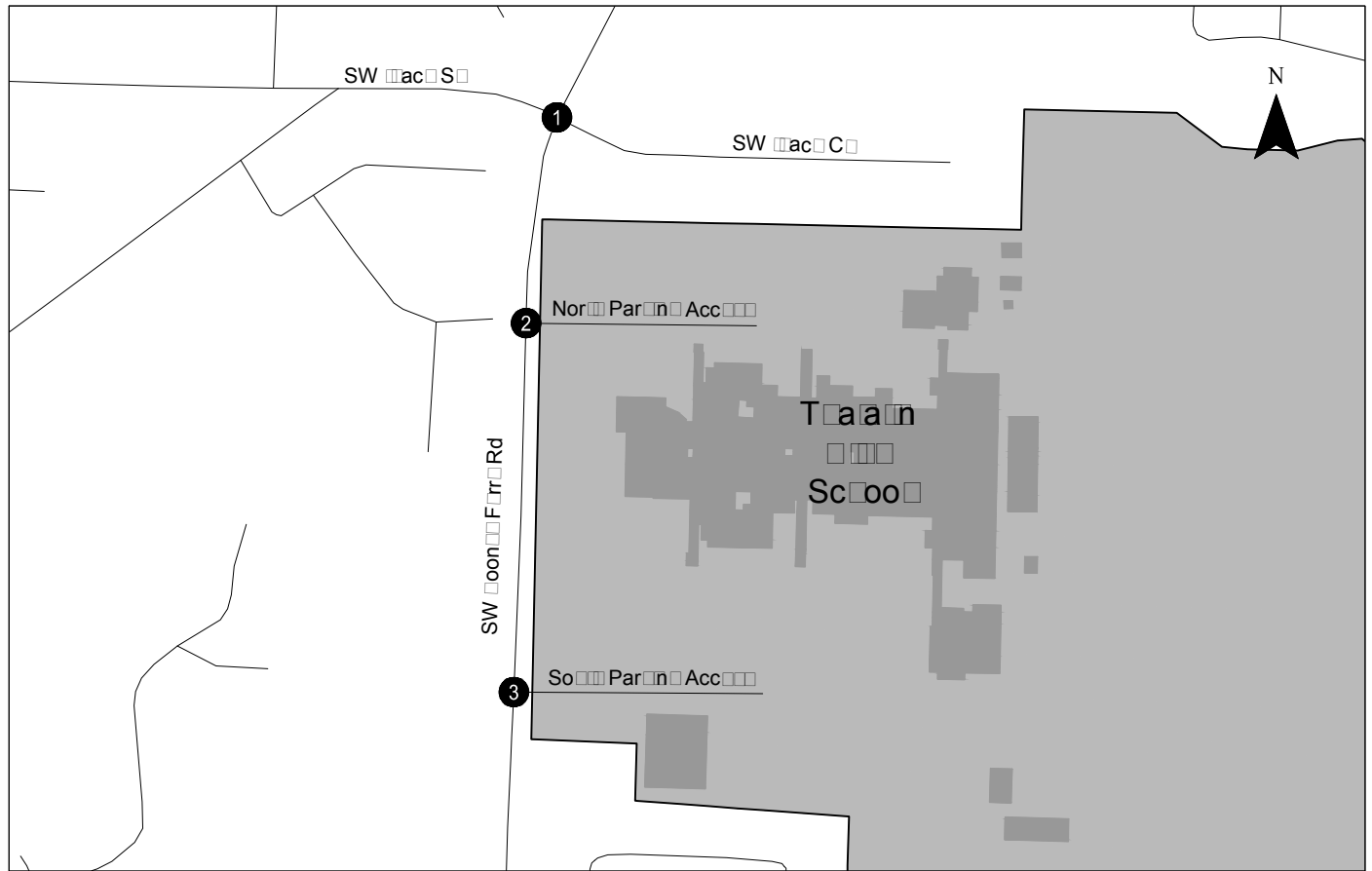

● - Site location

Site Vicinity Map
Tualatin, Oregon

Figure
1

C:\Users\ngross\appdata\local\temp\AcPublish_10468\21156_Figure_Tualatin_High.dwg Oct 19, 2017 - 10:37am - ngross Layout Tab: Site Vicinity Map

SCOPE OF THE REPORT

This report identifies the transportation-related impacts associated with the proposed Tualatin High School expansion. In order to quantify the existing school trip profile, weekday AM, School PM, and PM peak period traffic counts were conducted at the two site access driveways off of SW Boones Ferry Road and at the SW Boones Ferry Road/SW Ibach Street intersection.

This report evaluates the following transportation issues:

- Existing land use and transportation system conditions within the site vicinity during the weekday AM and School PM peak periods;
- A review of any anticipated transportation impacts associated with the proposed school expansion; and
- Conclusions and recommendations.

EXISTING CONDITIONS

This section summarizes the existing characteristics of the transportation system and adjacent land uses in the vicinity of the school campus.

Site Conditions and Adjacent Land Uses



Tualatin High School is located in an established residential neighborhood in the southern portion of the City of Tualatin. The campus is bordered by SW Boones Ferry Road to the west and existing single family residential neighborhoods to the north, east, and south.

Vehicular and bus access to the school campus is currently provided by two full access driveways located off of SW Boones Ferry Road. The northern driveway primarily serves staff and visitors while the southern driveway primarily serves buses and student parking. Due to its proximity to the auditorium, sports fields, and the Tigard-Tualatin Aquatic District Swim Center, the southerly driveway also accommodates the majority of the after-school/weekend spectator and visitor traffic.

Transportation Facilities

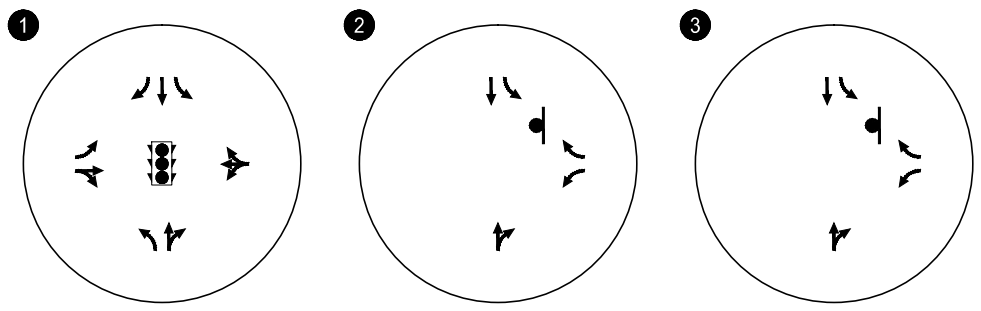
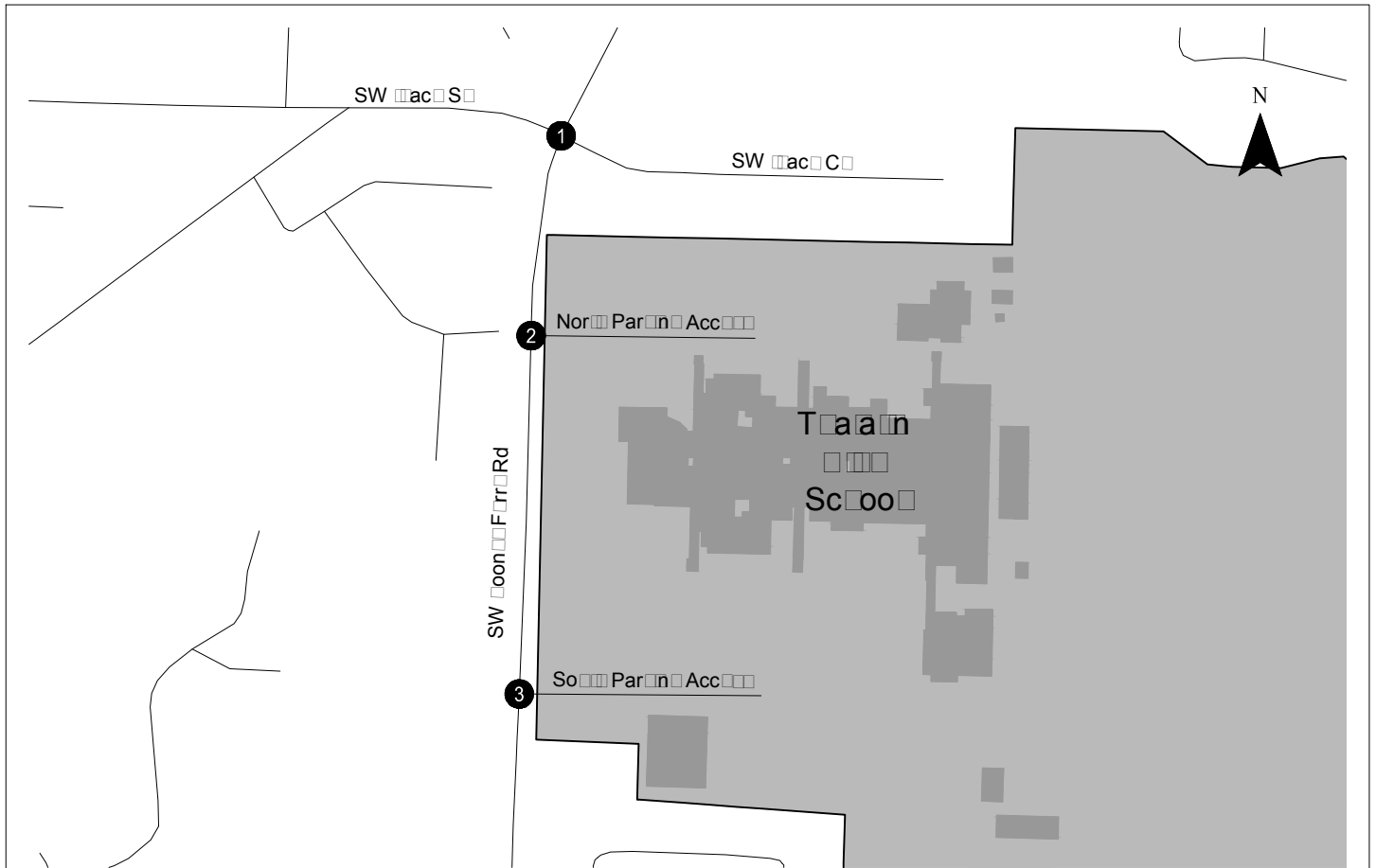
Table 1 identifies the characteristics of key roadways located within the vicinity of the school campus. **Error! Reference source not found.** identifies the existing lane configurations and traffic control devices at the school driveways and the nearby SW Boones Ferry Road/SW Ibach Street intersection.



-  - STOP SIGN
-  - TRAFFIC SIGNAL

Existing Lane Configurations
& Traffic Control Devices
Tualatin, Oregon

Figure
3

C:\Users\jgross\appdata\local\temp\AcPublish_10468\21156_Figure_Tualatin_High.dwg Oct 19, 2017 - 10:38am - ngross - LayoutTab: ELC & TCD

Table 1 – Existing Transportation Facilities

Roadway	Classification ¹	Motor Vehicle Travel Lanes	Posted Speed (mph)	Sidewalks	Striped Bicycle Lanes	On-Street Parking
SW Boones Ferry Road	Major Arterial	3-lanes	35	Yes ²	Yes	No
SW Ibach Street	Major Collector	2-lanes	35	Yes	Yes	No

Notes:

¹ Source: City of Tualatin Transportation System Plan (TSP).

² There is an approximately 200 foot long gap in the sidewalk along the west side of SW Boones Ferry Road south of the south high school driveway (off-site from the school campus).

Bicycle/Pedestrian Facilities

As noted in 1, sidewalks and bicycle lanes are provided along SW Boones Ferry Road and SW Ibach Street providing both local and regional bicycle/pedestrian access to the school campus. In addition to this infrastructure, the campus connects to the adjacent residential neighborhoods via a multi-use pathway. This pathway provides connections to SW Iowa Drive to the south, SW Martinazzi Avenue to the east, and Byrom Elementary School to the north.

Transit Service

Local transit service is provided by TriMet within the general site vicinity. TriMet Line 96 provides frequent service along SW Boones Ferry Road to Portland City Center. Service is provided Monday through Friday from 5:00 AM to 9:00 PM on roughly 30 minute headways. The closest bus stop is located along SW Boones Ferry Road at the SW Boones Ferry Road/SW Ibach Street intersection approximately 300 feet north of the high school’s North Parking Access.

Existing Operations

Manual turning movement counts were collected at the SW Boones Ferry Road/SW Ibach Street intersection and the two site driveways in April 2017 when local schools were in session. Traffic counts were collected during the morning (7:00 to 9:00 AM) and School PM (2:00 to 4:00 PM) peak time periods. *Appendix “A” contains the traffic count worksheets.* Figure and Table 2 summarize the intersection operational analyses during the two school peak hours. As shown in Table 2, all intersections operate at acceptable levels of service during both peak hours per City standards. *Appendix “B” contains the 2017 existing conditions operational worksheets.*

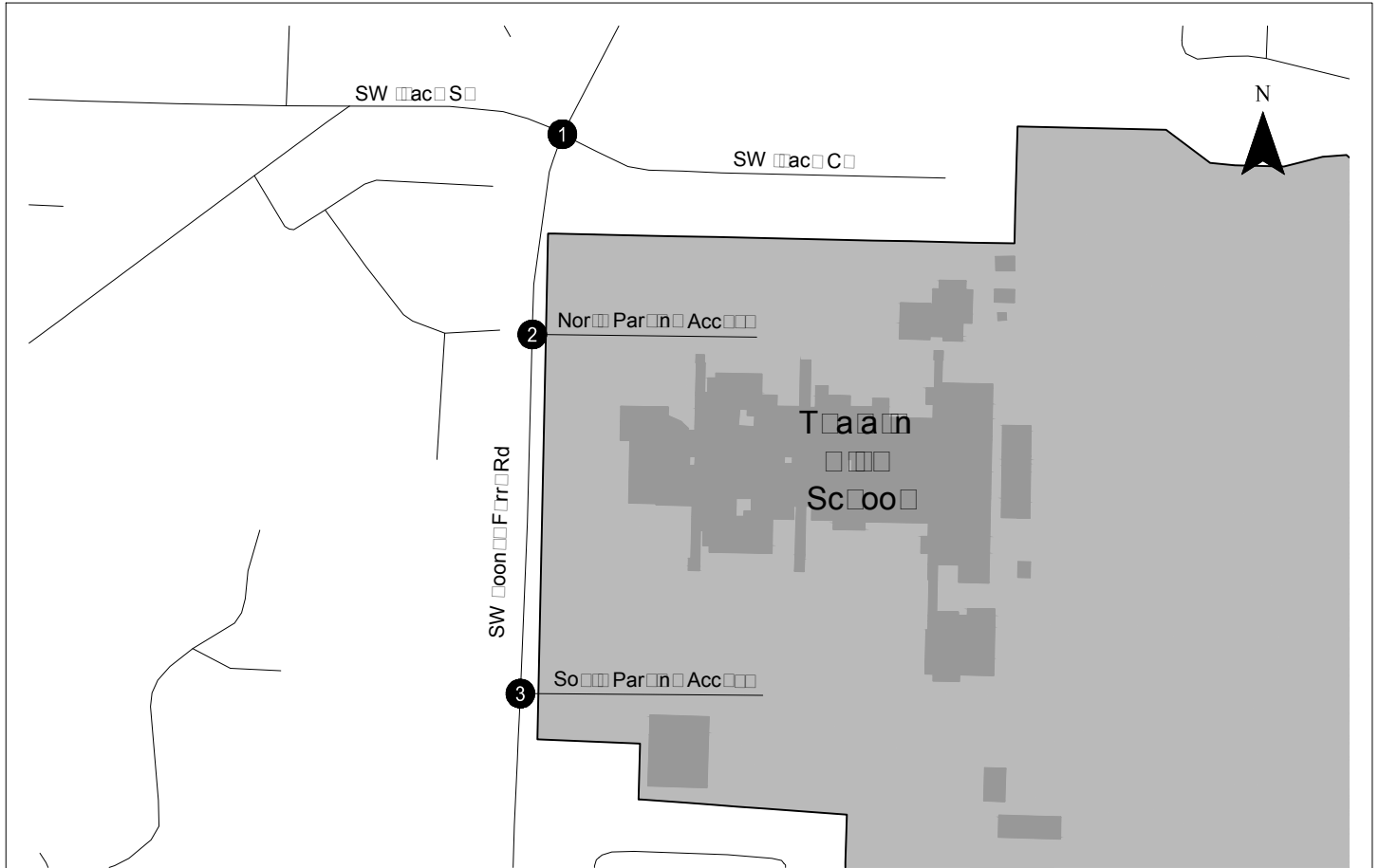

AM PEAK HOUR VOLUMES

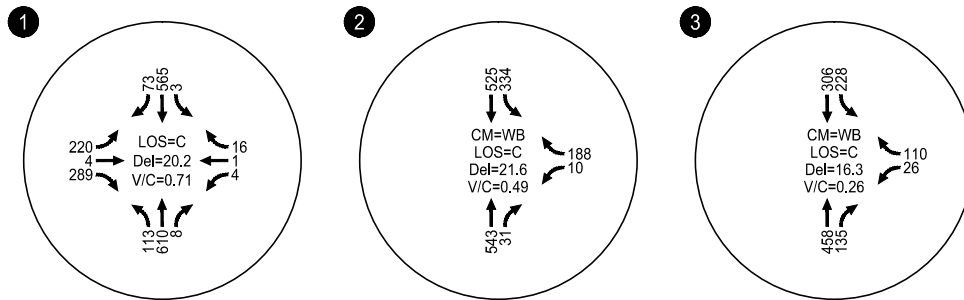

SCHOOL PM PEAK HOUR VOLUMES

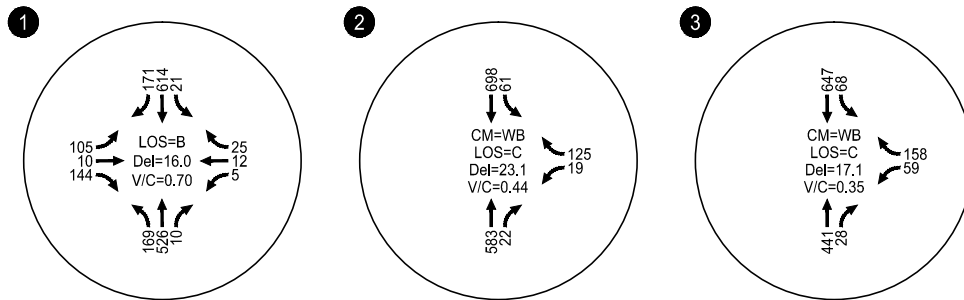

Existing Traffic Volumes
AM & School PM Peak Hours
Tualatin, Oregon

Figure
4

Table 2 – Existing Traffic Conditions

Intersection	Maximum Operating Standard	Weekday AM Peak Hour		Weekday School PM Peak Hour	
		LOS	V/C	LOS	V/C
Signalized Intersections					
SW Boones Ferry Road / SW Ibach Street	LOS D ¹	C	0.71	B	0.70
Unsignalized Intersections²					
SW Boones Ferry Road / North School Driveway	LOS E ¹	C	0.49	C	0.44
SW Boones Ferry Road / South School Driveway	LOS E ¹	C	0.26	C	0.35

Notes:

¹ The City of Tualatin considers LOS “D” acceptable at signalized intersections and LOS “E” acceptable at unsignalized intersections.

² LOS and V/C for unsignalized intersections reported for the highest delay or critical movement.

Crash Data

Washington County maintains a Safety Priority Index System (SPIS) list to identify existing hazardous intersections for potential safety improvements. Intersections are included in the SPIS list if they have three or more crashes or if they have one or more severe injury or fatal crashes within three consecutive years. No study intersections appear on the Washington County SPIS list dated 2011 to 2013.

The Oregon Department of Transportation (ODOT) provided crash data along the school’s SW Boones Ferry Road frontage for the period from January 1, 2011 through December 31, 2015. *Appendix “C” contains the crash worksheets.* Table 3 illustrates the various reported crash types. One of the reported crashes involved a pedestrian and was attributed to a passenger vehicle (operated by a teenage driver in violation of graduated license) failing to yield the right-of-way to the pedestrian while turning left from SW Ibach Street onto SW Boones Ferry Road. No fatalities were reported at the study intersections for the five-year period.

Table 3 – Intersection and Segment Crash History (January 1, 20011 through December 31, 2015)

	Crash Type					Crash Severity	
	Rear-End	Turning	Angle	Ped	Other	PDO	Injury
SW Ibach Street / SW Boones Ferry Road	0	3	0	1	0	1	3
SW Boones Ferry Road / North School Driveway	5	0	0	0	0	1	4
SW Boones Ferry Road / South School Driveway	4	2	0	0	0	5	1

A closer review of the crashes summarized in Table 3 revealed that the largest number of crashes were read-end collisions occurring along the SW Boones Ferry Road corridor at or near the two school driveways. However, these crashes occurred at various hours of the day and only a couple occurred at what would be considered a peak school period. No other discernable patterns were found that suggest there are existing safety issues at the school driveways.

TRAFFIC IMPACT CONSIDERATIONS

Proposed Expansion Plan

The Tigard-Tualatin School District is proposing to expand and modernize various program space at Tualatin High School in order to better accommodate an existing and planned enrollment capacity of approximately 2,000 students. The school bond-driven project will include the creation of a new focal entry point and affiliated relocation of administrative offices, expansion of the existing Commons, expansion of the Career Technical Education spaces, and expansion to the fitness and locker rooms. Figure 2 illustrates the proposed site plan for the expanded school building. As indicated by the figure, all building expansions will occur on the existing school grounds and no modifications to the parking areas, circulation roadways, or campus access driveways are proposed.

Although these improvements will create additional building square footage, no new classroom space is being planned that would allow the high school to expand its enrollment capacity much beyond current enrollment numbers. Ten-year project enrollment projections for Tualatin High School provided by the School District project relatively steady enrollment as shown in Table 4. Based on this information, no measureable increase in student staff or bus trips are anticipated beyond existing conditions.

Furthermore, with the proposed building expansion occurring on existing school grounds, there will be no modifications or changes to the campus parking lots or vehicular circulation lanes. All existing site-generated traffic is anticipated to continue in its existing volumes, patterns, and frequencies.

Table 4 – Finished Capacity and Projected Enrollment

2016-17	2017-18	2018-19	2019-20	2020-21	2021-22	2022-23	2023-24	2024-25	2025-26	2026-27	2016-2027 Net Change
1,940	1,967	1,954	1,950	1,952	1,977	2,000	1,989	1,953	1,957	1,952	+12

Projections developed by PSU Center for Population Research in January 2017. Projections include River Terrace neighborhood build-out (located partially in the Tualatin High Boundary).

Given the study intersections operate acceptably today, that there is no discernable change in student enrollment projected for the ten-year future, and that no changes to site access, circulation, or parking are proposed on-site, we find no transportation mitigation measures are needed to support the proposed school expansion.

CONCLUSION

- The study intersections currently operate acceptably during peak school loading periods, including the two site access driveways (North Parking Access and South Parking Access).
- The Tigard-Tualatin School District is not intending nor anticipating that the expansion will accommodate increased student enrollment or faculty increase. Accordingly, no measurable increase in student, staff, or bus trips are anticipated beyond existing conditions.
- The proposed expansion does not modify the existing site layout and therefore, does not impact the traffic operations for the future expanded school facility.

Please contact us if you have any questions regarding our analysis findings or conclusion.

Sincerely,
KITTELSON & ASSOCIATES, INC.



Matt Hughart, AICP
Associate Planner



Nick Gross
Planner



Chris Brehmer, P.E.
Senior Principal Engineer

Appendix A Traffic Counts

LOCATION: SW Boones Ferry Rd -- SW Ibach St
CITY/STATE: Tualatin, OR

QC JOB #: 14391101
DATE: Thu, Apr 27 2017

Peak-Hour: 7:10 AM -- 8:10 AM
Peak 15-Min: 7:40 AM -- 7:55 AM

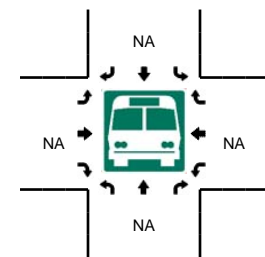
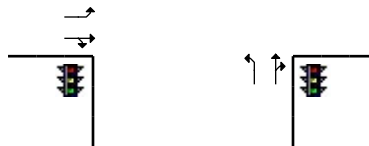
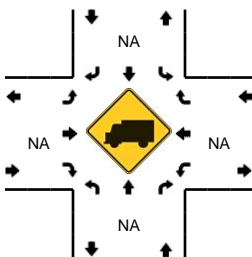
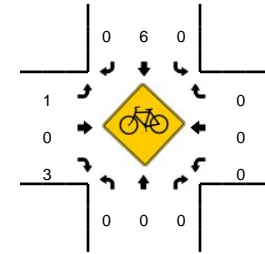
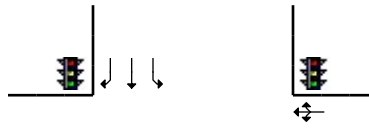
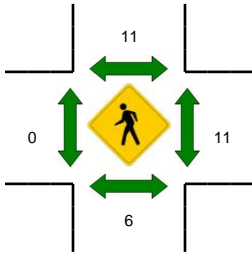
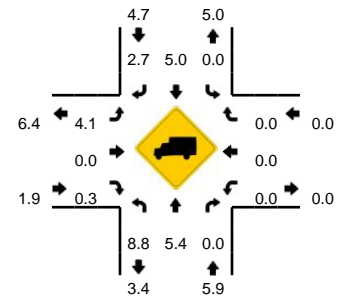
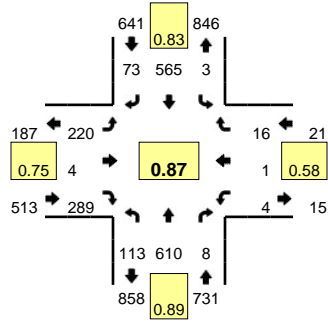

5-Min Count Period Beginning At	SW Boones Ferry Rd (Northbound)				SW Boones Ferry Rd (Southbound)				SW Ibach St (Eastbound)				SW Ibach St (Westbound)				Total	Hourly Totals
	Left	Thru	Right	U	Left	Thru	Right	U	Left	Thru	Right	U	Left	Thru	Right	U		
7:00 AM	5	47	1	0	0	18	2	0	23	0	8	0	1	0	0	0	105	
7:05 AM	3	44	0	0	0	23	4	0	25	0	4	0	0	0	0	0	103	
7:10 AM	2	54	0	0	1	30	3	0	14	0	9	0	2	0	2	0	117	
7:15 AM	8	57	1	0	1	39	3	0	20	0	15	0	1	0	0	0	145	
7:20 AM	7	53	0	0	0	46	5	0	19	0	17	0	0	0	4	0	151	
7:25 AM	5	58	0	0	0	46	4	0	22	0	19	0	0	0	0	0	154	
7:30 AM	8	44	1	0	0	44	8	0	10	1	15	0	0	0	1	0	132	
7:35 AM	6	56	0	0	0	42	6	0	22	0	27	0	0	0	1	0	160	
7:40 AM	14	59	0	0	0	53	5	0	23	0	31	0	0	0	0	0	185	
7:45 AM	16	52	2	0	0	47	4	0	17	1	30	0	0	0	1	0	170	
7:50 AM	7	42	0	0	0	69	3	0	29	1	40	0	1	0	1	0	193	
7:55 AM	14	44	2	0	0	54	11	0	16	0	38	0	0	1	2	0	182	1797
8:00 AM	14	43	1	0	1	50	5	0	14	0	30	0	0	0	2	0	160	1852
8:05 AM	12	48	1	0	0	45	16	0	14	1	18	0	0	0	2	0	157	1906
8:10 AM	4	39	0	0	0	35	16	0	18	0	3	0	0	0	1	0	116	1905
8:15 AM	3	33	0	0	0	33	5	0	17	0	5	0	0	0	0	0	96	1856
8:20 AM	8	43	2	0	0	30	7	0	19	1	6	0	0	0	0	0	116	1821
8:25 AM	7	29	0	0	0	27	9	0	16	1	6	0	0	2	0	0	97	1764
8:30 AM	2	35	0	0	0	25	5	0	8	0	6	0	0	0	0	0	81	1713
8:35 AM	4	22	1	0	0	22	4	0	17	0	3	0	0	0	0	0	73	1626
8:40 AM	5	26	0	0	0	30	12	0	16	0	8	0	0	0	0	0	97	1538
8:45 AM	3	33	0	0	1	15	4	0	21	0	5	0	0	0	1	0	83	1451
8:50 AM	5	24	0	0	0	16	4	0	17	0	6	0	1	0	1	0	74	1332
8:55 AM	7	22	0	0	0	22	7	0	16	0	4	0	0	0	0	0	78	1228
Peak 15-Min Flowrates	Northbound				Southbound				Eastbound				Westbound				Total	
	Left	Thru	Right	U	Left	Thru	Right	U	Left	Thru	Right	U	Left	Thru	Right	U		
All Vehicles	148	612	8	0	0	676	48	0	276	8	404	0	4	0	8	0	2192	
Heavy Trucks	4	12	0	0	0	12	0	0	8	0	0	0	0	0	0	0	36	
Pedestrians		12				12				0				12			36	
Bicycles	0	0	0	0	0	2	0	0	0	0	1	0	0	0	0	0	3	
Railroad																		
Stopped Buses																		

Comments:

LOCATION: SW Boones Ferry Rd -- North Parking Access
CITY/STATE: Tualatin, OR

QC JOB #: 14391103
DATE: Thu, Apr 27 2017

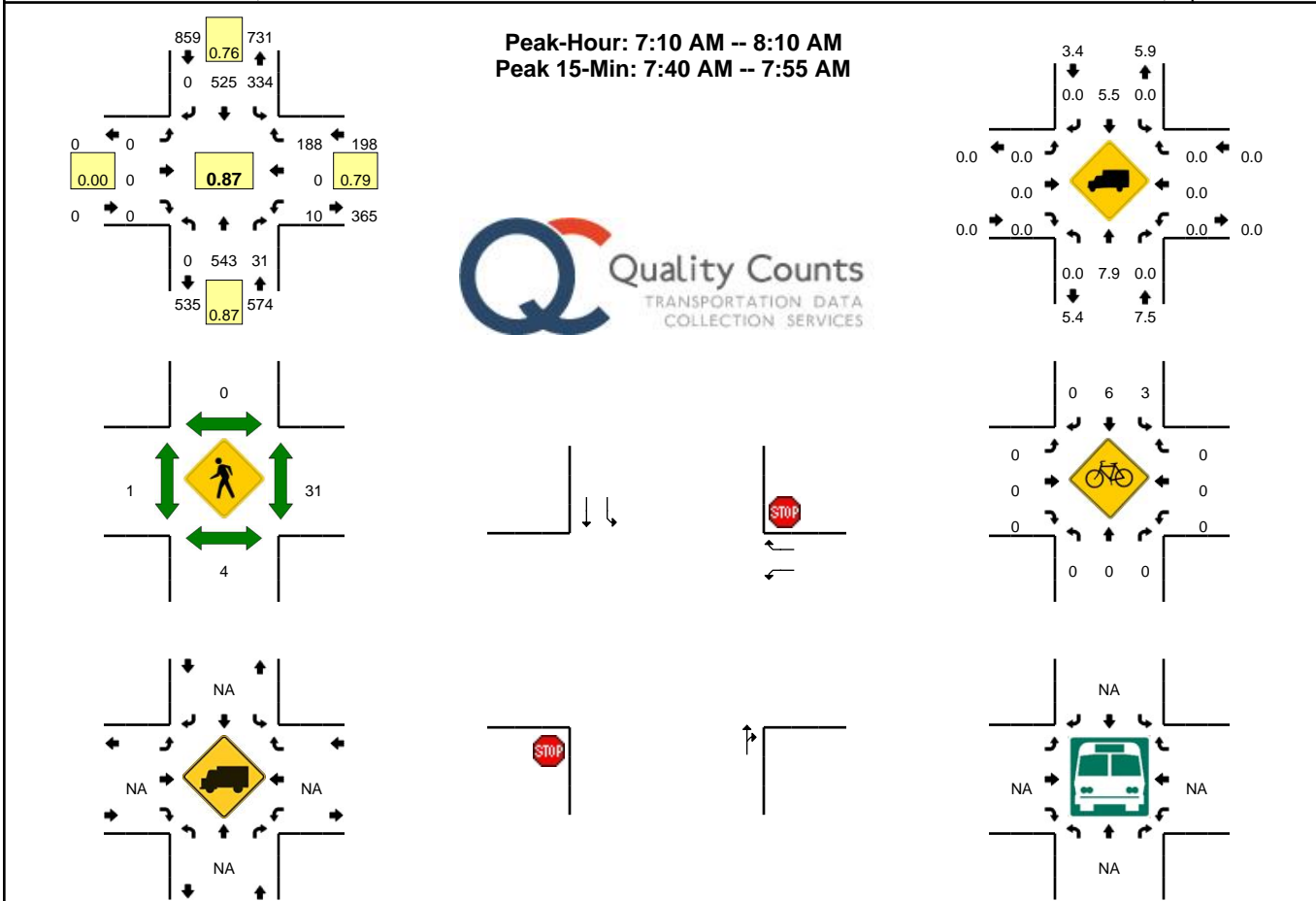

5-Min Count Period Beginning At	SW Boones Ferry Rd (Northbound)				SW Boones Ferry Rd (Southbound)				North Parking Access (Eastbound)				North Parking Access (Westbound)				Total	Hourly Totals
	Left	Thru	Right	U	Left	Thru	Right	U	Left	Thru	Right	U	Left	Thru	Right	U		
7:00 AM	0	52	1	0	2	25	0	0	0	0	0	0	1	0	0	0	81	
7:05 AM	0	45	1	0	7	19	0	0	0	0	0	0	0	0	2	0	74	
7:10 AM	0	48	2	0	9	30	0	0	0	0	0	0	0	0	7	0	96	
7:15 AM	0	61	3	0	14	38	0	0	0	0	0	0	1	0	8	0	125	
7:20 AM	0	51	0	0	24	42	0	0	0	0	0	0	0	0	11	0	128	
7:25 AM	0	44	1	0	25	40	0	0	0	0	0	0	2	0	14	0	126	
7:30 AM	0	38	3	0	25	35	0	0	0	0	0	0	2	0	18	0	121	
7:35 AM	0	50	2	0	19	48	0	0	0	0	0	0	1	0	15	0	135	
7:40 AM	0	53	4	0	32	51	0	0	0	0	0	0	0	0	20	0	160	
7:45 AM	0	43	1	0	34	44	0	0	0	0	0	0	0	0	23	0	145	
7:50 AM	0	42	2	0	38	68	0	0	0	0	0	0	0	0	13	0	163	
7:55 AM	0	39	8	0	43	43	0	0	0	0	0	0	1	0	17	0	151	1505
8:00 AM	0	30	2	0	50	40	0	0	0	0	0	0	2	0	26	0	150	1574
8:05 AM	0	44	3	0	21	46	0	0	0	0	0	0	1	0	16	0	131	1631
8:10 AM	0	37	0	0	7	28	0	0	0	0	0	0	0	0	4	0	76	1611
8:15 AM	0	29	1	0	2	36	0	0	0	0	0	0	2	0	6	0	76	1562
8:20 AM	0	52	0	0	2	39	0	0	0	0	0	0	0	0	3	0	96	1530
8:25 AM	0	34	0	0	1	32	0	0	0	0	0	0	0	0	0	0	67	1471
8:30 AM	0	37	1	0	4	27	0	0	0	0	0	0	2	0	0	0	71	1421
8:35 AM	0	30	1	0	1	22	0	0	0	0	0	0	0	0	1	0	55	1341
8:40 AM	0	28	1	0	1	38	0	0	0	0	0	0	0	0	1	0	69	1250
8:45 AM	0	33	0	0	1	20	0	0	0	0	0	0	0	0	1	0	55	1160
8:50 AM	0	28	1	0	2	21	0	0	0	0	0	0	0	0	0	0	52	1049
8:55 AM	0	28	0	0	4	21	0	0	0	0	0	0	0	0	1	0	54	952
Peak 15-Min Flowrates	Northbound				Southbound				Eastbound				Westbound				Total	
	Left	Thru	Right	U	Left	Thru	Right	U	Left	Thru	Right	U	Left	Thru	Right	U		
All Vehicles	0	552	28	0	416	652	0	0	0	0	0	0	0	0	224	0	1872	
Heavy Trucks	0	16	0	0	0	12	0	0	0	0	0	0	0	0	0	0	28	
Pedestrians	0	8	0	0	0	0	0	0	0	0	0	0	44	0	0	0	52	
Bicycles	0	0	0	0	0	2	0	0	0	0	0	0	0	0	0	0	2	
Railroad	0	0	0	0	0	0	0	0	0	0	0	0	0	0	0	0	0	
Stopped Buses	0	0	0	0	0	0	0	0	0	0	0	0	0	0	0	0	0	

Comments:

LOCATION: SW Boones Ferry Rd -- South Parking Access
CITY/STATE: Tualatin, OR

QC JOB #: 14391105
DATE: Thu, Apr 27 2017

Peak-Hour: 7:10 AM -- 8:10 AM
Peak 15-Min: 7:40 AM -- 7:55 AM

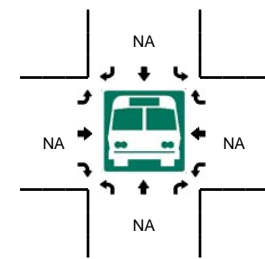
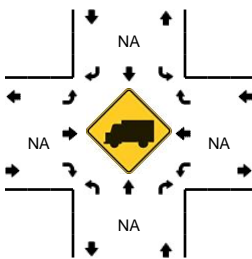
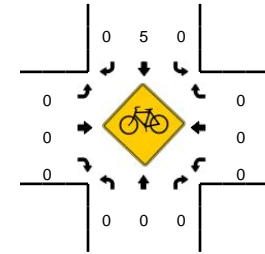
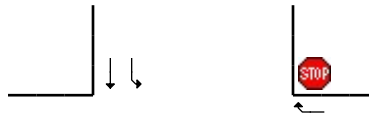
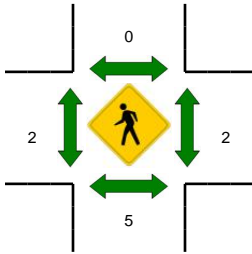
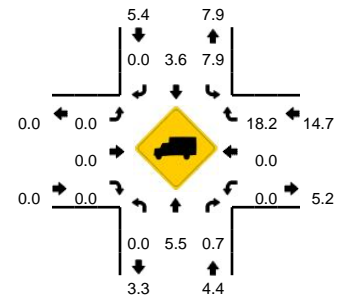
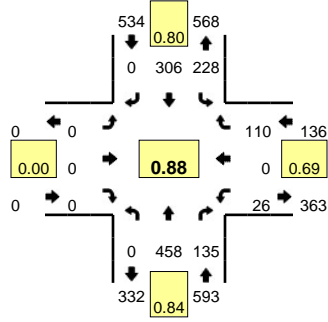

5-Min Count Period Beginning At	SW Boones Ferry Rd (Northbound)				SW Boones Ferry Rd (Southbound)				South Parking Access (Eastbound)				South Parking Access (Westbound)				Total	Hourly Totals
	Left	Thru	Right	U	Left	Thru	Right	U	Left	Thru	Right	U	Left	Thru	Right	U		
7:00 AM	0	46	3	0	6	17	0	0	0	0	0	0	1	0	4	0	77	
7:05 AM	0	46	4	0	5	13	0	0	0	0	0	0	1	0	2	0	71	
7:10 AM	0	48	10	0	12	20	0	0	0	0	0	0	1	0	3	0	94	
7:15 AM	0	55	7	0	16	18	0	0	0	0	0	0	1	0	11	0	108	
7:20 AM	0	48	8	0	25	17	0	0	0	0	0	0	0	0	2	0	100	
7:25 AM	0	35	18	0	17	26	0	0	0	0	0	0	3	0	7	0	106	
7:30 AM	0	30	12	0	16	22	0	0	0	0	0	0	2	0	9	0	91	
7:35 AM	0	43	8	0	14	27	0	0	0	0	0	0	3	0	11	0	106	
7:40 AM	0	44	10	0	23	34	0	0	0	0	0	0	4	0	12	0	127	
7:45 AM	0	37	10	0	17	29	0	0	0	0	0	0	2	0	7	0	102	
7:50 AM	0	30	18	0	28	35	0	0	0	0	0	0	4	0	14	0	129	
7:55 AM	0	33	19	0	23	21	0	0	0	0	0	0	3	0	11	0	110	1221
8:00 AM	0	16	12	0	25	23	0	0	0	0	0	0	1	0	16	0	93	1237
8:05 AM	0	39	3	0	12	34	0	0	0	0	0	0	2	0	7	0	97	1263
8:10 AM	0	33	3	0	4	25	0	0	0	0	0	0	0	0	3	0	68	1237
8:15 AM	0	29	2	0	0	39	0	0	0	0	0	0	1	0	2	0	73	1202
8:20 AM	0	46	1	0	4	35	0	0	0	0	0	0	1	0	3	0	90	1192
8:25 AM	0	28	0	0	4	26	0	0	0	0	0	0	1	0	4	0	63	1149
8:30 AM	0	36	1	0	1	29	0	0	0	0	0	0	0	0	2	0	69	1127
8:35 AM	0	33	0	0	0	19	0	0	0	0	0	0	0	0	0	0	52	1073
8:40 AM	0	27	0	0	2	36	0	0	0	0	0	0	0	0	2	0	67	1013
8:45 AM	0	32	1	0	1	18	0	0	0	0	0	0	0	0	0	0	52	963
8:50 AM	0	27	0	0	1	18	0	0	0	0	0	0	0	0	5	0	51	885
8:55 AM	0	27	0	0	3	19	0	0	0	0	0	0	0	0	0	0	49	824
Peak 15-Min Flowrates	Northbound				Southbound				Eastbound				Westbound				Total	
	Left	Thru	Right	U	Left	Thru	Right	U	Left	Thru	Right	U	Left	Thru	Right	U		
All Vehicles	0	444	152	0	272	392	0	0	0	0	0	0	40	0	132	0	1432	
Heavy Trucks	0	12	0	0	0	12	0	0	0	0	0	0	0	0	4	0	28	
Pedestrians	12				0					0			4				16	
Bicycles	0	0	0	0	0	1	0	0	0	0	0	0	0	0	0	0	1	
Railroad																		
Stopped Buses																		

Comments:

LOCATION: SW Boones Ferry Rd -- SW Ibach St
CITY/STATE: Tualatin, OR

QC JOB #: 14391102
DATE: Thu, Apr 27 2017

Peak-Hour: 2:45 PM -- 3:45 PM
Peak 15-Min: 3:10 PM -- 3:25 PM

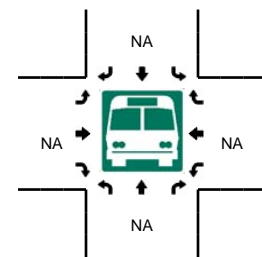
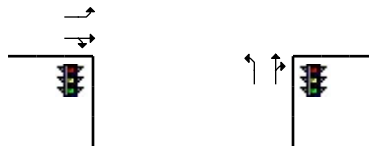
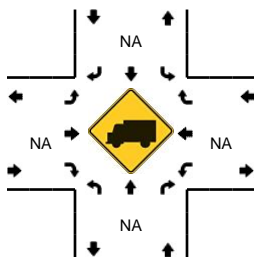
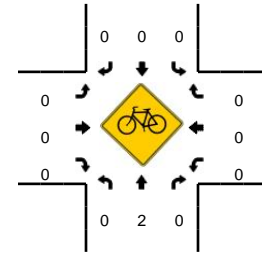
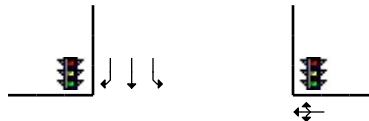
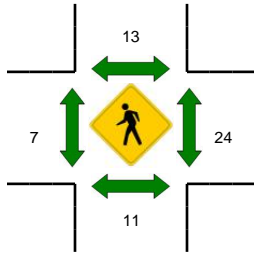
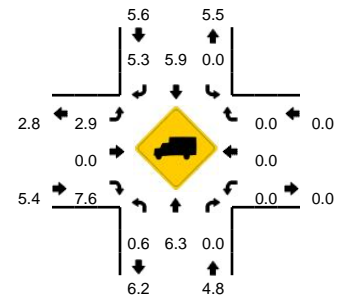
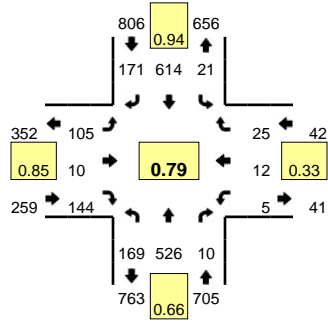

5-Min Count Period Beginning At	SW Boones Ferry Rd (Northbound)				SW Boones Ferry Rd (Southbound)				SW Ibach St (Eastbound)				SW Ibach St (Westbound)				Total	Hourly Totals
	Left	Thru	Right	U	Left	Thru	Right	U	Left	Thru	Right	U	Left	Thru	Right	U		
2:15 PM	6	32	0	0	0	28	12	0	9	0	5	0	0	0	1	0	93	
2:20 PM	4	26	0	0	0	35	11	0	9	0	11	0	0	0	0	0	96	
2:25 PM	10	29	0	0	1	34	6	0	7	0	9	0	0	0	0	0	96	
2:30 PM	8	31	0	0	1	31	7	0	8	0	8	0	0	0	1	0	95	
2:35 PM	2	30	0	0	3	47	9	0	5	0	8	0	0	0	0	0	104	
2:40 PM	5	32	0	0	3	51	14	0	4	0	11	0	1	0	0	0	121	
2:45 PM	5	25	0	0	2	57	18	0	5	0	9	0	0	0	0	0	121	
2:50 PM	13	30	0	0	1	59	12	0	15	1	17	0	1	0	0	0	149	
2:55 PM	9	36	3	0	2	40	10	0	10	2	12	0	1	0	0	0	125	1273
3:00 PM	14	38	3	0	5	44	12	0	7	1	11	0	1	1	0	0	137	1331
3:05 PM	18	54	2	0	1	54	12	0	12	2	4	0	0	0	5	0	164	1379
3:10 PM	25	58	1	0	5	56	11	0	10	4	10	0	1	7	8	0	196	1497
3:15 PM	23	62	0	0	2	52	20	0	4	0	17	0	0	3	8	0	191	1595
3:20 PM	21	78	0	0	0	46	13	0	11	0	13	0	0	0	2	0	184	1683
3:25 PM	12	30	0	0	3	36	19	0	13	0	11	0	0	0	1	0	125	1712
3:30 PM	11	28	0	0	0	51	17	0	7	0	10	0	0	0	0	0	124	1741
3:35 PM	9	49	1	0	0	45	14	0	7	0	20	0	0	1	1	0	147	1784
3:40 PM	9	38	0	0	0	74	13	0	4	0	10	0	1	0	0	0	149	1812
3:45 PM	5	30	0	0	0	54	19	0	18	1	14	0	0	0	0	0	141	1832
3:50 PM	9	33	0	0	0	65	19	0	12	1	15	0	0	0	1	0	155	1838
3:55 PM	6	31	0	0	1	56	15	0	13	0	5	0	1	1	0	0	129	1842
4:00 PM	8	35	0	0	1	54	16	0	11	0	10	0	0	1	0	0	136	1841
4:05 PM	5	53	0	0	0	63	16	0	21	0	11	0	0	0	0	0	169	1846
4:10 PM	4	38	0	0	1	45	12	0	14	1	5	0	1	0	0	0	121	1771
Peak 15-Min Flowrates	Northbound				Southbound				Eastbound				Westbound				Total	
	Left	Thru	Right	U	Left	Thru	Right	U	Left	Thru	Right	U	Left	Thru	Right	U		
All Vehicles	276	792	4	0	28	616	176	0	100	16	160	0	4	40	72	0	2284	
Heavy Trucks	4	88	0	0	0	32	0	0	4	0	4	0	0	0	0	0	132	
Pedestrians		24				32				16				48			120	
Bicycles	0	1	0		0	0	0		0	0	0		0	0	0		1	
Railroad																		
Stopped Buses																		

Comments:

LOCATION: SW Boones Ferry Rd -- North Parking Access
CITY/STATE: Tualatin, OR

QC JOB #: 14391104
DATE: Thu, Apr 27 2017

Peak-Hour: 2:45 PM -- 3:45 PM
Peak 15-Min: 3:10 PM -- 3:25 PM

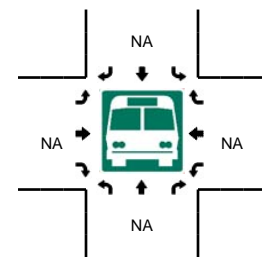
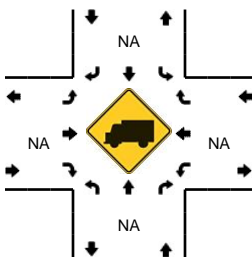
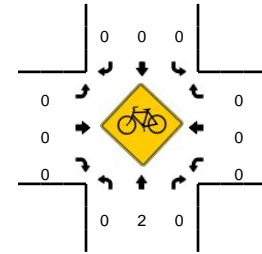
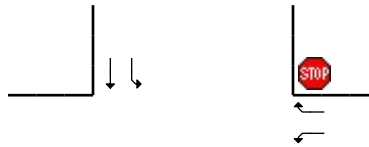
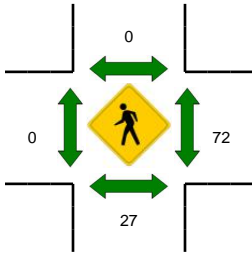
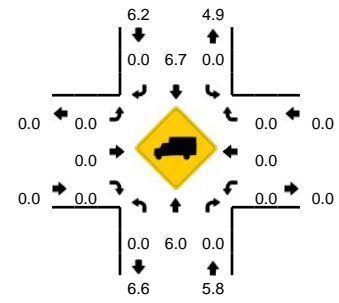
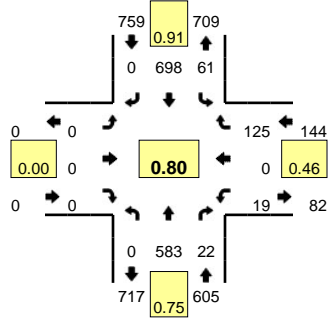

5-Min Count Period Beginning At	SW Boones Ferry Rd (Southbound)				SW Boones Ferry Rd (Southbound)				North Parking Access (Eastbound)				North Parking Access (Westbound)				Total	Hourly Totals	
	Left	Thru	Right	U	Left	Thru	Right	U	Left	Thru	Right	U	Left	Thru	Right	U			
2:15 PM	0	37	0	0	0	32	0	0	0	0	0	0	0	0	0	2	0	71	
2:20 PM	0	24	0	0	4	43	0	0	0	0	0	0	0	1	0	2	0	74	
2:25 PM	0	41	0	0	2	40	0	0	0	0	0	0	0	0	0	3	0	86	
2:30 PM	0	32	2	0	1	33	0	0	0	0	0	0	0	0	0	5	0	73	
2:35 PM	0	29	1	0	5	54	0	0	0	0	0	0	0	1	0	2	0	92	
2:40 PM	0	33	0	0	1	62	0	0	0	0	0	0	0	0	0	3	0	99	
2:45 PM	0	30	1	0	3	62	0	0	0	0	0	0	0	0	0	1	0	97	
2:50 PM	0	39	4	0	11	60	0	0	0	0	0	0	0	0	0	6	0	120	
2:55 PM	0	45	5	0	8	48	0	0	0	0	0	0	0	3	0	1	0	110	1040
3:00 PM	0	52	2	0	10	48	0	0	0	0	0	0	0	1	0	10	0	123	1101
3:05 PM	0	48	1	0	3	49	0	0	0	0	0	0	0	1	0	29	0	131	1139
3:10 PM	0	63	1	0	4	64	0	0	0	0	0	0	0	4	0	18	0	154	1230
3:15 PM	0	60	2	0	5	67	0	0	0	0	0	0	0	2	0	25	0	161	1320
3:20 PM	0	75	1	0	8	50	0	0	0	0	0	0	0	2	0	20	0	156	1402
3:25 PM	0	36	1	0	2	48	0	0	0	0	0	0	0	1	0	2	0	90	1406
3:30 PM	0	39	0	0	3	57	0	0	0	0	0	0	0	1	0	4	0	104	1437
3:35 PM	0	50	3	0	2	62	0	1	0	0	0	0	0	1	0	6	0	125	1470
3:40 PM	0	46	1	0	1	83	0	0	0	0	0	0	0	3	0	3	0	137	1508
3:45 PM	0	32	0	0	1	67	0	0	0	0	0	0	0	1	0	3	0	104	1515
3:50 PM	0	42	0	0	1	77	0	0	0	0	0	0	0	0	0	0	0	120	1515
3:55 PM	0	38	0	0	1	61	0	0	0	0	0	0	0	3	0	2	0	105	1510
4:00 PM	0	42	1	0	4	64	0	0	0	0	0	0	0	0	0	3	0	114	1501
4:05 PM	0	47	1	0	1	72	0	0	0	0	0	0	0	0	0	6	0	127	1497
4:10 PM	0	39	0	0	1	46	0	0	0	0	0	0	0	0	0	2	0	88	1431
Peak 15-Min Flowrates	Northbound				Southbound				Eastbound				Westbound				Total		
	Left	Thru	Right	U	Left	Thru	Right	U	Left	Thru	Right	U	Left	Thru	Right	U			
All Vehicles	0	792	16	0	68	724	0	0	0	0	0	0	0	32	0	252	0	1884	
Heavy Trucks	0	92	0	0	0	36	0	0	0	0	0	0	0	0	0	0	0	128	
Pedestrians		28				0								132				160	
Bicycles	0	1	0		0	0	0			0	0	0		0	0	0		1	
Railroad																			
Stopped Buses																			

Comments:

LOCATION: SW Boones Ferry Rd -- South Parking Access
CITY/STATE: Tualatin, OR

QC JOB #: 14391106
DATE: Thu, Apr 27 2017

Peak-Hour: 2:45 PM -- 3:45 PM
Peak 15-Min: 3:05 PM -- 3:20 PM

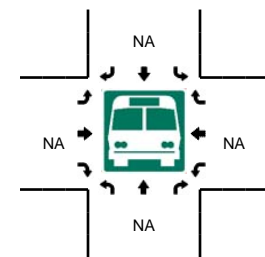
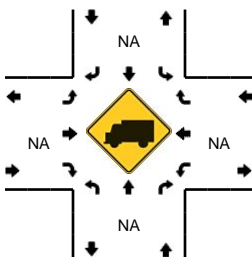
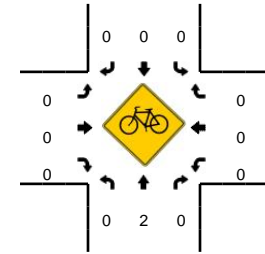
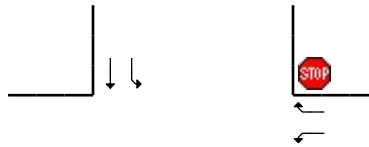
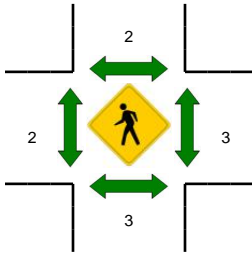
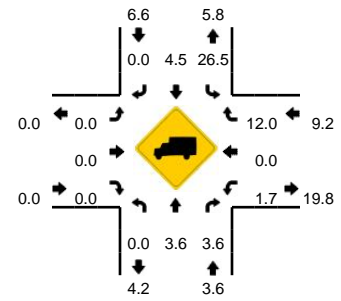
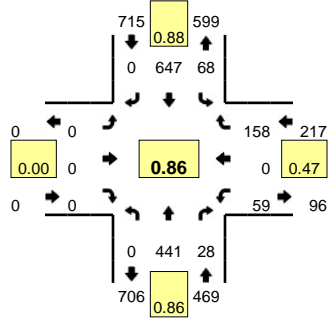

5-Min Count Period Beginning At	SW Boones Ferry Rd (Northbound)				SW Boones Ferry Rd (Southbound)				South Parking Access (Eastbound)				South Parking Access (Westbound)				Total	Hourly Totals
	Left	Thru	Right	U	Left	Thru	Right	U	Left	Thru	Right	U	Left	Thru	Right	U		
2:15 PM	0	30	0	0	0	30	0	0	0	0	0	0	1	0	3	0	64	
2:20 PM	0	19	0	0	1	35	0	0	0	0	0	0	0	0	1	0	56	
2:25 PM	0	37	2	0	2	40	0	0	0	0	0	0	1	0	1	0	83	
2:30 PM	0	31	2	0	2	27	0	0	0	0	0	0	1	0	2	0	65	
2:35 PM	0	26	1	0	2	56	0	0	0	0	0	0	1	0	3	0	89	
2:40 PM	0	35	0	0	4	62	0	0	0	0	0	0	0	0	0	0	101	
2:45 PM	0	29	2	0	3	54	0	0	0	0	0	0	0	0	1	0	89	
2:50 PM	0	37	2	0	7	50	0	0	0	0	0	0	0	0	8	0	104	
2:55 PM	0	48	2	0	14	45	0	0	0	0	0	0	2	0	4	0	115	969
3:00 PM	0	43	4	0	11	35	0	0	0	0	0	0	4	0	7	0	104	1021
3:05 PM	0	28	1	0	5	44	0	0	0	0	0	0	15	0	34	0	127	1059
3:10 PM	0	34	2	0	3	67	0	0	0	0	0	0	11	0	31	0	148	1145
3:15 PM	0	39	5	0	3	63	0	0	0	0	0	0	1	0	23	0	134	1215
3:20 PM	0	46	2	0	9	45	0	0	0	0	0	0	5	0	15	0	122	1281
3:25 PM	0	28	4	0	4	51	0	0	0	0	0	0	9	0	7	0	103	1301
3:30 PM	0	31	2	0	5	51	0	0	0	0	0	0	0	0	10	0	99	1335
3:35 PM	0	38	1	0	1	58	0	0	0	0	0	0	6	0	11	0	115	1361
3:40 PM	0	40	1	0	3	84	0	0	0	0	0	0	6	0	7	0	141	1401
3:45 PM	0	24	0	0	1	71	0	0	0	0	0	0	2	0	5	0	103	1415
3:50 PM	0	41	1	0	4	73	0	0	0	0	0	0	2	0	2	0	123	1434
3:55 PM	0	34	0	0	2	56	0	0	0	0	0	0	4	0	2	0	98	1417
4:00 PM	0	35	2	0	2	63	0	0	0	0	0	0	3	0	7	0	112	1425
4:05 PM	0	41	1	0	2	73	0	0	0	0	0	0	4	0	7	0	128	1426
4:10 PM	0	37	0	0	3	43	0	0	0	0	0	0	3	0	4	0	90	1368
Peak 15-Min Flowrates	Northbound				Southbound				Eastbound				Westbound				Total	
	Left	Thru	Right	U	Left	Thru	Right	U	Left	Thru	Right	U	Left	Thru	Right	U		
All Vehicles	0	404	32	0	44	696	0	0	0	0	0	0	108	0	352	0	1636	
Heavy Trucks	0	20	0	0	16	48	0	0	0	0	0	0	4	0	72	0	160	
Pedestrians		8				4				4				8			24	
Bicycles	0	1	0		0	0	0			0	0	0	0	0	0		1	
Railroad																		
Stopped Buses																		

Comments:

Appendix B Existing Traffic Conditions

Existing 2017 Traffic Conditions
101: SW Boones Ferry Rd & SW Ibach St

AM Peak Hour
10/20/2017



Movement	EBL	EBT	EBR	WBL	WBT	WBR	NBL	NBT	NBR	SBL	SBT	SBR
Lane Configurations												
Traffic Volume (vph)	220	4	289	4	1	16	113	610	8	3	565	73
Future Volume (vph)	220	4	289	4	1	16	113	610	8	3	565	73
Ideal Flow (vphpl)	1900	1900	1900	1900	1900	1900	1900	1900	1900	1900	1900	1900
Total Lost time (s)	4.5	4.5			4.5		4.0	5.0		4.0	5.0	5.0
Lane Util. Factor	1.00	1.00			1.00		1.00	1.00		1.00	1.00	1.00
Frbp, ped/bikes	1.00	0.97			0.97		1.00	1.00		1.00	1.00	0.98
Flpb, ped/bikes	0.98	1.00			1.00		1.00	1.00		1.00	1.00	1.00
Frt	1.00	0.85			0.90		1.00	1.00		1.00	1.00	0.85
Flt Protected	0.95	1.00			0.99		0.95	1.00		0.95	1.00	1.00
Satd. Flow (prot)	1701	1564			1637		1656	1806		1805	1810	1529
Flt Permitted	0.74	1.00			0.93		0.22	1.00		0.25	1.00	1.00
Satd. Flow (perm)	1328	1564			1541		389	1806		470	1810	1529
Peak-hour factor, PHF	0.87	0.87	0.87	0.87	0.87	0.87	0.87	0.87	0.87	0.87	0.87	0.87
Adj. Flow (vph)	253	5	332	5	1	18	130	701	9	3	649	84
RTOR Reduction (vph)	0	248	0	0	13	0	0	0	0	0	0	29
Lane Group Flow (vph)	253	89	0	0	11	0	130	710	0	3	649	55
Confl. Peds. (#/hr)	11		6	6		11			11	11		
Confl. Bikes (#/hr)												6
Heavy Vehicles (%)	4%	0%	0%	0%	0%	0%	9%	5%	0%	0%	5%	3%
Turn Type	Perm	NA		Perm	NA		D.P+P	NA		D.P+P	NA	Perm
Protected Phases		4			8		5	2		1	6	
Permitted Phases	4			8			6			2		6
Actuated Green, G (s)	21.0	21.0			21.0		48.6	47.9		48.6	40.6	40.6
Effective Green, g (s)	21.0	21.0			21.0		48.6	47.9		48.6	40.6	40.6
Actuated g/C Ratio	0.25	0.25			0.25		0.58	0.58		0.58	0.49	0.49
Clearance Time (s)	4.5	4.5			4.5		4.0	5.0		4.0	5.0	5.0
Vehicle Extension (s)	2.3	2.3			2.5		2.3	4.3		2.3	4.3	4.3
Lane Grp Cap (vph)	335	395			389		349	1041		286	884	747
v/s Ratio Prot		0.06					c0.04	c0.39		0.00	c0.36	
v/s Ratio Perm	c0.19				0.01		0.18			0.01		0.04
v/c Ratio	0.76	0.23			0.03		0.37	0.68		0.01	0.73	0.07
Uniform Delay, d1	28.7	24.6			23.4		10.4	12.3		9.1	16.9	11.3
Progression Factor	1.00	1.00			1.00		1.00	1.00		1.00	1.00	1.00
Incremental Delay, d2	8.7	0.2			0.0		0.4	2.1		0.0	3.5	0.1
Delay (s)	37.3	24.8			23.4		10.8	14.4		9.1	20.5	11.3
Level of Service	D	C			C		B	B		A	C	B
Approach Delay (s)		30.2			23.4			13.8			19.4	
Approach LOS		C			C			B			B	

Intersection Summary

HCM 2000 Control Delay	20.2	HCM 2000 Level of Service	C
HCM 2000 Volume to Capacity ratio	0.71		
Actuated Cycle Length (s)	83.1	Sum of lost time (s)	13.5
Intersection Capacity Utilization	66.1%	ICU Level of Service	C
Analysis Period (min)	15		
c Critical Lane Group			

Existing 2017 Traffic Conditions
 102: SW Boones Ferry Rd & North Parking Access

AM Peak Hour
 10/20/2017



Movement	WBL	WBR	NBT	NBR	SBL	SBT
Lane Configurations						
Traffic Volume (veh/h)	10	188	543	31	334	525
Future Volume (Veh/h)	10	188	543	31	334	525
Sign Control	Stop		Free		Free	
Grade	0%		0%		0%	
Peak Hour Factor	0.87	0.87	0.87	0.87	0.87	0.87
Hourly flow rate (vph)	11	216	624	36	384	603
Pedestrians	31		4			
Lane Width (ft)	12.0		12.0			
Walking Speed (ft/s)	3.5		3.5			
Percent Blockage	3		0			
Right turn flare (veh)	3					
Median type	TWLTL			None		
Median storage (veh)	2					
Upstream signal (ft)				349		
pX, platoon unblocked	0.79					
vC, conflicting volume	2048	673			691	
vC1, stage 1 conf vol	673					
vC2, stage 2 conf vol	1375					
vCu, unblocked vol	2197	673			691	
tC, single (s)	6.4	6.2			4.1	
tC, 2 stage (s)	5.4					
tF (s)	3.5	3.3			2.2	
p0 queue free %	89	51			57	
cM capacity (veh/h)	104	445			886	

Direction, Lane #	WB 1	NB 1	SB 1	SB 2
Volume Total	227	660	384	603
Volume Left	11	0	384	0
Volume Right	216	36	0	0
cSH	468	1700	886	1700
Volume to Capacity	0.49	0.39	0.43	0.35
Queue Length 95th (ft)	65	0	55	0
Control Delay (s)	21.6	0.0	12.1	0.0
Lane LOS	C		B	
Approach Delay (s)	21.6	0.0	4.7	
Approach LOS	C			

Intersection Summary

Average Delay	5.1			
Intersection Capacity Utilization	62.4%		ICU Level of Service	B
Analysis Period (min)	15			

Existing 2017 Traffic Conditions
 103: SW Boones Ferry Rd & South Parking Access

AM Peak Hour
 10/20/2017



Movement	WBL	WBR	NBT	NBR	SBL	SBT
Lane Configurations						
Traffic Volume (veh/h)	26	110	458	135	228	306
Future Volume (Veh/h)	26	110	458	135	228	306
Sign Control	Stop		Free		Free	
Grade	0%		0%		0%	
Peak Hour Factor	0.88	0.88	0.88	0.88	0.88	0.88
Hourly flow rate (vph)	30	125	520	153	259	348
Pedestrians	2		5			
Lane Width (ft)	12.0		12.0			
Walking Speed (ft/s)	3.5		3.5			
Percent Blockage	0		0			
Right turn flare (veh)	3					
Median type			TWLTL		TWLTL	
Median storage (veh)			2		2	
Upstream signal (ft)					1102	
pX, platoon unblocked						
vC, conflicting volume	1470	598			675	
vC1, stage 1 conf vol	598					
vC2, stage 2 conf vol	871					
vCu, unblocked vol	1470	598			675	
tC, single (s)	6.4	6.4			4.2	
tC, 2 stage (s)	5.4					
tF (s)	3.5	3.5			2.3	
p0 queue free %	89	74			71	
cM capacity (veh/h)	263	473			887	

Direction, Lane #	WB 1	NB 1	SB 1	SB 2
Volume Total	155	673	259	348
Volume Left	30	0	259	0
Volume Right	125	153	0	0
cSH	586	1700	887	1700
Volume to Capacity	0.26	0.40	0.29	0.20
Queue Length 95th (ft)	26	0	30	0
Control Delay (s)	16.3	0.0	10.7	0.0
Lane LOS	C		B	
Approach Delay (s)	16.3	0.0	4.6	
Approach LOS	C			

Intersection Summary			
Average Delay			3.7
Intersection Capacity Utilization	58.3%		ICU Level of Service
Analysis Period (min)	15		B

Existing 2017 Traffic Conditions
101: SW Boones Ferry Rd & SW Ibach St

School PM Peak Hour
10/20/2017



Movement	EBL	EBT	EBR	WBL	WBT	WBR	NBL	NBT	NBR	SBL	SBT	SBR
Lane Configurations												
Traffic Volume (vph)	105	10	144	5	12	25	169	526	10	21	614	171
Future Volume (vph)	105	10	144	5	12	25	169	526	10	21	614	171
Ideal Flow (vphpl)	1900	1900	1900	1900	1900	1900	1900	1900	1900	1900	1900	1900
Total Lost time (s)	4.5	4.5			4.5		4.0	5.0		4.0	5.0	5.0
Lane Util. Factor	1.00	1.00			1.00		1.00	1.00		1.00	1.00	1.00
Frbp, ped/bikes	1.00	0.96			0.97		1.00	1.00		1.00	1.00	0.96
Flpb, ped/bikes	0.98	1.00			1.00		1.00	1.00		1.00	1.00	1.00
Frt	1.00	0.86			0.92		1.00	1.00		1.00	1.00	0.85
Flt Protected	0.95	1.00			0.99		0.95	1.00		0.95	1.00	1.00
Satd. Flow (prot)	1713	1455			1686		1787	1786		1797	1792	1482
Flt Permitted	0.85	1.00			0.96		0.19	1.00		0.31	1.00	1.00
Satd. Flow (perm)	1534	1455			1629		353	1786		587	1792	1482
Peak-hour factor, PHF	0.79	0.79	0.79	0.79	0.79	0.79	0.79	0.79	0.79	0.79	0.79	0.79
Adj. Flow (vph)	133	13	182	6	15	32	214	666	13	27	777	216
RTOR Reduction (vph)	0	152	0	0	27	0	0	0	0	0	0	53
Lane Group Flow (vph)	133	43	0	0	26	0	214	679	0	27	777	163
Confl. Peds. (#/hr)	13		11	11			13	7		24	24	7
Confl. Bikes (#/hr)									2			
Heavy Vehicles (%)	3%	0%	8%	0%	0%	0%	1%	6%	0%	0%	6%	5%
Turn Type	Perm	NA		Perm	NA		D.P+P	NA		D.P+P	NA	Perm
Protected Phases		4			8		5	2		1	6	
Permitted Phases	4			8			6			2		6
Actuated Green, G (s)	13.7	13.7			13.7		54.7	52.9		54.7	45.6	45.6
Effective Green, g (s)	13.7	13.7			13.7		54.7	52.9		54.7	45.6	45.6
Actuated g/C Ratio	0.17	0.17			0.17		0.67	0.65		0.67	0.56	0.56
Clearance Time (s)	4.5	4.5			4.5		4.0	5.0		4.0	5.0	5.0
Vehicle Extension (s)	2.3	2.3			2.5		2.3	4.3		2.3	4.3	4.3
Lane Grp Cap (vph)	256	243			272		395	1153		418	997	825
v/s Ratio Prot		0.03					c0.06	0.38		0.00	c0.43	
v/s Ratio Perm	c0.09				0.02		0.30			0.04		0.11
v/c Ratio	0.52	0.18			0.10		0.54	0.59		0.06	0.78	0.20
Uniform Delay, d1	31.1	29.3			28.9		9.6	8.3		5.6	14.2	9.0
Progression Factor	1.00	1.00			1.00		1.00	1.00		1.00	1.00	1.00
Incremental Delay, d2	1.1	0.2			0.1		1.0	1.0		0.0	4.3	0.2
Delay (s)	32.2	29.5			29.0		10.7	9.3		5.6	18.5	9.2
Level of Service	C	C			C		B	A		A	B	A
Approach Delay (s)		30.6			29.0			9.6			16.2	
Approach LOS		C			C			A			B	

Intersection Summary

HCM 2000 Control Delay	16.0	HCM 2000 Level of Service	B
HCM 2000 Volume to Capacity ratio	0.70		
Actuated Cycle Length (s)	81.9	Sum of lost time (s)	13.5
Intersection Capacity Utilization	65.9%	ICU Level of Service	C
Analysis Period (min)	15		
c Critical Lane Group			

Existing 2017 Traffic Conditions
 102: SW Boones Ferry Rd & North Parking Access

School PM Peak Hour
 10/20/2017



Movement	WBL	WBR	NBT	NBR	SBL	SBT
Lane Configurations						
Traffic Volume (veh/h)	19	125	583	22	61	698
Future Volume (Veh/h)	19	125	583	22	61	698
Sign Control	Stop		Free			Free
Grade	0%		0%			0%
Peak Hour Factor	0.80	0.80	0.80	0.80	0.80	0.80
Hourly flow rate (vph)	24	156	729	28	76	873
Pedestrians	72		27			
Lane Width (ft)	12.0		12.0			
Walking Speed (ft/s)	3.5		3.5			
Percent Blockage	7		3			
Right turn flare (veh)		3				
Median type			TWLTL			None
Median storage (veh)			2			
Upstream signal (ft)						349
pX, platoon unblocked	0.66					
vC, conflicting volume	1867	815			829	
vC1, stage 1 conf vol	815					
vC2, stage 2 conf vol	1052					
vCu, unblocked vol	2060	815			829	
tC, single (s)	6.4	6.2			4.1	
tC, 2 stage (s)	5.4					
tF (s)	3.5	3.3			2.2	
p0 queue free %	88	56			90	
cM capacity (veh/h)	208	354			756	

Direction, Lane #	WB 1	NB 1	SB 1	SB 2
Volume Total	180	757	76	873
Volume Left	24	0	76	0
Volume Right	156	28	0	0
cSH	409	1700	756	1700
Volume to Capacity	0.44	0.45	0.10	0.51
Queue Length 95th (ft)	55	0	8	0
Control Delay (s)	23.1	0.0	10.3	0.0
Lane LOS	C		B	
Approach Delay (s)	23.1	0.0	0.8	
Approach LOS	C			

Intersection Summary			
Average Delay		2.6	
Intersection Capacity Utilization		48.9%	ICU Level of Service
Analysis Period (min)		15	A

Existing 2017 Traffic Conditions
 103: SW Boones Ferry Rd & South Parking Access

School PM Peak Hour
 10/20/2017



Movement	WBL	WBR	NBT	NBR	SBL	SBT
Lane Configurations						
Traffic Volume (veh/h)	59	158	441	28	68	647
Future Volume (Veh/h)	59	158	441	28	68	647
Sign Control	Stop		Free			Free
Grade	0%		0%			0%
Peak Hour Factor	0.86	0.86	0.86	0.86	0.86	0.86
Hourly flow rate (vph)	69	184	513	33	79	752
Pedestrians	3		3			2
Lane Width (ft)	12.0		12.0			12.0
Walking Speed (ft/s)	3.5		3.5			3.5
Percent Blockage	0		0			0
Right turn flare (veh)		3				
Median type			TWLTL			TWLTL
Median storage (veh)			2			2
Upstream signal (ft)						1102
pX, platoon unblocked	0.73					
vC, conflicting volume	1446	534			549	
vC1, stage 1 conf vol	532					
vC2, stage 2 conf vol	913					
vCu, unblocked vol	1425	534			549	
tC, single (s)	6.4	6.3			4.4	
tC, 2 stage (s)	5.4					
tF (s)	3.5	3.4			2.4	
p0 queue free %	76	65			91	
cM capacity (veh/h)	292	524			908	

Direction, Lane #	WB 1	NB 1	SB 1	SB 2
Volume Total	253	546	79	752
Volume Left	69	0	79	0
Volume Right	184	33	0	0
cSH	721	1700	908	1700
Volume to Capacity	0.35	0.32	0.09	0.44
Queue Length 95th (ft)	40	0	7	0
Control Delay (s)	17.1	0.0	9.3	0.0
Lane LOS	C		A	
Approach Delay (s)	17.1	0.0	0.9	
Approach LOS	C			

Intersection Summary			
Average Delay		3.1	
Intersection Capacity Utilization		44.7%	ICU Level of Service
Analysis Period (min)		15	A

Appendix C Crash Data

OREGON DEPARTMENT OF TRANSPORTATION - TRANSPORTATION DEVELOPMENT DIVISION
 TRANSPORTATION DATA SECTION - CRASH ANALYSIS AND REPORTING UNIT
 CRASH SUMMARIES BY YEAR BY COLLISION TYPE

SW Boones Ferry Rd & SW Ibach St / SW Ibach Ct
 January 1, 2011 through December 31, 2015

COLLISION TYPE	FATAL CRASHES	NON- FATAL CRASHES	PROPERTY DAMAGE ONLY	TOTAL CRASHES	PEOPLE KILLED	PEOPLE INJURED	TRUCKS	DRY SURF	WET SURF	DAY	DARK	INTER- SECTION	INTER- SECTION RELATED	OFF- ROAD
YEAR: 2014														
PEDESTRIAN	0	1	0	1	0	1	0	1	0	1	0	1	0	0
2014 TOTAL	0	1	0	1	0	1	0	1	0	1	0	1	0	0
YEAR: 2013														
TURNING MOVEMENTS	0	0	1	1	0	0	0	1	0	0	1	1	0	0
2013 TOTAL	0	0	1	1	0	0	0	1	0	0	1	1	0	0
YEAR: 2012														
TURNING MOVEMENTS	0	2	0	2	0	2	0	1	1	0	2	2	0	0
2012 TOTAL	0	2	0	2	0	2	0	1	1	0	2	2	0	0
FINAL TOTAL	0	3	1	4	0	3	0	3	1	1	3	4	0	0

Disclaimer: A higher number of crashes may be reported as of 2011 compared to prior years. This does not reflect an increase in annual crashes. The higher numbers result from a change to an internal departmental process that allows the Crash Analysis and Reporting Unit to add previously unavailable, non-fatal crash reports to the annual data file. Please be aware of this change when comparing pre-2011 crash statistics.

ACTION CODE TRANSLATION LIST

ACTION CODE	SHORT DESCRIPTION	LONG DESCRIPTION
000	NONE	NO ACTION OR NON-WARRANTED
001	SKIDDED	SKIDDED
002	ON/OFF V	GETTING ON OR OFF STOPPED OR PARKED VEHICLE
003	LOAD OVR	OVERHANGING LOAD STRUCK ANOTHER VEHICLE, ETC.
006	SLOW DN	SLOWED DOWN
007	AVOIDING	AVOIDING MANEUVER
008	PAR PARK	PARALLEL PARKING
009	ANG PARK	ANGLE PARKING
010	INTERFERE	PASSENGER INTERFERING WITH DRIVER
011	STOPPED	STOPPED IN TRAFFIC NOT WAITING TO MAKE A LEFT TURN
012	STP/L TRN	STOPPED BECAUSE OF LEFT TURN SIGNAL OR WAITING, ETC.
013	STP TURN	STOPPED WHILE EXECUTING A TURN
014	EMR V PKD	EMERGENCY VEHICLE LEGALLY PARKED IN THE ROADWAY
015	GO A/STOP	PROCEED AFTER STOPPING FOR A STOP SIGN/FLASHING RED.
016	TRN A/RED	TURNE D ON RED AFTER STOPPING
017	LOSTCTRL	LOST CONTROL OF VEHICLE
018	EXIT DWY	ENTERING STREET OR HIGHWAY FROM ALLEY OR DRIVEWAY
019	ENTR DWY	ENTERING ALLEY OR DRIVEWAY FROM STREET OR HIGHWAY
020	STR ENTR	BEFORE ENTERING ROADWAY, STRUCK PEDESTRIAN, ETC. ON SIDEWALK OR SHOULDER
021	NO DRVR	CAR RAN AWAY - NO DRIVER
022	PREV COL	STRUCK, OR WAS STRUCK BY, VEHICLE OR PEDESTRIAN IN PRIOR COLLISION BEFORE ACC. STABILIZED
023	STALLED	VEHICLE STALLED OR DISABLED
024	DRVR DEAD	DEAD BY UNASSOCIATED CAUSE
025	FATIGUE	FATIGUED, SLEEPY, ASLEEP
026	SUN	DRIVER BLINDED BY SUN
027	HDLGHTS	DRIVER BLINDED BY HEADLIGHTS
028	ILLNESS	PHYSICALLY ILL
029	THRU MED	VEHICLE CROSSED, PLUNGED OVER, OR THROUGH MEDIAN BARRIER
030	PURSUIT	PURSUIING OR ATTEMPTING TO STOP A VEHICLE
031	PASSING	PASSING SITUATION
032	PRKOFFRD	VEHICLE PARKED BEYOND CURB OR SHOULDER
033	CROS MED	VEHICLE CROSSED EARTH OR GRASS MEDIAN
034	X N/SGNL	CROSSING AT INTERSECTION - NO TRAFFIC SIGNAL PRESENT
035	X W/ SGNL	CROSSING AT INTERSECTION - TRAFFIC SIGNAL PRESENT
036	DIAGONAL	CROSSING AT INTERSECTION - DIAGONALLY
037	BTWN INT	CROSSING BETWEEN INTERSECTIONS
038	DISTRACT	DRIVER'S ATTENTION DISTRACTED
039	W/TRAF-S	WALKING, RUNNING, RIDING, ETC., ON SHOULDER WITH TRAFFIC
040	A/TRAF-S	WALKING, RUNNING, RIDING, ETC., ON SHOULDER FACING TRAFFIC
041	W/TRAF-P	WALKING, RUNNING, RIDING, ETC., ON PAVEMENT WITH TRAFFIC
042	A/TRAF-P	WALKING, RUNNING, RIDING, ETC., ON PAVEMENT FACING TRAFFIC
043	PLAYINRD	PLAYING IN STREET OR ROAD
044	PUSH MV	PUSHING OR WORKING ON VEHICLE IN ROAD OR ON SHOULDER
045	WORK ON	WORKING IN ROADWAY OR ALONG SHOULDER
046	W/ TRAFIC	NON-MOTORIST WALKING, RUNNING, RIDING, ETC. WITH TRAFFIC
047	A/ TRAFIC	NON-MOTORIST WALKING, RUNNING, RIDING, ETC. FACING TRAFFIC
050	LAY ON RD	STANDING OR LYING IN ROADWAY
051	ENT OFFRD	ENTERING / STARTING IN TRAFFIC LANE FROM OFF ROAD
052	MERGING	MERGING
055	SPRAY	BLINDED BY WATER SPRAY

ACTION CODE TRANSLATION LIST

ACTION CODE	SHORT DESCRIPTION	LONG DESCRIPTION
088	OTHER	OTHER ACTION
099	UNK	UNKNOWN ACTION

CAUSE CODE TRANSLATION LIST

CAUSE CODE	SHORT DESCRIPTION	LONG DESCRIPTION
00	NO CODE	NO CAUSE ASSOCIATED AT THIS LEVEL
01	TOO-FAST	TOO FAST FOR CONDITIONS (NOT EXCEED POSTED SPEED)
02	NO-YIELD	DID NOT YIELD RIGHT-OF-WAY
03	PAS-STOP	PASSED STOP SIGN OR RED FLASHER
04	DIS SIG	DISREGARDED TRAFFIC SIGNAL
05	LEFT-CTR	DROVE LEFT OF CENTER ON TWO-WAY ROAD; STRADDLING
06	IMP-OVER	IMPROPER OVERTAKING
07	TOO-CLOS	FOLLOWED TOO CLOSELY
08	IMP-TURN	MADE IMPROPER TURN
09	DRINKING	ALCOHOL OR DRUG INVOLVED
10	OTHR-IMP	OTHER IMPROPER DRIVING
11	MECH-DEF	MECHANICAL DEFECT
12	OTHER	OTHER (NOT IMPROPER DRIVING)
13	IMP LN C	IMPROPER CHANGE OF TRAFFIC LANES
14	DIS TCD	DISREGARDED OTHER TRAFFIC CONTROL DEVICE
15	WRNG WAY	WRONG WAY ON ONE-WAY ROAD; WRONG SIDE DIVIDED ROAD
16	FATIGUE	DRIVER DROWSY/FATIGUED/SLEEPY
17	ILLNESS	PHYSICAL ILLNESS
18	IN RDWY	NON-MOTORIST ILLEGALLY IN ROADWAY
19	NT VISBL	NON-MOTORIST NOT VISIBLE; NON-REFLECTIVE CLOTHING
20	IMP PKNG	VEHICLE IMPROPERLY PARKED
21	DEF STER	DEFECTIVE STEERING MECHANISM
22	DEF BRKE	INADEQUATE OR NO BRAKES
24	LOADSHFT	VEHICLE LOST LOAD OR LOAD SHIFTED
25	TIREFAIL	TIRE FAILURE
26	PHANTOM	PHANTOM / NON-CONTACT VEHICLE
27	INATTENT	INATTENTION
28	NM INATT	NON-MOTORIST INATTENTION
29	F AVOID	FAILED TO AVOID VEHICLE AHEAD
30	SPEED	DRIVING IN EXCESS OF POSTED SPEED
31	RACING	SPEED RACING (PER PAR)
32	CARELESS	CARELESS DRIVING (PER PAR)
33	RECKLESS	RECKLESS DRIVING (PER PAR)
34	AGGRESV	AGGRESSIVE DRIVING (PER PAR)
35	RD RAGE	ROAD RAGE (PER PAR)
40	VIEW OBS	VIEW OBSCURED
50	USED MDN	IMPROPER USE OF MEDIAN OR SHOULDER
51	FAIL LN	FAILED TO MAINTAIN LANE
52	OFF RD	RAN OFF ROAD

COLLISION TYPE CODE TRANSLATION LIST

COLL CODE	SHORT DESCRIPTION	LONG DESCRIPTION
&	OTH	MISCELLANEOUS
-	BACK	BACKING
0	PED	PEDESTRIAN
1	ANGL	ANGLE
2	HEAD	HEAD-ON
3	REAR	REAR-END
4	SS-M	SIDESWIPE - MEETING
5	SS-O	SIDESWIPE - OVERTAKING
6	TURN	TURNING MOVEMENT
7	PARK	PARKING MANEUVER
8	NCOL	NON-COLLISION
9	FIX	FIXED OBJECT OR OTHER OBJECT

CRASH TYPE CODE TRANSLATION LIST

CRASH TYPE	SHORT DESCRIPTION	LONG DESCRIPTION
&	OVERTURN	OVERTURNED
0	NON-COLL	OTHER NON-COLLISION
1	OTH RDWY	MOTOR VEHICLE ON OTHER ROADWAY
2	PRKD MV	PARKED MOTOR VEHICLE
3	PED	PEDESTRIAN
4	TRAIN	RAILWAY TRAIN
6	BIKE	PEDALCYCLIST
7	ANIMAL	ANIMAL
8	FIX OBJ	FIXED OBJECT
9	OTH OBJ	OTHER OBJECT
A	ANGL-STP	ENTERING AT ANGLE - ONE VEHICLE STOPPED
B	ANGL-OTH	ENTERING AT ANGLE - ALL OTHERS
C	S-STRGHT	FROM SAME DIRECTION - BOTH GOING STRAIGHT
D	S-1TURN	FROM SAME DIRECTION - ONE TURN, ONE STRAIGHT
E	S-1STOP	FROM SAME DIRECTION - ONE STOPPED
F	S-OTHER	FROM SAME DIRECTION-ALL OTHERS, INCLUDING PARKING
G	O-STRGHT	FROM OPPOSITE DIRECTION - BOTH GOING STRAIGHT
H	O-1 L-TURN	FROM OPPOSITE DIRECTION-ONE LEFT TURN, ONE STRAIGHT
I	O-1STOP	FROM OPPOSITE DIRECTION - ONE STOPPED
J	O-OTHER	FROM OPPOSITE DIRECTION-ALL OTHERS INCL. PARKING

DRIVER LICENSE CODE TRANSLATION LIST

LIC CODE	SHORT DESC	LONG DESCRIPTION
0	NONE	NOT LICENSED (HAD NEVER BEEN LICENSED)
1	OR-Y	VALID OREGON LICENSE
2	OTH-Y	VALID LICENSE, OTHER STATE OR COUNTRY
3	SUSP	SUSPENDED/REVOKED

DRIVER RESIDENCE CODE TRANSLATION LIST

RES CODE	SHORT DESC	LONG DESCRIPTION
1	OR<25	OREGON RESIDENT WITHIN 25 MILE OF HOME
2	OR>25	OREGON RESIDENT 25 OR MORE MILES FROM HOME
3	OR-?	OREGON RESIDENT - UNKNOWN DISTANCE FROM HOME
4	N-RES	NON-RESIDENT
9	UNK	UNKNOWN IF OREGON RESIDENT

ERROR CODE TRANSLATION LIST

ERROR CODE	SHORT DESCRIPTION	FULL DESCRIPTION
000	NONE	NO ERROR
001	WIDE TRN	WIDE TURN
002	CUT CORN	CUT CORNER ON TURN
003	FAIL TRN	FAILED TO OBEY MANDATORY TRAFFIC TURN SIGNAL, SIGN OR LANE MARKINGS
004	L IN TRF	LEFT TURN IN FRONT OF ONCOMING TRAFFIC
005	L PROHIB	LEFT TURN WHERE PROHIBITED
006	FRM WRNG	TURNED FROM WRONG LANE
007	TO WRONG	TURNED INTO WRONG LANE
008	ILLEG U	U-TURNED ILLEGALLY
009	IMP STOP	IMPROPERLY STOPPED IN TRAFFIC LANE
010	IMP SIG	IMPROPER SIGNAL OR FAILURE TO SIGNAL
011	IMP BACK	BACKING IMPROPERLY (NOT PARKING)
012	IMP PARK	IMPROPERLY PARKED
013	UNPARK	IMPROPER START LEAVING PARKED POSITION
014	IMP STRT	IMPROPER START FROM STOPPED POSITION
015	IMP LGHT	IMPROPER OR NO LIGHTS (VEHICLE IN TRAFFIC)
016	INATTENT	INATTENTION (FAILURE TO DIM LIGHTS PRIOR TO 4/1/97)
017	UNSF VEH	DRIVING UNSAFE VEHICLE (NO OTHER ERROR APPARENT)
018	OTH PARK	ENTERING/EXITING PARKED POSITION W/ INSUFFICIENT CLEARANCE; OTHER IMPROPER PARKING MANEUVER
019	DIS DRIV	DISREGARDED OTHER DRIVER'S SIGNAL
020	DIS SGNL	DISREGARDED TRAFFIC SIGNAL
021	RAN STOP	DISREGARDED STOP SIGN OR FLASHING RED
022	DIS SIGN	DISREGARDED WARNING SIGN, FLARES OR FLASHING AMBER
023	DIS OFCR	DISREGARDED POLICE OFFICER OR FLAGMAN
024	DIS EMER	DISREGARDED SIREN OR WARNING OF EMERGENCY VEHICLE
025	DIS RR	DISREGARDED RR SIGNAL, RR SIGN, OR RR FLAGMAN
026	REAR-END	FAILED TO AVOID STOPPED OR PARKED VEHICLE AHEAD OTHER THAN SCHOOL BUS
027	BIKE ROW	DID NOT HAVE RIGHT-OF-WAY OVER PEDALCYCLIST
028	NO ROW	DID NOT HAVE RIGHT-OF-WAY
029	PED ROW	FAILED TO YIELD RIGHT-OF-WAY TO PEDESTRIAN
030	PAS CURV	PASSING ON A CURVE
031	PAS WRNG	PASSING ON THE WRONG SIDE
032	PAS TANG	PASSING ON STRAIGHT ROAD UNDER UNSAFE CONDITIONS
033	PAS X-WK	PASSED VEHICLE STOPPED AT CROSSWALK FOR PEDESTRIAN
034	PAS INTR	PASSING AT INTERSECTION
035	PAS HILL	PASSING ON CREST OF HILL
036	N/PAS ZN	PASSING IN "NO PASSING" ZONE
037	PAS TRAF	PASSING IN FRONT OF ONCOMING TRAFFIC
038	CUT-IN	CUTTING IN (TWO LANES - TWO WAY ONLY)
039	WRNGSIDE	DRIVING ON WRONG SIDE OF THE ROAD (2-WAY UNDIVIDED ROADWAYS)
040	THRU MED	DRIVING THROUGH SAFETY ZONE OR OVER ISLAND
041	F/ST BUS	FAILED TO STOP FOR SCHOOL BUS

ERROR CODE TRANSLATION LIST

ERROR CODE	SHORT DESCRIPTION	FULL DESCRIPTION
042	F/SLO MV	FAILED TO DECREASE SPEED FOR SLOWER MOVING VEHICLE
043	TOO CLOSE	FOLLOWING TOO CLOSELY (MUST BE ON OFFICER'S REPORT)
044	STRDL LN	STRADDLING OR DRIVING ON WRONG LANES
045	IMP CHG	IMPROPER CHANGE OF TRAFFIC LANES
046	WRNG WAY	WRONG WAY ON ONE-WAY ROADWAY; WRONG SIDE DIVIDED ROAD
047	BASCRULE	DRIVING TOO FAST FOR CONDITIONS (NOT EXCEEDING POSTED SPEED)
048	OPN DOOR	OPENED DOOR INTO ADJACENT TRAFFIC LANE
049	IMPEDING	IMPEDING TRAFFIC
050	SPEED	DRIVING IN EXCESS OF POSTED SPEED
051	RECKLESS	RECKLESS DRIVING (PER PAR)
052	CARELESS	CARELESS DRIVING (PER PAR)
053	RACING	SPEED RACING (PER PAR)
054	X N/SGNL	CROSSING AT INTERSECTION, NO TRAFFIC SIGNAL PRESENT
055	X W/SGNL	CROSSING AT INTERSECTION, TRAFFIC SIGNAL PRESENT
056	DIAGONAL	CROSSING AT INTERSECTION - DIAGONALLY
057	BTWN INT	CROSSING BETWEEN INTERSECTIONS
059	W/TRAF-S	WALKING, RUNNING, RIDING, ETC., ON SHOULDER WITH TRAFFIC
060	A/TRAF-S	WALKING, RUNNING, RIDING, ETC., ON SHOULDER FACING TRAFFIC
061	W/TRAF-P	WALKING, RUNNING, RIDING, ETC., ON PAVEMENT WITH TRAFFIC
062	A/TRAF-P	WALKING, RUNNING, RIDING, ETC., ON PAVEMENT FACING TRAFFIC
063	PLAYINRD	PLAYING IN STREET OR ROAD
064	PUSH MV	PUSHING OR WORKING ON VEHICLE IN ROAD OR ON SHOULDER
065	WORK IN RD	WORKING IN ROADWAY OR ALONG SHOULDER
070	LAY ON RD	STANDING OR LYING IN ROADWAY
071	NM IMP USE	IMPROPER USE OF TRAFFIC LANE BY NON-MOTORIST
073	ELUDING	ELUDING / ATTEMPT TO ELUDE
079	F NEG CURV	FAILED TO NEGOTIATE A CURVE
080	FAIL LN	FAILED TO MAINTAIN LANE
081	OFF RD	RAN OFF ROAD
082	NO CLEAR	DRIVER MISJUDGED CLEARANCE
083	OVRSTEER	OVER-CORRECTING
084	NOT USED	CODE NOT IN USE
085	OVRLOAD	OVERLOADING OR IMPROPER LOADING OF VEHICLE WITH CARGO OR PASSENGERS
097	UNA DIS TC	UNABLE TO DETERMINE WHICH DRIVER DISREGARDED TRAFFIC CONTROL DEVICE

EVENT CODE TRANSLATION LIST

EVENT CODE	SHORT DESCRIPTION	LONG DESCRIPTION
001	FEL/JUMP	OCCUPANT FELL, JUMPED OR WAS EJECTED FROM MOVING VEHICLE
002	INTERFER	PASSENGER INTERFERED WITH DRIVER
003	BUG INTF	ANIMAL OR INSECT IN VEHICLE INTERFERED WITH DRIVER
004	INDRCT PED	PEDESTRIAN INDIRECTLY INVOLVED (NOT STRUCK)
005	SUB-PED	"SUB-PED": PEDESTRIAN INJURED SUBSEQUENT TO COLLISION, ETC.
006	INDRCT BIK	PEDALCYCLIST INDIRECTLY INVOLVED (NOT STRUCK)
007	HITCHIKR	HITCHHIKER (SOLICITING A RIDE)
008	PSNGR TOW	PASSENGER OR NON-MOTORIST BEING TOWED OR PUSHED ON CONVEYANCE
009	ON/OFF V	GETTING ON/OFF STOPPED/PARKED VEHICLE (OCCUPANTS ONLY; MUST HAVE PHYSICAL CONTACT W/ VEHIC
010	SUB OTRN	OVERTURNED AFTER FIRST HARMFUL EVENT
011	MV PUSHD	VEHICLE BEING PUSHED
012	MV TOWED	VEHICLE TOWED OR HAD BEEN TOWING ANOTHER VEHICLE
013	FORCED	VEHICLE FORCED BY IMPACT INTO ANOTHER VEHICLE, PEDALCYCLIST OR PEDESTRIAN
014	SET MOTN	VEHICLE SET IN MOTION BY NON-DRIVER (CHILD RELEASED BRAKES, ETC.)
015	RR ROW	AT OR ON RAILROAD RIGHT-OF-WAY (NOT LIGHT RAIL)
016	LT RL ROW	AT OR ON LIGHT-RAIL RIGHT-OF-WAY
017	RR HIT V	TRAIN STRUCK VEHICLE
018	V HIT RR	VEHICLE STRUCK TRAIN
019	HIT RR CAR	VEHICLE STRUCK RAILROAD CAR ON ROADWAY
020	JACKKNIFE	JACKKNIFE; TRAILER OR TOWED VEHICLE STRUCK TOWING VEHICLE
021	TRL OTRN	TRAILER OR TOWED VEHICLE OVERTURNED
022	CN BROKE	TRAILER CONNECTION BROKE
023	DETACH TRL	DETACHED TRAILING OBJECT STRUCK OTHER VEHICLE, NON-MOTORIST, OR OBJECT
024	V DOOR OPN	VEHICLE DOOR OPENED INTO ADJACENT TRAFFIC LANE
025	WHEELOFF	WHEEL CAME OFF
026	HOOD UP	HOOD FLEW UP
028	LOAD SHIFT	LOST LOAD, LOAD MOVED OR SHIFTED
029	TIREFAIL	TIRE FAILURE
030	PET	PET: CAT, DOG AND SIMILAR
031	LVSTOCK	STOCK: COW, CALF, BULL, STEER, SHEEP, ETC.
032	HORSE	HORSE, MULE, OR DONKEY
033	HRSE&RID	HORSE AND RIDER
034	GAME	WILD ANIMAL, GAME (INCLUDES BIRDS; NOT DEER OR ELK)
035	DEER ELK	DEER OR ELK, WAPITI
036	ANML VEH	ANIMAL-DRAWN VEHICLE
037	CULVERT	CULVERT, OPEN LOW OR HIGH MANHOLE
038	ATENUATN	IMPACT ATTENUATOR
039	PK METER	PARKING METER
040	CURB	CURB (ALSO NARROW SIDEWALKS ON BRIDGES)
041	JIGGLE	JIGGLE BAR OR TRAFFIC SNAKE FOR CHANNELIZATION
042	GDRL END	LEADING EDGE OF GUARDRAIL
043	GARDRAIL	GUARD RAIL (NOT METAL MEDIAN BARRIER)
044	BARRIER	MEDIAN BARRIER (RAISED OR METAL)
045	WALL	RETAINING WALL OR TUNNEL WALL
046	BR RAIL	BRIDGE RAILING OR PARAPET (ON BRIDGE OR APPROACH)
047	BR ABUTMNT	BRIDGE ABUTMENT (INCLUDED "APPROACH END" THRU 2013)
048	BR COLMN	BRIDGE PILLAR OR COLUMN
049	BR GIRDR	BRIDGE GIRDER (HORIZONTAL BRIDGE STRUCTURE OVERHEAD)
050	ISLAND	TRAFFIC RAISED ISLAND
051	GORE	GORE
052	POLE UNK	POLE - TYPE UNKNOWN
053	POLE UTL	POLE - POWER OR TELEPHONE
054	ST LIGHT	POLE - STREET LIGHT ONLY
055	TRF SGNL	POLE - TRAFFIC SIGNAL AND PED SIGNAL ONLY
056	SGN BRDG	POLE - SIGN BRIDGE
057	STOPSIGN	STOP OR YIELD SIGN
058	OTH SIGN	OTHER SIGN, INCLUDING STREET SIGNS
059	HYDRANT	HYDRANT

EVENT CODE TRANSLATION LIST

EVENT CODE	SHORT DESCRIPTION	LONG DESCRIPTION
060	MARKER	DELINEATOR OR MARKER (REFLECTOR POSTS)
061	MAILBOX	MAILBOX
062	TREE	TREE, STUMP OR SHRUBS
063	VEG OHED	TREE BRANCH OR OTHER VEGETATION OVERHEAD, ETC.
064	WIRE/CBL	WIRE OR CABLE ACROSS OR OVER THE ROAD
065	TEMP SGN	TEMPORARY SIGN OR BARRICADE IN ROAD, ETC.
066	PERM SGN	PERMANENT SIGN OR BARRICADE IN/OFF ROAD
067	SLIDE	SLIDES, FALLEN OR FALLING ROCKS
068	FRGN OBJ	FOREIGN OBSTRUCTION/DEBRIS IN ROAD (NOT GRAVEL)
069	EQP WORK	EQUIPMENT WORKING IN/OFF ROAD
070	OTH EQP	OTHER EQUIPMENT IN OR OFF ROAD (INCLUDES PARKED TRAILER, BOAT)
071	MAIN EQP	WRECKER, STREET SWEEPER, SNOW PLOW OR SANDING EQUIPMENT
072	OTHER WALL	ROCK, BRICK OR OTHER SOLID WALL
073	IRRGL PVMT	OTHER BUMP (NOT SPEED BUMP), POTHOLE OR PAVEMENT IRREGULARITY (PER PAR)
074	OVERHD OBJ	OTHER OVERHEAD OBJECT (HIGHWAY SIGN, SIGNAL HEAD, ETC.); NOT BRIDGE
075	CAVE IN	BRIDGE OR ROAD CAVE IN
076	HI WATER	HIGH WATER
077	SNO BANK	SNOW BANK
078	LO-HI EDGE	LOW OR HIGH SHOULDER AT PAVEMENT EDGE
079	DITCH	CUT SLOPE OR DITCH EMBANKMENT
080	OBJ FRM MV	STRUCK BY ROCK OR OTHER OBJECT SET IN MOTION BY OTHER VEHICLE (INCL. LOST LOADS)
081	FLY-OBJ	STRUCK BY ROCK OR OTHER MOVING OR FLYING OBJECT (NOT SET IN MOTION BY VEHICLE)
082	VEH HID	VEHICLE OBSCURED VIEW
083	VEG HID	VEGETATION OBSCURED VIEW
084	BLDG HID	VIEW OBSCURED BY FENCE, SIGN, PHONE BOOTH, ETC.
085	WIND GUST	WIND GUST
086	IMMERSED	VEHICLE IMMERSED IN BODY OF WATER
087	FIRE/EXP	FIRE OR EXPLOSION
088	FENC/BLD	FENCE OR BUILDING, ETC.
089	OTHR CRASH	CRASH RELATED TO ANOTHER SEPARATE CRASH
090	TO 1 SIDE	TWO-WAY TRAFFIC ON DIVIDED ROADWAY ALL ROUTED TO ONE SIDE
091	BUILDING	BUILDING OR OTHER STRUCTURE
092	PHANTOM	OTHER (PHANTOM) NON-CONTACT VEHICLE
093	CELL PHONE	CELL PHONE (ON PAR OR DRIVER IN USE)
094	VIOL GDL	TEENAGE DRIVER IN VIOLATION OF GRADUATED LICENSE PGM
095	GUY WIRE	GUY WIRE
096	BERM	BERM (EARTHEN OR GRAVEL MOUND)
097	GRAVEL	GRAVEL IN ROADWAY
098	ABR EDGE	ABRUPT EDGE
099	CELL WTNSD	CELL PHONE USE WITNESSED BY OTHER PARTICIPANT
100	UNK FIXD	FIXED OBJECT, UNKNOWN TYPE.
101	OTHER OBJ	NON-FIXED OBJECT, OTHER OR UNKNOWN TYPE
102	TEXTING	TEXTING
103	WZ WORKER	WORK ZONE WORKER
104	ON VEHICLE	PASSENGER RIDING ON VEHICLE EXTERIOR
105	PEDAL PSGR	PASSENGER RIDING ON PEDALCYCLE
106	MAN WHLCHR	PEDESTRIAN IN NON-MOTORIZED WHEELCHAIR
107	MTR WHLCHR	PEDESTRIAN IN MOTORIZED WHEELCHAIR
108	OFFICER	LAW ENFORCEMENT / POLICE OFFICER
109	SUB-BIKE	"SUB-BIKE": PEDALCYCLIST INJURED SUBSEQUENT TO COLLISION, ETC.
110	N-MTR	NON-MOTORIST STRUCK VEHICLE
111	S CAR VS V	STREET CAR/TROLLEY (ON RAILS OR OVERHEAD WIRE SYSTEM) STRUCK VEHICLE
112	V VS S CAR	VEHICLE STRUCK STREET CAR/TROLLEY (ON RAILS OR OVERHEAD WIRE SYSTEM)
113	S CAR ROW	AT OR ON STREET CAR OR TROLLEY RIGHT-OF-WAY
114	RR EQUIP	VEHICLE STRUCK RAILROAD EQUIPMENT (NOT TRAIN) ON TRACKS
115	DSTRCT GPS	DISTRACTED BY NAVIGATION SYSTEM OR GPS DEVICE
116	DSTRCT OTH	DISTRACTED BY OTHER ELECTRONIC DEVICE
117	RR GATE	RAIL CROSSING DROP-ARM GATE

EVENT CODE TRANSLATION LIST

EVENT CODE	SHORT DESCRIPTION	LONG DESCRIPTION
118	EXPNSN JNT	EXPANSION JOINT
119	JERSEY BAR	JERSEY BARRIER
120	WIRE BAR	WIRE OR CABLE MEDIAN BARRIER
121	FENCE	FENCE
123	OBJ IN VEH	LOOSE OBJECT IN VEHICLE STRUCK OCCUPANT
124	SLIPPERY	SLIDING OR SWERVING DUE TO WET, ICY, SLIPPERY OR LOOSE SURFACE (NOT GRAVEL)
125	SHLDR	SHOULDER GAVE WAY
126	BOULDER	ROCK(S), BOULDER (NOT GRAVEL; NOT ROCK SLIDE)
127	LAND SLIDE	ROCK SLIDE OR LAND SLIDE
128	CURVE INV	CURVE PRESENT AT CRASH LOCATION
129	HILL INV	VERTICAL GRADE / HILL PRESENT AT CRASH LOCATION
130	CURVE HID	VIEW OBSCURED BY CURVE
131	HILL HID	VIEW OBSCURED BY VERTICAL GRADE / HILL
132	WINDOW HID	VIEW OBSCURED BY VEHICLE WINDOW CONDITIONS
133	SPRAY HID	VIEW OBSCURED BY WATER SPRAY

FUNCTIONAL CLASSIFICATION TRANSLATION LIST

FUNC CLASS	DESCRIPTION
01	RURAL PRINCIPAL ARTERIAL - INTERSTATE
02	RURAL PRINCIPAL ARTERIAL - OTHER
06	RURAL MINOR ARTERIAL
07	RURAL MAJOR COLLECTOR
08	RURAL MINOR COLLECTOR
09	RURAL LOCAL
11	URBAN PRINCIPAL ARTERIAL - INTERSTATE
12	URBAN PRINCIPAL ARTERIAL - OTHER FREEWAYS AND EXP
14	URBAN PRINCIPAL ARTERIAL - OTHER
16	URBAN MINOR ARTERIAL
17	URBAN MAJOR COLLECTOR
18	URBAN MINOR COLLECTOR
19	URBAN LOCAL
78	UNKNOWN RURAL SYSTEM
79	UNKNOWN RURAL NON-SYSTEM
98	UNKNOWN URBAN SYSTEM
99	UNKNOWN URBAN NON-SYSTEM

HIGHWAY COMPONENT TRANSLATION LIST

CODE	DESCRIPTION
0	MAINLINE STATE HIGHWAY
1	COUPLET
3	FRONTAGE ROAD
6	CONNECTION
8	HIGHWAY - OTHER

INJURY SEVERITY CODE TRANSLATION LIST

CODE	SHORT DESC	LONG DESCRIPTION
1	KILL	FATAL INJURY
2	INJA	INCAPACITATING INJURY - BLEEDING, BROKEN BONES
3	INJB	NON-INCAPACITATING INJURY
4	INJC	POSSIBLE INJURY - COMPLAINT OF PAIN
5	PRI	DIED PRIOR TO CRASH
7	NO<5	NO INJURY - 0 TO 4 YEARS OF AGE

LIGHT CONDITION CODE TRANSLATION LIST

CODE	SHORT DESC	LONG DESCRIPTION
0	UNK	UNKNOWN
1	DAY	DAYLIGHT
2	DLIT	DARKNESS - WITH STREET LIGHTS
3	DARK	DARKNESS - NO STREET LIGHTS
4	DAWN	DAWN (TWILIGHT)
5	DUSK	DUSK (TWILIGHT)

MEDIAN TYPE CODE TRANSLATION LIST

CODE	SHORT DESC	LONG DESCRIPTION
0	NONE	NO MEDIAN
1	RSDMD	SOLID MEDIAN BARRIER
2	DIVMD	EARTH, GRASS OR PAVED MEDIAN

MILEAGE TYPE CODE TRANSLATION LIST

CODE	LONG DESCRIPTION
0	REGULAR MILEAGE
T	TEMPORARY
Y	SPUR
Z	OVERLAPPING

MOVEMENT TYPE CODE TRANSLATION LIST

CODE	SHORT DESC	LONG DESCRIPTION
0	UNK	UNKNOWN
1	STRGHT	STRAIGHT AHEAD
2	TURN-R	TURNING RIGHT
3	TURN-L	TURNING LEFT
4	U-TURN	MAKING A U-TURN
5	BACK	BACKING
6	STOP	STOPPED IN TRAFFIC
7	PRKD-P	PARKED - PROPERLY
8	PRKD-I	PARKED - IMPROPERLY

PARTICIPANT TYPE CODE TRANSLATION LIST

CODE	SHORT DESC	LONG DESCRIPTION
0	OCC	UNKNOWN OCCUPANT TYPE
1	DRVR	DRIVER
2	PSNG	PASSENGER
3	PED	PEDESTRIAN
4	CONV	PEDESTRIAN USING A PEDESTRIAN CONVEYANCE
5	PTOW	PEDESTRIAN TOWING OR TRAILERING AN OBJECT
6	BIKE	PEDALCYCLIST
7	BTOW	PEDALCYCLIST TOWING OR TRAILERING AN OBJECT
8	PRKD	OCCUPANT OF A PARKED MOTOR VEHICLE
9	UNK	UNKNOWN TYPE OF NON-MOTORIST

PEDESTRIAN LOCATION CODE TRANSLATION LIST

CODE	LONG DESCRIPTION
00	AT INTERSECTION - NOT IN ROADWAY
01	AT INTERSECTION - INSIDE CROSSWALK
02	AT INTERSECTION - IN ROADWAY, OUTSIDE CROSSWALK
03	AT INTERSECTION - IN ROADWAY, XWALK AVAIL UNKNWN
04	NOT AT INTERSECTION - IN ROADWAY
05	NOT AT INTERSECTION - ON SHOULDER
06	NOT AT INTERSECTION - ON MEDIAN
07	NOT AT INTERSECTION - WITHIN TRAFFIC RIGHT-OF-WAY
08	NOT AT INTERSECTION - IN BIKE PATH OR PARKING LANE
09	NOT-AT INTERSECTION - ON SIDEWALK
10	OUTSIDE TRAFFICWAY BOUNDARIES
13	AT INTERSECTION - IN BIKE LANE
14	NOT AT INTERSECTION - IN BIKE LANE
15	NOT AT INTERSECTION - INSIDE MID-BLOCK CROSSWALK
16	NOT AT INTERSECTION - IN PARKING LANE

TRAFFIC CONTROL DEVICE CODE TRANSLATION LIST

CODE	SHORT DESC	LONG DESCRIPTION
000	NONE	NO CONTROL
001	TRF SIGNAL	TRAFFIC SIGNALS
002	FLASHBCN-R	FLASHING BEACON - RED (STOP)
003	FLASHBCN-A	FLASHING BEACON - AMBER (SLOW)
004	STOP SIGN	STOP SIGN
005	SLOW SIGN	SLOW SIGN
006	REG-SIGN	REGULATORY SIGN
007	YIELD	YIELD SIGN
008	WARNING	WARNING SIGN
009	CURVE	CURVE SIGN
010	SCHL X-ING	SCHOOL CROSSING SIGN OR SPECIAL SIGNAL
011	OFCR/FLAG	POLICE OFFICER, FLAGMAN - SCHOOL PATROL
012	BRDG-GATE	BRIDGE GATE - BARRIER
013	TEMP-BARR	TEMPORARY BARRIER
014	NO-PASS-ZN	NO PASSING ZONE
015	ONE-WAY	ONE-WAY STREET
016	CHANNEL	CHANNELIZATION
017	MEDIAN BAR	MEDIAN BARRIER
018	PILOT CAR	PILOT CAR
019	SP PED SIG	SPECIAL PEDESTRIAN SIGNAL
020	X-BUCK	CROSSBUCK
021	THR-GN-SIG	THROUGH GREEN ARROW OR SIGNAL
022	L-GRN-SIG	LEFT TURN GREEN ARROW, LANE MARKINGS, OR SIGNAL
023	R-GRN-SIG	RIGHT TURN GREEN ARROW, LANE MARKINGS, OR SIGNAL
024	WIGWAG	WIGWAG OR FLASHING LIGHTS W/O DROP-ARM GATE
025	X-BUCK WRN	CROSSBUCK AND ADVANCE WARNING
026	WW W/ GATE	FLASHING LIGHTS WITH DROP-ARM GATES
027	OVRHD SGNL	SUPPLEMENTAL OVERHEAD SIGNAL (RR XING ONLY)
028	SP RR STOP	SPECIAL RR STOP SIGN
029	ILLUM GRD X	ILLUMINATED GRADE CROSSING
037	RAMP METER	METERED RAMPS
038	RUMBLE STR	RUMBLE STRIP
090	L-TURN REF	LEFT TURN REFUGE (WHEN REFUGE IS INVOLVED)
091	R-TURN ALL	RIGHT TURN AT ALL TIMES SIGN, ETC.
092	EMR SGN/FL	EMERGENCY SIGNS OR FLARES
093	ACCEL LANE	ACCELERATION OR DECELERATION LANES
094	R-TURN PRO	RIGHT TURN PROHIBITED ON RED AFTER STOPPING

ROAD CHARACTER CODE TRANSLATION LIST

CODE	SHORT DESC	LONG DESCRIPTION
0	UNK	UNKNOWN
1	INTER	INTERSECTION
2	ALLEY	DRIVEWAY OR ALLEY
3	STRGHT	STRAIGHT ROADWAY
4	TRANS	TRANSITION
5	CURVE	CURVE (HORIZONTAL CURVE)
6	OPENAC	OPEN ACCESS OR TURNOUT
7	GRADE	GRADE (VERTICAL CURVE)
8	BRIDGE	BRIDGE STRUCTURE
9	TUNNEL	TUNNEL

095 BUS STPSGN BUS STOP SIGN AND RED LIGHTS
099 UNKNOWN UNKNOWN OR NOT DEFINITE

VEHICLE TYPE CODE TRANSLATION LIST

CODE	SHORT DESC	LONG DESCRIPTION
00	PDO	NOT COLLECTED FOR PDO CRASHES
01	PSNGR CAR	PASSENGER CAR, PICKUP, LIGHT DELIVERY, ETC.
02	BOBTAIL	TRUCK TRACTOR WITH NO TRAILERS (BOBTAIL)
03	FARM TRCTR	FARM TRACTOR OR SELF-PROPELLED FARM EQUIPMENT
04	SEMI TOW	TRUCK TRACTOR WITH TRAILER/MOBILE HOME IN TOW
05	TRUCK	TRUCK WITH NON-DETACHABLE BED, PANEL, ETC.
06	MOPED	MOPED, MINIBIKE, SEATED MOTOR SCOOTER, MOTOR BIKE
07	SCHL BUS	SCHOOL BUS (INCLUDES VAN)
08	OTH BUS	OTHER BUS
09	MTRCYCLE	MOTORCYCLE, DIRT BIKE
10	OTHER	OTHER: FORKLIFT, BACKHOE, ETC.
11	MOTRHOME	MOTORHOME
12	TROLLEY	MOTORIZED STREET CAR/TROLLEY (NO RAILS/WIRES)
13	ATV	ATV
14	MTRSCTR	MOTORIZED SCOOTER (STANDING)
15	SNOWMOBILE	SNOWMOBILE
99	UNKNOWN	UNKNOWN VEHICLE TYPE

WEATHER CONDITION CODE TRANSLATION LIST

CODE	SHORT DESC	LONG DESCRIPTION
0	UNK	UNKNOWN
1	CLR	CLEAR
2	CLD	CLOUDY
3	RAIN	RAIN
4	SLT	SLEET
5	FOG	FOG
6	SNOW	SNOW
7	DUST	DUST
8	SMOK	SMOKE
9	ASH	ASH

OREGON DEPARTMENT OF TRANSPORTATION - TRANSPORTATION DEVELOPMENT DIVISION
 TRANSPORTATION DATA SECTION - CRASH ANALYSIS AND REPORTING UNIT
 CRASH SUMMARIES BY YEAR BY COLLISION TYPE

SW Boones Ferry Rd between SW Ibach St / SW Ibach Ct and SW Iowa Dr
 January 1, 2011 through December 31, 2015

COLLISION TYPE	FATAL CRASHES	NON- FATAL CRASHES	PROPERTY DAMAGE ONLY	TOTAL CRASHES	PEOPLE KILLED	PEOPLE INJURED	TRUCKS	DRY SURF	WET SURF	DAY	DARK	INTER- SECTION	INTER- SECTION RELATED	OFF- ROAD
YEAR: 2015														
REAR-END	0	3	1	4	0	3	0	4	0	4	0	0	0	0
2015 TOTAL	0	3	1	4	0	3	0	4	0	4	0	0	0	0
YEAR: 2014														
REAR-END	0	1	0	1	0	1	0	1	0	1	0	0	0	0
2014 TOTAL	0	1	0	1	0	1	0	1	0	1	0	0	0	0
YEAR: 2013														
REAR-END	0	0	2	2	0	0	0	1	1	1	1	0	0	0
TURNING MOVEMENTS	0	0	2	2	0	0	0	1	0	2	0	0	0	0
2013 TOTAL	0	0	4	4	0	0	0	2	1	3	1	0	0	0
YEAR: 2012														
REAR-END	0	0	1	1	0	0	0	0	1	1	0	0	0	0
2012 TOTAL	0	0	1	1	0	0	0	0	1	1	0	0	0	0
YEAR: 2011														
REAR-END	0	1	0	1	0	1	0	1	0	1	0	0	1	0
2011 TOTAL	0	1	0	1	0	1	0	1	0	1	0	0	1	0
FINAL TOTAL	0	5	6	11	0	5	0	8	2	10	1	0	1	0

Disclaimer: A higher number of crashes may be reported as of 2011 compared to prior years. This does not reflect an increase in annual crashes. The higher numbers result from a change to an internal departmental process that allows the Crash Analysis and Reporting Unit to add previously unavailable, non-fatal crash reports to the annual data file. Please be aware of this change when comparing pre-2011 crash statistics.

ACTION CODE TRANSLATION LIST

ACTION CODE	SHORT DESCRIPTION	LONG DESCRIPTION
000	NONE	NO ACTION OR NON-WARRANTED
001	SKIDDED	SKIDDED
002	ON/OFF V	GETTING ON OR OFF STOPPED OR PARKED VEHICLE
003	LOAD OVR	OVERHANGING LOAD STRUCK ANOTHER VEHICLE, ETC.
006	SLOW DN	SLOWED DOWN
007	AVOIDING	AVOIDING MANEUVER
008	PAR PARK	PARALLEL PARKING
009	ANG PARK	ANGLE PARKING
010	INTERFERE	PASSENGER INTERFERING WITH DRIVER
011	STOPPED	STOPPED IN TRAFFIC NOT WAITING TO MAKE A LEFT TURN
012	STP/L TRN	STOPPED BECAUSE OF LEFT TURN SIGNAL OR WAITING, ETC.
013	STP TURN	STOPPED WHILE EXECUTING A TURN
014	EMR V PKD	EMERGENCY VEHICLE LEGALLY PARKED IN THE ROADWAY
015	GO A/STOP	PROCEED AFTER STOPPING FOR A STOP SIGN/FLASHING RED.
016	TRN A/RED	TURNED ON RED AFTER STOPPING
017	LOSTCTRL	LOST CONTROL OF VEHICLE
018	EXIT DWY	ENTERING STREET OR HIGHWAY FROM ALLEY OR DRIVEWAY
019	ENTR DWY	ENTERING ALLEY OR DRIVEWAY FROM STREET OR HIGHWAY
020	STR ENTR	BEFORE ENTERING ROADWAY, STRUCK PEDESTRIAN, ETC. ON SIDEWALK OR SHOULDER
021	NO DRVR	CAR RAN AWAY - NO DRIVER
022	PREV COL	STRUCK, OR WAS STRUCK BY, VEHICLE OR PEDESTRIAN IN PRIOR COLLISION BEFORE ACC. STABILIZED
023	STALLED	VEHICLE STALLED OR DISABLED
024	DRVR DEAD	DEAD BY UNASSOCIATED CAUSE
025	FATIGUE	FATIGUED, SLEEPY, ASLEEP
026	SUN	DRIVER BLINDED BY SUN
027	HDLGHTS	DRIVER BLINDED BY HEADLIGHTS
028	ILLNESS	PHYSICALLY ILL
029	THRU MED	VEHICLE CROSSED, PLUNGED OVER, OR THROUGH MEDIAN BARRIER
030	PURSUIT	PURSUIING OR ATTEMPTING TO STOP A VEHICLE
031	PASSING	PASSING SITUATION
032	PRKOFFRD	VEHICLE PARKED BEYOND CURB OR SHOULDER
033	CROS MED	VEHICLE CROSSED EARTH OR GRASS MEDIAN
034	X N/SGNL	CROSSING AT INTERSECTION - NO TRAFFIC SIGNAL PRESENT
035	X W/ SGNL	CROSSING AT INTERSECTION - TRAFFIC SIGNAL PRESENT
036	DIAGONAL	CROSSING AT INTERSECTION - DIAGONALLY
037	BTWN INT	CROSSING BETWEEN INTERSECTIONS
038	DISTRACT	DRIVER'S ATTENTION DISTRACTED
039	W/TRAF-S	WALKING, RUNNING, RIDING, ETC., ON SHOULDER WITH TRAFFIC
040	A/TRAF-S	WALKING, RUNNING, RIDING, ETC., ON SHOULDER FACING TRAFFIC
041	W/TRAF-P	WALKING, RUNNING, RIDING, ETC., ON PAVEMENT WITH TRAFFIC
042	A/TRAF-P	WALKING, RUNNING, RIDING, ETC., ON PAVEMENT FACING TRAFFIC
043	PLAYINRD	PLAYING IN STREET OR ROAD
044	PUSH MV	PUSHING OR WORKING ON VEHICLE IN ROAD OR ON SHOULDER
045	WORK ON	WORKING IN ROADWAY OR ALONG SHOULDER
046	W/ TRAFIC	NON-MOTORIST WALKING, RUNNING, RIDING, ETC. WITH TRAFFIC
047	A/ TRAFIC	NON-MOTORIST WALKING, RUNNING, RIDING, ETC. FACING TRAFFIC
050	LAY ON RD	STANDING OR LYING IN ROADWAY
051	ENT OFFRD	ENTERING / STARTING IN TRAFFIC LANE FROM OFF ROAD
052	MERGING	MERGING
055	SPRAY	BLINDED BY WATER SPRAY

ACTION CODE TRANSLATION LIST

ACTION CODE	SHORT DESCRIPTION	LONG DESCRIPTION
088	OTHER	OTHER ACTION
099	UNK	UNKNOWN ACTION

CAUSE CODE TRANSLATION LIST

CAUSE CODE	SHORT DESCRIPTION	LONG DESCRIPTION
00	NO CODE	NO CAUSE ASSOCIATED AT THIS LEVEL
01	TOO-FAST	TOO FAST FOR CONDITIONS (NOT EXCEED POSTED SPEED)
02	NO-YIELD	DID NOT YIELD RIGHT-OF-WAY
03	PAS-STOP	PASSED STOP SIGN OR RED FLASHER
04	DIS SIG	DISREGARDED TRAFFIC SIGNAL
05	LEFT-CTR	DROVE LEFT OF CENTER ON TWO-WAY ROAD; STRADDLING
06	IMP-OVER	IMPROPER OVERTAKING
07	TOO-CLOS	FOLLOWED TOO CLOSELY
08	IMP-TURN	MADE IMPROPER TURN
09	DRINKING	ALCOHOL OR DRUG INVOLVED
10	OTHR-IMP	OTHER IMPROPER DRIVING
11	MECH-DEF	MECHANICAL DEFECT
12	OTHER	OTHER (NOT IMPROPER DRIVING)
13	IMP LN C	IMPROPER CHANGE OF TRAFFIC LANES
14	DIS TCD	DISREGARDED OTHER TRAFFIC CONTROL DEVICE
15	WRNG WAY	WRONG WAY ON ONE-WAY ROAD; WRONG SIDE DIVIDED ROAD
16	FATIGUE	DRIVER DROWSY/FATIGUED/SLEEPY
17	ILLNESS	PHYSICAL ILLNESS
18	IN RDWY	NON-MOTORIST ILLEGALLY IN ROADWAY
19	NT VISBL	NON-MOTORIST NOT VISIBLE; NON-REFLECTIVE CLOTHING
20	IMP PKNG	VEHICLE IMPROPERLY PARKED
21	DEF STER	DEFECTIVE STEERING MECHANISM
22	DEF BRKE	INADEQUATE OR NO BRAKES
24	LOADSHFT	VEHICLE LOST LOAD OR LOAD SHIFTED
25	TIREFAIL	TIRE FAILURE
26	PHANTOM	PHANTOM / NON-CONTACT VEHICLE
27	INATTENT	INATTENTION
28	NM INATT	NON-MOTORIST INATTENTION
29	F AVOID	FAILED TO AVOID VEHICLE AHEAD
30	SPEED	DRIVING IN EXCESS OF POSTED SPEED
31	RACING	SPEED RACING (PER PAR)
32	CARELESS	CARELESS DRIVING (PER PAR)
33	RECKLESS	RECKLESS DRIVING (PER PAR)
34	AGGRESV	AGGRESSIVE DRIVING (PER PAR)
35	RD RAGE	ROAD RAGE (PER PAR)
40	VIEW OBS	VIEW OBSCURED
50	USED MDN	IMPROPER USE OF MEDIAN OR SHOULDER
51	FAIL LN	FAILED TO MAINTAIN LANE
52	OFF RD	RAN OFF ROAD

COLLISION TYPE CODE TRANSLATION LIST

COLL CODE	SHORT DESCRIPTION	LONG DESCRIPTION
&	OTH	MISCELLANEOUS
-	BACK	BACKING
0	PED	PEDESTRIAN
1	ANGL	ANGLE
2	HEAD	HEAD-ON
3	REAR	REAR-END
4	SS-M	SIDESWIPE - MEETING
5	SS-O	SIDESWIPE - OVERTAKING
6	TURN	TURNING MOVEMENT
7	PARK	PARKING MANEUVER
8	NCOL	NON-COLLISION
9	FIX	FIXED OBJECT OR OTHER OBJECT

CRASH TYPE CODE TRANSLATION LIST

CRASH TYPE	SHORT DESCRIPTION	LONG DESCRIPTION
&	OVERTURN	OVERTURNED
0	NON-COLL	OTHER NON-COLLISION
1	OTH RDWY	MOTOR VEHICLE ON OTHER ROADWAY
2	PRKD MV	PARKED MOTOR VEHICLE
3	PED	PEDESTRIAN
4	TRAIN	RAILWAY TRAIN
6	BIKE	PEDALCYCLIST
7	ANIMAL	ANIMAL
8	FIX OBJ	FIXED OBJECT
9	OTH OBJ	OTHER OBJECT
A	ANGL-STP	ENTERING AT ANGLE - ONE VEHICLE STOPPED
B	ANGL-OTH	ENTERING AT ANGLE - ALL OTHERS
C	S-STRGHT	FROM SAME DIRECTION - BOTH GOING STRAIGHT
D	S-1TURN	FROM SAME DIRECTION - ONE TURN, ONE STRAIGHT
E	S-1STOP	FROM SAME DIRECTION - ONE STOPPED
F	S-OTHER	FROM SAME DIRECTION-ALL OTHERS, INCLUDING PARKING
G	O-STRGHT	FROM OPPOSITE DIRECTION - BOTH GOING STRAIGHT
H	O-1 L-TURN	FROM OPPOSITE DIRECTION-ONE LEFT TURN, ONE STRAIGHT
I	O-1STOP	FROM OPPOSITE DIRECTION - ONE STOPPED
J	O-OTHER	FROM OPPOSITE DIRECTION-ALL OTHERS INCL. PARKING

DRIVER LICENSE CODE TRANSLATION LIST

LIC CODE	SHORT DESC	LONG DESCRIPTION
0	NONE	NOT LICENSED (HAD NEVER BEEN LICENSED)
1	OR-Y	VALID OREGON LICENSE
2	OTH-Y	VALID LICENSE, OTHER STATE OR COUNTRY
3	SUSP	SUSPENDED/REVOKED

DRIVER RESIDENCE CODE TRANSLATION LIST

RES CODE	SHORT DESC	LONG DESCRIPTION
1	OR<25	OREGON RESIDENT WITHIN 25 MILE OF HOME
2	OR>25	OREGON RESIDENT 25 OR MORE MILES FROM HOME
3	OR-?	OREGON RESIDENT - UNKNOWN DISTANCE FROM HOME
4	N-RES	NON-RESIDENT
9	UNK	UNKNOWN IF OREGON RESIDENT

ERROR CODE TRANSLATION LIST

ERROR CODE	SHORT DESCRIPTION	FULL DESCRIPTION
000	NONE	NO ERROR
001	WIDE TRN	WIDE TURN
002	CUT CORN	CUT CORNER ON TURN
003	FAIL TRN	FAILED TO OBEY MANDATORY TRAFFIC TURN SIGNAL, SIGN OR LANE MARKINGS
004	L IN TRF	LEFT TURN IN FRONT OF ONCOMING TRAFFIC
005	L PROHIB	LEFT TURN WHERE PROHIBITED
006	FRM WRNG	TURNED FROM WRONG LANE
007	TO WRONG	TURNED INTO WRONG LANE
008	ILLEG U	U-TURNED ILLEGALLY
009	IMP STOP	IMPROPERLY STOPPED IN TRAFFIC LANE
010	IMP SIG	IMPROPER SIGNAL OR FAILURE TO SIGNAL
011	IMP BACK	BACKING IMPROPERLY (NOT PARKING)
012	IMP PARK	IMPROPERLY PARKED
013	UNPARK	IMPROPER START LEAVING PARKED POSITION
014	IMP STRT	IMPROPER START FROM STOPPED POSITION
015	IMP LGHT	IMPROPER OR NO LIGHTS (VEHICLE IN TRAFFIC)
016	INATTENT	INATTENTION (FAILURE TO DIM LIGHTS PRIOR TO 4/1/97)
017	UNSF VEH	DRIVING UNSAFE VEHICLE (NO OTHER ERROR APPARENT)
018	OTH PARK	ENTERING/EXITING PARKED POSITION W/ INSUFFICIENT CLEARANCE; OTHER IMPROPER PARKING MANEUVER
019	DIS DRIV	DISREGARDED OTHER DRIVER'S SIGNAL
020	DIS SGNL	DISREGARDED TRAFFIC SIGNAL
021	RAN STOP	DISREGARDED STOP SIGN OR FLASHING RED
022	DIS SIGN	DISREGARDED WARNING SIGN, FLARES OR FLASHING AMBER
023	DIS OFCR	DISREGARDED POLICE OFFICER OR FLAGMAN
024	DIS EMER	DISREGARDED SIREN OR WARNING OF EMERGENCY VEHICLE
025	DIS RR	DISREGARDED RR SIGNAL, RR SIGN, OR RR FLAGMAN
026	REAR-END	FAILED TO AVOID STOPPED OR PARKED VEHICLE AHEAD OTHER THAN SCHOOL BUS
027	BIKE ROW	DID NOT HAVE RIGHT-OF-WAY OVER PEDALCYCLIST
028	NO ROW	DID NOT HAVE RIGHT-OF-WAY
029	PED ROW	FAILED TO YIELD RIGHT-OF-WAY TO PEDESTRIAN
030	PAS CURV	PASSING ON A CURVE
031	PAS WRNG	PASSING ON THE WRONG SIDE
032	PAS TANG	PASSING ON STRAIGHT ROAD UNDER UNSAFE CONDITIONS
033	PAS X-WK	PASSED VEHICLE STOPPED AT CROSSWALK FOR PEDESTRIAN
034	PAS INTR	PASSING AT INTERSECTION
035	PAS HILL	PASSING ON CREST OF HILL
036	N/PAS ZN	PASSING IN "NO PASSING" ZONE
037	PAS TRAF	PASSING IN FRONT OF ONCOMING TRAFFIC
038	CUT-IN	CUTTING IN (TWO LANES - TWO WAY ONLY)
039	WRNGSIDE	DRIVING ON WRONG SIDE OF THE ROAD (2-WAY UNDIVIDED ROADWAYS)
040	THRU MED	DRIVING THROUGH SAFETY ZONE OR OVER ISLAND
041	F/ST BUS	FAILED TO STOP FOR SCHOOL BUS

ERROR CODE TRANSLATION LIST

ERROR CODE	SHORT DESCRIPTION	FULL DESCRIPTION
042	F/SLO MV	FAILED TO DECREASE SPEED FOR SLOWER MOVING VEHICLE
043	TOO CLOSE	FOLLOWING TOO CLOSELY (MUST BE ON OFFICER'S REPORT)
044	STRDL LN	STRADDLING OR DRIVING ON WRONG LANES
045	IMP CHG	IMPROPER CHANGE OF TRAFFIC LANES
046	WRNG WAY	WRONG WAY ON ONE-WAY ROADWAY; WRONG SIDE DIVIDED ROAD
047	BASCRULE	DRIVING TOO FAST FOR CONDITIONS (NOT EXCEEDING POSTED SPEED)
048	OPN DOOR	OPENED DOOR INTO ADJACENT TRAFFIC LANE
049	IMPEDING	IMPEDING TRAFFIC
050	SPEED	DRIVING IN EXCESS OF POSTED SPEED
051	RECKLESS	RECKLESS DRIVING (PER PAR)
052	CARELESS	CARELESS DRIVING (PER PAR)
053	RACING	SPEED RACING (PER PAR)
054	X N/SGNL	CROSSING AT INTERSECTION, NO TRAFFIC SIGNAL PRESENT
055	X W/SGNL	CROSSING AT INTERSECTION, TRAFFIC SIGNAL PRESENT
056	DIAGONAL	CROSSING AT INTERSECTION - DIAGONALLY
057	BTWN INT	CROSSING BETWEEN INTERSECTIONS
059	W/TRAF-S	WALKING, RUNNING, RIDING, ETC., ON SHOULDER WITH TRAFFIC
060	A/TRAF-S	WALKING, RUNNING, RIDING, ETC., ON SHOULDER FACING TRAFFIC
061	W/TRAF-P	WALKING, RUNNING, RIDING, ETC., ON PAVEMENT WITH TRAFFIC
062	A/TRAF-P	WALKING, RUNNING, RIDING, ETC., ON PAVEMENT FACING TRAFFIC
063	PLAYINRD	PLAYING IN STREET OR ROAD
064	PUSH MV	PUSHING OR WORKING ON VEHICLE IN ROAD OR ON SHOULDER
065	WORK IN RD	WORKING IN ROADWAY OR ALONG SHOULDER
070	LAY ON RD	STANDING OR LYING IN ROADWAY
071	NM IMP USE	IMPROPER USE OF TRAFFIC LANE BY NON-MOTORIST
073	ELUDING	ELUDING / ATTEMPT TO ELUDE
079	F NEG CURV	FAILED TO NEGOTIATE A CURVE
080	FAIL LN	FAILED TO MAINTAIN LANE
081	OFF RD	RAN OFF ROAD
082	NO CLEAR	DRIVER MISJUDGED CLEARANCE
083	OVRSTEER	OVER-CORRECTING
084	NOT USED	CODE NOT IN USE
085	OVRLOAD	OVERLOADING OR IMPROPER LOADING OF VEHICLE WITH CARGO OR PASSENGERS
097	UNA DIS TC	UNABLE TO DETERMINE WHICH DRIVER DISREGARDED TRAFFIC CONTROL DEVICE

EVENT CODE TRANSLATION LIST

EVENT CODE	SHORT DESCRIPTION	LONG DESCRIPTION
001	FEL/JUMP	OCCUPANT FELL, JUMPED OR WAS EJECTED FROM MOVING VEHICLE
002	INTERFER	PASSENGER INTERFERED WITH DRIVER
003	BUG INTF	ANIMAL OR INSECT IN VEHICLE INTERFERED WITH DRIVER
004	INDRCT PED	PEDESTRIAN INDIRECTLY INVOLVED (NOT STRUCK)
005	SUB-PED	"SUB-PED": PEDESTRIAN INJURED SUBSEQUENT TO COLLISION, ETC.
006	INDRCT BIK	PEDALCYCLIST INDIRECTLY INVOLVED (NOT STRUCK)
007	HITCHIKR	HITCHHIKER (SOLICITING A RIDE)
008	PSNGR TOW	PASSENGER OR NON-MOTORIST BEING TOWED OR PUSHED ON CONVEYANCE
009	ON/OFF V	GETTING ON/OFF STOPPED/PARKED VEHICLE (OCCUPANTS ONLY; MUST HAVE PHYSICAL CONTACT W/ VEHIC
010	SUB OTRN	OVERTURNED AFTER FIRST HARMFUL EVENT
011	MV PUSHD	VEHICLE BEING PUSHED
012	MV TOWED	VEHICLE TOWED OR HAD BEEN TOWING ANOTHER VEHICLE
013	FORCED	VEHICLE FORCED BY IMPACT INTO ANOTHER VEHICLE, PEDALCYCLIST OR PEDESTRIAN
014	SET MOTN	VEHICLE SET IN MOTION BY NON-DRIVER (CHILD RELEASED BRAKES, ETC.)
015	RR ROW	AT OR ON RAILROAD RIGHT-OF-WAY (NOT LIGHT RAIL)
016	LT RL ROW	AT OR ON LIGHT-RAIL RIGHT-OF-WAY
017	RR HIT V	TRAIN STRUCK VEHICLE
018	V HIT RR	VEHICLE STRUCK TRAIN
019	HIT RR CAR	VEHICLE STRUCK RAILROAD CAR ON ROADWAY
020	JACKKNIFE	JACKKNIFE; TRAILER OR TOWED VEHICLE STRUCK TOWING VEHICLE
021	TRL OTRN	TRAILER OR TOWED VEHICLE OVERTURNED
022	CN BROKE	TRAILER CONNECTION BROKE
023	DETACH TRL	DETACHED TRAILING OBJECT STRUCK OTHER VEHICLE, NON-MOTORIST, OR OBJECT
024	V DOOR OPN	VEHICLE DOOR OPENED INTO ADJACENT TRAFFIC LANE
025	WHEELOFF	WHEEL CAME OFF
026	HOOD UP	HOOD FLEW UP
028	LOAD SHIFT	LOST LOAD, LOAD MOVED OR SHIFTED
029	TIREFAIL	TIRE FAILURE
030	PET	PET: CAT, DOG AND SIMILAR
031	LVSTOCK	STOCK: COW, CALF, BULL, STEER, SHEEP, ETC.
032	HORSE	HORSE, MULE, OR DONKEY
033	HRSE&RID	HORSE AND RIDER
034	GAME	WILD ANIMAL, GAME (INCLUDES BIRDS; NOT DEER OR ELK)
035	DEER ELK	DEER OR ELK, WAPITI
036	ANML VEH	ANIMAL-DRAWN VEHICLE
037	CULVERT	CULVERT, OPEN LOW OR HIGH MANHOLE
038	ATENUATN	IMPACT ATTENUATOR
039	PK METER	PARKING METER
040	CURB	CURB (ALSO NARROW SIDEWALKS ON BRIDGES)
041	JIGGLE	JIGGLE BAR OR TRAFFIC SNAKE FOR CHANNELIZATION
042	GDRL END	LEADING EDGE OF GUARDRAIL
043	GARDRAIL	GUARD RAIL (NOT METAL MEDIAN BARRIER)
044	BARRIER	MEDIAN BARRIER (RAISED OR METAL)
045	WALL	RETAINING WALL OR TUNNEL WALL
046	BR RAIL	BRIDGE RAILING OR PARAPET (ON BRIDGE OR APPROACH)
047	BR ABUTMNT	BRIDGE ABUTMENT (INCLUDED "APPROACH END" THRU 2013)
048	BR COLMN	BRIDGE PILLAR OR COLUMN
049	BR GIRDR	BRIDGE GIRDER (HORIZONTAL BRIDGE STRUCTURE OVERHEAD)
050	ISLAND	TRAFFIC RAISED ISLAND
051	GORE	GORE
052	POLE UNK	POLE - TYPE UNKNOWN
053	POLE UTL	POLE - POWER OR TELEPHONE
054	ST LIGHT	POLE - STREET LIGHT ONLY
055	TRF SGNL	POLE - TRAFFIC SIGNAL AND PED SIGNAL ONLY
056	SGN BRDG	POLE - SIGN BRIDGE
057	STOPSIGN	STOP OR YIELD SIGN
058	OTH SIGN	OTHER SIGN, INCLUDING STREET SIGNS
059	HYDRANT	HYDRANT

EVENT CODE TRANSLATION LIST

EVENT CODE	SHORT DESCRIPTION	LONG DESCRIPTION
060	MARKER	DELINEATOR OR MARKER (REFLECTOR POSTS)
061	MAILBOX	MAILBOX
062	TREE	TREE, STUMP OR SHRUBS
063	VEG OHED	TREE BRANCH OR OTHER VEGETATION OVERHEAD, ETC.
064	WIRE/CBL	WIRE OR CABLE ACROSS OR OVER THE ROAD
065	TEMP SGN	TEMPORARY SIGN OR BARRICADE IN ROAD, ETC.
066	PERM SGN	PERMANENT SIGN OR BARRICADE IN/OFF ROAD
067	SLIDE	SLIDES, FALLEN OR FALLING ROCKS
068	FRGN OBJ	FOREIGN OBSTRUCTION/DEBRIS IN ROAD (NOT GRAVEL)
069	EQP WORK	EQUIPMENT WORKING IN/OFF ROAD
070	OTH EQP	OTHER EQUIPMENT IN OR OFF ROAD (INCLUDES PARKED TRAILER, BOAT)
071	MAIN EQP	WRECKER, STREET SWEEPER, SNOW PLOW OR SANDING EQUIPMENT
072	OTHER WALL	ROCK, BRICK OR OTHER SOLID WALL
073	IRRGL PVMT	OTHER BUMP (NOT SPEED BUMP), POTHOLE OR PAVEMENT IRREGULARITY (PER PAR)
074	OVERHD OBJ	OTHER OVERHEAD OBJECT (HIGHWAY SIGN, SIGNAL HEAD, ETC.); NOT BRIDGE
075	CAVE IN	BRIDGE OR ROAD CAVE IN
076	HI WATER	HIGH WATER
077	SNO BANK	SNOW BANK
078	LO-HI EDGE	LOW OR HIGH SHOULDER AT PAVEMENT EDGE
079	DITCH	CUT SLOPE OR DITCH EMBANKMENT
080	OBJ FRM MV	STRUCK BY ROCK OR OTHER OBJECT SET IN MOTION BY OTHER VEHICLE (INCL. LOST LOADS)
081	FLY-OBJ	STRUCK BY ROCK OR OTHER MOVING OR FLYING OBJECT (NOT SET IN MOTION BY VEHICLE)
082	VEH HID	VEHICLE OBSCURED VIEW
083	VEG HID	VEGETATION OBSCURED VIEW
084	BLDG HID	VIEW OBSCURED BY FENCE, SIGN, PHONE BOOTH, ETC.
085	WIND GUST	WIND GUST
086	IMMERSED	VEHICLE IMMERSED IN BODY OF WATER
087	FIRE/EXP	FIRE OR EXPLOSION
088	FENC/BLD	FENCE OR BUILDING, ETC.
089	OTHR CRASH	CRASH RELATED TO ANOTHER SEPARATE CRASH
090	TO 1 SIDE	TWO-WAY TRAFFIC ON DIVIDED ROADWAY ALL ROUTED TO ONE SIDE
091	BUILDING	BUILDING OR OTHER STRUCTURE
092	PHANTOM	OTHER (PHANTOM) NON-CONTACT VEHICLE
093	CELL PHONE	CELL PHONE (ON PAR OR DRIVER IN USE)
094	VIOL GDL	TEENAGE DRIVER IN VIOLATION OF GRADUATED LICENSE PGM
095	GUY WIRE	GUY WIRE
096	BERM	BERM (EARTHEN OR GRAVEL MOUND)
097	GRAVEL	GRAVEL IN ROADWAY
098	ABR EDGE	ABRUPT EDGE
099	CELL WTNSD	CELL PHONE USE WITNESSED BY OTHER PARTICIPANT
100	UNK FIXD	FIXED OBJECT, UNKNOWN TYPE.
101	OTHER OBJ	NON-FIXED OBJECT, OTHER OR UNKNOWN TYPE
102	TEXTING	TEXTING
103	WZ WORKER	WORK ZONE WORKER
104	ON VEHICLE	PASSENGER RIDING ON VEHICLE EXTERIOR
105	PEDAL PSGR	PASSENGER RIDING ON PEDALCYCLE
106	MAN WHLCHR	PEDESTRIAN IN NON-MOTORIZED WHEELCHAIR
107	MTR WHLCHR	PEDESTRIAN IN MOTORIZED WHEELCHAIR
108	OFFICER	LAW ENFORCEMENT / POLICE OFFICER
109	SUB-BIKE	"SUB-BIKE": PEDALCYCLIST INJURED SUBSEQUENT TO COLLISION, ETC.
110	N-MTR	NON-MOTORIST STRUCK VEHICLE
111	S CAR VS V	STREET CAR/TROLLEY (ON RAILS OR OVERHEAD WIRE SYSTEM) STRUCK VEHICLE
112	V VS S CAR	VEHICLE STRUCK STREET CAR/TROLLEY (ON RAILS OR OVERHEAD WIRE SYSTEM)
113	S CAR ROW	AT OR ON STREET CAR OR TROLLEY RIGHT-OF-WAY
114	RR EQUIP	VEHICLE STRUCK RAILROAD EQUIPMENT (NOT TRAIN) ON TRACKS
115	DSTRCT GPS	DISTRACTED BY NAVIGATION SYSTEM OR GPS DEVICE
116	DSTRCT OTH	DISTRACTED BY OTHER ELECTRONIC DEVICE
117	RR GATE	RAIL CROSSING DROP-ARM GATE

EVENT CODE TRANSLATION LIST

EVENT CODE	SHORT DESCRIPTION	LONG DESCRIPTION
118	EXPNSN JNT	EXPANSION JOINT
119	JERSEY BAR	JERSEY BARRIER
120	WIRE BAR	WIRE OR CABLE MEDIAN BARRIER
121	FENCE	FENCE
123	OBJ IN VEH	LOOSE OBJECT IN VEHICLE STRUCK OCCUPANT
124	SLIPPERY	SLIDING OR SWERVING DUE TO WET, ICY, SLIPPERY OR LOOSE SURFACE (NOT GRAVEL)
125	SHLDR	SHOULDER GAVE WAY
126	BOULDER	ROCK(S), BOULDER (NOT GRAVEL; NOT ROCK SLIDE)
127	LAND SLIDE	ROCK SLIDE OR LAND SLIDE
128	CURVE INV	CURVE PRESENT AT CRASH LOCATION
129	HILL INV	VERTICAL GRADE / HILL PRESENT AT CRASH LOCATION
130	CURVE HID	VIEW OBSCURED BY CURVE
131	HILL HID	VIEW OBSCURED BY VERTICAL GRADE / HILL
132	WINDOW HID	VIEW OBSCURED BY VEHICLE WINDOW CONDITIONS
133	SPRAY HID	VIEW OBSCURED BY WATER SPRAY

FUNCTIONAL CLASSIFICATION TRANSLATION LIST

FUNC CLASS	DESCRIPTION
01	RURAL PRINCIPAL ARTERIAL - INTERSTATE
02	RURAL PRINCIPAL ARTERIAL - OTHER
06	RURAL MINOR ARTERIAL
07	RURAL MAJOR COLLECTOR
08	RURAL MINOR COLLECTOR
09	RURAL LOCAL
11	URBAN PRINCIPAL ARTERIAL - INTERSTATE
12	URBAN PRINCIPAL ARTERIAL - OTHER FREEWAYS AND EXP
14	URBAN PRINCIPAL ARTERIAL - OTHER
16	URBAN MINOR ARTERIAL
17	URBAN MAJOR COLLECTOR
18	URBAN MINOR COLLECTOR
19	URBAN LOCAL
78	UNKNOWN RURAL SYSTEM
79	UNKNOWN RURAL NON-SYSTEM
98	UNKNOWN URBAN SYSTEM
99	UNKNOWN URBAN NON-SYSTEM

HIGHWAY COMPONENT TRANSLATION LIST

CODE	DESCRIPTION
0	MAINLINE STATE HIGHWAY
1	COUPLET
3	FRONTAGE ROAD
6	CONNECTION
8	HIGHWAY - OTHER

INJURY SEVERITY CODE TRANSLATION LIST

CODE	SHORT DESC	LONG DESCRIPTION
1	KILL	FATAL INJURY
2	INJA	INCAPACITATING INJURY - BLEEDING, BROKEN BONES
3	INJB	NON-INCAPACITATING INJURY
4	INJC	POSSIBLE INJURY - COMPLAINT OF PAIN
5	PRI	DIED PRIOR TO CRASH
7	NO<5	NO INJURY - 0 TO 4 YEARS OF AGE

LIGHT CONDITION CODE TRANSLATION LIST

CODE	SHORT DESC	LONG DESCRIPTION
0	UNK	UNKNOWN
1	DAY	DAYLIGHT
2	DLIT	DARKNESS - WITH STREET LIGHTS
3	DARK	DARKNESS - NO STREET LIGHTS
4	DAWN	DAWN (TWILIGHT)
5	DUSK	DUSK (TWILIGHT)

MEDIAN TYPE CODE TRANSLATION LIST

CODE	SHORT DESC	LONG DESCRIPTION
0	NONE	NO MEDIAN
1	RSDMD	SOLID MEDIAN BARRIER
2	DIVMD	EARTH, GRASS OR PAVED MEDIAN

MILEAGE TYPE CODE TRANSLATION LIST

CODE	LONG DESCRIPTION
0	REGULAR MILEAGE
T	TEMPORARY
Y	SPUR
Z	OVERLAPPING

MOVEMENT TYPE CODE TRANSLATION LIST

CODE	SHORT DESC	LONG DESCRIPTION
0	UNK	UNKNOWN
1	STRGHT	STRAIGHT AHEAD
2	TURN-R	TURNING RIGHT
3	TURN-L	TURNING LEFT
4	U-TURN	MAKING A U-TURN
5	BACK	BACKING
6	STOP	STOPPED IN TRAFFIC
7	PRKD-P	PARKED - PROPERLY
8	PRKD-I	PARKED - IMPROPERLY

PARTICIPANT TYPE CODE TRANSLATION LIST

CODE	SHORT DESC	LONG DESCRIPTION
0	OCC	UNKNOWN OCCUPANT TYPE
1	DRVR	DRIVER
2	PSNG	PASSENGER
3	PED	PEDESTRIAN
4	CONV	PEDESTRIAN USING A PEDESTRIAN CONVEYANCE
5	PTOW	PEDESTRIAN TOWING OR TRAILERING AN OBJECT
6	BIKE	PEDALCYCLIST
7	BTOW	PEDALCYCLIST TOWING OR TRAILERING AN OBJECT
8	PRKD	OCCUPANT OF A PARKED MOTOR VEHICLE
9	UNK	UNKNOWN TYPE OF NON-MOTORIST

PEDESTRIAN LOCATION CODE TRANSLATION LIST

CODE	LONG DESCRIPTION
00	AT INTERSECTION - NOT IN ROADWAY
01	AT INTERSECTION - INSIDE CROSSWALK
02	AT INTERSECTION - IN ROADWAY, OUTSIDE CROSSWALK
03	AT INTERSECTION - IN ROADWAY, XWALK AVAIL UNKNWN
04	NOT AT INTERSECTION - IN ROADWAY
05	NOT AT INTERSECTION - ON SHOULDER
06	NOT AT INTERSECTION - ON MEDIAN
07	NOT AT INTERSECTION - WITHIN TRAFFIC RIGHT-OF-WAY
08	NOT AT INTERSECTION - IN BIKE PATH OR PARKING LANE
09	NOT-AT INTERSECTION - ON SIDEWALK
10	OUTSIDE TRAFFICWAY BOUNDARIES
13	AT INTERSECTION - IN BIKE LANE
14	NOT AT INTERSECTION - IN BIKE LANE
15	NOT AT INTERSECTION - INSIDE MID-BLOCK CROSSWALK
16	NOT AT INTERSECTION - IN PARKING LANE

TRAFFIC CONTROL DEVICE CODE TRANSLATION LIST

CODE	SHORT DESC	LONG DESCRIPTION
000	NONE	NO CONTROL
001	TRF SIGNAL	TRAFFIC SIGNALS
002	FLASHBCN-R	FLASHING BEACON - RED (STOP)
003	FLASHBCN-A	FLASHING BEACON - AMBER (SLOW)
004	STOP SIGN	STOP SIGN
005	SLOW SIGN	SLOW SIGN
006	REG-SIGN	REGULATORY SIGN
007	YIELD	YIELD SIGN
008	WARNING	WARNING SIGN
009	CURVE	CURVE SIGN
010	SCHL X-ING	SCHOOL CROSSING SIGN OR SPECIAL SIGNAL
011	OFCR/FLAG	POLICE OFFICER, FLAGMAN - SCHOOL PATROL
012	BRDG-GATE	BRIDGE GATE - BARRIER
013	TEMP-BARR	TEMPORARY BARRIER
014	NO-PASS-ZN	NO PASSING ZONE
015	ONE-WAY	ONE-WAY STREET
016	CHANNEL	CHANNELIZATION
017	MEDIAN BAR	MEDIAN BARRIER
018	PILOT CAR	PILOT CAR
019	SP PED SIG	SPECIAL PEDESTRIAN SIGNAL
020	X-BUCK	CROSSBUCK
021	THR-GN-SIG	THROUGH GREEN ARROW OR SIGNAL
022	L-GRN-SIG	LEFT TURN GREEN ARROW, LANE MARKINGS, OR SIGNAL
023	R-GRN-SIG	RIGHT TURN GREEN ARROW, LANE MARKINGS, OR SIGNAL
024	WIGWAG	WIGWAG OR FLASHING LIGHTS W/O DROP-ARM GATE
025	X-BUCK WRN	CROSSBUCK AND ADVANCE WARNING
026	WW W/ GATE	FLASHING LIGHTS WITH DROP-ARM GATES
027	OVRHD SGNL	SUPPLEMENTAL OVERHEAD SIGNAL (RR XING ONLY)
028	SP RR STOP	SPECIAL RR STOP SIGN
029	ILLUM GRD X	ILLUMINATED GRADE CROSSING
037	RAMP METER	METERED RAMPS
038	RUMBLE STR	RUMBLE STRIP
090	L-TURN REF	LEFT TURN REFUGE (WHEN REFUGE IS INVOLVED)
091	R-TURN ALL	RIGHT TURN AT ALL TIMES SIGN, ETC.
092	EMR SGN/FL	EMERGENCY SIGNS OR FLARES
093	ACCEL LANE	ACCELERATION OR DECELERATION LANES
094	R-TURN PRO	RIGHT TURN PROHIBITED ON RED AFTER STOPPING

ROAD CHARACTER CODE TRANSLATION LIST

CODE	SHORT DESC	LONG DESCRIPTION
0	UNK	UNKNOWN
1	INTER	INTERSECTION
2	ALLEY	DRIVEWAY OR ALLEY
3	STRGHT	STRAIGHT ROADWAY
4	TRANS	TRANSITION
5	CURVE	CURVE (HORIZONTAL CURVE)
6	OPENAC	OPEN ACCESS OR TURNOUT
7	GRADE	GRADE (VERTICAL CURVE)
8	BRIDGE	BRIDGE STRUCTURE
9	TUNNEL	TUNNEL

095 BUS STPSGN BUS STOP SIGN AND RED LIGHTS
099 UNKNOWN UNKNOWN OR NOT DEFINITE

VEHICLE TYPE CODE TRANSLATION LIST

CODE	SHORT DESC	LONG DESCRIPTION
00	PDO	NOT COLLECTED FOR PDO CRASHES
01	PSNGR CAR	PASSENGER CAR, PICKUP, LIGHT DELIVERY, ETC.
02	BOBTAIL	TRUCK TRACTOR WITH NO TRAILERS (BOBTAIL)
03	FARM TRCTR	FARM TRACTOR OR SELF-PROPELLED FARM EQUIPMENT
04	SEMI TOW	TRUCK TRACTOR WITH TRAILER/MOBILE HOME IN TOW
05	TRUCK	TRUCK WITH NON-DETACHABLE BED, PANEL, ETC.
06	MOPED	MOPED, MINIBIKE, SEATED MOTOR SCOOTER, MOTOR BIKE
07	SCHL BUS	SCHOOL BUS (INCLUDES VAN)
08	OTH BUS	OTHER BUS
09	MTRCYCLE	MOTORCYCLE, DIRT BIKE
10	OTHER	OTHER: FORKLIFT, BACKHOE, ETC.
11	MOTRHOME	MOTORHOME
12	TROLLEY	MOTORIZED STREET CAR/TROLLEY (NO RAILS/WIRES)
13	ATV	ATV
14	MTRSCTR	MOTORIZED SCOOTER (STANDING)
15	SNOWMOBILE	SNOWMOBILE
99	UNKNOWN	UNKNOWN VEHICLE TYPE

WEATHER CONDITION CODE TRANSLATION LIST

CODE	SHORT DESC	LONG DESCRIPTION
0	UNK	UNKNOWN
1	CLR	CLEAR
2	CLD	CLOUDY
3	RAIN	RAIN
4	SLT	SLEET
5	FOG	FOG
6	SNOW	SNOW
7	DUST	DUST
8	SMOK	SMOKE
9	ASH	ASH

December 13, 2017

Project #: 21156

Tony Doran
City of Tualatin
18880 SW Martinazzi Avenue
Tualatin, OR 97062

RE: Tualatin High School Expansion - Response to Transportation Incompleteness Comments

Dear Tony,

This letter responds to the transportation-related incompleteness comments identified in the City of Tualatin's November 15, 2017 letter for the Tualatin High School Expansion project. The specific comments are reproduced below in italics, followed by our response.

2. Transportation.

a. Please provide queues. The City receives complaints that traffic regularly backs up between SW Ibach Street and the access to the high school. Include identification of queues, evaluation with any mitigation, and include this in narrative responses to code.

Response: As part of the transportation assessment, we have observed vehicle queues during the weekday AM, afternoon PM, and evening PM peak time periods. During all three time periods, northbound vehicle queues were observed to extend from the signalized SW Ibach Street intersection to and beyond the northerly Tualatin High School driveway. While these vehicle queues can be long during peak time periods, they are a function of heavy vehicular demand on SW Boones Ferry Road and the short-duration peaking characteristics of Tualatin High School traffic. Although the maximum vehicle queues at times extend beyond the northerly high school driveway, it was observed that most SW Boones Ferry Road drivers leave courtesy gaps at the driveway to allow continued ingress and egress movements.

As noted in the October 24, 2017 *Tualatin High School Expansion – Transportation Assessment* report, the Tigard-Tualatin School District is not intending nor anticipating that the expansion will accommodate increased student enrollment or faculty increase. No measurable increase in student, staff, or bus trips are anticipated beyond existing conditions, therefore the proposed expansion is not anticipated to alter or worsen existing queueing conditions along SW Boones Ferry Road. Given there is no anticipated site development impact to the existing queueing situation associated with the school expansion, we find no nexus to require mitigation of the current queueing in conjunction with the school project.

b. Washington County Safety Priority Index System doesn't include roads that aren't under county jurisdiction, so the roads in the study would not be eligible to be on the list.

Response: Noted.

3. Pedestrian and Bicycle.

a. Because a high school typically generates pedestrian and bicycle traffic, include evaluation and any mitigation. Propose improvements to address onsite circulation and assess multi-modal traffic interactions such as routes for pedestrians to not cross the north access at SW Boones Ferry Road at the right-of-way but further back onsite.

Response: As noted in the October 24, 2017 *Tualatin High School Expansion – Transportation Assessment* report, sidewalks and bicycle lanes are provided along SW Boones Ferry Road and SW Ibach Street providing both local and regional bicycle/pedestrian access to the school campus. In addition to this infrastructure, the campus connects to the adjacent residential neighborhoods via a multi-use pathway. This pathway network and the accompanying on-site pedestrian circulation system (illustrated in the attached exhibit) provides connections to SW Iowa Drive to the south, SW Palouse Drive to the south, SW Martinazzi Avenue to the east, and Byrom Elementary School/SW Osage Street to the north. As such, many students who walk to school already have a fairly comprehensive and connected pathway network that minimizes the need to walk along the busier SW Boones Ferry Road corridor. As shown in the exhibit, the proposed expansion will not impact the on-site circulation system.

With regards to the topic of pedestrians crossing the north school driveway off of SW Boones Ferry Road, all of the pedestrian infrastructure leading to the school entrance is located on the south side of the school driveway and connecting access road because it provides the most direct and convenient route. If pedestrian improvements were made to the north side of the driveway, they would funnel pedestrians directly into the parking area or require a significantly longer route around the parking lot that most students would likely find too inconvenient.

It should be noted that the pedestrian ramps at both school access driveways to SW Boones Ferry Road will be reconstructed to meet current ADA standards. In addition, lighting improvements (see below for a separate response to lighting issues) will be made at both school driveways to enhance the visibility of pedestrians and vehicles.

b. Because pedestrians use both sides of SW Boones Ferry Road, address the sidewalk gap on the west side.

Response: There currently is a 425 foot gap in the sidewalk network along the west of SW Boones Ferry Road. This gap is adjacent to several older properties that have not redeveloped and therefore have not provided sidewalk frontage improvements. This gap is not located along the Tualatin High School frontage. Field observations at the gap site revealed that most pedestrians do not walk along this

segment of SW Boones Ferry Road and instead cross over to the east side of the road at the SW Ibach Street intersection to the north or the formal mid-block pedestrian crossing to the south.

While extension of the sidewalk to remove the gap is desirable from a pedestrian system perspective, we find no nexus to require mitigation of the current queuing in conjunction with the school project given that no measurable increase in student, staff, or bus trips are anticipated beyond existing conditions.

4. Evaluate street lights to verify that the existing illumination may be inadequate per Public Works Construction Code. This is especially important at the accesses to SW Boones Ferry Road. Evaluate and provide narrative to indicate if the current illumination meets code or if additional street lights are needed.

Response: A separate letter (attached) has been prepared to address the existing light levels at the two school driveways off of SW Boones Ferry Road. Based on the results of this assessment, the Tigard-Tualatin School District intends to work with the City of Tualatin to prepare a lighting mitigation plan that would enhance light levels and the overall visibility of the driveways at SW Boones Ferry Road.

We trust this letter adequately addresses your questions and issues and welcome additional dialogue as appropriate. Please contact us if you would like to further discuss.

Sincerely,
KITTELSON & ASSOCIATES, INC.



Matt Hugart, AICP
Associate Planner



Chris Brehmer, P.E.
Senior Principal Engineer



December 8, 2017

Project #: 21156

Tony Doran
City of Tualatin
18880 SW Martinazzi Avenue
Tualatin, OR 97062

RE: Tualatin High School SW Boones Ferry Road Access Driveway Lighting

Dear Tony,

This letter summarizes the methodology and results of an existing photometric analysis of Tualatin High School's two access driveways located off of SW Boones Ferry Road.

Overview

Kittelison & Associates, Inc. (KAI) began the existing photometric analysis with an inventory of existing street lighting on SW Boones Ferry Road between SW Ibach Street and the southerly extents of the Tualatin High School frontage. Luminaire locations and types, including mounting heights and mast arms lengths, were field-verified and confirmed by PGE staff.

The existing conditions photometric analysis was then performed using the AGi32 lighting analysis software package to digitally represent the intensity and distribution of light projected from luminaires along SW Boones Ferry Road to evaluate the photometric performance on the roadway at the school access driveways.

Calculation Zones

The existing conditions photometric analysis at the SW Boones Ferry Road school driveways was performed at the intersection level based on guidance in Illumination Engineering Society Recommended Practice RP-8-14. In particular, the driveway intersections were determined to be the area where the driveway meets SW Boones Ferry Road bounded by the far side of the crosswalks or the ends of the curb returns.

Existing Lighting Conditions

Table summarizes the existing conditions photometric analysis. As shown in the table, both school access driveways do not meeting current design standards.

Table 1 – Lighting Analysis Results

Intersection	Parameter	Design Standard	Existing Conditions
SW Boones Ferry Road / North Tualatin High School Driveway	Illuminance	≥ 0.9 fc	0.36 fc
	Avg./Min Ratio	$\leq 3:1$	3.6 : 1
SW Boones Ferry Road / South Tualatin High School Driveway	Illuminance	≥ 0.9 fc	0.32 fc
	Avg./Min Ratio	$\leq 3:1$	3.2 : 1

Sincerely,
KITTELSON & ASSOCIATES, INC.



Matt Hughart, AICP
Associate Planner



Wade Scarbrough, P.E.
Associate Engineer

Tree Inventory & Assessment

Tualatin High School
Tualatin, OR

Prepared for:
Tigard Tualatin School District
6960 SW Sandburg Street
Tigard, OR 97223

Prepared by:
Oregon Tree Care
PO Box 13068
Portland, OR 97213

October 16, 2017



RE Tree assessment and inventory for trees located on the school district grounds identified as Tualatin High School in Tualatin, Oregon.

Date October 16, 2017

Attention Juliet Jacobsen, Project Coordinator, Day CPM, jjacobsen@daycpm.com

Site Address Tualatin High School
22300 SW Boones Ferry Road, Tualatin, Oregon 97062

Contents

Assignment & Scope of Report

Limits of Assignment

Methods

Observations & Statements

- General Information
- Identified Trees with Root Concerns
- Identified Trees within 10' of a Structure

Appendix A – Site Plans & Inventory

- Site Plan provided by Day CPM
- Inventory Site Plan
- Tree Inventory

Appendix B – Project Documentation

Appendix C – Assumptions & Limiting Conditions

Appendix D – Bibliography & Glossary

Assignment & Scope of Work

We were contacted on June 28, 2017 by Juliet Jacobsen, on behalf of the Tigard Tualatin School District, to offer our Certified Arborist consulting/reporting services. Oregon Tree Care (OTC) then conducted a site visit to the property on September 13, 2017. A visual assessment of 275 trees total was conducted that included identification, dbh measurement, inventory mapping, inspection of roots for any existing concerns to surrounding hardscape and structures. On September 18, 2017, we were contacted regarding additional information to be included in the Report. On September 29, 2017, we were asked to tag all inventoried trees which was completed during a subsequent site visit on October 5th. The data collected is summarized in this Report.

The additional note included in the RFP addressing “quantities, location and character of trees that may require removal due to new construction where that removal will initiate mandatory mitigation” will require a site plan showing planned construction activities in relation to the existing trees – to include the distance from the tree to the edge of any new structures, changes in landscape, excavation, trenching etc. If the ground will be disturbed, measurements to help determine potential encroachment to the CRZ is required. Measurement should be made from the base of the tree to the closest point of ground disturbance or structure.

Limits of Assignment

Unless stated otherwise: 1) Information contained in this report covers only those trees that were examined and reflects the condition of those trees at the time of inspection; and 2) The inspection is limited to visual examination of the subject trees without dissection, probing, or coring unless explicitly specified. There is no warranty or guarantee, expressed or implied, that problems or deficiencies of the subject trees may not arise in the future. Additional Assumptions and Limiting Conditions can be found in Appendix C.

Methods

We used a Visual Tree Assessment (VTA) method to evaluate tree health, structure and root system at ground level. VTA is based on the outward indications of tree stress and growth, as indicated by the formation of new tree parts, the shape of the new wood and the amount of live tissue. Trees adapt to current and past stress by growing wood to support themselves in an upright condition. This type of assessment is facilitated by our personal knowledge of tree growth as it relates to structural integrity. We used a diameter tape marked in inches on one side and with diameter calculations on the opposite for measuring tree diameter.

Observations & Statements

Based on the described scope of work and after the initial site visit to walk through the property, an inventory was completed to include mapping to match identification numbers for the 187 trees during the initial site visit. All trees, at the time of the site visit, were deemed to have average vigor with the exception of the following trees which were deemed to have poor vigor:

- Tree #96 Cherry (*Prunus serrulata*) 4” dbh
- Tree #97 Cherry (*Prunus serrulata*) 5” dbh
- Tree #98 Cherry (*Prunus serrulata*) 4” dbh
- Tree #111 Cherry (*Prunus serrulata*) 4” dbh
- Tree #164 Cherry (*Prunus serrulata*) 5” dbh
- Tree #165 Cherry (*Prunus serrulata*) 5” dbh

ROOT INSPECTION: Trees included in inventory were inspected for signs of root systems “that have roots that project above the surrounding finish grade and whether or not that projection has caused structural defect in any constructed elements such as buildings, roads, retaining walls, curbs or sidewalk.” At the time of the site visit, we identified the following trees showing signs of root concern as qualified above in having “caused structural defect”; those trees are identified as follows:

- Tree #114, Cherry. The sidewalk in the area showing signs of lifting which could be caused by the tree roots
- Tree #146, Cherry. The sidewalk in the area showing signs of lifting which could be caused by the tree roots.
- Tree #159, Cherry. The sidewalk in the area showing signs of lifting which could be caused by the tree roots.
- Tree #160, Cherry. The sidewalk in the area showing signs of lifting which could be caused by the tree roots.
- Tree #161, Cherry. The sidewalk in the area showing signs of lifting which could be caused by the tree roots.

OREGON TREE CARE . TREES LOCATED WITHIN 10' OF A STRUCTURE



LOCATION: Tualatin High School

SITE VISIT CERTIFIED
DATE: 13-Sep-17 ARBORIST:

Damien Carre . PN-6405A

TREES LOCATED WITHIN 10' OF STRUCTURE: Several trees were identified as being within 10' of a structure:

Map ID Number	Tree Type	Distance from Structure	Map ID Number	Tree Type	Distance from Structure	Map ID Number	Tree Type	Distance from Structure	Map ID Number	Tree Type	Distance from Structure
1	Cherry	8	31	Cherry	8	109	Cherry	5	158	Cherry	2
2	Cherry	3	32	Cherry	9	110	Cherry	5	159	Cherry	2
3	Cherry	4	33	Cherry	8	111	Cherry	5	160	Cherry	2
4	Cherry	3	35	Cherry	8	113	Cherry	8	161	Cherry	2
5	Cherry	4	36	Cherry	9	114	Cherry	8	163	Cherry	8
6	Cherry	8	37	Cherry	9	115	Cherry	8	164	Cherry	8
7	Red Maple	7	74	Red Maple	9	116	Cherry	8	165	Cherry	8
8	Red Maple	7	78	Red Maple	5	117	Cherry	8	166	Cherry	8
9	Red Maple	8	79	Red Maple	5	118	Cherry	8	167	Cherry	8
10	Red Maple	7	80	Red Maple	5	119	Cherry	8	168	Cherry	8
11	Red Maple	7	81	Red Maple	5	120	Cherry	8	169	Cherry	9
12	Red Maple	5	82	Red Maple	5	121	Incense Cedar	8	173	Cherry	9
13	Red Maple	7	87	Cherry	5	124	Incense Cedar	8	174	Cherry	9
14	Red Maple	6	88	Cherry	5	125	Oregon Ash	8	175	Cherry	9
15	Red Maple	7	89	Cherry	4	126	Oregon Ash	1	176	Cherry	9
16	Red Maple	7	90	Cherry	5	131	Oregon Ash	8	177	Cherry	9
17	Red Maple	7	91	Cherry	5	132	Oregon Ash	4	178	Cherry	9
18	Red Maple	7	92	Cherry	6	133	Oregon Ash	8	179	Cherry	9
19	Red Maple	7	93	Cherry	8	134	Oregon Ash	8	185	Boulevard Cypress	2
20	Red Maple	8	96	Cherry	2	142	Cherry	6	186	Boulevard Cypress	2
21	Red Maple	7	97	Cherry	2	143	Cherry	6	187	Boulevard Cypress	2
22	Red Maple	7	99	Cherry	3	144	Cherry	6			
23	Red Maple	6	100	Cherry	2	145	Cherry	6			
24	Red Maple	7	101	Cherry	3	146	Cherry	6			
25	Red Maple	7	102	Cherry	2	147	Cherry	6			
27	Cherry	7	103	Cherry	3	152	Cherry	8			
28	Cherry	7	104	Cherry	4	153	Cherry	8			
29	Cherry	6	105	Cherry	4	156	Cherry	2			
30	Cherry	8	108	Cherry	5	157	Cherry	2			

OREGON TREE CARE . TREE INVENTORY



LOCATION: Tualatin High School
SITE VISIT DATE: 13-Sep-17
CERTIFIED ARBORIST: Damien Cairre . PN-6405A

Condition rating key: 0- dead to severe decline / 1- declining / 2- average / 3- good to excellent
 Preserve rating key: 0- hazard tree / 1- dead to severe decline/ 2- average health/ 3- good to excellent health

Map ID Number	Tree Type	Tree Species	DBH	Canopy (ft ²)	Condition Rating	Preserve Rating	Heritage Tree?	Open or Stand Grown?	Preserve or Remove?
1	Cherry	<i>Prunus serrulata</i>	12	491	3	3	N	Open	Preserve
2	Cherry	<i>Prunus serrulata</i>	16	707	3	3	N	Open	Preserve
3	Cherry	<i>Prunus serrulata</i>	13	754	3	3	N	Open	Preserve
4	Cherry	<i>Prunus serrulata</i>	13	754	3	3	N	Open	Preserve
5	Cherry	<i>Prunus serrulata</i>	11	907	3	3	N	Open	Preserve
6	Cherry	<i>Prunus serrulata</i>	14	452	3	3	N	Open	Preserve
7	Red Maple	<i>Acer rubrum</i>	11	346	3	3	N	Open	Preserve
8	Red Maple	<i>Acer rubrum</i>	8	177	3	3	N	Open	Preserve
9	Red Maple	<i>Acer rubrum</i>	10	491	3	3	N	Open	Preserve
10	Red Maple	<i>Acer rubrum</i>	9	254	3	3	N	Open	Preserve
11	Red Maple	<i>Acer rubrum</i>	9	177	3	3	N	Open	Preserve
12	Red Maple	<i>Acer rubrum</i>	11	227	3	3	N	Open	Preserve
13	Red Maple	<i>Acer rubrum</i>	8	177	3	3	N	Open	Preserve
14	Red Maple	<i>Acer rubrum</i>	8	177	3	3	N	Open	Preserve
15	Red Maple	<i>Acer rubrum</i>	11	707	3	3	N	Open	Preserve
16	Red Maple	<i>Acer rubrum</i>	8	133	3	3	N	Open	Preserve
17	Red Maple	<i>Acer rubrum</i>	7	133	3	3	N	Open	Preserve
18	Red Maple	<i>Acer rubrum</i>	11	154	3	3	N	Open	Preserve
19	Red Maple	<i>Acer rubrum</i>	8	177	3	3	N	Open	Preserve
20	Red Maple	<i>Acer rubrum</i>	9	154	3	3	N	Open	Preserve
21	Red Maple	<i>Acer rubrum</i>	8	133	3	3	N	Open	Preserve
22	Red Maple	<i>Acer rubrum</i>	7	133	3	3	N	Open	Preserve

OREGON TREE CARE . TREE INVENTORY



LOCATION: Tualatin High School
 SITE VISIT DATE: 13-Sep-17
 CERTIFIED ARBORIST: Damien Cairre . PN-6405A

Condition rating key: 0- dead to severe decline / 1- declining / 2- average / 3- good to excellent
 Preserve rating key: 0- hazard tree / 1- dead to severe decline/ 2- average health/ 3- good to excellent health

Map ID Number	Tree Type	Tree Species	DBH	Canopy (ft ²)	Condition Rating	Preserve Rating	Heritage Tree?	Open or Stand Grown?	Preserve or Remove?
23	Red Maple	<i>Acer rubrum</i>	9	201	3	3	N	Open	Preserve
24	Red Maple	<i>Acer rubrum</i>	8	133	3	3	N	Open	Preserve
25	Red Maple	<i>Acer rubrum</i>	8	95	3	3	N	Open	Preserve
26	Cherry	<i>Prunus serrulata</i>	15	754	3	3	N	Open	Preserve
27	Cherry	<i>Prunus serrulata</i>	16	707	3	3	N	Open	Preserve
28	Cherry	<i>Prunus serrulata</i>	15	660	3	3	N	Open	Preserve
29	Cherry	<i>Prunus serrulata</i>	12	572	3	3	N	Open	Preserve
30	Cherry	<i>Prunus serrulata</i>	11	415	3	3	N	Open	Preserve
31	Cherry	<i>Prunus serrulata</i>	10	452	3	3	N	Open	Preserve
32	Cherry	<i>Prunus serrulata</i>	9	452	3	3	N	Open	Preserve
33	Cherry	<i>Prunus serrulata</i>	13	754	3	3	N	Open	Preserve
34	Cherry	<i>Prunus serrulata</i>	12	707	3	3	N	Open	Preserve
35	Cherry	<i>Prunus serrulata</i>	14	707	3	3	N	Open	Preserve
36	Cherry	<i>Prunus serrulata</i>	14	855	3	3	N	Open	Preserve
37	Cherry	<i>Prunus serrulata</i>	12	804	3	3	N	Open	Preserve
38	Cherry	<i>Prunus serrulata</i>	17	962	3	3	N	Open	Preserve
39	Cherry	<i>Prunus serrulata</i>	10	452	3	3	N	Open	Preserve
40	Cherry	<i>Prunus serrulata</i>	12	707	3	3	N	Open	Preserve
41	Cherry	<i>Prunus serrulata</i>	13	754	3	3	N	Open	Preserve
42	Cherry	<i>Prunus serrulata</i>	14	415	3	3	N	Open	Preserve
43	Cherry	<i>Prunus serrulata</i>	13	804	3	3	N	Open	Preserve

OREGON TREE CARE . TREE INVENTORY



LOCATION: Tualatin High School
 SITE VISIT DATE: 13-Sep-17
 CERTIFIED ARBORIST: Damien Cairre . PN-6405A

Condition rating key: 0- dead to severe decline / 1- declining / 2- average / 3- good to excellent
 Preserve rating key: 0- hazard tree / 1- dead to severe decline/ 2- average health/ 3- good to excellent health

Map ID Number	Tree Type	Tree Species	DBH	Canopy (ft ²)	Condition Rating	Preserve Rating	Heritage Tree?	Open or Stand Grown?	Preserve or Remove?
44	Cherry	<i>Prunus serrulata</i>	15	1017	3	3	N	Open	Preserve
45	Cherry	<i>Prunus serrulata</i>	20	754	3	3	N	Open	Preserve
46	Incense Cedar	<i>Calocedrus decurrens</i>	21	346	3	3	N	Open	Preserve
47	Incense Cedar	<i>Calocedrus decurrens</i>	21	201	3	3	N	Open	Preserve
48	Incense Cedar	<i>Calocedrus decurrens</i>	11	38	3	3	N	Open	Preserve
49	Ash	<i>Fraxinus</i>	10	754	3	3	N	Open	Preserve
50	Ash	<i>Fraxinus</i>	11	962	3	3	N	Open	Preserve
51	Ash	<i>Fraxinus</i>	12	804	3	3	N	Open	Preserve
52	Ash	<i>Fraxinus</i>	11	754	3	3	N	Open	Preserve
53	Red Maple	<i>Acer rubrum</i>	9	314	3	3	N	Open	Preserve
54	Ash	<i>Fraxinus</i>	11	707	3	3	N	Open	Preserve
55	Ash	<i>Fraxinus</i>	11	1194	3	3	N	Open	Preserve
56	Ash	<i>Fraxinus</i>	10	707	3	3	N	Open	Preserve
57	Silver Maple	<i>Acer saccharinum</i>	15	1194	3	3	N	Open	Preserve
58	Ash	<i>Fraxinus</i>	10	907	3	3	N	Open	Preserve
59	Ash	<i>Fraxinus</i>	9	804	3	3	N	Stand	Preserve
60	Ash	<i>Fraxinus</i>	11	707	3	3	N	Stand	Preserve
61	Incense Cedar	<i>Calocedrus decurrens</i>	15	133	3	3	N	Stand	Preserve
62	Incense Cedar	<i>Calocedrus decurrens</i>	18	227	3	3	N	Stand	Preserve
63	Incense Cedar	<i>Calocedrus decurrens</i>	11	133	3	3	N	Stand	Preserve

OREGON TREE CARE . TREE INVENTORY



LOCATION: Tualatin High School
 SITE VISIT DATE: 13-Sep-17
 CERTIFIED ARBORIST: Damien Cairre . PN-6405A

Condition rating key: 0- dead to severe decline / 1- declining / 2- average / 3- good to excellent
 Preserve rating key: 0- hazard tree / 1- dead to severe decline/ 2- average health/ 3- good to excellent health

Map ID Number	Tree Type	Tree Species	DBH	Canopy (ft.)	Condition Rating	Preserve Rating	Heritage Tree?	Open or Stand Grown?	Preserve or Remove?
64	Incense Cedar	<i>Calocedrus decurrens</i>	20	415	3	3	N	Stand	Preserve
65	Cherry	<i>Prunus serrulata</i>	14	660	3	3	N	Stand	Preserve
66	Cherry	<i>Prunus serrulata</i>	12	380	3	3	N	Stand	Preserve
67	Cherry	<i>Prunus serrulata</i>	14	452	3	3	N	Stand	Preserve
68	Cherry	<i>Prunus serrulata</i>	13	491	3	3	N	Stand	Preserve
69	Cherry	<i>Prunus serrulata</i>	11	572	3	3	N	Stand	Preserve
70	Cherry	<i>Prunus serrulata</i>	11	962	3	3	N	Stand	Preserve
71	Incense Cedar	<i>Calocedrus decurrens</i>	17	346	3	3	N	Stand	Preserve
72	Incense Cedar	<i>Calocedrus decurrens</i>	13	113	3	3	N	Stand	Preserve
73	Incense Cedar	<i>Calocedrus decurrens</i>	20	254	3	3	N	Stand	Preserve
74	Red Maple	<i>Acer rubrum</i>	9	133	3	3	N	Open	Preserve
75	Red Maple	<i>Acer rubrum</i>	6	154	3	3	N	Open	Preserve
76	Red Maple	<i>Acer rubrum</i>	6	133	3	3	N	Open	Preserve
77	Red Maple	<i>Acer rubrum</i>	5	133	3	3	N	Open	Preserve
78	Red Maple	<i>Acer rubrum</i>	11	415	3	3	N	Open	Preserve
79	Red Maple	<i>Acer rubrum</i>	12	380	3	3	N	Open	Preserve
80	Red Maple	<i>Acer rubrum</i>	8	380	3	3	N	Open	Preserve
81	Red Maple	<i>Acer rubrum</i>	8	415	3	3	N	Open	Preserve
82	Red Maple	<i>Acer rubrum</i>	13	754	3	3	N	Open	Preserve
83	Incense Cedar	<i>Calocedrus decurrens</i>	19	227	3	3	N	Open	Preserve

OREGON TREE CARE . TREE INVENTORY



LOCATION: Tualatin High School
 SITE VISIT DATE: 13-Sep-17
 CERTIFIED ARBORIST: Damien Cairre . PN-6405A

Condition rating key: 0- dead to severe decline / 1- declining / 2- average / 3- good to excellent
 Preserve rating key: 0- hazard tree / 1- dead to severe decline/ 2- average health/ 3- good to excellent health

Map ID Number	Tree Type	Tree Species	DBH	Canopy (ft.)	Condition Rating	Preserve Rating	Heritage Tree?	Open or Stand Grown?	Preserve or Remove?
84	Incense Cedar	<i>Calocedrus decurrens</i>	36	491	3	3	N	Open	Preserve
85	Ash	<i>Fraxinus</i>	14	1017	3	3	N	Open	Preserve
86	Ash	<i>Fraxinus</i>	14	804	3	3	N	Open	Preserve
87	Cherry	<i>Prunus serrulata</i>	13	804	3	3	N	Open	Preserve
88	Cherry	<i>Prunus serrulata</i>	13	707	3	3	N	Open	Preserve
89	Cherry	<i>Prunus serrulata</i>	14	907	3	3	N	Open	Preserve
90	Cherry	<i>Prunus serrulata</i>	14	855	3	3	N	Open	Preserve
91	Cherry	<i>Prunus serrulata</i>	13	855	3	3	N	Open	Preserve
92	Cherry	<i>Prunus serrulata</i>	15	804	3	3	N	Open	Preserve
93	Cherry	<i>Prunus serrulata</i>	10	754	3	3	N	Open	Preserve
94	Cherry	<i>Prunus serrulata</i>	11	452	3	3	N	Open	Preserve
95	Cherry	<i>Prunus serrulata</i>	8	201	3	3	N	Open	Preserve
96	Cherry	<i>Prunus serrulata</i>	4	38	1	1	N	Open	Remove
97	Cherry	<i>Prunus serrulata</i>	5	38	1	1	N	Open	Remove
98	Cherry	<i>Prunus serrulata</i>	4	50	1	1	N	Open	Remove
99	Cherry	<i>Prunus serrulata</i>	8	380	3	3	N	Open	Preserve
100	Cherry	<i>Prunus serrulata</i>	14	572	3	3	N	Open	Preserve
101	Cherry	<i>Prunus serrulata</i>	9	415	3	3	N	Open	Preserve
102	Cherry	<i>Prunus serrulata</i>	13	804	3	3	N	Open	Preserve
103	Cherry	<i>Prunus serrulata</i>	12	907	3	3	N	Open	Preserve

OREGON TREE CARE . TREE INVENTORY



LOCATION: Tualatin High School
 SITE VISIT DATE: 13-Sep-17
 CERTIFIED ARBORIST: Damien Cairre . PN-6405A

Condition rating key: 0- dead to severe decline / 1- declining / 2- average / 3- good to excellent
 Preserve rating key: 0- hazard tree / 1- dead to severe decline/ 2- average health/ 3- good to excellent health

Map ID Number	Tree Type	Tree Species	DBH	Canopy (ft.)	Condition Rating	Preserve Rating	Heritage Tree?	Open or Stand Grown?	Preserve or Remove?
104	Cherry	<i>Prunus serrulata</i>	16	962	3	3	N	Open	Preserve
105	Cherry	<i>Prunus serrulata</i>	10	907	3	3	N	Open	Preserve
106	Cherry	<i>Prunus serrulata</i>	11	1075	3	3	N	Open	Preserve
107	Cherry	<i>Prunus serrulata</i>	12	660	3	3	N	Open	Preserve
108	Cherry	<i>Prunus serrulata</i>	19	1075	3	3	N	Open	Preserve
109	Cherry	<i>Prunus serrulata</i>	10	415	3	3	N	Open	Preserve
110	Cherry	<i>Prunus serrulata</i>	15	707	3	3	N	Open	Preserve
111	Cherry	<i>Prunus serrulata</i>	4	79	1	1	N	Open	Remove
112	Cherry	<i>Prunus serrulata</i>	12	962	3	3	N	Open	Preserve
113	Cherry	<i>Prunus serrulata</i>	12	962	3	3	N	Open	Preserve
114	Cherry	<i>Prunus serrulata</i>	15	1590	3	3	N	Open	Preserve
115	Cherry	<i>Prunus serrulata</i>	15	1590	3	3	N	Open	Preserve
116	Cherry	<i>Prunus serrulata</i>	14	1590	3	3	N	Open	Preserve
117	Cherry	<i>Prunus serrulata</i>	14	1590	3	3	N	Open	Preserve
118	Cherry	<i>Prunus serrulata</i>	13	1590	3	3	N	Open	Preserve
119	Cherry	<i>Prunus serrulata</i>	13	1590	3	3	N	Open	Preserve
120	Cherry	<i>Prunus serrulata</i>	9	113	3	3	N	Open	Preserve
121	Incense Cedar	<i>Calocedrus decurrens</i>	23	133	3	3	N	Open	Preserve
122	Incense Cedar	<i>Calocedrus decurrens</i>	19	314	3	3	N	Open	Preserve
123	Incense Cedar	<i>Calocedrus decurrens</i>	31	415	3	3	N	Open	Preserve

OREGON TREE CARE . TREE INVENTORY



LOCATION: Tualatin High School
 SITE VISIT DATE: 13-Sep-17
 CERTIFIED ARBORIST: Damien Cairre . PN-6405A

Condition rating key: 0- dead to severe decline / 1- declining / 2- average / 3- good to excellent
 Preserve rating key: 0- hazard tree / 1- dead to severe decline/ 2- average health/ 3- good to excellent health

Map ID Number	Tree Type	Tree Species	DBH	Canopy (ft.)	Condition Rating	Preserve Rating	Heritage Tree?	Open or Stand Grown?	Preserve or Remove?
124	Incense Cedar	<i>Calocedrus decurrens</i>	13	314	3	3	N	Open	Preserve
125	Oregon Ash	<i>Fraxinus latifolia</i>	12	1256	3	3	N	Open	Preserve
126	Oregon Ash	<i>Fraxinus latifolia</i>	13	1256	3	3	N	Open	Preserve
127	Oregon Ash	<i>Fraxinus latifolia</i>	12	1256	3	3	N	Open	Preserve
128	Oregon Ash	<i>Fraxinus latifolia</i>	13	1256	3	3	N	Open	Preserve
129	Oregon Ash	<i>Fraxinus latifolia</i>	12	1256	3	3	N	Open	Preserve
130	Catalpa	<i>Catalpa bignonioides</i>	15	1590	3	3	N	Open	Preserve
131	Oregon Ash	<i>Fraxinus latifolia</i>	9	962	3	3	N	Open	Preserve
132	Oregon Ash	<i>Fraxinus latifolia</i>	11	962	3	3	N	Open	Preserve
133	Oregon Ash	<i>Fraxinus latifolia</i>	11	962	3	3	N	Open	Preserve
134	Oregon Ash	<i>Fraxinus latifolia</i>	11	962	3	3	N	Open	Preserve
135	Oregon Ash	<i>Fraxinus latifolia</i>	11	962	3	3	N	Open	Preserve
136	Oregon Ash	<i>Fraxinus latifolia</i>	9	707	3	3	N	Open	Preserve
137	Oregon Ash	<i>Fraxinus latifolia</i>	10	707	3	3	N	Open	Preserve
138	Oregon Ash	<i>Fraxinus latifolia</i>	8	314	3	3	N	Open	Preserve
139	Incense Cedar	<i>Calocedrus decurrens</i>	15	491	3	3	N	Open	Preserve
140	Incense Cedar	<i>Calocedrus decurrens</i>	24	491	3	3	N	Open	Preserve
141	Incense Cedar	<i>Calocedrus decurrens</i>	17	314	3	3	N	Open	Preserve
142	Cherry	<i>Prunus serrulata</i>	8	79	3	3	N	Open	Preserve
143	Cherry	<i>Prunus serrulata</i>	12	707	3	3	N	Open	Preserve

OREGON TREE CARE . TREE INVENTORY



LOCATION: Tualatin High School
 SITE VISIT DATE: 13-Sep-17
 CERTIFIED ARBORIST: Damien Cairre . PN-6405A

Condition rating key: 0- dead to severe decline / 1- declining / 2- average / 3- good to excellent
 Preserve rating key: 0- hazard tree / 1- dead to severe decline/ 2- average health/ 3- good to excellent health

Map ID Number	Tree Type	Tree Species	DBH	Canopy (ft.)	Condition Rating	Preserve Rating	Heritage Tree?	Open or Stand Grown?	Preserve or Remove?
144	Cherry	<i>Prunus serrulata</i>	12	707	3	3	N	Open	Preserve
145	Cherry	<i>Prunus serrulata</i>	9	707	3	3	N	Open	Preserve
146	Cherry	<i>Prunus serrulata</i>	10	707	3	3	N	Open	Preserve
147	Cherry	<i>Prunus serrulata</i>	8	707	3	3	N	Open	Preserve
148	Cherry	<i>Prunus serrulata</i>	9	707	3	3	N	Open	Preserve
149	Cherry	<i>Prunus serrulata</i>	9	177	3	3	N	Open	Preserve
150	Cherry	<i>Prunus serrulata</i>	6	177	3	3	N	Open	Preserve
151	Cherry	<i>Prunus serrulata</i>	11	177	3	3	N	Open	Preserve
152	Cherry	<i>Prunus serrulata</i>	10	177	3	3	N	Open	Preserve
153	Cherry	<i>Prunus serrulata</i>	6	177	3	3	N	Open	Preserve
154	Cherry	<i>Prunus serrulata</i>	15	177	3	3	N	Open	Preserve
155	Incense Cedar	<i>Calocedrus decurrens</i>	17	314	3	3	N	Open	Preserve
156	Cherry	<i>Prunus serrulata</i>	12	707	3	3	N	Open	Preserve
157	Cherry	<i>Prunus serrulata</i>	11	707	3	3	N	Open	Preserve
158	Cherry	<i>Prunus serrulata</i>	13	707	3	3	N	Open	Preserve
159	Cherry	<i>Prunus serrulata</i>	14	707	3	3	N	Open	Preserve
160	Cherry	<i>Prunus serrulata</i>	13	707	3	3	N	Open	Preserve
161	Cherry	<i>Prunus serrulata</i>	12	707	3	3	N	Open	Preserve
162	Cherry	<i>Prunus serrulata</i>	13	707	3	3	N	Open	Preserve
163	Cherry	<i>Prunus serrulata</i>	10	707	3	3	N	Open	Preserve

OREGON TREE CARE . TREE INVENTORY



LOCATION: Tualatin High School
 SITE VISIT DATE: 13-Sep-17
 CERTIFIED ARBORIST: Damien Cairre . PN-6405A

Condition rating key: 0- dead to severe decline / 1- declining / 2- average / 3- good to excellent
 Preserve rating key: 0- hazard tree / 1- dead to severe decline/ 2- average health/ 3- good to excellent health

Map ID Number	Tree Type	Tree Species	DBH	Canopy (ft.)	Condition Rating	Preserve Rating	Heritage Tree?	Open or Stand Grown?	Preserve or Remove?
164	Cherry	<i>Prunus serrulata</i>	5	177	1	1	N	Open	Remove
165	Cherry	<i>Prunus serrulata</i>	5	79	1	1	N	Open	Remove
166	Cherry	<i>Prunus serrulata</i>	9	113	3	3	N	Open	Preserve
167	Cherry	<i>Prunus serrulata</i>	10	177	3	3	N	Open	Preserve
168	Cherry	<i>Prunus serrulata</i>	10	177	3	3	N	Open	Preserve
169	Cherry	<i>Prunus serrulata</i>	3	113	3	3	N	Open	Preserve
170	Cherry	<i>Prunus serrulata</i>	5	113	3	3	N	Open	Preserve
171	Cherry	<i>Prunus serrulata</i>	13	707	3	3	N	Open	Preserve
172	Cherry	<i>Prunus serrulata</i>	9	113	3	3	N	Open	Preserve
173	Cherry	<i>Prunus serrulata</i>	12	491	3	3	N	Open	Preserve
174	Cherry	<i>Prunus serrulata</i>	9	491	3	3	N	Open	Preserve
175	Cherry	<i>Prunus serrulata</i>	10	491	3	3	N	Open	Preserve
176	Cherry	<i>Prunus serrulata</i>	6	314	3	3	N	Open	Preserve
177	Cherry	<i>Prunus serrulata</i>	12	491	3	3	N	Open	Preserve
178	Cherry	<i>Prunus serrulata</i>	8	314	3	3	N	Open	Preserve
179	Cherry	<i>Prunus serrulata</i>	8	177	3	3	N	Open	Preserve
180	Cherry	<i>Prunus serrulata</i>	11	314	3	3	N	Open	Preserve
181	Cherry	<i>Prunus serrulata</i>	14	707	3	3	N	Open	Preserve
182	Oregon Ash	<i>Fraxinus latifolia</i>	11	962	3	3	N	Open	Preserve
183	Oregon Ash	<i>Fraxinus latifolia</i>	12	962	3	3	N	Open	Preserve

OREGON TREE CARE . TREE INVENTORY



LOCATION: Tualatin High School
SITE VISIT DATE: 13-Sep-17
CERTIFIED ARBORIST: Damien Cairre . PN-6405A

Condition rating key: 0- dead to severe decline / 1- declining / 2- average / 3- good to excellent
 Preserve rating key: 0- hazard tree / 1- dead to severe decline/ 2- average health/ 3- good to excellent health

Map ID Number	Tree Type	Tree Species	DBH	Canopy (ft ₂)	Condition Rating	Preserve Rating	Heritage Tree?	Open or Stand Grown?	Preserve or Remove?
184	Oregon Ash	<i>Fraxinus latifolia</i>	10	707	3	3	N	Open	Preserve
185	Boulevard Cypress	<i>Chamaecyparis pisifera</i>	6	79	3	3	N	Open	Preserve
186	Boulevard Cypress	<i>Chamaecyparis pisifera</i>	7	79	3	3	N	Open	Preserve
187	Boulevard Cypress	<i>Chamaecyparis pisifera</i>	6	79	3	3	N	Open	Preserve

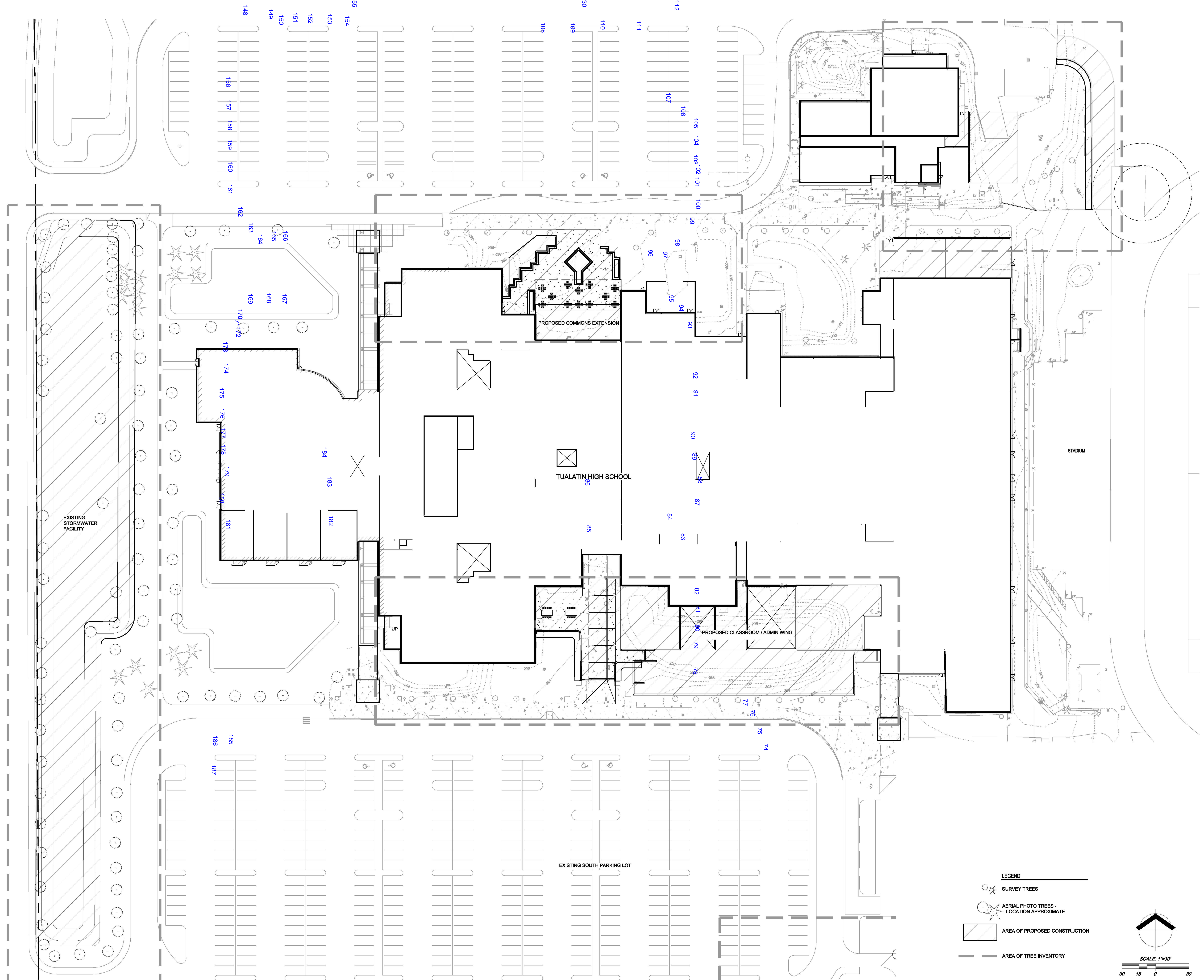

#	REVISIONS	DATE

TIGARD TUALATIN SD
TUALATIN HIGH SCHOOL

22300 SW BOONES FERRY RD.
TUALATIN, OR 97082

JOB NO: 21612290

ISSUE DATE:

Jurisdiction Stamp Area

TREE INVENTORY NORTH

AR1.00

LEGEND

- SURVEY TREES
- AERIAL PHOTO TREES - LOCATION APPROXIMATE
- AREA OF PROPOSED CONSTRUCTION
- AREA OF TREE INVENTORY

SCALE: 1"=30'

Appendix B - Project Documentation

28 June 2017

Tigard & Tualatin High School Survey - Request for Proposal

As a part of the remodel at Tigard High School (THS) and Tualatin High School (TuHS), TTSD desires to contract with a company to perform Arborist services for the above referenced projects under Direct Appointment Procedures as outlined in and in accordance with Public Contracting Rules. The purpose of this work will be to identify:

- which trees may need to be protected under City and other jurisdictional requirements;
- which trees may require additional attention due to their location, health, or other condition; and
- quantities, location and character of trees that may require removal due to new construction where that removal will initiate mandatory mitigation.

The work of the THS & TuHS project will be managed by Cathy Kraus with Day CPM, Project Manager for the District.

As an initial deliverable to the consultant the District and Bassetti (architect) will make available all necessary information as requested.

Detailed Description of Services / Statement of Work. The Arborist shall work in cooperation with the District to provide the following:

- A full map of the project site, identifying all trees with a trunk size equal to or greater than 2" at a height of 4' above grade;
- Identification of the species of each tree;
- Identification of the health of each tree;
- Identification of any trees that have roots that project above the surrounding finish grade and whether or not that projection has caused structural defect in any constructed elements such as buildings, roads, retaining walls, curbs or sidewalk;
- Identification of the location of each tree shown graphically except where the tree is located within 10 feet of a structure or where the canopy of the tree overhangs a structure in which case the actual distance from the centerline of the tree to the structure shall be indicated.
- A detailed report including all requirements as specified in the attached Urban Forestry Manual for the city of Tigard and Tualatin land use application

Consultant will be familiar with City Land Use and Zoning codes and shall be qualified to make recommendations to the District on the impacts that site redevelopment may have on significant trees, once the design process is initiated. Any such services would be contracted at a later date under separate agreement.

Schedule. The Work of this Contract shall commence with execution of the contract and shall be completed on or before 17 July, 2017.

Consultant and its employees will be required to notify the district in advanced on when they intend to be onsite and notify staff at the facility during visit.

Tualatin High School Site

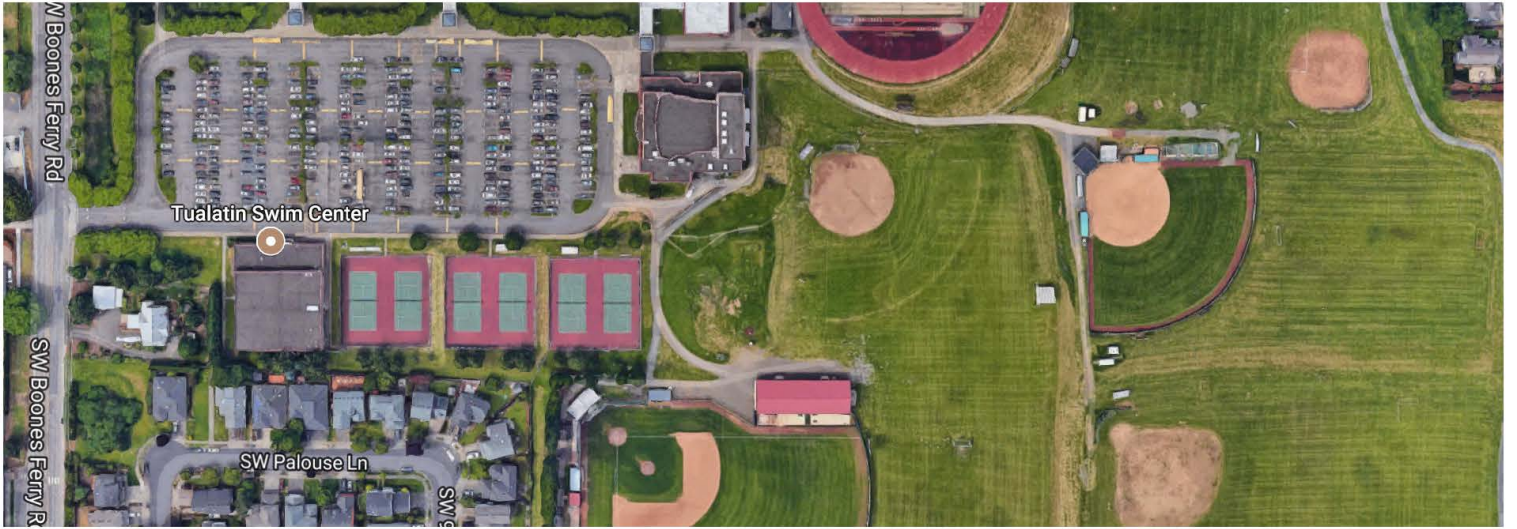

Appendix C - Assumptions & Limiting Conditions

1. Consultant assumes that any legal description provided to Consultant is correct and that title to property is good and marketable. Consultant assumes no responsibility for legal matters. Consultant assumes all property appraised or evaluated is free and clear, and is under responsible ownership and competent management.
2. Consultant assumes that the property and its use do not violate applicable codes, ordinances, statutes or regulations.
3. Although Consultant has taken care to obtain all information from reliable sources and to verify the data insofar as possible, Consultant does not guarantee and is not responsible for the accuracy of information provided by others.
4. Client may not require Consultant to testify or attend court by reason of any report unless mutually satisfactory contractual arrangements are made, including payment of an additional fee for such Services.
5. Unless otherwise required by law, possession of this report does not imply right of publication or use for any purpose by any person other than the person to whom it is addressed, without the prior express written consent of the Consultant.
6. Unless otherwise required by law, no part of this report shall be conveyed by any person, including the Client, the public through advertising, public relations, news, sales or other media without the Consultant's prior express written consent.
7. This report and any values expressed herein represent the opinion of the Consultant, and the Consultant's fee is in no way contingent upon the reporting of a specific value, a stipulated result, the occurrence of a subsequent event or upon any finding to be reported.
8. Sketches, drawings and photographs in this report, being intended as visual aids, are not necessarily to scale and should not be construed as engineering or architectural reports or surveys. The reproduction of any information generated by architects, engineers or other consultants and any sketches, drawings or photographs is for the express purpose of coordination and ease of reference only. Inclusion of such information on any drawings or other documents does not constitute a representation by Consultant as to the sufficiency or accuracy of the information.
9. Unless otherwise agreed, (1) information contained in this report covers only the items examined and reflects the condition of those items at the time of inspection; and (2) the inspection is limited to visual examination of accessible items without dissection, excavation, probing, climbing, or coring. Consultant makes no warranty or guarantee, express or implied that the problems or deficiencies of the plans or property in question may not arise in the future.
10. Loss or alteration of any part of this Agreement invalidates the entire report.

Appendix D – Bibliography & Glossary

Partial Glossary of Terms

Critical root zone (CRZ): Portion of the root system that is the minimum necessary to maintain vitality or stability of the tree. Encroachment or damage to the critical root zone will put the tree at risk of failure.

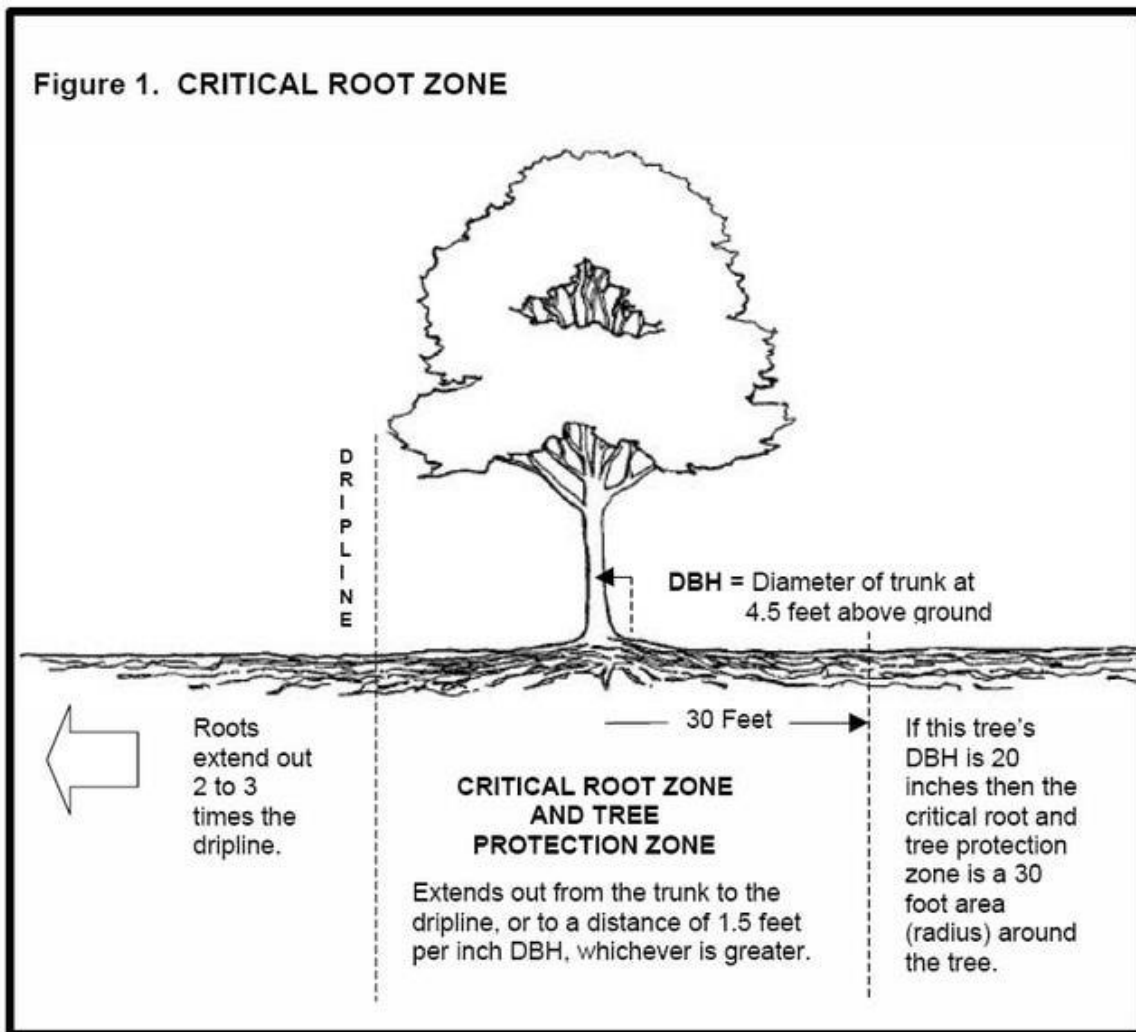

DBH: Diameter at Breast Height, typically measured at four and a half feet from ground level.

Risk: Likelihood or probability that something will happen. Usually associated with negative consequences. In tree management, the likelihood that a tree or tree part will fall and cause injury or damage.

Risk assessment: Process of evaluating what unexpected things could happen, how likely it is, and what the likely outcomes are. In tree management, the systematic process to determine the level of risk posed by a tree, tree part, or group of trees.

Vigor: A measure of the increase in plant growth or foliage volume through time after planting.

OTC Cares

Caring for our environment stems from a deep knowledge of trees. How they work, what keeps them healthy, and knowing when to remove a hazard tree is all part of our training. The International Society of Arboriculture (ISA) sets the industry standard for proper care. Our Certified Arborists are tested and approved by the ISA. With annual education requirements, we stay current in our knowledge and qualifications.



Respectfully Submitted,

Damien Carré – Owner

- Certified Arborist, ISA (PN-6405A)
- Certified Tree Risk Assessor (CTRA 1717)
- Over 17 years' experience in the arboriculture industry
- ISA, PNW-ISA Member, TCIA Member
- PNW-ISA Arborist of The Year 2016
- Ascending the Giants, Board Member; non-profit documenting the champion trees in the Pacific Northwest
- WesSpur, Resident Training Specialist for Aerial Rescue and SRT programs
- PNW-ISA, member representative for course design and setup to the Local, Regional, National and International Climbing Championships

Disclaimer

Arborists are specialists in tree management and care who use their education, knowledge, training and experience to inspect and assess tree health and condition, recommend measures that are likely to enhance the health and beauty of trees, and attempt to identify measures that reduce risk of personal injury or property damage from trees exhibiting defects. Clients may choose to accept or disregard the recommendation of the arborist, or to seek additional advice. Arborists cannot detect every condition that could possibly lead to the structural failure or decline in health of a tree. Trees are living organisms that fail in ways we do not fully understand. Conditions are often hidden within trees and below ground. Arborists cannot guarantee that a tree will be healthy or safe under all circumstances, or for a specified period of time.

Likewise, the response to any remedial treatments, like any medicine, cannot be guaranteed. Treatment, pruning or removal of trees may involve considerations beyond the scope of the Arborist's services such as property boundaries, property ownership, site lines, disputes between neighbors and other issues. Arborists cannot take such considerations into account unless complete and accurate information is disclosed to the Arborist. An Arborist should then be expected to reasonably rely upon the completeness and accuracy of the information provided.

In order to accomplish a full assessment and to produce the best information, historical data on each tree (from past observations and reporting) should be provided in accordance with standard systematic tree assessment practices. OTC sincerely has the interest of not only the tree and the environment in mind, but also the residents.

-END-

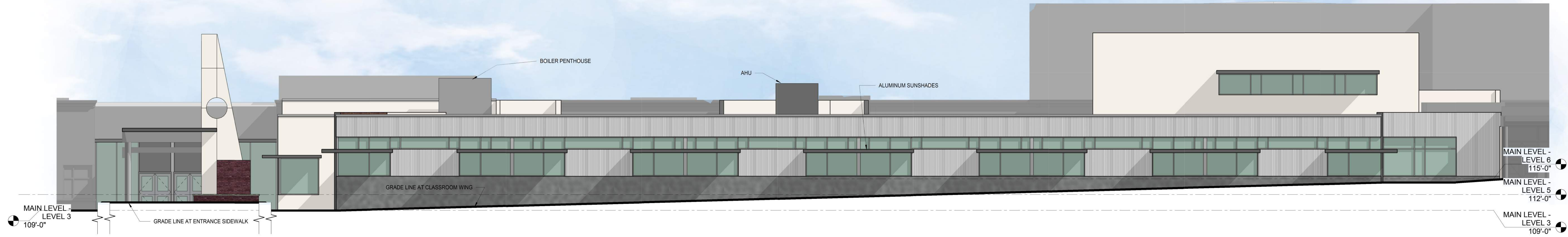

1 SOUTH ADDITION - SOUTH ELEVATION - LU
1/8" = 1'-0"

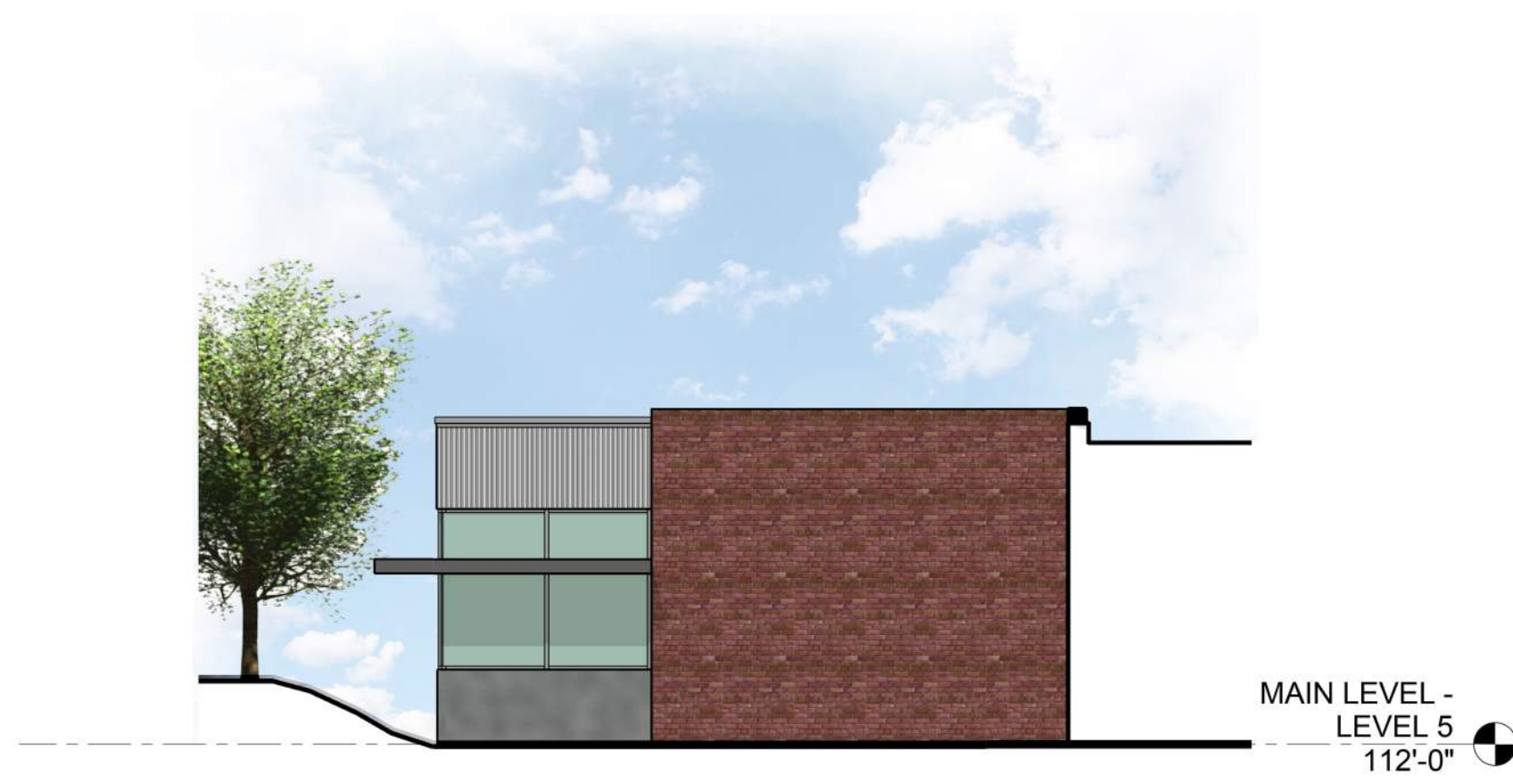

3 SOUTH ADDITION - EAST ELEVATION LU
1/8" = 1'-0"



2 SOUTH ADDITION - WEST ELEVATION LU
1/8" = 1'-0"

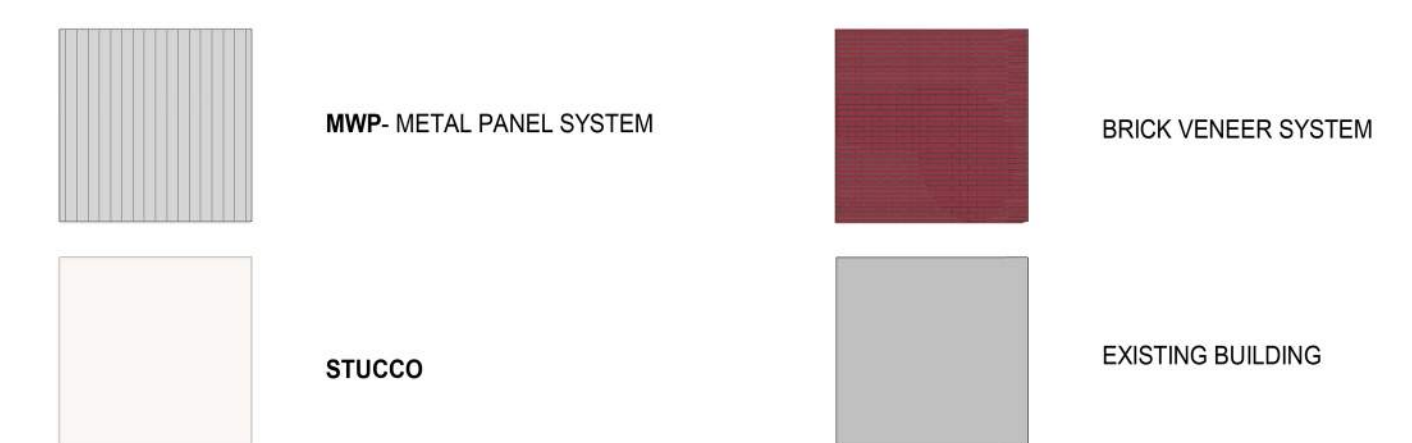

ELEVATION LEGEND

TUALATIN HIGH SCHOOL
RENOVATIONS AND ADDITIONS

#	REVISIONS	DATE
1		
2		
3		
4		
5		

Owner
Tualatin High School

22300 SW Boones Ferry Road
Tualatin, Oregon, Washington County
97062
JOB NO: 16993
ISSUE DATE: 12/13/17
Jurisdiction Stamp Area

OVERALL
BUILDING
ELEVATIONS

LU 1.00

LANDUSE

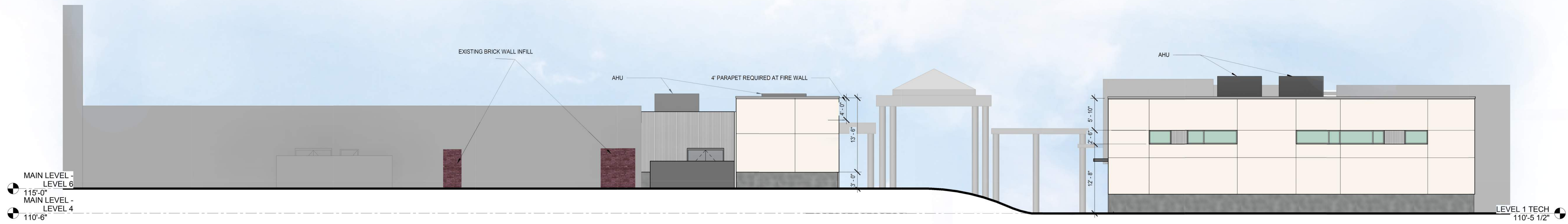

1 LOCKER ROOM ADDITION - EAST ELEVATION LU
1/8" = 1'-0"



2 CTE ADDITION - NORTH ELEVATION LU
1/8" = 1'-0"

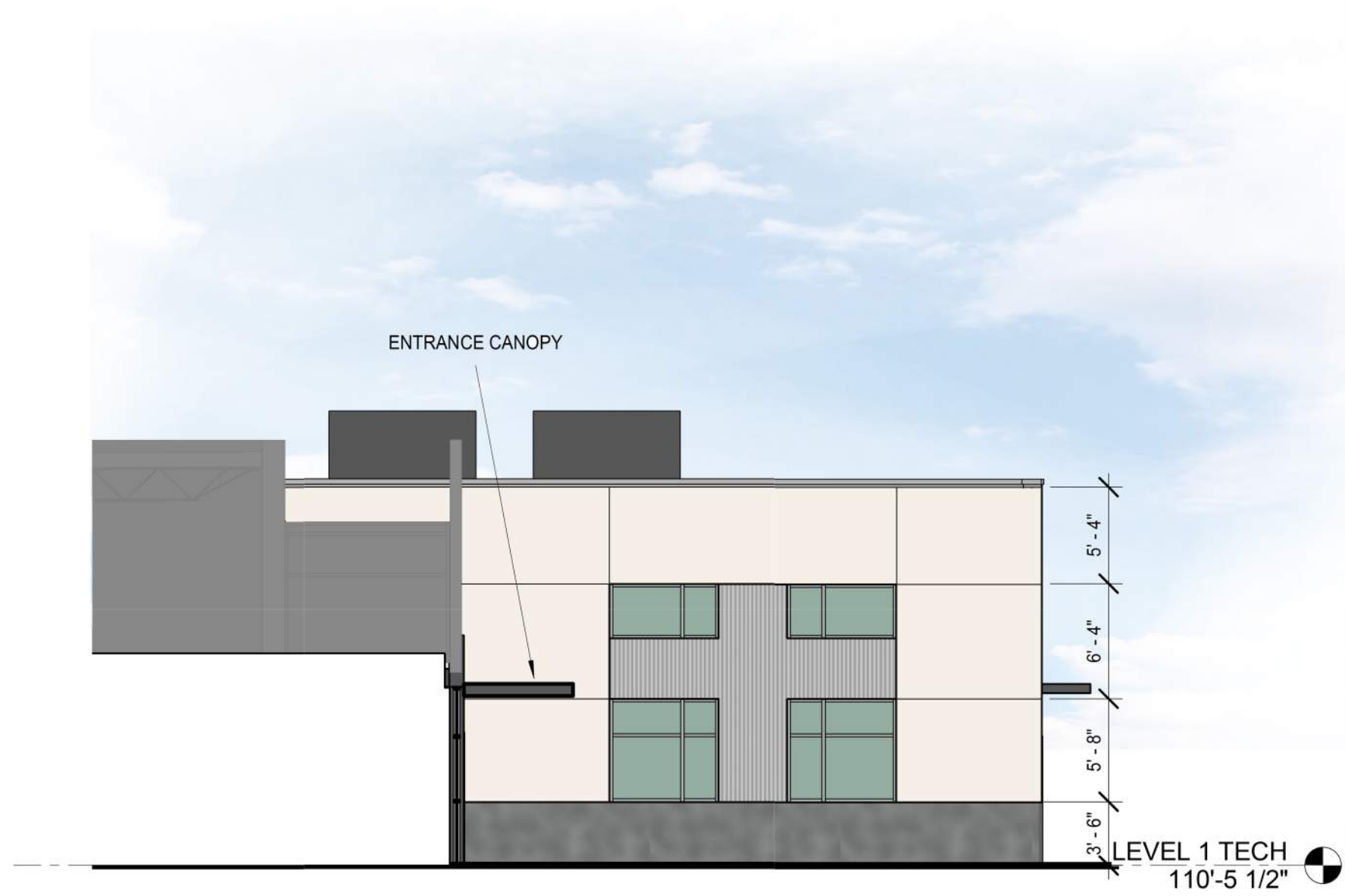

4 CTE ADDITION - WEST ELEVATION LU
1/8" = 1'-0"



3 CTE ADDITION - SOUTH ELEVATION LU
1/8" = 1'-0"

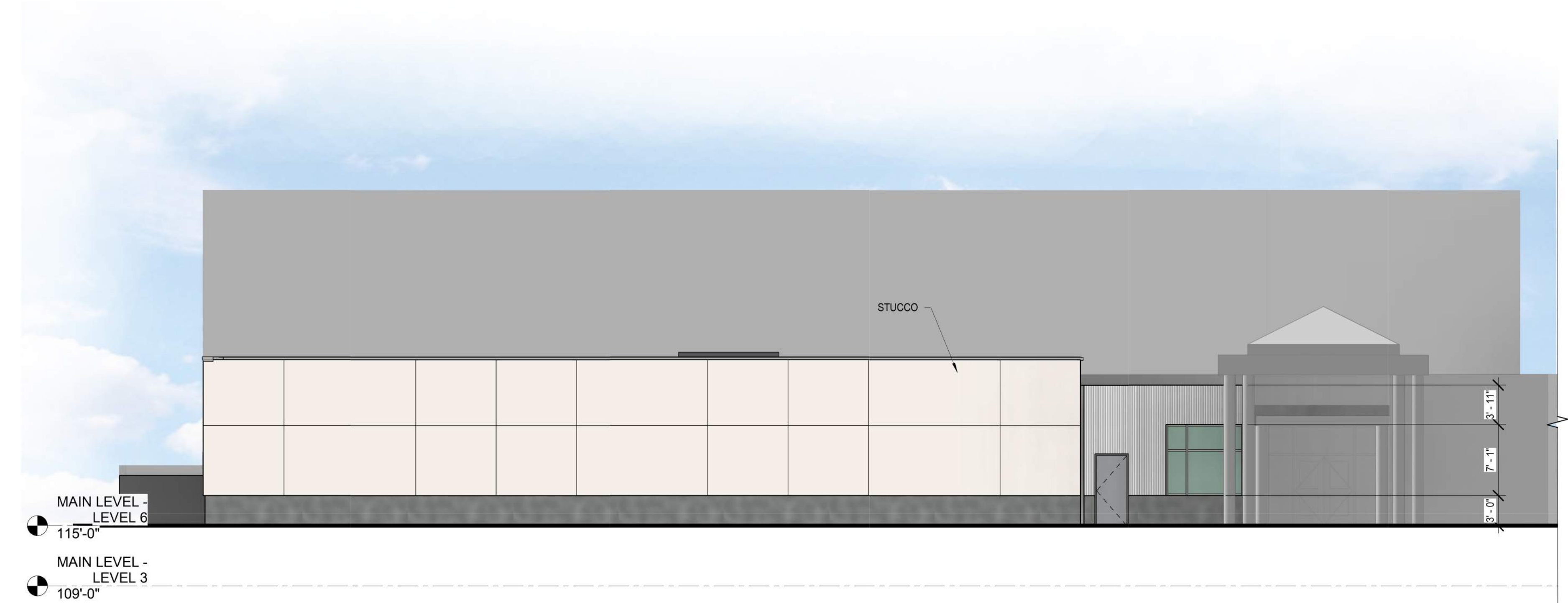

5 LOCKER ROOM AND COMMONS ADDITION - NORTH ELEVATION LU
1/8" = 1'-0"

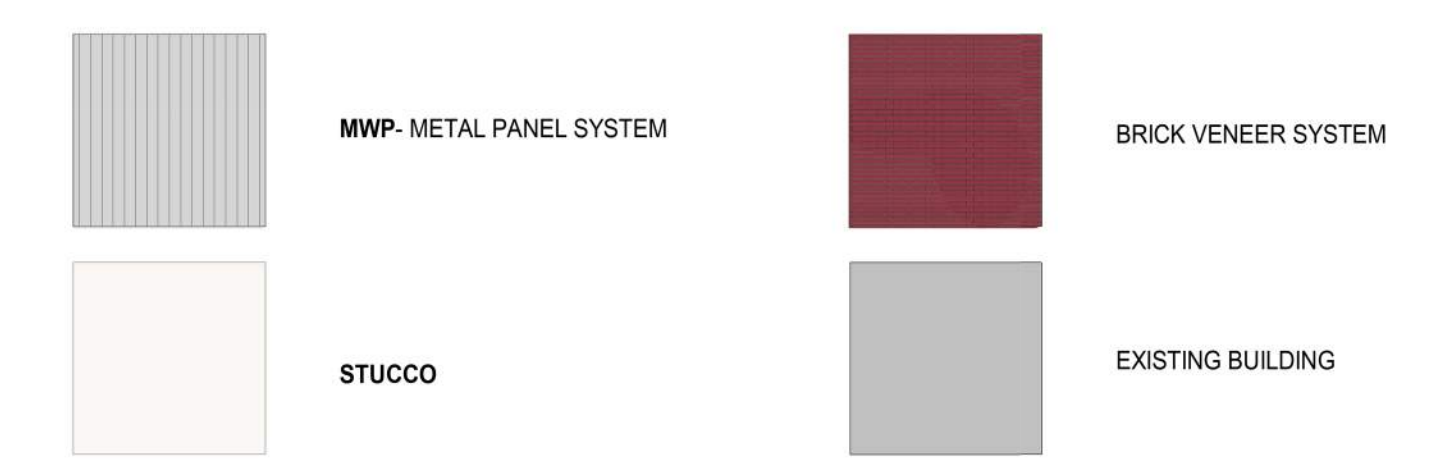

ELEVATION LEGEND

#	REVISIONS	DATE
1		
2		
3		
4		
5		

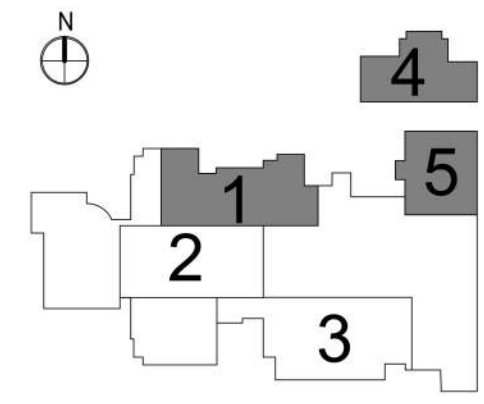

Owner
Tualatin High School

22300 SW Boones Ferry Road
Tualatin, Oregon, Washington County
97062
JOB NO: 16993
ISSUE DATE: 12/13/17
Jurisdiction Stamp Area

OVERALL
BUILDING
ELEVATIONS

LU 2.00

LANDUSE



September 1, 2017

5415 SW Westgate Drive
Suite 100
Portland, Oregon 97221
USA

Phone: (503) 419-2500
Fax: (503) 419-2600

www.cardno.com

RE: Tualatin High School Renovation Project – Pre-Application Narrative

Tualatin City Staff:

Cardno and Day CPM are agents representing the Tigard-Tualatin School District, who is the owner of Tualatin High School in Tualatin, OR. The Tualatin High School property is located at 22300 SW Boones Ferry Road and is legally identified as Parcel 2S135AB00700. The school currently operates as a school, and the owner is proposing to continue the same use as part of a proposed renovation plan. A preliminary plan set is included with this letter conveying existing conditions on the site and the general scope of the proposed renovation. A short list of questions are provided on the City of Tualatin Pre-Application Meeting Request Form. The main areas of clarification requested of City staff by the applicant are: required off-site improvements; AR timeline; key components of design guidelines; storm water issues; fire access; and parking. As part of review by the City of Tigard, an Architectural Review land use application is required prior to building permit review. Prior to applying to the City of Tigard for the necessary land use approvals, a Pre-Application Meeting is required and our team is now prepared to discuss the proposal in more specific details with City staff. A Pre-Screening Meeting for this project was held in April 2017. The contents of this letter is intended to provide more specific background of the proposed project.

The Tualatin High School renovation project is a combination of new additions and interior renovations distributed across the existing school campus. Some exterior plaza renovations are also included as add alternates. Interior renovations are also proposed for existing Commons, Lockers, Library, and existing Administration areas, however, these areas will not affect the project site footprint. The project architect is Bassetti Architects, a firm with an outstanding history in the design of educational facilities.

A new addition of approximately 22,000 SF is proposed along the south perimeter of the school, extending from the south Main Entry east to the existing Fine Arts Wing. This addition consists of a new entry vestibule, administration spaces, classrooms, internal courtyards, and a new fitness room. Minor potential plaza improvements to the existing exterior walkway at the main south entry are currently being explored with the district. A new addition of 2,000 SF is also proposed for the north end of the Commons, along with an add-alternate of 2,000 SF of exterior plaza with overhead canopy extending north of this new Commons addition. At the northeast corner of the school, a 3,700 SF addition of locker rooms and team rooms is proposed at the north end of the existing locker rooms. At the CTE Wing across from Athletics, an addition of 3,200 SF of CTE classroom and Makers Space is proposed at the east end of the existing building. Fire lane access around the NE end of the CTE Wing is currently being evaluated pending confirmation of this new CTE addition footprint. The CTE is the Career Technical Education Wing and is the newer free-standing building at the far NE portion of the site.

We look forward to discussing the proposal with you. If you have any questions prior to the meeting, please call Kevin Brady at Cardno at 503-419-2500, or Cathy Kraus at Day CPM at 503-913-3777.

Sincerely,

Kevin Brady
Senior Planner



5415 SW Westgate Drive
Suite 100
Portland, Oregon 97221
USA

Phone: (503) 419-2500
(503) 419-2500
Fax: (503) 419-2600 (503)
419-2600

www.cardno.com



City of Tualatin

COMMUNITY DEVELOPMENT PLANNING DIVISION

Scoping Meeting Request

The purpose of the Scoping and Pre-Application meetings is to offer early assistance in the land use and permitting process. This includes thoughtful feedback on preliminary design direction and visioning, outlining expectations, and to assist the applicant in attaining a complete application at first submittal.

PROJECT DESCRIPTION

Project name/title: Tualatin High School modifications

What is the primary purpose of this scoping meeting (What would you like to accomplish)? (Attach additional sheets if needed.)

The purpose of the Scoping Meeting is to have staff address potential key issues for required land uses, specifically the Conditional Use and Architectural Review. The hope is to have staff identify potential challenges related to the standards and approval criteria related to each application, including height regulations. We also hope to determine potential schedule timelines for these land use applications.

PROPERTY INFORMATION

Property address: 22300 SW Boones Ferry Road, Tualatin, OR 97062

Tax map and tax lot no.(s): 2S135AB00700 Zoning: RL

PROPERTY OWNER/HOLDER INFORMATION

Name(s): Tigard-Tualatin School District

Contact: David Moore, Business Office Director

Email: dmoore@ttsd.k12.or.us Phone: 503-431-4016

Address: 6960 SW Sandburg Street

City/state: Tigard, OR Zip: 97223

APPLICANT INFORMATION

Name: Day CPM

Address: 12745 SW Beaverdam Road, Suite 120

Phone: 503-641-4100

City/state: Beaverton, OR Zip: 97005

Contact person: Cathy Kraus

Phone: 503-641-4100 Email: ckraus@daycpm.com

Scoping Meeting Information

All of the information identified on this form is required and must be submitted to the Planning Division with this application. Conferences are scheduled subject to availability and a minimum of two weeks after receiving this application and all materials. Scoping meetings are one (1) hour long and are typically held on Mondays between the hours of 3-4 p.m. or Wednesdays between 2-4 p.m.

If more than four (4) people are expected to attend the scoping meeting in your group, please inform the City in advance so that alternate room arrangements can be made to accommodate the group.

REQUIRED SUBMITTAL ELEMENTS

(Note: Requests will not be accepted without the required submittal elements)

A complete application form.

1 hard copy and an electronic set of the following:

- Preliminary site and building plans, drawn to scale, showing existing and proposed features. (Plans do not need to be professionally prepared; just accurate and reliable.)
- A detailed narrative description of the proposal that clearly identifies the location, existing and proposed uses, and any proposed construction.
- A list of all questions or issues the applicant would like the City to address.

FOR STAFF USE ONLY

Case No.: _____

Related Case No.(s): _____

Application accepted:

By: _____ Date: _____

Date of Scoping: _____

Time of Scoping: _____

Planner assigned to Scoping: _____

What type of development are you proposing? (Check all that apply)

Industrial Commercial Residential Institutional Mixed-use

Please provide a brief description of your project: (Attach additional sheets if needed.) Please include description of existing uses and structures in addition to what is proposed.

Based on recent passage of associated bond measure(s), Tualatin High School is proposing to expand and modify the existing high school campus. The scope of this proposal includes:

1. Relocate Administration/Main Office to the South of the Building to create a new public entry and convert existing Admin/Office area into 3 classrooms
2. Expand existing Commons Area
3. Consolidate Special Education classrooms, Special Ed. offices and upgrade toilet rooms
4. Expand Tech Wing to include a new Maker Space
5. New addition for 12 Classrooms
6. Expand Locker rooms, Team rooms and build a Multi-use Fitness space
7. New synthetic turf surfaced Multi-Purpose sports field
8. No new increase in student capacity

Are you familiar with the development process in Washington or Clackamas County or Tualatin?

Yes No

If yes, please identify an example project:

Nyberg Rivers Center, Tualatin River Greenway Trail, Tualatin Code Rewrite Project _____

Are you familiar with the sections of the Tualatin Development Code (TDC) that pertain to your proposed development?

Yes No

Is the property under enforcement action? If yes, please attached a notice of the violation.

Yes No

Please provide the names of City, TVF&R, CWS, and County staff with whom you have already discussed this proposal:

Erin Engman, City of Tualatin _____



City of Tualatin

COMMUNITY DEVELOPMENT PLANNING DIVISION

Pre-Application Meeting Request

The purpose of the Scoping and Pre-Application meetings is to offer early assistance in the land use and permitting process. This includes thoughtful feedback on preliminary design direction and visioning, outlining expectations, and to assist the applicant in attaining a complete application at first submittal.

PROJECT DESCRIPTION

Project name/title: Tualatin High School

What is the primary purpose of this pre-application meeting (What would you like to accomplish)? (Attach additional sheets if needed.)

Applicant team would like specific development standards and criteria to be addressed during Architectural Review, including those related to landscaping, parking/loading, pedestrian network and height. Applicant team would like all off-site improvement requirements indicated, including right-of-way improvements. Applicant would like storm water system requirements clarified.

Applicant team would like to have specific durations indicated for both land use and building permit application review.

PROPERTY INFORMATION

Property address/location(s): Tualatin High School
22300 SW Boones Ferry Rd, Tualatin, OR 97062

Tax map and tax lot no.(s): 2S135AB00700

Zoning: RL

PROPERTY OWNER/HOLDER INFORMATION

Name(s): Tigard-Tualatin School District

Address: 6960 SW Sandburg St. Phone: 503 431-4000

City/state: Tigard, Oregon Zip: 97223

APPLICANT INFORMATION

Name: Day CPM

Address: 12745 SW Beaverton Road, Suite 120 Phone: 503 641-4100

City/state: Beaverton, Oregon Zip: 97005

Contact person: Cathy Kraus, Project Manager

Phone: 503-641-4100 Email: ckraus@DayCPM.com

Pre-application Conference Information

All of the information identified on this form is required and must be submitted to the Planning Division with this application. Conferences are scheduled subject to availability and a minimum of two weeks after receiving this application and all materials. Pre-application conferences are one (1) hour long and are typically held on Mondays between the hours of 3-4 p.m. or Wednesdays between 2-4 p.m.

If more than four (4) people are expected to attend the pre-application conference in your group, please inform the City in advance so that alternate room arrangements can be made to accommodate the group.

REQUIRED SUBMITTAL ELEMENTS

(Note: Requests will not be accepted without the required submittal elements)

- A complete application form and accompanying fee.
- 1 hard copy and an electronic set of the following:**
 - Preliminary site and building plans, drawn to scale, showing existing and proposed features. (Plans do not need to be professionally prepared; just accurate and reliable.)
 - A detailed narrative description of the proposal that clearly identifies the location, existing and proposed uses, and any proposed construction.
 - A list of all questions or issues the applicant would like the City to address.

FOR STAFF USE ONLY

Case No.: _____

Related Case No.(s): _____

Application fee: _____

Application accepted: _____

By: _____ Date: _____

Date of pre-app: _____

Time of pre-app: _____

Planner assigned to pre-app: _____

What type of development are you proposing? (Check all that apply)

Industrial Commercial Residential Institutional Mixed-use

Please provide a brief description of your project: (Attach additional sheets if needed.) Please include description of existing uses and structures in addition to what is proposed.

Based on recent passage of associated bond measure(s), Tualatin High School is proposing to expand and modify the existing high school campus. The scope of this proposal includes; Relocate Administration/Main Office to the South of the Building to create a new public entry and convert existing Admin/Office area into 3 classrooms, Consolidate Special Education classrooms, Special Ed. offices and upgrade toilet rooms, Expand Tech Wing to include a new Maker Space, New addition for 12 Classrooms, Expand Locker rooms, Team rooms and build a Multi-use Fitness space, New synthetic turf surfaced Multi-Purpose sports feild, No new increase in student capacity.

Are you familiar with the development process in Washington or Clackamas County or Tualatin?

Yes No

If yes, please identify an example project:

Nyberg Rivers Center, Tualatin River Greenway Trail, Tualatin Code Rewrite Project

Are you familiar with the sections of the Tualatin Development Code (TDC) that pertain to your proposed development?

Yes No

Is the property under enforcement action? If yes, please attached a notice of the violation.

Yes No

Please provide the names of City, TVF&R, CWS, and County staff with whom you have already discussed this proposal:

Erin Engman, Charles Benson and Tony Doran, City of Tualatin.



City of Tualatin

www.tualatinoregon.gov

Tualatin High School Modifications (SC17-0013) Architectural Review (AR) Suggested Narrative Outline

I. Introduction

- A. Project Description**
- B. Site Description**
- C. Project Schedule**

II. Suggested TDC Sections/Standards to Address

- A. Planning District Usesⁱ**
- B. Lot Sizesⁱⁱ**
- C. Setback Requirementsⁱⁱⁱ**
- D. Structure Height^{iv}**
- E. Development Review Approval—TDC 73.050**
- F. Landscape and Building Maintenance—TDC 73.100**
- G. Site Planning—TDC 73.160 Standards**
- H. Structure Design—TDC 73.220**
- I. Mixed Solid Waste and Source Separated Recyclables Storage Areas—TDC 73.227**
- J. Landscaping**
 - 1. TDC 73.240—General Provisions^v**
 - 2. TDC 73.260—Tree and Plant Specifications**
 - 3. TDC 73.280—Irrigation System Required**
 - 4. TDC 73.290—Re-vegetation in Un-landscaped Areas**
 - 5. TDC 73.310—Landscape Standards - Commercial, Industrial, Public and Semi-Public Uses^{vi}**

6. **TDC 73.340—Off-Street Parking Lot and Loading Area Landscaping – Commercial, Industrial, Public and Semi-Public Uses, and Residential and Mixed Use Residential within the Central Design District^{vii}**
7. **TDC 73.360—Off-Street Parking Lot Landscape Islands – Commercial, Industrial, Public, and Semi-Public Uses^{viii}**
8. **TDC 73.410—Street Tree Plan**

K. Tree Removal and Preservation

1. **TDC 34.210—Application for Architectural Review, Subdivision or Partition Review, or Tree Removal Permit^{ix}**
2. **TDC 34.230—Tree Removal Criteria**
3. **TDC 73.250—Tree Preservation**

L. Grading

1. **TDC 73.270—Grading**
2. **TDC Chapter 70—Floodplain District (FP)^x**
3. **TDC Chapter 71—Wetlands Protection District (WPD)^{xi}**
4. **TDC Chapter 72—Natural Resource Protection Overlay District (NRPO)^{xii}**

M. Off-Street Parking and Loading

1. **TDC 73.370—Off-Street Parking and Loading**
2. **TDC 73.380—Off-Street Parking Lots**
3. **TDC 73.390—Off-Street Loading Facilities**

ⁱ Refer to Permitted Uses section of the subject planning district.

ⁱⁱ Refer to Lot Size for Permitted Uses section of the subject planning district.

ⁱⁱⁱ Refer to Setback Requirements for Permitted Uses section of the subject planning district.

^{iv} Refer to Structure Height section of the subject planning district.

^v As applicable.

^{vi} As applicable.

^{vii} As applicable.

^{viii} As applicable.

^{ix} Only needed if proposal includes trees to be removed and/or retained and no arborist report included in application.

^x If applicable; confer with Engineering Division.

^{xi} If applicable, confer with Engineering Division.

^{xii} If applicable, confer with Engineering Division and Community Services Department.

TUALATIN HIGH SCHOOL

Tualatin, Oregon

An Application For:

Architectural Review

Resubmitted December 18, 2017

Applicant:

Tigard Tualatin School District

Agent: Day CPM

12745 SW Beaverdam Road, #120

Beaverton, OR 97005

Phone: 503-641-4100

Contact: Cathy Kraus

ckraus@daycpm.com

Prepared by:

Cardno

6720 SW Macadam Avenue, Suite 200

Portland, Oregon 97219

Phone: 503-419-2500

Contact: Kevin Brady

kevin.brady@cardno.com

TABLE OF CONTENTS

INTRODUCTION.....	6
Project summary	7
_Toc496766946	
TDC CHAPTER 31: GENERAL PROVISIONS.....	9
Section 31.020 Classification of Planning District.....	9
Section 31.063 Neighborhood/ Developer Meetings.	9
Section 31.064 Land Use Applications.	9
TDC CHAPTER 40: LOW DENSITY RESIDENTIAL.....	12
PLANNING DISTRICT (RL).....	12
Section 40.030 Permitted Uses.....	12
Section 40.060 Lot Sizes.	12
Section 40.080 Setback Requirements for Conditional Uses	13
Section 40.100 Structure Height	13
Section 40.110 Access.....	13
Section 40.120 Off-Street Parking and Loading	13
Section 40.140 Community Design Standards	14
Section 40.150 Landscape Standards	14
TDC CHAPTER 73: COMMUNITY DESIGN STANDARDS	14
Section 73.050 Criteria and Standards	14
Section 73.100 Landscaping Installation and Maintenance.....	18
Section 73.160 Standards.....	18
Section 73.220 Standards.....	20
Section 73.227 Standards.....	21
Landscaping	22
Section 73.240 Landscaping General Provisions.	22
Section 73.260 Tree and Plant Specifications	23
Section 73.280 Irrigation System Required.	24
Section 73.290 Re-vegetation in Un-landscaped Areas	24
Section 73.310 Landscape Standards - Commercial, Industrial, Public and Semi-Public Uses.	25
Section 73.340 Off-Street Parking Lot and Loading Area Landscaping	25
Section 73.360 Off-Street Parking Lot Landscape Islands.....	25
Section 73.410 Street Tree Plan	25
Tree removal and preservation.....	26
Section 34.210 Application for Architectural Review, Sub-division or Partition Review, or Tree Removal Permit.....	26
Section 34.230 Tree Removal Criteria	27
Section 73.250 Tree Preservation.....	27

Grading	28
Section 73.270 Grading	28
TDC Chapter 70: Flood Plain District (FP).....	28
TDC Chapter 71: Wetlands Protection District (WPD).....	28
TDC Chapter 72: Natural Resource Protection Overlay District (NRPO)	28
Off-street parking and loading.....	29
Section 73.370 Off-Street Parking and Loading	29
Section 73.380 Off-Street Parking Lots.	30
Section 73.390 Off-Street Loading Facilities.....	30
 TDC CHAPTER 74: PUBLIC IMPROVEMENT REQUIREMENTS.....	 31
Right-of-way.....	32
Section 74.210 Minimum Street Right-of-Way Widths.....	32
Transportation	32
Section 74.420 Street Improvements.....	32
Section 74.425 Street Design Standards.....	32
Section 74.430 Streets, Modifications of Requirements	34
Section 74.440 Streets, Traffic Study Required.....	35
Section 74.470 Street Lights	35
Utilities	36
Section 74.630 Storm Drainage System.....	30
Section 74.640 Grading.	30
Section 74.650 Water Quality, Storm Water Detention and Erosion Control	30
 TDC CHAPTER 75: ACCESS MANAGEMENT	 37
Access management.....	37
Section 75.120 Existing Streets	37
 TMC CHAPTERS 3 AND 4.....	 38
 CONCLUSION	 41

EXHIBITS

- Exhibit A AR Application Form and City Fact Sheet
- Exhibit B Plan Set
- Exhibit C Title Report and Tax Map
- Exhibit D CWS Service Provider Letter
- Exhibit E Neighborhood Meeting Materials
- Exhibit F Storm Report
- Exhibit G Soils Report
- Exhibit H Traffic Report
- Exhibit I Arborist Report
- Exhibit J Elevations
- Exhibit K Pre-Application/Scoping Materials
- Exhibit L Written Narrative

INTRODUCTION

GENERAL INFORMATION

**Applicant/
Owner:** Tigard Tualatin School District
Owner Agent: Day CPM
12745 SW Beaverdam Road, #120
Beaverton, OR 97005
Phone: 503-641-4100
Contact: Cathy Kraus
ckraus@daycpm.com

**Applicant's
Agent:** Cardno
6270 SW Macadam Avenue, Suite 200
Portland, Oregon 97219
(503) 419-2500 phone
Contact: Kevin Brady
Email: kevin.brady@cardno.com

**Tax Lot
Information:** 2S135AB00700

Location: 223000 SW Boones Ferry Road
Tualatin, Oregon 97062

Current Zoning: RL - Low Density Residential

PROJECT SUMMARY

PROJECT DESCRIPTION

The Tualatin High School renovation project is a combination of new additions and interior renovations distributed across the existing school campus. Some exterior plaza renovations are also included as add alternates. Interior renovations are also proposed for existing Commons, Lockers, Library, and existing Administration areas, however, these areas will not affect the project site footprint. The project architect is Bassetti Architects, a firm with an outstanding history in the design of educational facilities.

A new addition of approximately 16,600 SF is proposed along the south perimeter of the school, extending from the south Main Entry east to the existing corridor near the Auditorium. This addition consists of a new entry vestibule, administration spaces, classrooms, (2) internal courtyards, and a new fitness room. Minor potential plaza improvements to the existing exterior walkway at the main south entry are currently being explored with the district. A new extension of 2,000 SF is also proposed for the north end of the Commons, along with an add-alternate addition of 2,000 SF of open canopy and exterior plaza extending north of the new Commons addition. At the northeast corner of the school, the locker rooms and team rooms will be renovated and enlarged with a 3,700 SF addition. The separate CTE Building across from the Athletics area, will be enlarged with an addition of 3,200 SF of CTE classroom and Makers Space at the east end of the existing structure. CTE is the Career Technical Education center and is a free-standing building at the far NE portion of the site. Fire lane access is rerouted around the expanded CTE building. Additionally, Fire access will be provided around the south side of the auditorium.

Additionally, the applicant is looking to make improvements to the athletic fields on the east side of campus. This primarily consists of replacing three existing natural grass fields with synthetic turf, including varsity baseball and softball plus a multi-use practice field. Serving the fields will be improved ADA access. Plus, a pole barn is proposed for softball batting cages and limited storage.

There are no new increases in student enrollment or staff anticipated as part of this proposal, and no measurable increase in student, staff, or bus trips are anticipated beyond existing conditions.

SITE DESCRIPTION

The site generally slopes from east to west and drops almost 60' from the east boundary to SW Boones Ferry Road. The site slopes up from the street and the existing buildings are generally 6' to 10' above public street access on the west side. Grade continues to climb heading east toward the sport fields. The northeast corner slopes away again from the sport fields toward existing residential development. There are two vehicular points of entry off SW Boones Ferry Road – one to the north parking lot and one to the south parking lot. Each driveway has a right and left turn egress and one ingress lane. SW Boones Ferry Road fronts the campus on the west side. The road is built out with curb, curb-tight sidewalk, and street trees.

TDC CHAPTER 31: GENERAL PROVISIONS

Section 31.020 Classification of Planning District.

In order to carry out the objectives of the Tualatin Community Plan, land within the City is divided into planning districts. The established planning districts shall be designated on the Plan Map, and the planning district designations shall be as follows:

Planning District	Abbreviated Designation
Low Density Residential	RL

Response: As shown on the City of Tualatin zoning map, the subject site is within the RL Planning District. Therefore, this narrative will address all applicable code regulations pertaining to the RL Planning District.

Section 31.063 Neighborhood/ Developer Meetings.

- (1) This section applies to the following types of Land Use applications: Annexations; Architectural Reviews, except Level I (Clear and Objective) Single-family Architectural Review; Conditional Uses; Historic Landmark actions, including designation, removal of designation, demolition, relocation, or alteration or new construction: Industrial Master Plans; Partitions; Plan Map Amendments for a specific property; Plan Text Amendments for a specific property; Subdivisions; Tree Removal Permit; Transitional Use Permit; and Variances, except for variances to existing single family residences.

Response: A neighborhood meeting for this proposal was held on October 5th, 2017 from 6 to 7 p.m. at the Tualatin High School Library located at 22300 SW Boones Ferry Road in Tualatin. Notice to adjacent property owners and the Community Involvement Organizations (CIOs) was sent out on September 21, 2017 and a notice sign was posted on-site to meet the 14 calendar day notice requirements. An additional neighborhood meeting was held on November 15th, with compliance of all requirements for noticing and posting met. This additional meeting was focused on the athletic fields, and was part of a series of 3 additional neighborhood meetings focused on the athletic fields. All neighborhood meeting material and affidavits of mailing and postings are provided in Exhibit E.

Section 31.064 Land Use Applications.

This section applies to the following types of Land Use applications: Annexations; Architectural Reviews, except Level I (Clear and Objective) Single-family Architectural Review; etc.

- (1) **Mail:** An applicant shall mail notice of a Neighborhood/Developer Meeting and the City shall mail notice of application submittal as follows:
- (a) **Recipients:** The mailing recipients shall be the applicant, the owners of the subject property, owners of property within the Mailing Area of TDC 31.064(1)(c) recognized neighborhood associations as defined in TDC 31.060 recognized through TDC 31.065 and within the Mailing Area of TDC 31.064(1)(c), and designated representatives of recognized Citizen Involvement Organizations as established in TMC Chapter 11-9.
 - (b) **Recipient Identification:** The City shall use the names and addresses of the owner or owners of record as shown in the current, or within thirty (30) days of a completed application, computer roll of the County Assessor. The applicant shall be responsible for having one of the following prepare the list: a land title company; a land use planning consultant authorized by the State of Oregon to conduct business in the state; a registered architect, landscape architect, engineer, surveyor, or attorney; or where the City is the applicant, the Community Development Director or when applicable the City Engineer. The applicant shall update the list of property owners no less than every ninety (90) days until a final land use decision is rendered. The applicant shall provide a copy of the list of recipients and their current mailing addresses as part of the land use application.
 - (c) **Mailing Area, Buffer, or Distance:** The mailing area shall extend 1,000 feet from the boundaries of the subject property. If the 1,000-foot area includes lots within a platted residential subdivision, the notice area shall extend to include the entire subdivision of which the lots are part, and the applicant shall identify these subdivisions for staff as part of the mailing notification list.
 - (d) **ARB:** The notice of application submittal for an Architectural Review application subject to review by the Architectural Review Board (ARB) shall have the minimum information pursuant to TDC 31.074(3).

Response: As this project involves an Architectural Review application, the requirements for mailing and sign posting for development applications apply. For the Neighborhood/Developer Meeting, notices to adjacent property owners and the CIOs were sent out by the applicant's agent on September 21st, 2017 and a notice sign was posted on-site that same day to meet the 14 calendar day notice requirements. An additional neighborhood meeting was held on November 15th, with compliance of all requirements for noticing and posting met. This additional meeting was focused on the athletic fields, and was part of a series of 3 additional neighborhood meetings focused on the athletic fields. All neighborhood meeting material and affidavits of mailing and postings are provided in Exhibit E. The applicant's agent has also posted the site on the same day that the application was submitted.

(2) Sign Posting: The applicant shall as follows both provide and post on the subject property a sign that conforms to the standard design established by the City for signs notifying the public of land use actions:

- (a) Minimum Design Requirements: The sign shall be waterproof, and the face size shall be eighteen (18) by twenty-four (24) inches (18 x 24) with text being at least two (2) inches tall.**
- (b) On-site Placement: Prior to land use application submittal, the applicant shall place a sign along the public street frontage of the subject property or, if there is no public street frontage, along the public right-of-way (ROW) of the street nearest the subject property. A subject property having more than one public street frontage shall have at least one posted sign per frontage with each frontage having one sign.**

For a subject property that has a single frontage that is along a dead-end street, the applicant shall post an additional sign along the public ROW of the nearest through street. The applicant shall not place the sign within public ROW pursuant to TDC 38.100(1); however, for a subject property that has no public street frontage or that has a single frontage that is along a dead-end street, the applicant may place the sign within public ROW of the nearest street.

- (c) Proof of Posting: The applicant shall submit as part of the land use application submittal an affidavit of posting to the Community Development Director or when applicable the City Engineer.**
- (d) Removal: If the sign disappears prior to the final decision date of the subject land use application, the applicant shall replace it within forty-eight (48) hours. The applicant shall remove the sign no later than fourteen (14) days after the City makes a final decision on the subject land use application.**

Response: As this project involves an Architectural Review application, the requirements for mailing and sign posting for development applications apply. Notices of application will be sent to adjacent property owners and the CIOs by the City. The site was posted on October 26, 2017 and an affidavit of posting has been provided with this application package. An additional neighborhood meeting was held on November 15th, with compliance of all requirements for noticing and posting met. This additional meeting was focused on the athletic fields, and was part of a series of 3 additional neighborhood meetings focused on the athletic fields. All neighborhood meeting material and affidavits of mailing and postings are provided in Exhibit E.

TDC CHAPTER 40: LOW DENSITY RESIDENTIAL PLANNING DISTRICT (RL)

Section 40.030 Permitted Uses.

The following uses and their accessory uses are permitted as conditional uses when authorized in accordance with TDC Chapter 32:

- (f) Kindergarten through grade 12 school.**

Response: The existing and proposed use of the subject site is Tualatin High School, which is an existing Conditional Use. Staff has indicated that based on the scope of the proposal, there is no requirement for an additional Conditional Use application.

Section 40.060 Lot Sizes.

Except as otherwise provided, the lot size for conditional uses shall be:

- (1) The minimum lot area shall be 6,000 square feet, excepting secondary condominium lots as approved through the Architectural Review process and lots for public utility facilities.**

Response: The existing lot area of the subject site is 2,817,461 square feet, therefore, the minimum lot area is met. There are no proposals for land divisions as part of this application or proposal.

- (2) The average lot width shall be at least 60 feet, excepting secondary condominium lots as approved through the Architectural Review process and lots for public utility facilities.**

Response: The average lot width of the subject site is 1938 feet, therefore, the average lot width of 60 feet is met.

- (3) When a lot has frontage on a public street, the minimum lot width shall be 50 feet on a street and 30 feet around a cul-de-sac bulb, excepting secondary condominium lots as approved through the Architectural Review process and lots for public utility facilities.**

Response: The frontage along SW Boones Ferry Road is 996 feet and the frontage on SW Martinazzi Avenue is 270 feet, therefore, the minimum lot frontage along public street frontages is met.

- (4) The maximum building coverage on a lot shall be 40 percent, excepting secondary condominium lots as approved through the Architectural Review process and lots for public utility facilities.**

Response: The building coverage proposed in this application is 9%, therefore, the maximum building coverage for this proposal is met.

Section 40.080 Setback Requirements for Conditional Uses

(1) Except as otherwise provided, the setbacks for conditional uses shall be as determined and approved through the Architectural Review process. However, no setback greater than 50 feet may be required. Off-street parking and vehicular circulation areas shall be set back a minimum of ten feet from any public right-of-way or property line.

Response: The proposal does not include any additions or renovations that would reduce or increase proposed setbacks significantly. The main existing high school building that is proposed for some additions and renovations is at the center of a large site, with setbacks averaging over 100 feet.

(2) Setback requirements for small lot subdivisions shall comply with the setback requirements for permitted uses as set forth in TDC 40.070.

Response: The proposal does not include a small lot subdivision, therefore, this standard does not apply.

Section 40.100 Structure Height

Except as otherwise provided, the maximum structure height is 35 feet.

Response: As part of the existing Conditional Use, the existing maximum building height is 34 feet and the proposed maximum height for all work associated with this project is 23 feet.

Section 40.110 Access

Refer to TDC 36.470 and 73.400.

Response: Existing site access is not proposed for any alterations and no alterations are required. The existing north and south access ways will continue to operate with the existing design, including access locations and dimensions. This is based on input from City staff in email communicate and in the Pre-Application Conference meeting. No subdivisions or partitions are proposed as part of this application, therefore, TDC 36.470 does not apply.

Section 40.120 Off-Street Parking and Loading

Refer to TDC 73.370

Response: The proposal does not include any new student enrollment or increases in staff. There are no changes proposed for the existing parking areas, including no increases nor decreases in the amount of parking. The current parking lot areas provide adequate ADA parking and are included in the Existing Conditions Plan in the Plan Set, Exhibit B.

Section 40.140 Community Design Standards

(1) Development of the following is subject to the provisions set forth in TDC 40.140(2) and standards and criteria set forth in TDC Chapter 73, in addition to all other applicable TDC standards:

Response: The applicant is not proposing single-family dwelling development, therefore, this Section does not apply. However, the applicant is proposing 'major exterior remodeling', which is germane to Chapter 73.040, Architectural Review Plan Approval Required. This Section of Chapter 73 is addressed below.

Section 40.150 Landscape Standards

Refer to TDC Chapter 73, Community Design Standards. See below.

TDC CHAPTER 73: COMMUNITY DESIGN STANDARDS

(1) Except for an addition or alteration to an existing single-family dwelling when it results in less than a 35% expansion of the structure's existing footprint or less than a 35% alteration of an existing wall plane or only affects the wall plane of the side of the dwelling located in a side yard where the side yard of the dwelling abuts the side yard of an adjacent dwelling, as permitted by these standards, no new building, condominium, townhouse, single family dwelling, addition or alteration to an existing single-family dwelling when it results in a 35% or more expansion of the structure's existing footprint or a new second or higher story or a 35% or more alteration of an existing wall plane (except for the wall plane of a side of the dwelling located in a side yard where the side yard of the dwelling abuts the side yard of an adjacent dwelling), manufactured dwelling park, small-lot subdivision, landscape improvement (excluding greenways, parks and other Parks and Recreation Department road side improvements), parking lot improvement or expansion, above ground public utility facility (sewer or water pump stations, pressure reading stations and water reservoir), electrical substation, above ground natural gas pumping station, installation of decorative lighting (e.g. neon), exterior painting, awnings, murals, wireless communication facility, attached wireless communication facility or exterior major remodeling shall occur until the architectural review plan required under TDC 31.071 has been reviewed and approved by the Community Development Director and City Engineer or their designees, or by the Architectural Review Board or City Council for conformity with applicable standards or criteria.

Response: The proposal does include 'exterior major remodeling', therefore the project is subject to the requirements of Chapter 73, Community Design Standards and Architectural Review.

Section 73.050 Criteria and Standards

(1) In exercising or performing his or her powers, duties, or functions, the Community Development Director shall determine whether there is compliance with the following:

(a) The proposed site development, including the site plan, architecture, landscaping, parking and graphic design, is in conformance with the standards of this and other applicable City ordinances insofar as the location, height, and appearance of the proposed development are involved;

Response: The proposal does not include any significant changes to the overall footprint on the site. The proposed use as a high school will be retained. The application package includes a plan set and architectural elevations demonstrating compliance with all applicable standards of the TDC. These documents depict the location, height and appearance of the proposed renovation and additions proposed at specific locations of the building. All applicable standards of the TDC are addressed specifically in this narrative, with references to the plan set and other documents in this application package. The narrative and application package adequately demonstrate compliance with all applicable standards.

(b) The proposed design of the development is compatible with the design of other developments in the general vicinity; and

Response: The overall location, design and layout of the school is not changing significantly. Those portions of the site proposed for changes are depicted in the plan set and in the architectural elevations. These changes are relatively minor alterations and are designed to continue the general scale of the high school building. Height increases are minimal, with an existing height of 34 feet and a proposed maximum height of 23 feet. Proposed design features are further specified in Exhibit J, Elevations and Predesign Report produced by Bassetti Architects. The existing and proposed design elements are compatible with those design elements of other similar uses and development, including the nearby Edward Byrom Elementary School. These design elements and scale of the proposal are also compatible with the typical school in a low density neighborhood.

(c) The location, design, size, color and materials of the exterior of all structures are compatible with the proposed development and appropriate to the design character of other developments in the vicinity.

Response: The overall location, design and layout of the school is not changing significantly. Those portions of the site proposed for changes are depicted in the plan set and in the architectural elevations. These changes are relatively minor alterations and are designed to continue the general scale of the high school building. Height increases are minimal, with an existing height of 34 feet and a proposed maximum height of 23 feet. Proposed design features are further specified in Exhibit J, Elevations and Predesign Report produced by Bassetti Architects. The existing and proposed design elements are compatible with those design elements of other similar uses and development, including the nearby Edward Byrom Elementary School. These design elements and scale of the proposal are also compatible with the typical school in a low density neighborhood.

- (2) In making his or her determination of compliance with the above requirements, the Community Development Director shall be guided by the objectives and standards set forth in this chapter. If the architectural review plan includes utility facilities or public utility facilities, then the City Engineer shall determine whether those aspects of the proposed plan comply with applicable standards.**

Section 73.020 Findings and Objectives for the Architectural Review Process.

- (2) The City Council declares that the purposes and objectives of community design standards are to:**

- (a) Encourage originality, flexibility and innovation in site planning and development, including the architecture, landscaping and graphic design of development.**
- (b) Discourage monotonous, drab, unsightly, dreary and inharmonious development.**
- (c) Promote the City's natural beauty and visual character and charm by ensuring that structures and other improvements are properly related to their sites, and to surrounding sites and structures, with due regard to the aesthetic qualities of the natural terrain, natural environment, and landscaping. Exterior appearances of structures and other improvements should enhance these qualities.**
- (d) Encourage site planning and development to incorporate bikeways, pedestrian facilities, greenways, wetlands, and other natural features of the environment and provide incentives for dedication of access easements and property to the public through shift of residential density, system development charge credits, landscaping credits and setback allowances.**
- (e) Protect and enhance the City's appeal to tourists and visitors and thus support and stimulate business and industry and promote the desirability of investment and occupancy in business, commercial and industrial properties.**
- (f) Stabilize and improve property values and prevent blighted areas and thus increase tax revenues.**
- (g) Achieve the beneficial influence of pleasant environments for living and working on behavioral patterns and thus decrease the cost of governmental services.**
- (h) Foster civic pride and community spirit so as to improve the quality and quantity of citizen participation in local government and in community growth, change and improvement.**
- (i) Sustain the comfort, health, safety, tranquility and contentment of residents and attract new residents by reason of the City's favorable environment and thus pro-mote and protect the peace, health and welfare of the City.**
- (j) Determine the appropriate yard setbacks, building heights, minimum lot sizes when authorized to do so by City ordinance.**

Response: The proposed development is a minor modification to an existing school campus. These modifications include mostly interior remodeling. Exterior alterations, including minor building additions, site landscaping and minor alterations to vehicle areas, have been designed to be compatible with existing design features of the site, including compliance with current Code requirements and design standards. Given the already built nature of the campus, the opportunities for originality, flexibility and innovation are somewhat limited. However, the architect has added features with an intent to provide some originality and innovation to the exterior design. Proposed design features are further specified in Exhibit J, Elevations and Predesign Report produced by Bassetti Architects. These design features help to discourage monotonous, drab, unsightly, dreary and inharmonious development.

Again, the proposal is essentially a renovation of the existing school campus, with most of the project focused on interior remodeling. The existing site was designed with features that promote natural beauty and visual character, including building design and landscaping throughout the site. The site also includes an extensive network of pedestrian pathways and bike facilities that encourage alternative modes of transportation. Natural features include a large, linear storm water facility between the school building and the main frontage along SW Boones Ferry Road. This feature will be augmented with removal of non-native or nuisance species and planted with new landscaping.

Overall, this school renovation project will enhance the educational experience for the students, staff and community by providing a more aesthetic stronger, clearer entry and efficient facility that better meets the changing needs of a modern high school. The renovation provides a greater level of visual character to both the interior and exterior of the campus buildings, and, therefore, a greater level of student and civic pride.

(3) In determining compliance with the requirements set forth, the Community Development Director shall consider the effect of his or her action on the availability and cost of needed housing. The Community Development Director shall not use the requirements of this section to exclude needed housing types. However, consideration of these factors shall not prevent the Community Development Director from imposing conditions of approval necessary to meet the requirements of this section. The costs of such conditions shall not unduly increase the cost of housing beyond the minimum necessary to achieve the purposes of this Code. As part of the Architectural Review process, the Community Development Director has no authority to reduce dwelling unit densities.

Response: This proposal does not include the development of new housing, nor does the proposal increase student enrollment or staff. Therefore, the cost of needed housing is not relevant to this proposal.

(4) As part of Architectural Review, the property owner may apply for approval to remove trees, in addition to those exemptions allowed in TDC 34.200(3), by submitting information concerning proposed tree removal, pursuant to TDC 34.210(1). The granting or denial of a tree removal permit shall be based on the criteria in TDC 34.230.

Response: Some trees will need to be removed as part of this Architectural Review application. The required information related to proposed tree removal has been submitted as part of this application package, including a Tree Preservation Plan and Landscape Plan. Some trees will be selectively removed adjacent to the new entry on the south side of the building, to help create a stronger sense of welcome and wayfinding, in contrast to the rows of cherry trees flanking the existing building.

(5) Conflicting Standards. In addition to the MUCOD requirements, the requirements in TDC Chapter 73 (Community Design Standards) and other applicable Chapters apply. If TDC Chapters 57, 73 and other applicable Chapters, conflict or are different, they shall be resolved in accordance with TDC 57.200(2).

Response: The applicant has addressed all applicable requirements, including specific responses to applicable sections of Chapter 73 and other relevant Chapters of TDC. The applicant understands that in the case of any conflicts or differences among applicable Code Chapters that those instances shall be resolved in accordance with TDC 57.200(2).

Section 73.100 Landscaping Installation and Maintenance

(1) All landscaping approved through the Architectural Review Process shall be continually maintained, including necessary watering, weeding, pruning and replacement, in a manner substantially similar to that originally approved through the Architectural Review Process, unless subsequently altered with Community Development Director approval.

(2) All building exterior improvements approved through the Architectural Review Process shall be continually maintained including necessary painting and repair so as to remain substantially similar to original approval through the Architectural Review Process, unless subsequently altered with Community Development Director approval.

Response: All proposed improvements in this application, including proposed new landscaping and exterior building improvements, are intended to be continually maintained by the owner.

Section 73.160 Standards.

The following standards are minimum requirements for commercial, industrial, public and semi-public development, and it is expected that development proposals shall meet or exceed these minimum requirements.

(1) Pedestrian and Bicycle Circulation.

(a) For commercial, public and semi-public uses:

- (i) a walkway shall be provided between the main entrance to the building and any abutting public right-of-way of an arterial or collector street where a transit stop is designated or provided. The walkway shall be a minimum of 6 feet wide and shall be constructed of concrete, asphalt, or a pervious surface such as pavers or grasscrete, but not gravel or woody material, and be ADA compliant, if applicable;**
- (ii) walkways shall be provided between the main building entrances and other on-site buildings and accessways. The walkways shall be a minimum of 6 feet wide and shall be constructed of concrete, asphalt, or a pervious surface such as pavers or grasscrete, but not gravel or woody material, and be ADA compliant, if applicable;**
- (iii) walkways through parking areas, drive aisles, and loading areas shall be visibly raised and of a different appearance than the adjacent paved vehicular areas;**
- (iv) accessways shall be provided as a connection from the development's internal bikeways and walkways to all of the following locations that apply: abutting arterial or collector streets upon which transit stops or bike lanes are provided or designated; abutting undeveloped residential or commercial areas; adjacent undeveloped sites where an agreement to provide an accessway connection exists; and to abutting publicly-owned land intended for general public use, including schools;**
- (v) fences or gates which prevent pedestrian and bike access shall not be allowed at the entrance to or exit from any accessway.**
- (vi) bikeways shall be provided which link building entrances and bike facilities on the site with the adjoining public right-of-way and accessways.**

Response:

There is an existing, comprehensive network on walkways, accessways and bike facilities within the Tualatin High School Campus. All existing walkways and accessways will continue to provide connections between the main entrance of the school and the public right-of-way (SW Boones Ferry Road). The connections between the main entrance and other on-site buildings and accessways will also be retained. No changes are proposed to existing parking areas as part of this application and proposal, nor are there any changes proposed to existing walkways crossing existing parking areas.

- (d) Accessways shall be a minimum of 8 feet wide and constructed in accordance with the Public Works Construction Code if they are public accessways, and if they are private access-ways they shall be constructed of asphalt, concrete or a pervious surface such as pervious asphalt or concrete, pavers or grasscrete, but not gravel or woody material, and be ADA compliant, if applicable.**

Response: There is new accessway proposed at the south sides of the existing school campus building. This is the only new accessway proposed. This accessway is over 20 feet wide, and is intended as the new secure entry into the school. The proposed surface composition of this accessway will be concrete or pavers.

(e) Accessways to undeveloped parcels or undeveloped transit facilities need not be constructed at the time the subject property is developed. In such cases the applicant for development of a parcel adjacent to an undeveloped parcel shall enter into a written agreement with the City guaranteeing future performance by the applicant and any successors in interest of the property being developed to construct an accessway when the adjacent undeveloped parcel is developed. The agreement shall be subject to the City's re-view and approval.

Response: There are no undeveloped parcels or transit facilities adjacent to the subject site, therefore, this standard does not apply.

(f) Where a bridge or culvert would be necessary to span a designated greenway or wetland to provide a connection to a bike or pedestrian path, the City may limit the number and location of accessways to reduce the impact on the greenway or wetland.

Response: No bridges or accessways are proposed as part of this application, therefore, this standard does not apply.

(g) Accessways shall be constructed, owned and maintained by the property owner.

Response: All proposed accessways will be constructed, owned and maintained by the property owner and/or tenant.

Section 73.220 Standards

The following standards are minimum requirements for commercial, industrial, public and semi-public development and it is expected that development proposals shall meet or exceed these minimum requirements.

(1) Safety and Security.

(a) Locate, orient and select on-site lighting to facilitate surveillance of on-site activities from the public right-of-way or other public areas without shining into public rights-of-way or fish and wildlife habitat areas.

Response: A limited amount of on-site lighting is proposed as part of this application and renovation/addition project. This lighting is associated with the proposed additions on the south and north sides of the existing building. None of this lighting will affect public rights-of-way due to distance and

blockage by existing structures. There are no fish and wildlife areas on the site.

(b) Provide an identification system which clearly identifies and locates buildings and their entries.

Response: There is an existing identification system for the school campus, which will be amended to reflect the new location of the new main entry on the south side of the building.

(c) Shrubs in parking areas shall not exceed 30 inches in height, and tree canopies must not extend below 8 feet measured from grade, except for parking structures and underground parking where this provision shall not apply.

Response: No landscaping is proposed for existing parking areas. All existing landscaping in parking areas will be preserved, with no proposed removal or additional plantings.

Section 73.227 Standards

The following standards are minimum requirements for mixed solid waste and source separated recyclables storage areas. To provide for flexibility in designing functional storage areas, this section provides four different methods to meet the objectives of providing adequate storage for mixed solid waste and source separated recyclables and improving the efficiency of collection. An applicant shall choose and implement one of the following four methods to demonstrate compliance: 1) minimum standards; 2) waste assessment; 3) comprehensive recycling plan; or 4) franchised hauler review, as more fully described in subsections (2), (3), (4) and (5) of this section.

(2) Minimum Standards Method. This method specifies a minimum storage area requirement based on the size and general use category of the new or expanded development. This method is most appropriate when specific use of a new or expanded development is not known. It provides specific dimensional standards for the minimum size of storage areas by general use category.

(a) The size and location of the storage area(s) shall be indicated on the site plan. Compliance with the requirements set forth below are reviewed through the Architectural Review process.

(v) Commercial, industrial, public and semi-public developments shall provide a minimum storage area of 10 square feet plus: Office - 4 square feet/1000 square feet gross leasable area (GLA); Retail - 10 square feet/1000 square feet GLA; Wholesale/ Warehouse/ Manufacturing - 6 square feet/1000 square feet GLA; Educational and institutional - 4 square feet/1000 square feet GLA; and other - 4 square feet/1000 square feet GLA.

Response: There is an existing mixed solid waste and source separated recyclables storage area on site. This area will continue to operate at the existing location on the site, with no proposal alter the facility. Staff has indicated that a franchise hauler letter is not required as part of the application. As an Educational use, the requirement for minimum storage area is 4 square feet per 1000 square feet of leasable area. The proposed leasable area of the development is 250,366 square feet. Therefore, the required leasable area is approximately 1002 square feet. The project includes a dedicated area for waste and recycling that is approximately 2,575 square feet. Therefore, this standard is met.

LANDSCAPING

Section 73.240 Landscaping General Provisions.

- (1) The following standards are minimum requirements.**
- (2) The minimum area requirement for landscaping for conditional uses for RL, RML, RMH, RH and RH/HR Planning Districts, listed in TDC 41.030, 42.030, 43.030 and 44.030, excluding 40.030(3), 40.030 (4)(j), 40.030 (4)(m), 40.030 (4)(n) and 41.030(2) shall be twenty-five (25) percent of the total area to be developed. When a dedication is granted in accordance with the planning district provisions on the subject property for a fish and wildlife habitat area, the minimum area requirement for landscaping shall be twenty (20) percent of the total area to be developed as determined through the AR process.**
- (9) Yards adjacent to public streets, except as described in the Hedges Creek Wetlands Mitigation Agreement, TDC 73.240(7), shall be planted to lawn or live groundcover and trees and shrubs and be perpetually maintained in a manner providing a park-like character to the property as approved through the Architectural Review process.**
- (10) Yards not adjacent to public streets or Low Density Residential (RL) or Manufacturing Park (MP) Planning Districts shall be planted with trees, shrubs, grass or other live groundcover, and maintained consistent with a landscape plan indicating areas of future expansion, as approved through the Architectural Review process.**
- (11) Any required landscaped area shall be designed, constructed, installed, and maintained so that within three years the ground shall be covered by living grass or other plant materials. (The foliage crown of trees shall not be used to meet this requirement.) A maximum of 10% of the landscaped area may be covered with un-vegetated areas of bark chips, rock or stone. Disturbed soils are encouraged to be amended to an original or higher level of porosity to regain infiltration and stormwater storage capacity.**

Response: No new landscaping is required as part of this proposal and application. The applicant is not required to upgrade the minimum landscape area (percentage) of the site. However, the applicant is proposing to both remove some existing trees and landscaping in those areas proposed for additional building. The applicant is proposing to mitigate for those removed trees, and plant new trees and landscaping in those areas of development. These additional plantings and landscaping will meet the applicable standards of Section 73.240. The overall

proposed percentage of landscaping of the Tualatin High School site is 40%. This percentage meets the 25% minimum landscape percentage requirement. Again, the applicant is not required to upgrade the minimum landscape area (percentage) of the site, and the applicant is proposing new landscaping only in those areas associated with the building additions and the existing swale along SW Boones Ferry Road. The existing swale along SW Boones Ferry Road is within the front setback, and this front yard setback area within the swale will be slightly regraded and re-landscaped. The rest of the front yard area is planted with lawn or other groundcover and/or bushes and trees, and these plantings will be preserved. All other required landscaped areas on other portions of the site will be preserved.

Section 73.260 Tree and Plant Specifications

(1) The following specifications are minimum standards for trees and plants:

(a) Deciduous Trees:

Deciduous shade and ornamental trees shall be a minimum one and one-half inch (1 1/2") caliper measured six inches (6") above ground, balled and burlapped. Bare root trees will be acceptable to plant during their dormant season. Trees shall be characteristically shaped specimens.

(b) Coniferous Trees.

Coniferous trees shall be a minimum five feet (5') in height above ground, balled and burlapped. Bare root trees will be acceptable to plant during their dormant season. Trees shall be well branched and characteristically shaped specimens.

(c) Evergreen and Deciduous Shrubs.

Evergreen and deciduous shrubs shall be at least one (1) to five (5) gallon size. Shrubs shall be characteristically branched. Side of shrub with best foliage shall be oriented to public view.

(d) Groundcovers.

Groundcovers shall be fully rooted and shall be well branched or leafed. English ivy (*Hedera helix*) is considered a high maintenance material which is detrimental to other landscape materials and buildings and is therefore prohibited.

(e) Lawns.

Lawns shall consist of grasses, including sod, or seeds of acceptable mix within the local landscape industry. Lawns shall be 100 percent coverage and weed free.

(2) Landscaping shall be installed in accordance with the provisions of Sunset New Western Garden Book (latest edition), Lane Publishing Company, Menlo Park, California or the American Nurserymen Association Standards (latest edition).

(3) The following guidelines are suggested to ensure the longevity and continued vigor of plant materials:

- (a) Select and site permanent landscape materials in such a manner as to produce a hardy and drought-resistant landscaped area.
 - (b) Consider soil type and depth, spacing, exposure to sun and wind, slope and contours of the site, building walls and overhangs, and compatibility with existing native vegetation preserved on the site or in the vicinity.
- (4) All trees and plant materials shall be healthy, disease-free, damage-free, well-branched stock, characteristic of the species.
- (5) All plant growth in landscaped areas of developments shall be controlled by pruning, trimming or otherwise so that:
- (a) It will not interfere with designated pedestrian or vehicular access; and
 - (b) It will not constitute a traffic hazard because of reduced visibility.

Response: All of the proposed conifer and deciduous trees proposed for planting comply with the standards identified herein. All of the proposed shrubs (evergreen and deciduous), groundcovers and lawns proposed for planting also comply with the standards identified herein. Installation and maintenance are also intended to comply with the standards identified herein. See Tree Preservation and Removal Plan and Landscape Planting Plan in the Plan Set, Exhibit B.

Section 73.280 Irrigation System Required.

Except for townhouse lots, landscaped areas shall be irrigated with an automatic underground or drip irrigation system.

Response: An irrigation system is proposed. This system is identified in the Tree Preservation and Removal Plan and Landscape Planting Plan in the Plan Set, Exhibit B.

Section 73.290 Re-vegetation in Un-landscaped Areas

The purpose of this section is to ensure erosion protection, and in appropriate areas to encourage soil amendment, for those areas not included within the landscape percentage requirements so native plants will be established, and trees will not be lost.

- (1) Where vegetation has been removed or damaged in areas not affected by the landscaping requirements and that are not to be occupied by structures or other improvements, vegetation shall be replanted.
- (2) Plant materials shall be watered at intervals sufficient to ensure survival and growth for a minimum of two growing seasons.
- (3) The use of native plant materials is encouraged to reduce irrigation and maintenance demands.
- (4) Disturbed soils should be amended to an original or higher level of porosity to regain infiltration and stormwater storage capacity.

Response: The applicant is proposing to both remove some existing trees and landscaping in those areas proposed for additional building. The applicant is proposing to mitigate for those removed trees, and plant new trees and landscaping in those areas of development. These additional plantings and landscaping will meet the applicable

standards of Section 73.240 and 73.290. See Tree Preservation and Removal Plan and Landscape Planting Plan in the Plan Set, Exhibit B, for more details.

Section 73.310 Landscape Standards - Commercial, Industrial, Public and Semi-Public Uses.

- (1) A minimum 5-foot-wide landscaped area must be located along all building perimeters which are viewable by the general public from parking lots or the public right-of-way, excluding loading areas, bicycle parking areas and pedestrian egress/ingress locations. Pedestrian amenities such as landscaped plazas and arcades may be substituted for this requirement. This requirement shall not apply where the distance along a wall between two vehicle or pedestrian access openings (such as entry doors and pedestrian corridors) is less than 8 feet.**
- (2) Areas exclusively for pedestrian use that are developed with pavers, bricks, etc., and contain pedestrian amenities, such as benches, tables with umbrellas, children's play areas, shade trees, canopies, etc., may be included as part of the site landscape area requirement.**
- (3) All areas not occupied by buildings, parking spaces, driveways, drive aisles, pedestrian areas or undisturbed natural areas shall be landscaped.**

Response: The applicant is proposing to both remove some existing trees and landscaping in those areas proposed for additional building. The applicant is proposing to mitigate for those removed trees, and plant new trees and landscaping in those areas of development. These additional plantings and landscaping will meet the applicable standards of Section 73.240 and 73.290. This includes a 5-foot perimeter of landscaping along new building additions. See Tree Preservation and Removal Plan and Landscape Planting Plan in the Plan Set, Exhibit B, for more details.

Section 73.340 Off-Street Parking Lot and Loading Area Landscaping – Commercial, Industrial, Public and Semi-Public Uses, and Residential and Mixed Use Residential Uses within the Central Design District.

Section 73.360 Off-Street Parking Lot Landscape Islands - Commercial, Industrial, Public, and Semi-Public Uses.

Response: No new parking is proposed and none is required. As indicated in the Traffic Report dated October 24, 2017, there will be no new trips generated with the proposed development and exterior alterations, therefore, no changes to parking areas are required nor proposed.

Section 73.410 Street Tree Plan

Response: The applicant is not required to add additional street trees, nor is the applicant proposing to plant additional street trees. Therefore, a Street Tree Plan is not applicable.

TREE REMOVAL AND PRESERVATION

Section 34.210 Application for Architectural Review, Sub-division or Partition Review, or Tree Removal Permit

(1) **Architectural Review, Subdivision, or Partition.** When a property owner wishes to remove trees, other than the exemptions permitted under TDC 34.200(3), to develop property, and the development is subject to Architectural Review, Subdivision Review, or Partition Review approval, the property owner shall apply for approval to remove trees as part of the Architectural Review, Subdivision Review, or Partition Review application process.

(a) The application for tree removal shall include:

- (i) A Tree Preservation Site Plan, drawn to a legible scale, showing the following information: a north arrow; existing and proposed property lines; existing and proposed topographical contour lines; existing and proposed structures, impervious surfaces, wells, septic systems, and stormwater retention and/or detention facilities; existing and proposed utility and access locations and/or easements; illustration of vision clearance areas; and illustration of all trees on-site that are eight inches or more in diameter (including size, species, and tag i.d. number). All trees proposed for removal and all trees proposed for preservation shall be indicated on the site plan as such by identifying symbols, except as follows:
- (ii) A tree assessment prepared by a qualified arborist, including the following information: an analysis as to whether trees proposed for preservation can in fact be preserved in light of the development proposed, are healthy specimens, and do not pose an imminent hazard to persons or property if preserved; an analysis as to whether any trees proposed for removal could be reasonably preserved in light of the development proposed and health of the tree; a statement addressing the approval criteria set forth in TDC 34.230; and arborist's signature and contact information. The tree assessment report shall have been prepared and dated no more than one calendar year proceeding the date the development application is deemed complete by the City. Where TDC 34.210(1)(a)(i)(A) through (D) are applicable, trees located within the CWS-required easement need not be included in the tree assessment report.
- (iii) All trees on-site shall be physically identified and numbered in the field with an arborist-approved tagging system. The tag i.d. numbers shall correspond with the tag i.d. numbers illustrated on the site plan. Where TDC 34.210(1)(a)(i)(A) through (D) are applicable, trees located in the CWS-required easement need not be tagged.

Response: A Tree Preservation and Removal Plan and Landscape Planting Plan have been provided as part of this application. See Plan Set, Exhibit B, for more details. In addition, a tree inventory and assessment report has also been provided as part of this application. See Arborist Report, Exhibit I for more details.

(b) The application for tree removal shall be approved or denied based on the criteria in TDC 34.230.

Response: The criteria for tree removal is addressed below in Section 34.230.

(c) The approval or denial of an application to remove trees shall be a part of the Architectural Review, Subdivision Review, or Partition Review decision.

Response: The application for tree removal is part of this Architectural Review application and will also be part of the decision.

Section 34.230 Tree Removal Criteria

(1) An applicant must satisfactorily demonstrate that any of the following criteria are met:

(a) The tree is diseased, and

(b) The tree represents a hazard which may include but not be limited to:

(c) It is necessary to remove the tree to construct proposed improvements based on Architectural Review approval, building permit, or approval of a Subdivision or Partition Review.

Response: The applicant must remove the trees proposed for removal based on the requirements of the additions proposed as part of the renovation project. Based on the Site Plan and Tree Preservation and Removal Plan in the Plan Set (Exhibit B), as well as the Arborist Report in Exhibit I, the 19 trees proposed for removal would continue to diminish the prominence of the entryway, and confuse visitors as to where the main building entry, including the reception and administration areas. The District and their architect believe removing a selected few cherry trees at this new entry will provide a more robust entry way for the arrival of visitors, students and staff.

Section 73.250 Tree Preservation

(1) Trees and other plant materials to be retained shall be identified on the landscape plan and grading plan.

(2) During the construction process:

(a) The owner or the owner's agents shall provide above and below ground protection for existing trees and plant materials identified to remain.

(b) Trees and plant materials identified for preservation shall be protected by chain link or other sturdy fencing placed around the tree at the drip line.

(c) If it is necessary to fence within the drip line, such fencing shall be specified by a qualified arborist as defined in TDC 31.060.

- (d) Neither top soil storage nor construction material storage shall be located within the drip line of trees designated to be preserved.
- (e) Where site conditions make necessary a grading, building, paving, trenching, boring, digging, or other similar encroachment upon a preserved tree's drip-line area, such grading, paving, trenching, boring, digging, or similar encroachment shall only be permitted under the direction of a qualified arborist. Such direction must assure that the health needs of trees within the preserved area can be met.
- (f) Tree root ends shall not remain exposed

Response: All of the requirements listed in this Section are conveyed in the Tree Preservation and Removal Plan and Grading Plan in the Plan Set in Exhibit B.

GRADING

Section 73.270 Grading

- (1) After completion of site grading, top-soil is to be restored to exposed cut and fill areas to provide a suitable base for seeding and planting.
- (2) All planting areas shall be graded to provide positive drainage.
- (3) Neither soil, water, plant materials nor mulching materials shall be allowed to wash across roadways or walkways.
- (4) Impervious surface drainage shall be directed away from pedestrian walkways, dwelling units, buildings, outdoor private and shared areas and landscape areas except where the landscape area is a water quality facility.

Response: All grading proposed for the building additions will be managed based on the Grading Plan in Exhibit B.

TDC Chapter 70: Flood Plain District (FP)

Response: The proposed development area is not in the Flood Plain District, therefore, the standards and criteria in this District are not applicable.

TDC Chapter 71: Wetlands Protection District (WPD)

Response: The proposed development area is not in the Wetlands Protection District, therefore, the standards and criteria in this District are not applicable.

TDC Chapter 72: Natural Resource Protection Overlay District (NRPO)

Response: The proposed development area is not in the Natural Resource Protection Overlay District, therefore, the standards and criteria in this District are not applicable.

OFF-STREET PARKING AND LOADING

Section 73.370 Off-Street Parking and Loading

(1) General Provisions.

- (a) At the time of establishment of a new structure or use, or change in use, or change in use of an existing structure, within any planning district of the City, off-street parking spaces, off-street vanpool and carpool parking spaces for commercial, institutional and industrial uses, off-street bicycle parking, and off-street loading berths shall be as provided in this and following sections, unless greater requirements are otherwise established by the conditional use permit or the Architectural Review process, based upon clear findings that a greater number of spaces are necessary at that location for protection of public health, safety and welfare or that a lesser number of vehicle parking spaces will be sufficient to carry out the objectives of this section. In the Central Design District, the Design Guidelines of TDC 73.610 shall be considered. In case of conflicts between guidelines or objectives in TDC Chapter 73, the proposal shall provide a balance.

Response: This proposal does not include establishment of a new structure or use, or change in use, or change in use of an existing structure, therefore, off-street parking spaces, off-street vanpool and carpool parking spaces for commercial, institutional and industrial uses, off-street bicycle parking, and off-street loading berths are not required to be provided in this and the following sections of this Chapter. Based on the Traffic Report in Exhibit H, there are no substantial addition of trips associated with the proposed development. The applicant is also not anticipating any increases in enrollment or staff as part of this renovation project.

(2) Off-Street Parking Provisions.

- (a) The following are the minimum and maximum requirements for off-street motor vehicle parking in the City, except for minimum parking requirements for the uses in TDC 73.370(2)(a) (Residential Uses: iii, iv, v, vi, vii; Places of Public Assembly: I, ii, iv; Commercial Amusements: I, ii; and Commercial: I, ii, xi, xii, xiv) within the Core Area Parking District (CAPD). Minimum standards for off-street motor vehicle parking for the uses in 73.370(2) (a) Residential Uses: iii, iv, v, vi, vii; Places of Public Assembly: I, ii, iv; Commercial Amusements: I, ii; and Commercial: I, ii, xi, xii, xiv in the CAPD are in TDC 73.370(2)(b).

The maximum requirements are divided into Zone A and Zone B, as shown on the Tualatin Parking Zone Map, Figure 73-3. The following are exempt from calculation of maximum parking requirements: parking structures; fleet parking; parking for vehicles for sale, lease or rent; car/vanpool parking; dedicated valet parking; and user-paid parking.

USE	MINIMUM MOTOR VEHICLE PARKING REQUIREMENT	MAXIMUM MOTOR VEHICLE PARKING REQUIREMENT	BICYCLE PARKING REQUIREMENT	PERCENTAGE OF BICYCLE PARKING TO BE COVERED
(iii) Senior high school	0.2 spaces per student and staff	Zone A and Zone B: 0.3 spaces per student plus 1.00 space per staff	4, or 1.00 space per 5 students based on the design capacity of the facility, whichever is greater	25

Response: There are 588 existing parking spaces at the school site campus. No changes to the number of parking spaces is proposed. There are approximately 1991 students and 150 staff at the school site campus. Based on these numbers and the requirements indicated in the Parking Table in Section 73.380, there are 428 vehicle parking spaces required. The existing parking meets the minimum parking requirements identified in this Section.

This proposal does not include establishment of a new structure or use, or change in use, or change in use of an existing structure, therefore, off-street parking spaces, off-street vanpool and carpool parking spaces for commercial, institutional and industrial uses, off-street bicycle parking, and off-street loading berths are not required to be provided in this and the following sections of this Chapter. Based on the Traffic Report in Exhibit H, there are no substantial addition of trips associated with the proposed development. The applicant is also not anticipating any increases in enrollment or staff as part of this renovation project.

Section 73.380 Off-Street Parking Lots.

A parking lot, whether an accessory or principal use, intended for the parking of automobiles or trucks, shall comply with the following:

Response: This proposal does not include establishment of a new structure or use, or change in use, or change in use of an existing structure, therefore, off-street parking spaces, off-street vanpool and carpool parking spaces for commercial, institutional and industrial uses, off-street bicycle parking, and off-street loading berths are not required to be provided in this and the following sections of this Chapter. Based on the Traffic Report in Exhibit H, there are no substantial addition of trips associated with the proposed development.

Section 73.390 Off-Street Loading Facilities

- (1) The minimum number of off-street loading berths for commercial, industrial, public and semi-public uses**
- (2) Loading berths shall conform to minimum size specifications.**

Response: No changes are proposed for the existing off-street loading facilities at the high school site. The existing facilities are adequate to serve the site. In addition, City staff indicated in the Pre-Application Meeting that a letter from the franchise hauler would not be required.

Section 73.400 Access

(11) Minimum Access Requirements for Commercial, Public and Semi-Public Uses.

In the Central Design District, when driveway access is on local streets, not collectors or arterials and the building(s) on the property is(are) less than 5,000 square feet in gross floor area, or parking is the only use on the property, ingress and egress shall not be less than 24 feet. In all other cases, ingress and egress for commercial uses shall not be less than the following:

Over 250 Required Parking Spaces, Minimum Number Required, Minimum Pavement Width and Minimum Pavement Walkways, Etc. – no specific minimums, all as required by City Engineer.

Response: There are (2) two-way access driveways fronting on Boones Ferry Road. The north access driveway is 36 feet wide and the south access driveway is 36 feet wide. Both driveways provide 2-way access. These 2 driveways are proposed to be retained. Improvements to these 2 driveways include replacement of existing non-compliant ADA ramps and measures to improve lighting to help with safety and wayfinding. No additional access driveway or closures of existing access driveways has been required by the City Engineer.

Section 74.210 Minimum Street Right-of-Way Widths.

The width of streets in feet shall not be less than the width required to accommodate a street improvement needed to mitigate the impact of a proposed development. In cases where a street is required to be improved according to the standards of the TDC, the width of the right-of-way shall not be less than the minimums indicated in TDC Chapter 74, Public Improvement Requirements, Figures 74-2A through 74-2G.

(2) For development applications other than subdivisions and partitions, wherever existing or future streets adjacent to property proposed for development are of inadequate right-of-way width, the additional right-of-way necessary to comply with TDC Chapter 74, Public Improvement Requirements, Figures 74-2A through 74-2G of the Tualatin Community Plan shall be dedicated to the City for use by the public prior to issuance of any building permit for the proposed development. This right-of-way dedication shall be for the full width of the property abutting the roadway and, if required by the City Engineer, additional dedications shall be provided for slope and utility easements if deemed necessary.

Response: There is only one right-of-way adjacent to the subject property that provides access to the site, which is SW Boones Ferry Road. SW Boones Ferry Road is considered a Major Arterial under TDC Chapter 74, Public Improvement Requirements, and within Figures 74-2A through 74-2G of the Tualatin Community Plan. The minimum and preferred right-of-way cross sections are identified in these figures. The minimum right-of-way cross section width is 70 feet and the preferred width is 98 feet. The current cross section configuration for the school site frontage along SW Boones Ferry Road includes a 75 foot-wide right-of-way, including 45 feet on the Applicants side. This exceeds the minimum right-of-way cross section standard for a Major Arterial.

Section 74.420 Street Improvements.

When an applicant proposes to develop land adjacent to an existing or proposed street, including land which has been excluded under TDC 74.220, the applicant should be responsible for the improvements to the adjacent existing or proposed street that will bring the improvement of the street into conformance with the Transportation Plan (TDC Chapter 11), TDC 74.425 (Street Design Standards), and the City’s Public Works Construction Code, subject to the following provisions:

Response: The applicant is proposing redevelopment of an existing school site that does not include additional students or staff. Therefore, there is no generation of additional traffic associated with this proposal. In the Traffic Impact Analysis by Kittelson dated October 24, 2017, the study concludes that, ‘the proposed school project will have no measurable impact at the existing school driveways off of SW Boones Ferry Road because 1) no increase in current student enrollment capacity is accommodated by the proposed changes and 2) no changes to the site access, circulation, or parking are proposed. Further, because the existing school driveways operate in accordance with City standards, no capacity-based transportation mitigation measures are needed to support the proposed project.’ However, driveway improvements will be completed as part of this project including replacement of ADA ramps and improved lighting.

Section 74.425 Street Design Standards.

(1) Street design standards are based on the functional and operational characteristics of streets such as travel volume, capacity, operating speed, and safety. They are necessary to ensure that the system of streets, as it develops, will be capable of safely and efficiently serving the traveling public while also accommodating the orderly development of adjacent lands.

(2) The proposed street design standards are shown in Figures 72A through 72G. The typical roadway cross sections comprise the following elements: right-of-way, number of travel lanes, bicycle and pedestrian facilities, and other amenities such as landscape strips. These figures are intended for planning purposes for new road construction, as well as for those locations where it is physically and economically feasible to improve existing streets.

(3) In accordance with the Tualatin Basin Program for fish and wildlife habitat it is the intent of Figures 74-2A through 74-2G to allow for modifications to the standards when deemed appropriate by the City Engineer to address fish and wildlife habitat.

(4) All streets shall be designed and constructed according to the preferred standard. The City Engineer may reduce the requirements of the preferred standard based on specific site conditions, but in no event will the requirement be less than the minimum standard. The City Engineer shall take into consideration the following factors when deciding whether the site conditions warrant a reduction of the preferred standard:

(a) Arterials:

(i) Whether adequate right-of-way exists

(ii) Impacts to properties adjacent to right-of-way

(iii) Current and future vehicle traffic at the location

(iv) Amount of heavy vehicles (buses and trucks).

Response: There is only one right-of-way adjacent to the subject property that provides access to the site, which is SW Boones Ferry Road. SW Boones Ferry Road is considered a Major Arterial under TDC Chapter 74, Public Improvement Requirements, and within Figures 74-2A through 74-2G of the Tualatin Community Plan. The minimum and preferred right-of-way cross sections are identified in these figures. The minimum right-of-way cross section width is 70 feet and the preferred width is 98 feet. The current cross section configuration for the school site frontage along SW Boones Ferry Road includes a 75 foot-wide right-of-way, including 45 feet of right-of-way on the applicant side. This meets the minimum right-of-way cross section standard for a Major Arterial. As part of the existing cross-section, there are 3 motor vehicle travel lanes, sidewalk and striped bike lanes, which provide design elements that substantially comply with the Major Arterial minimum standards indicated in Figures 74-2A through 74-2G of the Tualatin Community Plan.

Though the preferred right-of-way cross section does not currently exist, the applicant is proposing redevelopment of an existing school site that does not include additional students or staff. Therefore, there is no generation of additional traffic. Since there is no generation of additional traffic, there are no substantial off-site impacts on the adjacent right-of-way and transportation system associated with the proposed development. Therefore, there is no nexus, including the measurement of rough proportionality, for exacting off-site roadway improvements based on off-site impacts.

Section 74.430 Streets, Modifications of Requirements in Cases of Unusual Conditions.

(1) When, in the opinion of the City Engineer, the construction of street improvements in accordance with TDC 74.420 would result in the creation of a hazard, or would be impractical, or would be detrimental to the City, the City Engineer may modify the scope of the required improvement to eliminate such hazardous, impractical, or detrimental results. Examples of conditions requiring modifications to improvement requirements include but are not limited to horizontal alignment, vertical alignment, significant stands of trees, fish and wildlife habitat areas, the amount of traffic generated by the proposed development, timing of the development or other conditions creating hazards for pedestrian, bicycle or motor vehicle traffic. The City Engineer may determine that, although an improvement may be impractical at the time of development, it will be necessary at some future date. In such cases, a written agreement guaranteeing future performance by the applicant in installing the required improvements must be signed by the applicant and approved by the City.

(2) When the City Engineer determines that modification of the street improvement requirements in TDC 74.420 is warranted pursuant to subsection (1) of this section, the City Engineer shall prepare written findings of modification. The City Engineer shall forward a copy of said findings and description of modification to the applicant, or his authorized agent, as part of the Utility Facilities Review for the proposed development, as provided by TDC 31.072. The decision of the City Engineer may be appealed to the City Council in accordance with TDC 31.076 and 31.077.

(3) To accommodate bicyclists on streets prior to those streets being upgraded to the full standards, an interim standard may be implemented by the City. These interim standards include reduction in motor vehicle lane width to 10 feet [the minimum specified in AASHTO's A Policy on Geo-metric Design of Highways and Streets (1990)], a reduction of bike lane width to 4-feet (as measured from the longitudinal gutter joint to the centerline of the bike lane stripe), and a paint-stripped separation 2 to 4 feet wide in lieu of a center turn lane. Where available roadway width does not provide for these minimums, the roadway can be signed for shared use by bicycle and motor vehicle travel. When width constraints occur at an intersection, bike lanes should terminate 50 feet from the intersection with appropriate signing.

Response: The City Engineer has not identified any unusual circumstances that would warrant modification of any required street improvements. Again, though the preferred right-of-way cross section does not currently exist, the applicant is proposing redevelopment of an existing school site that does not include additional students or staff. Therefore, there is no generation of additional traffic. Since there is no generation of additional traffic, there are no substantial off-site impacts on the adjacent right-of-way and transportation system associated with the proposed development. Therefore, there is no nexus, including the measurement of rough proportionality, for exacting off-site roadway improvements based on off-site impacts.

Section 74.440 Streets, Traffic Study Required.

(1) The City Engineer may require a traffic study to be provided by the applicant and furnished to the City as part of the development approval process as provided by this Code, when the City Engineer determines that such a study is necessary in connection with a proposed development project in order to:

(a) Assure that the existing or proposed transportation facilities in the vicinity of the proposed development are capable of accommodating the amount of traffic that is expected to be generated by the proposed development, and/or

(b) Assure that the internal traffic circulation of the proposed development will not result in conflicts between on-site parking movements and/or on-site loading movements and/or on-site traffic movements, or impact traffic on the adjacent streets.

Response: The applicant has provided a Traffic Impact Analysis (TIA) that was prepared by Kittelson and is dated October 24, 2017. This study identifies the generation of impacts associated with the proposed development, as well as any needed mitigation associated with the impacts. The conclusion of the study substantially indicates that there are no impacts associated with the proposed development, therefore, no impact mitigation is required. In addition, Kittelson has prepared 2 additional letters that address comments from the City Engineer regarding transportation improvements and lighting. These 2 letters are part of the completeness resubmittal application and are dated December 8, 2017. These letters indicate the issues associated with access for the subject property, including the inadequacy of lighting at the 2 access driveways serving the site. The applicant proposes new lighting at these access driveways. Lighting design will be provided for City review with progression of the project.

Section 74.470 Street Lights.

(1) Street light poles and luminaries shall be installed in accordance with the Public Works Construction Code.

(2) The applicant shall submit a street lighting plan for all interior and exterior streets on the proposed development site prior to issuance of a Public Works Permit.

Response: Kittelson has prepared a letter that addresses existing lighting on the site in the form of a photometric analysis. This letter is included as part of the completeness resubmittal application and is dated December 8, 2017. This letter indicates the lighting issues associated with access for the subject property, including the inadequacy of lighting at the 2 access driveways serving the site. The applicant proposes new lighting at these access driveways. This lighting will comply with the standards of the Public Works Construction Code, including installation.

Section 74.630 Storm Drainage System.

(1) Storm drainage lines shall be installed to serve each property in accordance with City standards. Storm drainage construction plans and calculations shall be submitted to the City Engineer for review and approval prior to construction.

(2) The storm drainage calculations shall confirm that adequate capacity exists to serve the site. The discharge from the development shall be analyzed in accordance with the City's Storm and Surface Water Regulations.

(3) If there are undeveloped properties adjacent to the proposed development site which can be served by the storm drainage system on the proposed development site, the applicant shall extend storm drainage lines to the common boundary line with these properties. The lines shall be sized to convey expected flows to include all future development from all up stream areas that will drain through the lines on the site, in accordance with the Tualatin Drainage Plan in TDC Chapter 14.

Response: There is an existing, permanent on-site stormwater quantity detention facility, designed in accordance with this title, located at the front of the site between the existing building and SW Boones Ferry Road. This facility qualifies as a technique that satisfies the requirement for mitigating the impacts of development upon the public storm water quantity system. See Storm Water Plan in the Plan Set, Exhibit B, as well as Storm Water Report, Exhibit F.

Section 74.640 Grading.

(1) Development sites shall be graded to minimize the impact of storm water runoff onto adjacent properties and to allow adjacent properties to drain as they did before the new development.

(2) A development applicant shall submit a grading plan showing that all lots in all portions of the development will be served by gravity drainage from the building crawl spaces; and that this development will not affect the drainage on adjacent properties. The City Engineer may require the applicant to remove all excess material from the development site.

Response: A Grading Plan has been provided as part of this application and is part of the overall Plan Set, Exhibit B.

Section 74.650 Water Quality, Storm Water Detention and Erosion Control.

The applicant shall comply with the water quality, storm water detention and erosion control requirements in the Surface Water Management Ordinance. If required:

(1) On subdivision and partition development applications, prior to approval of the final plat, the applicant shall arrange to construct a permanent on-site water quality

facility and storm water detention facility and submit a design and calculations indicating that the requirements of the Surface Water Management Ordinance will be satisfied and obtain a Stormwater Connection Permit from Clean Water Services; or

(2) On all other development applications, prior to issuance of any building permit, the applicant shall arrange to construct a permanent on-site water quality facility and storm water detention facility and submit a design and calculations indicating that the requirements of the Surface Water Management Ordinance will be met and obtain a Stormwater Connection Permit from Clean Water Services.

(3) For on-site private and regional non-residential public facilities, the applicant shall submit a stormwater facility agreement, which will include an operation and maintenance plan provided by the City, for the water quality facility for the City's review and approval. The applicant shall submit an erosion control plan prior to issuance of a Public Works Permit. No construction or disturbing of the site shall occur until the erosion control plan is approved by the City and the required measures are in place and approved by the City.

Response: There is an existing, permanent on-site stormwater quantity detention facility, designed in accordance with this title, located at the front of the site between the existing building and SW Boones Ferry Road. This facility qualifies as a technique that satisfies the requirement for mitigating the impacts of development upon the public storm water quantity system. See Storm Water Plan in the Plan Set, Exhibit B, as well as Storm Water Report, Exhibit F.

Section 75.120 Existing Streets.

The following list describes in detail the freeways and arterials as defined in TDC 75.030 with respect to access. Recommendations are made for future changes in accesses and location of future accesses. These recommendations are examples of possible solutions and shall not be construed as limiting the City's authority to change or impose different conditions if additional studies result in different recommendations from those listed below.

(8) BOONES FERRY ROAD

(g) Ibach Street to Norwood Road:

Development of these residential properties shall result in no more than two driveway accesses for Tualatin High School, one emergency access with no curb cut for Grahams Landing Townhomes Condos (Tax Lot 2S1 35BA 90000) and only street intersections for other properties. All street intersections on Boones Ferry Road between Ibach and Norwood shall be spaced a minimum of 500 feet apart.

Response: There are two existing driveway accesses serving the site, and no new driveway accesses are proposed. These 2 existing driveway accesses are approximately 685 feet apart, therefore, the minimum spacing standard is met.

TUALATIN MUNICIPAL CODE

3-5-050 Erosion Control Permits

(1) Except as noted in subsection (3) of this section, no person shall cause any change to improved or unimproved real property that causes, will cause, or is likely to cause a temporary or permanent increase in the rate of soil erosion from the site without first obtaining a permit from the City and paying prescribed fees. Such changes to land shall include, but are not limited to, grading, excavating, filling, working of land, or stripping of soil or vegetation from land.

(2) No construction, land development, grading, excavation, fill, or the clearing of land is allowed until the City has issued an Erosion Control Permit covering such work, or the City has determined that no such permit is required. No public agency or body shall undertake any public works project without first obtaining from the City an Erosion Control Permit covering such work, or receiving a determination from the City that none is required.

Response: The applicant has provided a preliminary Erosion Control and Grading Plan as part of the plan set (Exhibit B) in this application for purposes of preliminary review by Engineering. In addition, the applicant proposes to apply for an erosion control permit subsequent to Architectural Review, anticipating that this requirement will also be a condition of approval. The application for the Erosion Control Permit will follow the requirements listed under Section 3-5-060, Permit Process.

3-5-200 Downstream Protection Requirement.

Each new development is responsible for mitigating the impacts of that development upon the public storm water quantity system. The development may satisfy this requirement through the use of any of the following techniques, subject to the limitations and requirements in TMC 3-5-210:

(1) Construction of permanent on-site stormwater quantity detention facilities designed in accordance with this title;

(2) Enlargement of the downstream conveyance system in accordance with this title and the Public Works Construction Code;

(3) The payment of a Storm and Surface Water Management System Development Charge, which includes a water quantity component designated to meet these requirements.

Response: There is an existing, permanent on-site stormwater quantity detention facility, designed in accordance with this title, located at the front of the site between the existing building and SW Boones Ferry Road. This facility qualifies as a technique that satisfies the requirement for mitigating the impacts of development upon the

public storm water quantity system. Further analysis of downstream protection is addressed below.

3-5-210 Review of Downstream System.

For new development other than the construction of a single family house or duplex, plans shall document review by the design engineer of the downstream capacity of any existing storm drainage facilities impacted by the proposed development. That review shall extend downstream to a point where the impacts to the water surface elevation from the development will be insignificant, or to a point where the conveyance system has adequate capacity, as determined by the City Engineer.

To determine the point at which the downstream impacts are insignificant or the drainage system has adequate capacity, the design engineer shall submit an analysis using the following guidelines:

- (1) evaluate the downstream drainage system for at least ¼ mile;**
- (2) evaluate the downstream drainage system to a point at which the runoff from the development in a build out condition is less than 10 percent of the total runoff of the basin in its current development status. Developments in the basin that have been approved may be considered in place and their conditions of approval to exist if the work has started on those projects;**
- (3) evaluate the downstream drainage system throughout the following range of storms: 2, 5, 10, 25 year;**
- (4) The City Engineer may modify items 1, 2, 3 to require additional information to determine the impacts of the development or to delete the provision of unnecessary information.**

If the increase in surface waters leaving a development will cause or contribute to damage from flooding, then the identified capacity deficiency shall be corrected prior to development or the development must construct onsite detention. To determine if the runoff from the development will cause or contribute to damage from flooding the City Engineer will consider the following factors:

- (1) The potential for or extent of flooding or other adverse impacts from the run-off of the development on downstream properties;**
- (2) The potential for or extent of possibility of inverse condemnation claims;**
- (3) Incremental impacts of runoff from the subject and other developments in the basin; and**
- (4) Other factors that may be relevant to the particular situation.**

The purpose of the City Engineer's review is to protect the City and its inhabitants from the impacts or damage caused by runoff from development while recognizing all appropriate limitations on exactions from the development.

Response: Clean Water Services requires a downstream analysis to evaluate downstream capacity. In the event of a capacity issue, on-site detention is required up to the specific range of storms where the downstream capacity issue is present. Because the site is within the Hedges Creek Sub-basin, the impacted area will be adequately detained, such that the post-developed 2-year, 10-year, and 25-year flows are less than or equal to the corresponding pre-developed 2-year, 10-year, and 25-year flows. This proposed detention complies with Tualatin Municipal Code 3-5-210 by way of 3-5-220(4). The proposed detention also complies with Clean Water Services Design and Construction Standards for Sanitary Sewer and Surface Water Management Section 4.03.4(b). These requirements were conveyed to the applicant by the City of Tualatin through an email from Tony Doran dated October 2, 2017. This email specifically indicated that the Hedges Creek basin requires detention up to the 25-year storm. Due to the fact that detention is already required, no effort was made for a downstream analysis, as the design is already complies with what is required by CWS in the event of a downstream deficiency.

4-2-010 Hydrants and Water Supply for Fire Protection.

(1) Every application for a building permit and accompanying plans shall be submitted to the Building Division for review of water used for fire protection, the approximate location and size of hydrants to be connected, and the provisions for access and egress for firefighting equipment. If upon such review it is determined that the fire protection facilities are not required or that they are adequately provided for in the plans, the Fire and Life Safety Reviewer shall recommend approval to the City Building Official.

(2) If adequate provisions for such facilities are not made, the Fire and Life Safety Reviewer shall either recommend against approval of the plans or indicate to the applicant in writing where the plans are deficient or recommend approval of plans subject to conditions.

4-2-020 Access to Hydrants Located on Private Property.

(1) For the purpose of prescribing regulations and governing conditions hazardous to life and property from fire or explosion, the 2007 State of Oregon Fire Code as adopted by the Oregon State Fire Marshal's Office and Tualatin Valley Fire and Rescue Ordinance No. 07-01 is adopted as part of this Code.

(2) The 2007 State of Oregon Fire Code Handbook, a companion document to the Uniform Fire Code, as adopted by Tualatin Valley Fire & Rescue Ordinance No. 07-01, is adopted as part of this Code.

Response: The applicant has coordinated with City staff Building Division, as well as representatives from Tualatin Valley Fire and Rescue. The coordination has focused on fire/life/safety issues related to the school property overall, with the intent to insure the adequacy of facilities that will provide water supply intended for fire protection. This includes identification of existing and proposed fire hydrants, as well as existing and proposed access ways for fire trucks and other emergency vehicles. Details for both fire hydrants and emergency access is indicated on various sheets within the Plan Set, Exhibit B.

CONCLUSION

The request for an Architectural Review approval for the proposed high school renovation and addition project meets all applicable code provisions as addressed in this project narrative and in the attached application submittal materials. Therefore, the applicant respectfully requests Architectural Review approval of the proposed building renovation and associated site development.

MEMORANDUM



To: Aquilla Hurd-Ravich, Principal
Planner

From: Kevin Brady
Senior Planner

Date: December 15, 2017

Project: Tualatin High School Modification
Re: City of Tualatin Incompleteness Letter
AR17-0011

6720 SW Macadam Ave.
Suite 200
Portland, OR 97219

Phone (503) 419-2500
Fax (503) 419-2600

www.cardno.com

The applicant has received the Tualatin High School completeness letter received Tuesday, 11/14, from the City of Tualatin. We have reviewed and discussed the letter internally at Cardno and want to provide the following response and associated action items. These responses are intended to provide direction and guidance to the team in responding to each of the items identified in the letter, as well as with the revised plan sets, binders and other required application material.

In addition, the applicant has included all required materials related to the additional review of the athletic fields component of the project. Per direction from staff, the applicant understands that this component will be reviewed as part of the existing application.

The case file is AR17-0011 and was originally submitted October 26, 2017. Generally, the letter states that an application has been submitted for Architectural Review (AR) for the proposed modifications at Tualatin High School at 22300 SW Boones Ferry Road. The letter advises that the land use application has been deemed incomplete in accordance with the Tualatin Development Code (TDC) Subsection 31.072 and Oregon Revised Statutes (ORS) 227.178., and that the time period in which the City must take final action is suspended pending resolution of the items listed below. The letter contains the completeness review for both the City of Tualatin Planning and Engineering Divisions and finds the following items to be incomplete or missing from the application:

1. Narrative. The supplied narrative was insufficient in terms of addressing how your proposed development is consistent with or complies with pertaining to Mixed Solid Waste and Source Separated Recyclables Storage Areas under TDC 73.227. The simplest and most common method used to satisfy this requirement is by calculating required storage area size via the minimum standards method using the rates listed in TDC 73.227(2)(v) to ensure that the existing storage facilities are of adequate size to accommodate the proposed increase in building floor area.

Response: Floor areas for the school have been calculated, as well as area calculations for existing waste/recycling storage areas. The required storage area under TDC 73.227 is 4 square feet/1000 square feet GLA (gross leasable area) for educational and institutional uses. Compliance with this standard is met and is reflected in the revised narrative.

The City of Tualatin Engineering Division finds the following items to be incomplete or missing from your application (please ask questions as needed and respond to the following to have a complete and robust application and narrative):

2. Transportation.

- a. Please provide queues. The City receives complaints that traffic regularly backs up between SW Ibach Street and the access to the high school. Include identification of queues, evaluation with any mitigation, and include this in narrative responses to code.

Response: This project will serve existing and projected student population, and is not intended to increase student capacity (per letter from TTSD as described in the narrative), therefore this project is not adding capacity to traffic on SW Boones Ferry Road. The applicant has provided letters that update the existing traffic report to include queues and associated evaluation. The applicant has also incorporated this information from the report into the narrative.

- b. Washington County Safety Priority Index System doesn't include roads that aren't under county jurisdiction, so the roads in the study would not be eligible to be on the list.

Response: The traffic engineer has confirmed that this safety index is not relevant to this project and no action is needed, as the reference did not impact the validity or the contents of the report.

3. Pedestrian and Bicycle.

- a. Because a high school typically generates pedestrian and bicycle traffic, include evaluation and any mitigation. Propose improvements to address onsite circulation and assess multi-modal traffic interactions such as routes for pedestrians to not cross the north access at SW Boones Ferry Road at the right-of-way but further back on site.

Response: The applicant's traffic engineer has reiterated in the traffic report/letters that there will be a no-net increase in pedestrian or bicycle traffic. The applicant has provided a Concept Plan to indicate the overall site circulation plan.

- b. Because pedestrians use both sides of SW Boones Ferry Road, address the sidewalk gap on the west side.

Response: The applicant has reviewed the sidewalk gap, including rough proportionality issues, whether the gap detrimentally impacts pedestrian circulation and whether there is an alternative route that avoids the gap. The gap is not detrimental to overall circulation, as indicated by the applicant's traffic engineer in the associated response letter. This response letter and revised application package material also indicate that this issue/deficiency is not TTSD responsibility.

- c. Provide evaluation of the condition of the sidewalk adjacent to the high school to indicate if it is in good condition and meets Public Right-of-Way Accessibility Guidelines. If not, indicate where repairs will be performed or improvements will occur to meet Public Right-of-Way Accessibility Guidelines.

Response: Survey for this work is still pending. The applicant has conducted a preliminary evaluation of the sidewalk adjacent to the high school to identify locations of non-compliance. Portions of the public sidewalk exceed allowable cross-slope, and each of the four ramps at the access points do not meet current code compliance. The applicant has indicated these deficiencies will be corrected with this project.

4. Evaluate street lights to verify that the existing illumination may be inadequate per Public Works Construction Code. This is especially important at the accesses to SW Boones Ferry Road. Evaluate and provide narrative to indicate if the current illumination meets code or if additional street lights are needed.

Response: The applicant has provided a photometric analysis for the areas associated with both access driveways at Boones Ferry Road. The photometric study is included in this revised application and in the revised narrative. Existing lighting at the driveways is insufficient to meet City code. The applicant will work with the City to resolve this issue as the design progresses.

5. Tualatin Valley Fire & Rescue (TVF&R) identified a covered walkway blocking an existing emergency access easement near the auditorium. Please work with TVF&R to determine how to meet their requirements.
 - a. Show routes for emergency vehicles in accordance with TVF&R's easements and requirements.

Response: The applicant has worked with TVF&R and reviewed this issue with the owner. The solution to best address TVF&R concerns at the lowest cost is to enhance the route around the Auditorium. Cardno will revise the plan set showing this access.

- b. If any stormwater treatment and detention is required for construction of any new or modified impervious surfaces for emergency needs, incorporate ramifications within the stormwater calculations and reflect them on plans.

Response: The applicant has revised the plan set and stormwater calculations, as necessary or applicable. Increased impervious areas are accounted for in the storm design.

6. Public stormwater and sanitary sewer lines exist on the high school property near SW Boones Ferry Road. Private trees exist and are proposed near these lines. The existing lines may have become damaged or could become damaged during construction.
 - a. Provide TV reports for the existing stormwater and sanitary sewer lines for the public indicating their condition.

Response: The applicant understands that the City will require public utility lines be TV'd upon project completion. The applicant proposes that lines will be TV'd and the information provided to the City prior to construction.

- b. If the lines are damaged, include plans to repair these lines.

Response: The applicant understands it will be the responsibility of TTSD to protect existing utility lines or repair damages caused by construction on TTSD property.

- c. Locate proposed trees outside the public easements. If any proposed tree is near the public easements, indicate the need to add root barriers that are 2 feet deep and 10 feet wide centered on the tree.

Response: The applicant is proposing to relocate proposed trees outside easement locations based on current title report. Incorporation of the title report into an expanded survey is not yet complete. Once resolved, tree placement recommendations from the City will be met with an updated plan set.

- d. Rerouting the public utilities may be an option. This may be easiest to remove public easements conflicting with your development plans. Confirmation of the proposed locations will be needed from the City. Appropriate conveyance calculations will be needed. The preferred location is within right-of-way. Please let us know and work with us if you choose this direction.

Response: The applicant does not propose to reroute utilities. However, the applicant has revised plans to reduce or eliminate conflicts with existing easements.

7. Stormwater calculations and plans show and confirm adequate treatment and detention within the vicinity of work for the proposed Architectural Review.
 - a. Provide evaluation per Clean Water Services (CWS) Design and Construction Standards 4.05.5.c modification of existing development for the site. CWS considers the site to be the entire tax lot on which work is performed. Provide evaluation to gradually help non-conforming existing conditions gradually catch up to current code.

Response: In further discussions with the City, additional explanation of compliance to City/CWS requirements has been garnered. The narrative has been revised, including verification that the standards are met.

- b. Include conveyance calculations including discussion of downstream and any improvements if needed per Tualatin Municipal Code 3-5.210.

Response: The revised narrative and storm water report provide further explanation as to how the project meets CWS requirements.

8. Provide more in depth narrative for the Engineering portion of the land use application narrative. Provide narrative for the following sections of Tualatin Municipal Code (TMC) and Tualatin Development Code (TDC).
 - a. TMC 3-5 Erosion control, stormwater
 - b. TMC 4-1 Fire hydrants and TVF&R requirements
 - c. TDC 73.400 Access location, widths, spacing from intersections
 - d. TDC 74
 - i. .210, .420, .425, .430, .440 Street cross-sections and improvements from the transportation impact analysis
 - ii. .470 Street lights
 - iii. .640 grading
 - iv. .630 and .650. stormwater
 - e. TDC 75.120(8)(g) Existing accesses

Response: The applicant has revised the narrative to address all of these Sections indicated above. The revised narrative is reflective of the position and strategy developed by the applicant in response to each of the completeness items identified above.

AR17-0011

To lessen the bulk of the notice of application and to address privacy concerns, this sheet substitutes for the photocopy of the mailing labels. A copy is available upon request.